



CONTACT US



WWW.CYCROWN.COM



SUPPORT@CYCROWN.COM

CycFree
USER MANUAL

Contents

	What's Included in the Box	01
	Installation	02
	How to Charge the Battery	07
	Drive Modes	09
	Display and Buttons	10
	For Your Safety	15
	Battery Maintenance	16
	Storage	17
	Scrap Disposal	17
	Specification	18
	Warranty	19
	Contact Us	20



PRODUCT OVERVIEW

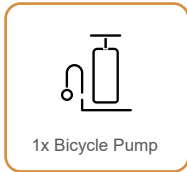
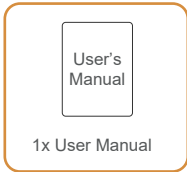
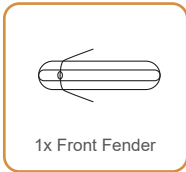
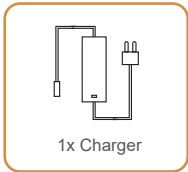
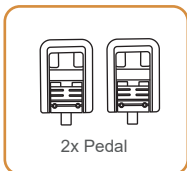
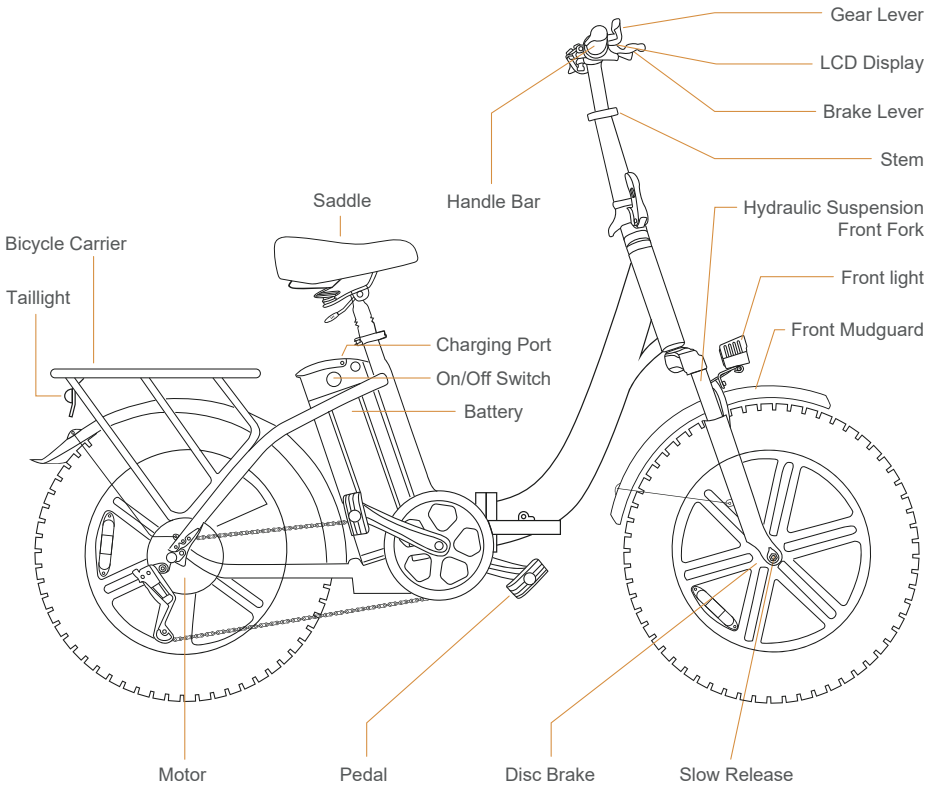

Check the parts and accessories carefully. If there are missing or damaged parts/accessories, please contact online customer service support.



Installation

Before Installation

- Please read this manual thoroughly and follow its instructions.
- Make sure all parts are intact.
- Do not install the battery or start the computer until the bike is fully installed.
- If you have any questions or can't find the information you need in the manual, please contact us via email.



Step 1 Stem Installation

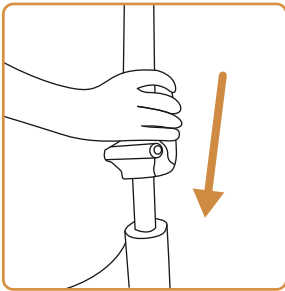

1 Insert the stem into the head tube.

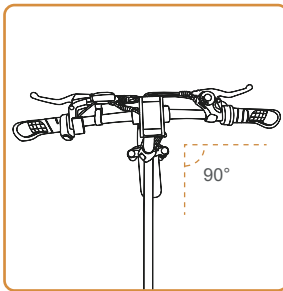

2 Adjust the handlebar to make it perpendicular to the front tire.

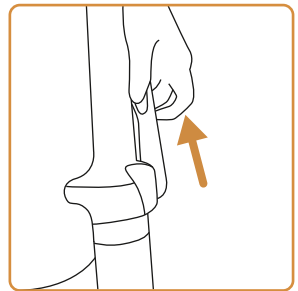

3 Open the folding lock.

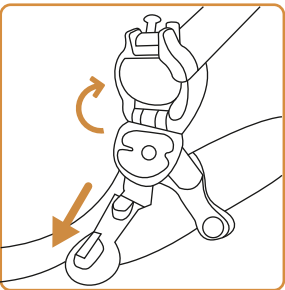

4 Put down the stem.

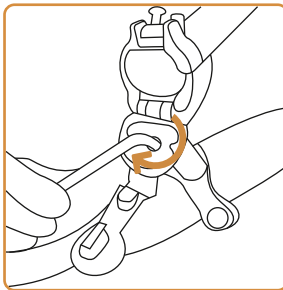

5 Tighten the bolt into the head tube.

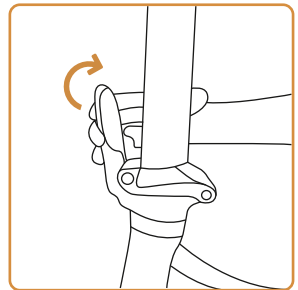

6 After tightening the bolt, Lift the stem and close the folding lock firmly.



Step 2 Handlebar Angle Adjustment

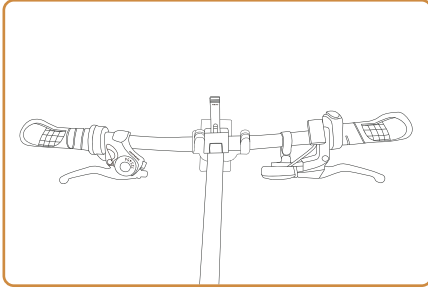

- 1 To adjust the handlebar angle, Open the quick release connecting the handlebar and stem.

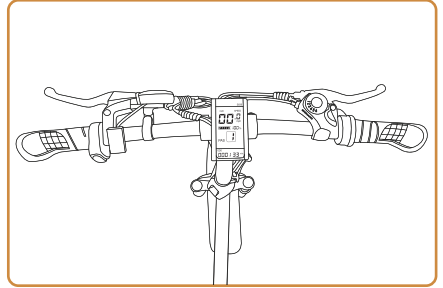

- 2 Make sure the handlebar is perpendicular to the front wheel.



Step 3 Front Wheel Installation

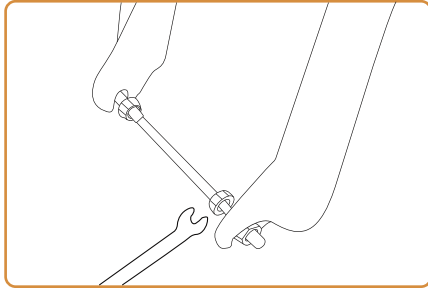

- 1 After taking out the front wheel, remove the front fork from the fork mount

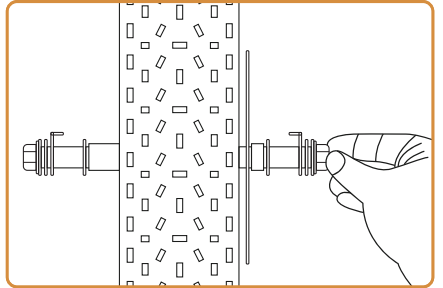

- 2 Insert the front axle into the wheel hub from one side and install the bushings, spacers, safety hooks, spacers, and nuts on the axle in sequence from both sides

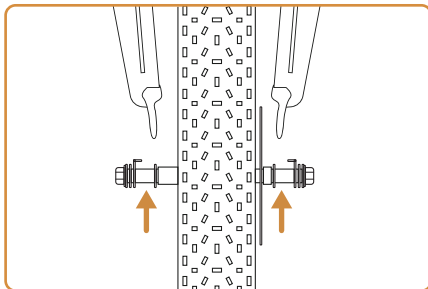

- 3 Lower the front fork onto the front wheel with the bushings and spacers located on the inside of the front fork dropouts. Make sure the brake caliper grips the brake rotor

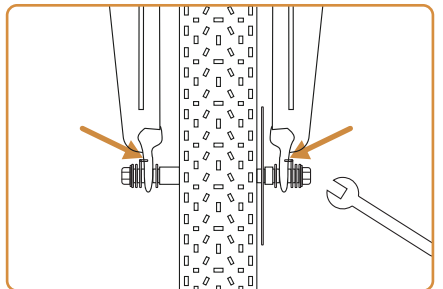

- 4 Adjust the safety hook to hook the front fork, and check that the front fork dropouts, safety hooks, spacers, and nuts are in sequence from the wheel hub to the outside. After ensuring the correct order, tighten the nuts with wrenches



Warnings:

- The disc brake is located on the left side in the direction of riding.
- Make sure the front wheel hub is fully engaged into the front fork drop-outs.
- Ensure that the circumference of the front wheel is completely caught in the drop-outs of the front fork, and tighten the nuts on both sides.



Step 4 Front Light and Mudguard Installation

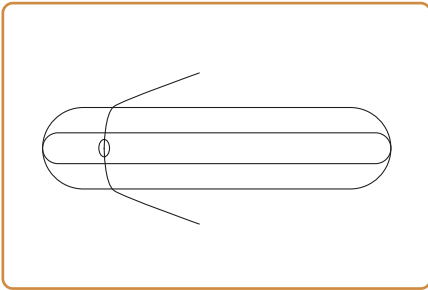

1

Take out the front fender and remove the nuts, washers and bolts on the top and bottom of the front fork.

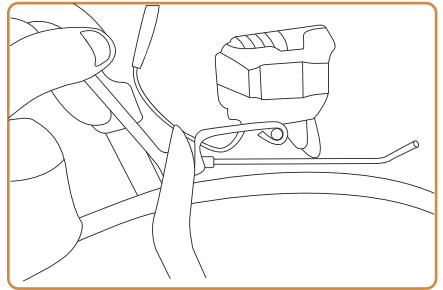

2

Put the fender through the front fork. Reinstall the bolts, washers and nuts (in this order). Reinstall the lower fender screws.

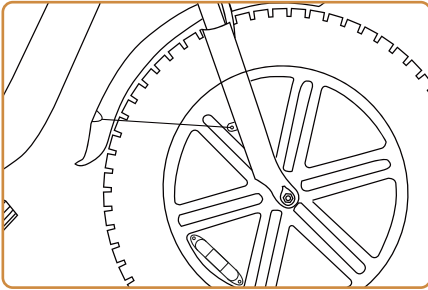

3

Put screws into the front light bracket and align.

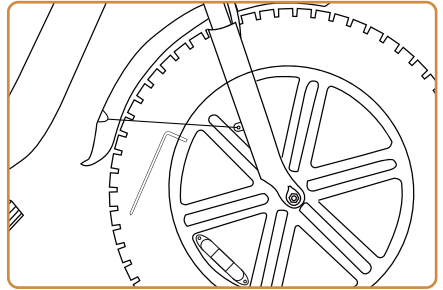

4

Tighten the screws with the hex key and wrench.



Step 5 Pedal Installation

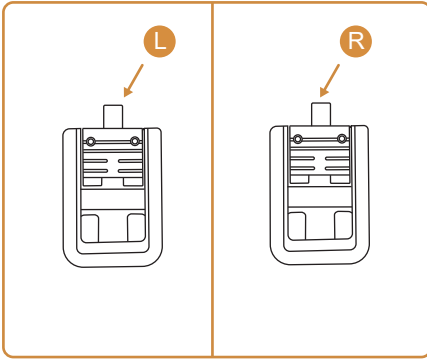

1 Identify the correct side by finding 'R' and 'L' marks on the pedals.

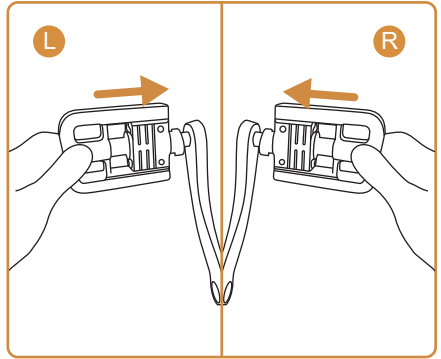

2 Press the pedals firmly by hand first. Tighten the right pedal clockwise and the left pedal counterclockwise.

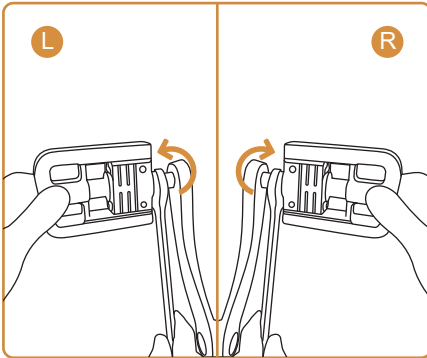

3 Fully tighten the pedals with a pedal wrench or open-end wrench.

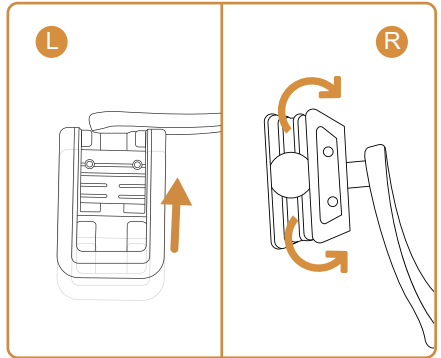

4 Push the pedal inward to fold the pedals up or down.



Step 6 Seat Installation

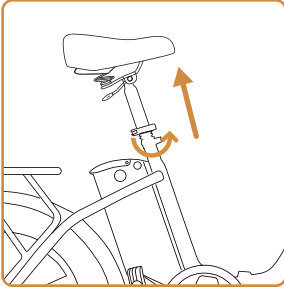

- 1** Open the QR seatpost clamp and adjust the seat height by pulling up or pressing down the seat.



- 2** Close the seatpost clamp and make sure the seatpost is held in place. Don't adjust the seat too high (keep the safety line mark lower than the top of the seat tube).

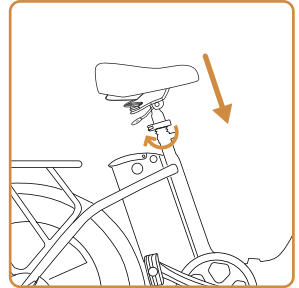

- 3** Loosen the seat clamp and adjust the seat to an appropriate angle.



Step 7 Battery Removal and Installation

(For your convenience, the bike battery can be removed.)

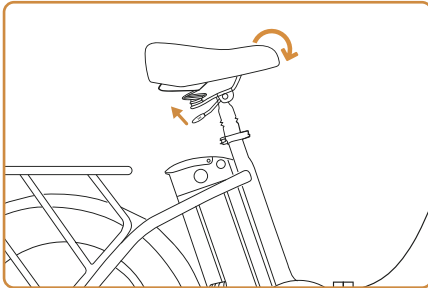

- 1** Insert the battery key, Turn it to the unlocked position.

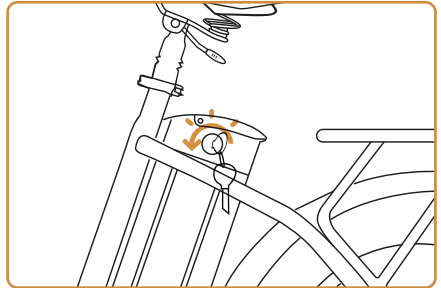

- 2** The battery is installed into the frame and can be taken out from the folded position of the frame.



To reinstall the battery, align the slot on the bottom of the battery and reinsert the battery into the frame. Turn the key to the locked position. If you want to know the battery level without turning the power on, long press the button on the top of the battery to display the current battery level.

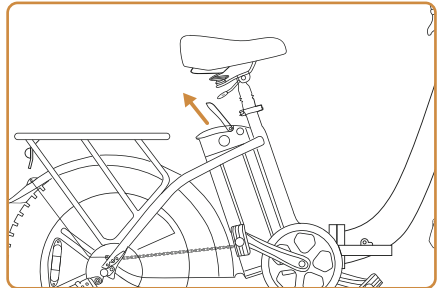

- 3** The battery is installed into the frame and can be taken out from the folded position of the frame.



How to Charge the Battery

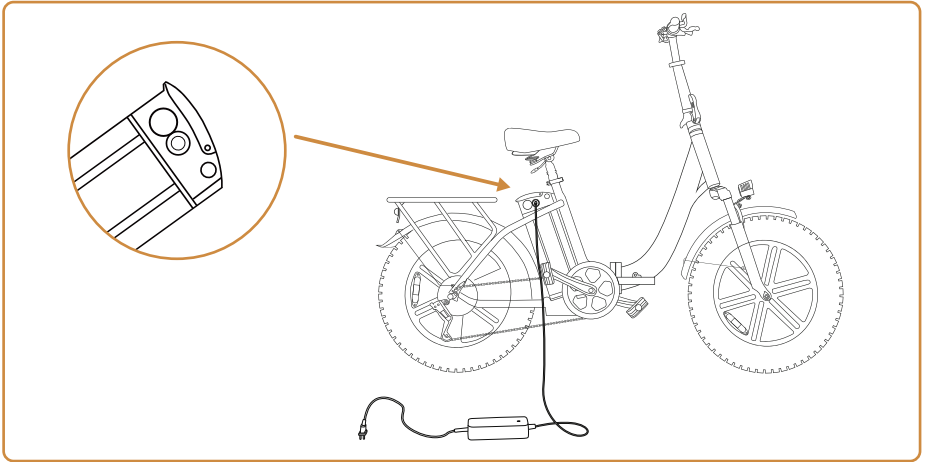

1

Make sure the power is turned off and check the connection of the charging cable and power adapter.

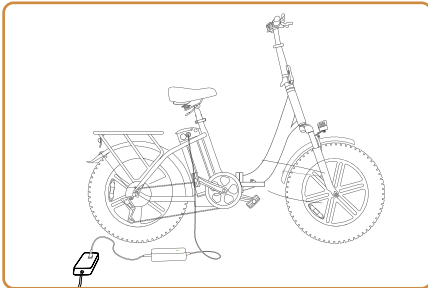

2

Plug the charger AC plug into a wall socket (100V-240V), and plug the DC connector into the electric bike's charging port.

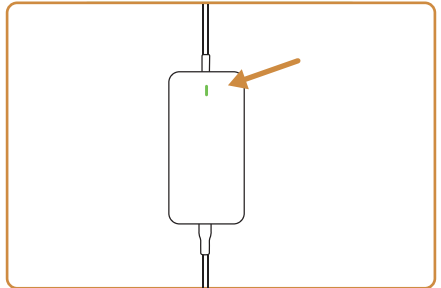

3

After charging for about 7 hours, the indicator light of the power adapter will change from red to green. Disconnect all cables when charging is complete.



Charge your e-bike before the first ride. It takes about 7 hours to fully charge the battery.



For your convenience, the battery can also be charged when removed from the CYCROWN CycFree e-bike.



Battery Safety

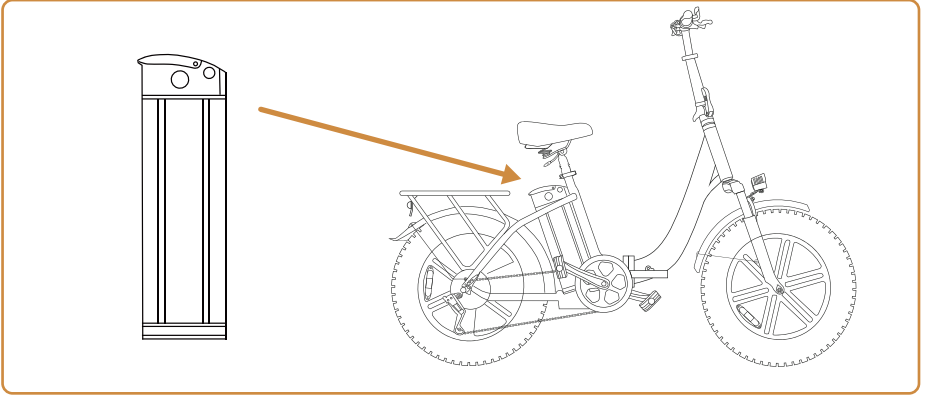

- Please fully charge the battery before first use. It takes 7 hours.
- Periodically visually inspect the battery connector and charging cable.
- Always keep the charging environment clean and dry.
- Do not charge the e-bike if there is liquid on the charging port.
- Avoid charging your e-bike in extremely hot or cold conditions to take full advantage of the battery's maximum efficiency. Under no circumstances should you use the bike while it is charging or connected to a charger.
- The charging time is about 7 hours. Prolonged charging may reduce battery life and performance.
- Only use the charger that comes with the e-bike. If the official charger is lost or damaged, Please contact Customer Service for a replacement.
- Before using the e-bike, Be sure to lock the battery with the provided battery key and remove the battery key.



Drive Modes

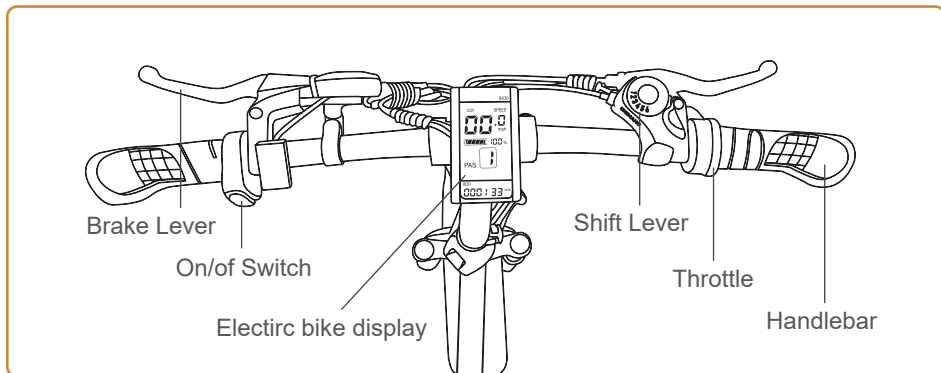

Drive Modes	Twist Throttle	Pedal Assist
0	×	×
1-5	✓	✓
Display OFF	×	×

Twist Throttle

Turn on the LCD smart display and you can switch the speed by twisting the throttle with speed mode from 1 to 5.

Gear	Twist Throttle	Pedal Assist
1	9.5 MPH	9.5 MPH
2	12.9 MPH	12.9 MPH
3	15.6 MPH	15.6 MPH
4	19.1 MPH	19.1 MPH
5	20.1 MPH	20.1 MPH

PAS

Turn on the LCD smart display and you can pedal it with PAS level from 1 to 5.

Pedal

Turn off the LCD smart display and you can pedal the E-Bike like a normal bike.

- Fully charge the battery before riding and make sure the battery switch is in on position.
- Press and hold the power button for 2 seconds to power on the electric bike.
- Top speed (in throttle mode) is 20 MPH (32 KM/H).
- Switch between gears by pressing the gear button or pushing the gear lever. The gear button can only increase the gear level.
- Stop: Release the accelerator and squeeze the brake lever to slow the front and rear wheels.



Display and Buttons

Computer display

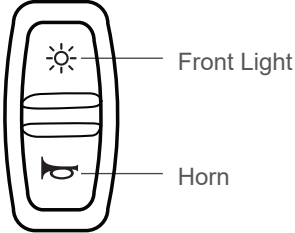
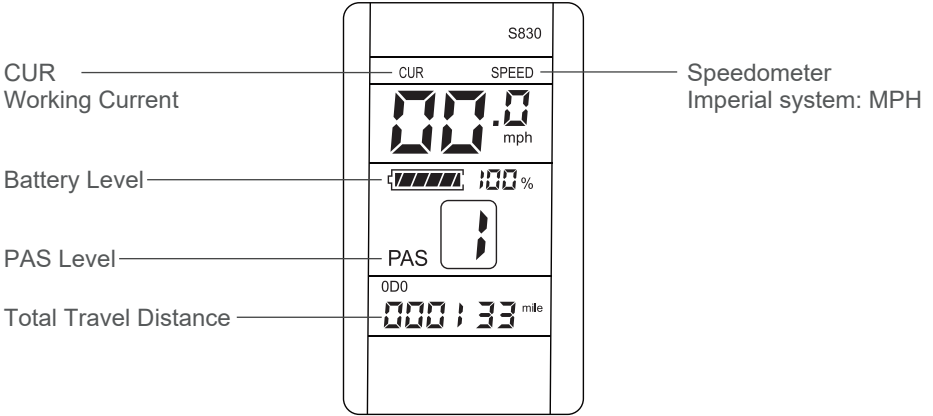

Front Light & Horn Button

- Press to turn on/off the front light
- Press or hold to activate the horn

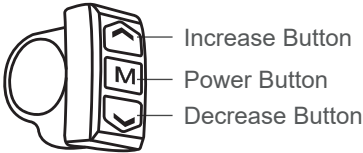

M Button

- Press to switch speed mode from 1 to 5.
- Press and hold for 2 seconds to power on/off the electric bike.
- Press to switch speed mode from 5 to 1.

Functions

- 1. On the display

Speed, PAS level, Battery level, Fault indicator, Total travel distance, Trip distance, Front light sign, Trip time.

- 2. Control and Settings







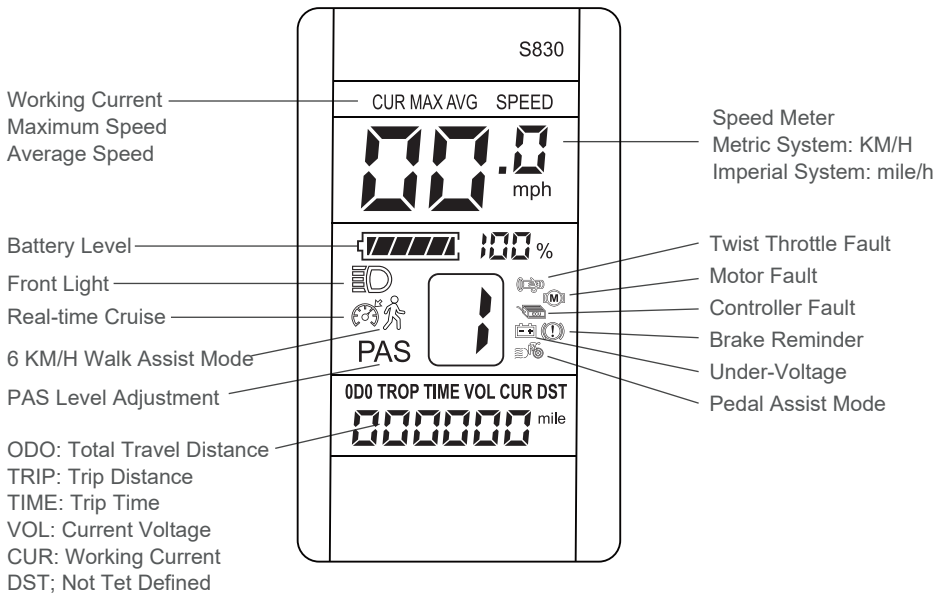





Power on/off control, Front light on/off control, 6 KM/H walk assist mode control, Wheel diameter setting, Top speed setting, Auto sleep time setting, backlight brightness setting, Voltage level setting.

- 3. UART Communication protocol: UART

All On-board Information (With in 1s After Power On)



Functions

		3.1 Front Light					
		3.2 Battery Level					
		3.3 Multi-Function Section					
		3.4 PAS Level					
		3.5 MAX: Trip max. Speed AVG: Average Speed The Meter will Calculate the Real Speed According to the Wheel Diameter and Signal Data					
							
6 KM/H Walk Assist Mode	Real-Time Cruise	Battery Under-Voltage	Motor Fault	Throttle Fault	Controller Fault	Brake Reminder	PAS Mode

Code	Meaning
0	Normal
1	Keep
2	Brake
3	PAS Fault (Riding Sign)
4	6 KM/H Cruise
5	Real-time Cruise
6	Battery Under-Voltage
7	Motor Fault
8	Throttle Fault
9	Controller Fault
10	Communication Receiving Fault
11	Communication Transmitting Fault
12	BMS Communication Fault
13	Front Light Fault

Setting

- P01: Backlight brightness: Level 1 means the darkest and level 3 means the brightest.
- P02: 0: KM; 1: MILE; Odometer unit.
- P08: Speed limit: 0-50 KM/H, 50 means no speed limit.

1.Non-communication state (computer control): When the speed is higher than the set speed, The PWM output will be turned off; When the speed drops below the set speed, The PWM output will be automatically turned on, And the drive speed is the current speed ± 1 KM/H (No speed limit in throttle mode)

2.Communication state (Controller control): The drive speed is maintained at the set value, Error: ± 1 KM/H (Both PAS mode and throttle mode have speed limit)

Note: The speed limit value here is based on the unit of KM/H. After the unit is switched from KM/H to MPH, The speed value on the display will automatically be converted to the correct MPH value. But if the value set in this menu is based on the unit of MPH, After the unit is switched to KM/H, The value will not be converted;

- P16: Zeroing: Press and hold the increase button for 5 seconds to reset ODO.

Description of Button Operations

Button operations include short pressing one button, Long pressing one button, And long pressing multiple buttons simultaneously.

Short press is used for fast and frequent operations, Such as:

- 1. In riding, Short press the buttons to change PAS level or speed limit.
- 2. In riding, Short press the M button to switch to multi-function section.
Long pressing the M button is mainly used to switch mode and power on/off.
Long pressing multiple buttons is used for parameter setting, Because the operation is complicated, it can reduce misoperation.

⚠ There is no short pressing multiple buttons which is easy to trigger and difficult to operate.

Specific Operation Instructions:

- 1. Change PAS level or speed limit.

(Assuming it is in PAS drive mode)

1.1 Short press  ,PAS level + 1.

1.2 Short press  ,PAS level - 1.

- 2. Switch speed unit.

Long press **M** +  ,Switch speed unit.

- 3. Enable/disable 6 KM/H walk assist mode, Turn on/off front light, Zero ODO.

When the bike is stationary, Press and hold the decrease button to enter walk assist mode, Letting it go will exit walk assist mode.

When in P16 menu interface, Long press increase button for 5 seconds to reset the odometer.

- 4. Turn on/off LCD display.

If the display is on, Long press the M button will turn it off; If the display is off, Long press to turn it on.

- 5. Switch multi-function section information.

Short press to switch items in multi-function section.

- 6. Parameter setting.

Long press the increase button + decrease button to enter parameter setting interface, You can set parameters such as wheel diameter (inch), Number of magnetic steel, LCD brightness, And under-voltage value (See setting: P01-P16);

(In setting interface, Short press the increase button or decrease button to adjust the value. The parameters will blink after adjustment.)

6.1 Long press the M button to save the current value and the parameter stops blinking.

6.2 Short press the M button to switch to the next parameter and the value of the previous parameter will be saved.

6.3 Press the increase button and decrease button to exit setting and save the parameters. If no operation for 10 seconds, It will exit and save the parameters automatically.



For Your Safety

For safe riding, Please read the following information carefully. Before riding, Be sure to check that your brakes are working properly.

Before Your First Ride

- Check whether the quick-release screws and seat are firm, And whether the brakes are effective.
- Check seat, Gears, And tire pressure. Proper tire inflation can reduce flat tires and improve performance, Including distance traveled per inflation.
- Check the handlebar and screws at least weekly.
- Performing the above routine checks before and after each ride can help you keep your bike performing at peak performance and spot potential problems before they become a safety hazard.

Bike Mechanic Check Every Six Months

- Bikes require regular maintenance. Take your bike to your local bike shop twice a year for tuning. Critical components should be inspected frequently, Repaired and adjusted by an experienced mechanic.

Notice

- Wear an approved helmet and other protective equipment to reduce any possible injury.
- Helmets can reduce serious head injuries by 85%.
- Elbow pads can reduce elbow injuries by 82%.
- Knee pads can reduce knee injuries by 32%.

Warning

- To avoid accidental movement while waiting at a traffic light, set the speed mode to zero, or apply brakes.
- When riding, Make sure your feet are always on the pedals and your hands on the handlebars. It is dangerous to take your feet off the pedals in riding.
- Never ride the electric bike for dangerous actions. Failure to exercise good judgment or heed the above warning increases the risk of serious injury and, In rare cases, death.
- Make sure the battery is fully charged, Especially for long trips.
- For your own safety and the safety of others, Obey the speed limit, Ride at a speed you are comfortable with, And be prepared to stop at any time.
- Keep a safe distance from other riders to avoid collisions.

- Be aware of your surroundings and avoid obstacles and unsafe surfaces.
- Ride in the open and flat. Try to avoid slopes or places with many pedestrians.
- Do not ride at high speeds, On uneven terrains, In bad weather or in other unsafe conditions.
- Never use the electric bike for anything that could cause personal injury or property damage.
- Do not attempt to carry passengers or heavy objects. This bike can only hold the weight of one person at a time. Do not exceed the weight limit.
- Ride e-bikes only where permitted. You must obey local laws and be courteous to pedestrians.



Battery Maintenance

A well-maintained battery performs well even after high mileage. Charge the battery after each ride to prevent the battery from draining from a full charge. Batteries perform best when used at room temperature (70°F [22°C]). However, Using it at temperatures below 32°F (0°C) will degrade performance. In general, at -4°F (-20°C), Battery performance drops to half of that at 70°F (22°C). When the temperature rises, battery life will resume.

Refer to local laws and regulations regarding battery recycling and/or disposal.

Under normal circumstances, A fully charged battery can hold power for 90 days in standby mode. Remember to charge the battery after each use. Draining the battery may cause permanent damage to the battery. Electronics inside the battery record the charge and discharge of the battery. Damages due to over-discharge or over-discharge are not covered by the warranty.

Notice

- Do not perform any maintenance while the e-bike is powered on or charged.
- Do not store or charge the battery within the temperature range of 20°C-25°C / 68°F-77°F. Do not pierce the battery.
- Do not attempt to disassemble the battery to avoid fire.
- When the ambient temperature exceeds the maximum operating temperature (See instruction manual), Do not ride it electric bike.
- Temperature will limit maximum power/torque. Otherwise, Personal injury or property damage may occur. Before cleaning, make sure the power is turned off and the charging cable is unplugged. Otherwise, You may damage electronic components. Proper cleaning of your e-bike can guarantee a longer lifespan and a smoother ride.
- Wipe the outer body of the e-bike with a soft and dry microfiber cloth.
- Check around the wheel to make sure there are no foreign objects. The design of this electric bike makes wheel maintenance easy.
- The E-Bike has IPX4 water resistance, Which means it can withstand splashes. However, Don't submerge the E-Bike in water.

Note

- Do not use alcohol, Gasoline, Acetone, Or other corrosive/volatile solvents to clean the bike. These substances can damage the exterior and the internal structure of the bike.
- Do not allow water and liquids to enter the electric parts or battery of the e-bike.



The bike should be fully charged before storage to prevent the battery from being over-discharged after long-term storage.

If the electric bike is to be stored for more than a month, Discharge and charge the battery at least once a month.

Notice

Do not store the electric bike outdoors for extended periods of time. Exposure to sunlight and extreme temperatures (Both hot and cold) Accelerates the aging process of plastic parts and can reduce battery life.

Store in a cool dry place.

Do not store in dusty environments as damage may occur over time. Cover the bike to prevent dust from entering.



- This product cannot be disposed of by incineration, Landfilling or mixing with household waste. Improper handling of the battery in this product may cause the battery to heat, Rupture, Or ignite, which could result in serious injury. The substances inside the battery pose a chemical risk to the environment. The end-of-life disposal recommendation for any CYCROWN product is to dispose of the entire device at an e-waste recycling center or through an e-waste recycling center, Project or facility.
- Local regulations and laws related to the recycling and disposal of lithium-ion batteries and/or products containing lithium-ion batteries vary by national, State, And local government. In order to properly dispose of batteries and/or products containing batteries, You must check the laws and regulations that correspond to where you live.
- It is the user's responsibility to properly dispose of waste equipment in accordance with local regulations and laws. For additional information on disposing of batteries and electronics or electronic waste, Please contact your local waste management office or household waste disposal service.



Specification

Item	Meaning
Model Name	CycFree
Net Weight	82.5 LB / 37.4 KG
Product Dimensions	68.1*24.4*53.1 IN / 1730*620*1350 MM
Package Dimensions	57*11*29.5 IN / 1450*280*750 MM
Max. Incline	11° (Rider Weighs 220.4 LBS / 100 KG)
Max. Capacity	330 LBS / 150 KG
Max. Speed	20 MPH / 32 KM/H
Range	80-100 KM / 50-62 Miles
Motor	500W
Battery Voltage	48 V 20Ah
Charge Voltage	100-240V/3A
Wheel Size	20 IN
Charge Time	7 Hours
Water Resistance	IPX4
Storage Temperature	20°C-25°C / 68°F-77°F
Operating Temperature	-4°F-140°F / -20°C~60°C
Charging Temperature	32°F-104°F / 0°C-40°C
Warranty	1 Year Limited



Warranty

Dear Customer

Thank you for purchasing our foldable lithium battery bicycle! After purchasing our products, please provide correct, Complete, And true personal information and fill in the warranty card to ensure that you receive high-quality service. For products that meet the warranty conditions, Free maintenance is provided. We make the following commitments:

1. You can receive warranty service with the warranty card. The serial number on the bike body must match the serial number on the warranty card. If you can't provide proof of the repair date, Then the factory date or the order date will be the start date of the warranty and we will confirm if it is still within the repair date.
2. From the date of sale to the warranty expiration day, If there is a performance failure caused by non-human damage, once confirmed, Our company promises to repair it free of charge. If the performance failure caused by man-made damage, Once confirmed, Our company will carry out paid maintenance.

Warranty Disclaimer

The following situations are not covered by the warranty service, And you need to pay the relevant service fees. Beware:

1. Total riding distance is over 100 Kilometers.
2. Any damage caused by not following the instructions for use of the electric bike.
3. Lost or changed electric bike number.
4. Product damage caused by accidental factors or improper use, Such as mechanical damage, Breakage, and serious impact on the product, Oxidation, etc.
5. Overload, over obstacles (Including but not limited to bottom pedals, Falls, Etc.), Or damage caused by extreme conditions.
6. Any damage caused by abnormal storage conditions or electrical resistance, Such as fire, Immersion, High temperature, And earthquake.
7. Loss of wearing parts, Such as packaging materials and various technical materials.
8. Other failures or damages not caused by product design, Technology, Manufacturing, Quality, Or other issues.
9. Not purchased from the CYCROWN online store.



Contact Us

If you have issues with riding, Maintenance and safety, Or faults/failures with the CYCROWN CycFree electric bike, Please contact us.

✉ E-mail Service: support@cycrown.com

🌐 www.cycrown.com