

# LOREX®

4K IP Smart Deterrence Bullet Security Camera

E892AB Series  
English Version 2.0



Quick Start Guide  
lorex.com

## Package Contents

- 4K IP Smart Deterrence Bullet Security Camera
  - Mounting Kit\*
  - Ethernet Extension Cable with Pre-attached RJ45 Cable Gland\*
- \* Per camera in multi-camera packs.

**ATTENTION:**

It is recommended to connect the camera to the NVR or an external PoE switch. If using a DC power adapter (not included) with the camera, a REGULATED power supply is REQUIRED for use with this camera. Use of a non-regulated, non-conforming power supply can damage this product and voids the warranty.

## Dimensions

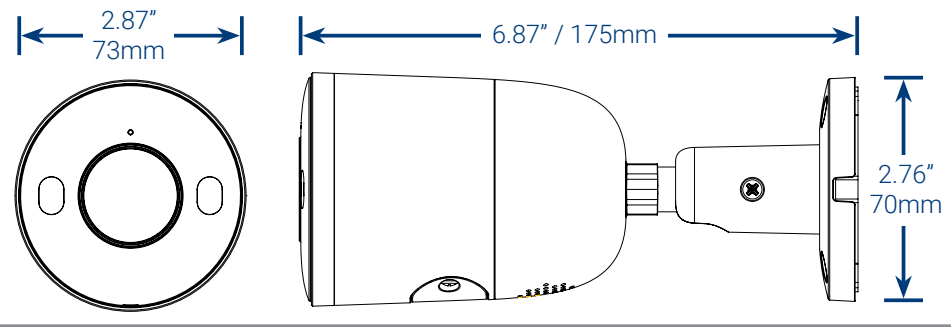

## Safety Precautions

- Use the camera only with compatible Lorex NVRs.
- Read this guide carefully and keep it for future reference.
- Follow all instructions for safe use of the product and handle with care.
- Use the camera within given temperature, humidity and voltage levels noted in the camera's specifications.
- Do not disassemble the camera.
- Do not point the camera directly towards the sun or a source of intense light.
- Use only a regulated power supply with the product (optional). Use of a non-regulated, non-conforming power supply can damage the product and void the warranty.
- Periodic cleaning may be required. Use a damp cloth only. Do not use any harsh, chemical-based cleaners.
- Check the packaging of the included cable to verify cable grade based on model number. **CBL605U:** The supplied cable is rated for surface and in-wall mounting. **CBL100C5:** The supplied cable is rated for surface mounting only. Cables for in-wall and floor-to-floor installations are sold separately (CMR type). These and other cables are available at [lorex.com](http://lorex.com).

## Disclaimers

- For a full list of compatible recorders, visit [lorex.com/compatibility](http://lorex.com/compatibility).
- To ensure that you are viewing camera video in full 4K resolution (4K monitor required), check the video output resolution of your recorder. For full instructions, see your recorder's documentation at [lorex.com](http://lorex.com).
- Not intended for submersion in water. Installation in a sheltered location recommended.
- This camera includes an Auto Mechanical IR Cut Filter. When the camera changes between Day/Night viewing modes, an audible clicking noise may be heard from the camera. This clicking is normal, and indicates that the camera filter is working.

## Need Help?

Visit us online for up-to-date software and complete instruction manuals

- 1 Visit [lorex.com](http://lorex.com)
- 2 Search for the model number of your product
- 3 Click on your product in the search results
- 4 Click on the **Downloads** tab

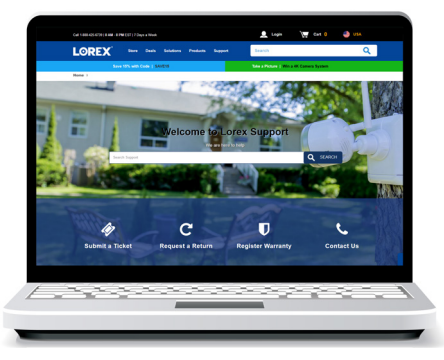

Copyright © 2020 Lorex Corporation  
As our products are subject to continuous improvement, Lorex reserves the right to modify product design, specifications and prices, without notice and without incurring any obligation. E&OE. All rights reserved.

## STEP 1: Important Installation Guidelines

The optimal installation location including height/angle for your camera will depend on the type of detection settings that you want to enable. The optimal angle for person and vehicle detection is different from the optimal angle for face detection. Based on your detection preference choose between Step 1A or 1B.

### 1A. Optimizing Person and Vehicle Detection Accuracy:

- Angle the camera so that objects of interest appear in the bottom 2/3 of the camera image.
- Choose a location where objects of interest will be no further than 50ft (~15m) from the camera.



Lower accuracy for objects further away than 50ft (~15m) and/or in the top 1/3 of the image.

Optimal accuracy for objects within 50ft (~15m) and in the bottom 2/3 of the image.

- Angle the camera between 30~60° down from the level position.
- Install the camera between 8-16ft (2.5-5m) off of the ground.

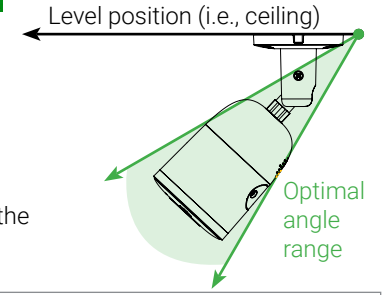

**NOTE:** Accuracy of person and vehicle detection will be influenced by multiple factors, such as the object's distance from the camera, the size of the object, and the height and angle of the camera. Night vision will also impact the accuracy of detection.

### Additional Installation Tips:

- Point the camera where there is the least amount of obstructions (e.g., tree branches).
- Install the camera where vandals cannot easily reach.
- Secure cabling so that it is not exposed or easily cut.
- This camera is rated for outdoor use. Installation in a sheltered location is recommended.

### 1B. Optimizing Face Detection Accuracy:

- The camera should be installed about 10 feet above the ground so as to ensure that the full proportion of the face is detected on the screen.
- Angle the camera approximately 15° down from the level position.
- To distinguish facial features the distance from the camera to the face should be approximately 15 feet.

### High Accuracy Face Detection Vs. Low Accuracy Face Detection



Accuracy of Face Detection will be influenced by the distance and angle of the face from the camera. For optimal Face Detection the camera must be positioned head on to capture a person's entire face looking straight ahead. Obscured and/or partially or fully covered faces (i.e. a person's head tilted down to look at their phone) will not be accurately detected. During low light conditions the camera will impact color night vision by switching to black & white to ensure accuracy and improve detection range of Face Detection. If you cannot meet the above requirements for installation it may be best to use person detection instead.

**IMPORTANT:**

- Face Detection is only available up to two channels. You cannot enable both Face Detection and Person and Vehicle Detection at the same time.
- Face Detection is compatible with certain Lorex NVR's only. For a list of compatible NVR's please visit [lorex.com/compatibility](http://lorex.com/compatibility).
- Face Detection is disabled by default. For more information on Face Detection setup and configuration, refer to the NVR's manual at [lorex.com](http://lorex.com).

## STEP 2: Installing the Camera

**ATTENTION:**

- Test your camera prior to selecting a permanent mounting location by temporarily connecting the camera and cable to your NVR.
- Review the section "STEP 1: Important Installation Guidelines" above before choosing a permanent mounting location.

### Before Installing the Camera

- Decide whether to run the cables through the wall / ceiling (drilling required) or along the wall / ceiling.
- If you run the cables along the wall / ceiling, you must run the cable through the **cable notch** on the base. This will keep the camera base flush to the surface when mounted.

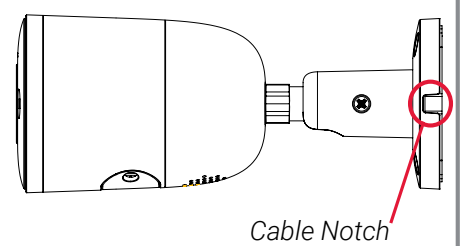

### To install your camera:

1. Use the included mounting template to mark holes for the screws.
2. Drill holes for the mounting screws.  
**NOTE:** Insert the included drywall anchors if you are installing the camera in drywall.
3. Connect cables as shown in the section "Connecting the Camera".
4. Feed the cable through the mounting surface or cable notch and mount the camera stand to the surface using the provided screws.
5. Use a Philips head screwdriver (not included) to loosen the adjustment screw shown below. Adjust the camera position as needed:

- Tilt the camera on the stand up to 90°.
- Twist the camera around the stand 360°.

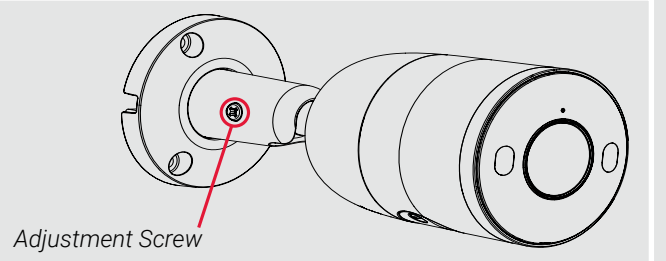

6. Tighten the adjustment screw to secure the position.
7. Remove the vinyl film from the camera lens when your installation is complete.

## Connecting the Camera

*Ethernet Cable*

**Camera**

Connect the Ethernet cable to the camera.

**NOTE:** A 12V DC power adapter (model#: **ACCPWR12V1**, not included) is only required if connecting the camera's Ethernet cable to a router or switch that does not support PoE.

**NVR**

Connect the other end of the Ethernet cable to the NVR's PoE ports. The camera may take a minute to power up after being connected.

**OR**

Connect the other end of the Ethernet cable to a router or switch on your network. See your NVR manual for details on connecting the camera to your NVR using a switch or router.

## Using the RJ45 Cable Gland (Optional)

The pre-attached RJ45 cable gland covers the camera's Ethernet connector and the RJ45 plug to provide weather-resistance and protection from dust, dirt and other environmental contaminants.

### To use the RJ45 cable gland:

Twist the RJ45 cable gland barrel securely onto the camera Ethernet connector.

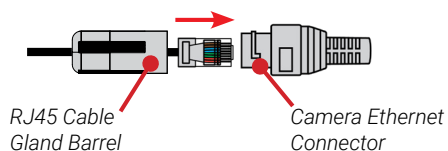

**NOTE:** The RJ45 cable gland is weather-resistant. Seal the cap with silicone and/or electrical tape for additional sealing if it will be exposed to precipitation regularly.

## Setup Diagram

### Scenario 1: Connect Cameras to NVR

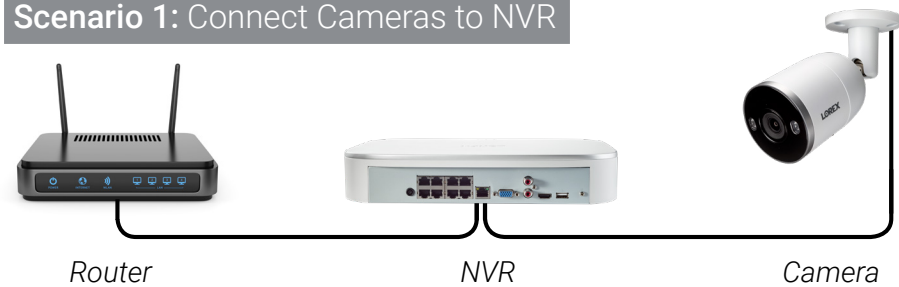

### Scenario 2: Connect Cameras to Local Area Network (LAN)

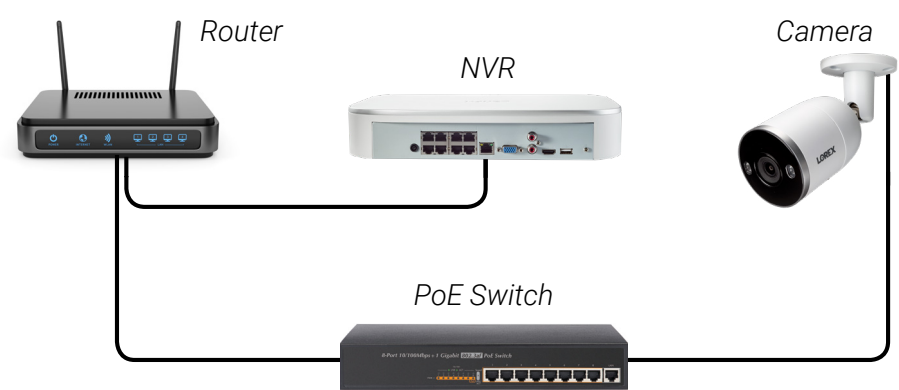

### ATTENTION:

- This camera is only compatible with select NVRs. For a list of compatible recorders, visit [lorex.com/compatibility](http://lorex.com/compatibility).
- You must connect the camera to a supporting H.265 NVR to take advantage of H.265 compression. For instructions on enabling H.265 compression, visit [lorex.com](http://lorex.com), and search for "How do I enable H.265 compression?".

## Cable Extension Options

Extend the Ethernet cable run for your camera up to 300ft (91m). See table below. It is recommended to use UL CMR approved cables available at [lorex.com](http://lorex.com).

Cable Type	Max Cable Run Distance	Max # of Extensions
CAT5e (or higher) Ethernet cable	300ft (91m)	3

- You can use a RJ45 coupler or network switch (not included) to connect male ends of Ethernet cable together.
- To extend the cable run beyond 300ft (91m), a switch will be required (sold separately).

## Audio Settings

### ATTENTION:

**Audio recording and listen-in audio are disabled by default.** Audio recording and/or use of listen-in audio without consent is illegal in certain jurisdictions. Lorex Corporation assumes no liability for use of its products that does not conform with local laws.

### To enable audio recording and listen-in audio:

- From Live View, right-click and click **Main Menu**. Enter the system user name (default: **admin**) and password.
- Click **Camera** and select **Recording**.
- Under **Channel**, select the channel where the audio-capable camera is connected.
- Under **Main Stream**, click the **More Setting** button.
- In the **More Setting** window:
  - Enable **Audio Encode** for audio recording and listen-in audio. **NOTE:** Listen-in audio requires a monitor with speakers or speakers connected to the NVR.
  - Select the format that will be used to record audio. **ACC** is recommended.
- Click **OK** to save changes.

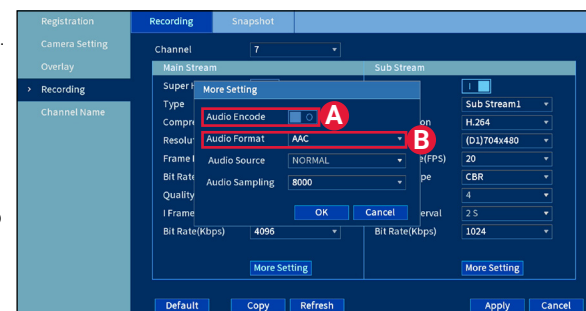

**NOTE:** These instructions are based on current NVR interface. For the most up-to-date instructions, see your NVR's instruction manual on [lorex.com](http://lorex.com).

## Using Deterrence Features

Use your Lorex app to manually activate the camera's white light and siren features when connected to a compatible Lorex recorder.

**PREREQUISITE:** Connect to your Lorex system using the app specified in your recorder documentation.

### To activate deterrence features manually:

- Launch the app and tap your recorder to view connected channels.
- Tap a connected deterrence camera to open it in single-channel view.
- Tap to activate the white light, or tap to activate the siren.

**NOTE:** You can also set schedules and active areas of the camera image where the white light will be triggered automatically when motion is detected. For full instructions, refer to the app manual on your product page at [lorex.com](http://lorex.com).

## Troubleshooting

Problem	Solution
No picture / signal	<ul style="list-style-type: none"> <li>Ensure the camera is connected to a compatible NVR. For full compatibility, visit <a href="http://lorex.com/compatibility">lorex.com/compatibility</a>.</li> <li>The camera may take up to 1 minute to power up after being connected to the NVR. Wait two minutes before following the steps below.</li> <li>Ensure the camera is connected to your NVR or to your local network.</li> <li>If you are not using PoE, you must connect the camera to a 12V DC power adapter (not included).</li> <li>If the camera is connected to the LAN, you must search your network for cameras using the NVR. See the NVR's instruction manual.</li> <li>Ensure your NVR is properly connected to a monitor.</li> <li>There may be an issue with your extension cable run. Connect the camera to the NVR using a different Ethernet cable.</li> </ul>
Picture does not appear to be 4K	<ul style="list-style-type: none"> <li>To ensure that you are viewing camera video in full 4K resolution (4K monitor required), check the video output resolution of your NVR. For full instructions, see your NVR's documentation at <a href="http://lorex.com">lorex.com</a>.</li> </ul>
Picture is too bright	<ul style="list-style-type: none"> <li>Ensure your camera isn't pointed directly at a source of light (e.g., sun or spot light).</li> <li>Move your camera to a different location.</li> <li>Check the brightness and contrast settings on the NVR.</li> </ul>
Picture is too dark	<ul style="list-style-type: none"> <li>Check the brightness and contrast settings on the NVR.</li> </ul>
Night vision is not working	<ul style="list-style-type: none"> <li>The night vision activates when light levels drop. The area may have too much light.</li> </ul>
Picture is not clear	<ul style="list-style-type: none"> <li>Check the camera lens for dirt, dust, spiderwebs. Clean the lens with a soft, clean cloth.</li> <li>Make sure that the cable run is within the limitations specified in the section 'Cable Extension Options'.</li> <li>Remove the vinyl film from the camera lens when your installation is complete.</li> </ul>
Bright spot in video when viewing camera at night	<ul style="list-style-type: none"> <li>Night vision reflects when pointing a camera through a window. Move the camera to a different location.</li> </ul>
Picture is in color in dark conditions	<ul style="list-style-type: none"> <li>This camera's image sensor is extra sensitive to light, meaning that the camera stays in color mode at low-light conditions. For instructions on how to make your camera switch to night mode, visit <a href="http://lorex.com">lorex.com</a>, and search for "How do I make my camera switch to night mode?".</li> </ul>
The camera warning light is not switching on automatically	<ul style="list-style-type: none"> <li>Ensure that you have enabled and configured white light deterrence using a compatible NVR. See your NVR's documentation for full instructions.</li> <li>Ensure the active areas and schedule for white light deterrence are set properly. The default schedule for the warning light is night times (between 5PM and 7AM).</li> </ul>
The camera siren is not switching on automatically	<ul style="list-style-type: none"> <li>The camera siren cannot switch on automatically. You can control the camera siren manually using a compatible Lorex NVR or app. Refer to your NVR's documentation for full instructions.</li> </ul>
No audio	<ul style="list-style-type: none"> <li>Audio is only supported on Lorex NVRs. For a list of compatible recorders, visit <a href="http://lorex.com/compatibility">lorex.com/compatibility</a>.</li> <li>Ensure NVR volume is turned on / turned up.</li> <li>Ensure audio function on camera is turned on (see 'Audio Settings').</li> <li>Ensure audio is turned up on viewing device.</li> </ul>
Two-way talk not working	<ul style="list-style-type: none"> <li>Use the Lorex app specified in your NVR documentation to activate two-way talk. Tap  from the camera's live view, then speak into the microphone on your mobile device. Tap again when finished speaking.</li> </ul>