

*If you have questions or comments, contact us.  
Pour toute question ou tout commentaire, nous contacter.  
Si tiene dudas o comentarios, contáctenos.*

**1 (877) 362 4271 • [www.dewaltpw.com](http://www.dewaltpw.com)**

**INSTRUCTION MANUAL  
GUIDE D'UTILISATION  
MANUAL DE INSTRUCCIONES**

INSTRUCTIVO DE OPERACIÓN, CENTROS DE SERVICIO Y PÓLIZA DE GARANTÍA. **ADVERTENCIA:** LÉASE ESTE INSTRUCTIVO ANTES DE USAR EL PRODUCTO.

---

# DEWALT®

---

**DXPW2000E, DXPW2500E, DXPW3000E  
Pressure Washer  
Laveuse à pression  
Lavadora a presión**

## Pressure Washer

- |                                |  |
|--------------------------------|--|
| A. Panel assembly              | G. Handle assembly                         |
| B. Nozzle holder               | H. High-pressure hose                      |
| C. Spray gun                   | I. High-pressure pump                      |
| D. Wheel                       | J. Motor                                   |
| E. Quick-connect<br>spray wand | K. ON/OFF Switch/Control Box               |
| F. Frame                       | L. Pressure Adjustment Knob<br>(not shown) |

## Pump

For best results, pump oil designed specifically for pressure washers is recommended, as these contain a rust inhibitor and an anti-foaming agent. If this oil is not available, an SAE 15W-40 oil may be used.

## Specifications

MODEL	DXPW2000E	DXPW2500E	DXPW3000E
Rated Pressure *	2000 psi	2500 psi	3000 psi
Rated Water Flow *	3.0 gpm	3.5 gpm	4.0 gpm
Max water temp	100 °F/38 °C		
Electrical Requirements	208/230V Single Phase		
Electrical Cord	35 ft. (10.6 m) with GFCI		
High Pressure Hose	50 ft. (15.24 m)		
Minimum Amp Source	19A	24A	32A
Pressure of Inlet Water	20–100 psi		
Inlet Water	cold tap (100 °F max)		
Soap Consumption Rate	10% max		
* Rated Pressure and Rated Water Flow is within manufacturing tolerance of (+/- 10%).			

FIG. 1

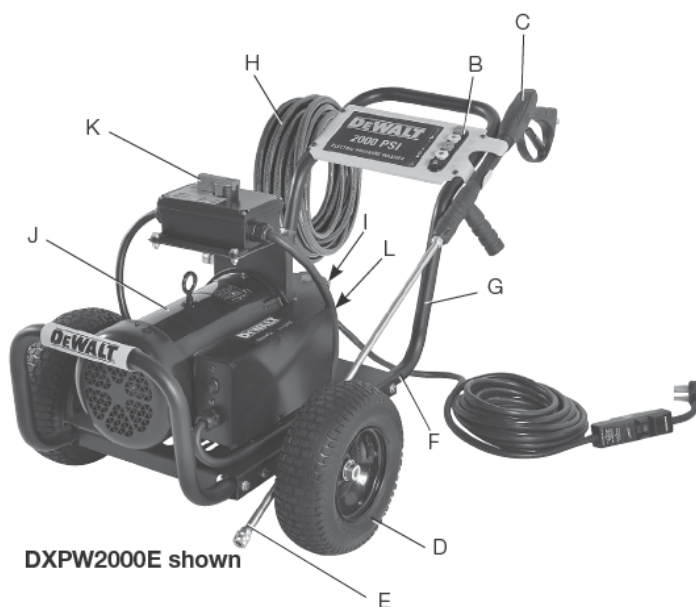

In a continued commitment to improve quality, the manufacturer reserves the right to make component changes, design changes, or specification changes when necessary and without notice.

### Definitions: Safety Guidelines

The definitions below describe the level of severity for each signal word. Please read the manual and pay attention to these symbols.

**▲DANGER:** Indicates an imminently hazardous situation which, if not avoided, **will** result in **death or serious injury**.

**▲WARNING:** Indicates a potentially hazardous situation which, if not avoided, **could** result in **death or serious injury**.

**▲CAUTION:** Indicates a potentially hazardous situation which, if not avoided, **may** result in **minor or moderate injury**.

**NOTICE:** Indicates a practice **not related to personal injury** which, if not avoided, **may** result in **property damage**.

IF YOU HAVE ANY QUESTIONS OR COMMENTS ABOUT THIS CONTACT US AT: [www.dewaltpw.com](http://www.dewaltpw.com) or 1 (877) 362 4271

**▲WARNING:** Please read this entire manual before attempting to assemble, operate or install the product.

**▲WARNING:** This unit was designed for specific applications. It should not be modified and/or used for any application other than that which it was designed.

**NOTICE:** Always store your pressure washer in a location where the temperature will not fall below 40 °F (4 °C). freeze damage is not covered by the warranty.

**▲WARNING:** This product contains chemicals known to the State of California to cause cancer, and birth defects or other reproductive harm. In addition, some cleaning products and dust contain chemicals know to the State of California to cause cancer, and birth defects or other reproductive harm. **Wash hands after handling.**

### READ AND SAVE THESE INSTRUCTIONS

### IMPORTANT SAFETY INSTRUCTIONS

**▲WARNING:** When using this product basic precautions should always be followed, including the following:

1. Read all the instructions before using the product.
2. To reduce the risk of injury, do not operate near children or animals.
3. Know how to stop the product and bleed pressures quickly. Be thoroughly familiar with the controls.
4. Stay alert - watch what you are doing.
5. Do not operate the product when fatigued or under the influence of alcohol or drugs.
6. Keep operating area clear of all persons.
7. Do not overreach or stand on unstable support. Keep good footing and balance at all times.
8. Follow the maintenance instructions specified in the manual.
9. This product is provided with a Ground Fault Circuit Interrupter built into the power cord plug. If replacement of the plug or cord is needed, use only identical replacement parts.
10. Do not touch plug or outlet with wet hands.
11. Avoid accidental starts. Move switch on unit to OFF position before connecting or disconnecting cord to electrical outlets.
12. Water spray must never be directed towards any electric wiring or directly towards the pressure washer machine itself or fatal electric shock may occur.
13. Never carry your pressure washer by the cord. Do not pull on the cord to disconnect from the outlet.
14. To prevent damage, the cord should not be crushed, placed next to sharp objects or near a heat source.
15. Check power cords before using. Damaged cords can reduce performance of pressure washer or cause a fatal electrical shock.

16. The narrow pin point stream is very powerful. It is not recommended for use on painted surfaces, wood surfaces or items attached with an adhesive backing.
  17. Keep operating area clear of all persons and animals.
  18. Always use both hands when operating pressure washer to maintain complete control of the wand.
  19. Do not touch nozzle or water spray while operating. Never place hands in front of nozzle.
  20. Wear safety goggles while operating. Wear protective clothing and footwear to protect against accidental spraying.
  21. Disconnect power plug from the outlet when not in use and prior to the detaching of the high pressure hose.
  22. Never tie knots or kink the high pressure hose as damage could result. Inspect the high-pressure hose regularly. Replace the hose immediately if it is damaged, worn or shows any signs of cracks, bubbles, pinholes, or other leakage. Never grasp a high-pressure hose that is leaking or damaged.
  23. Do not operate or store this product in temperatures below 40 °F (4 °C). Freeze damage is not covered by the warranty.
  24. Carefully observe all chemical instructions and warnings before using. Use only approved pressure washer cleaners. Do not use bleach, chlorine, or any cleaners containing acids. Always follow manufacturer's label recommendations for proper use of cleaners. Always protect eyes, skin and respiratory system from cleaners.
  25. The pressure washer should not be used in areas where gas vapors may be present. An electric spark could cause an explosion or fire.
  26. To minimize the amount of water getting into the pressure washer, the unit should be placed as far as possible from the cleaning site during operation.
  27. To prevent accidental discharge, the spray gun should be secured by locking the trigger when not in use.
  28. To allow free air circulation, the pressure washer should NOT be covered during operation.
  29. Never touch, grasp or attempt to cover a pinhole or similar water leak on the high-pressure hose. The stream of water IS under high pressure and WILL penetrate skin.
  30. Use only hoses and accessories rated for pressure higher than your pressure washer's psi. Never use with any other manufacturer's accessories or components.
  31. Never defeat the safety features of this product.
  32. Do not operate machine with missing, broken or unauthorized parts.
  33. Never spray flammable liquids or use pressure washer in areas containing combustible dust, liquid, or vapors.
  34. DO NOT use an extension cord with this pressure washer.
- ▲WARNING:** Risk of injection or injury. Do not direct discharge stream at persons.

### **SAVE THESE INSTRUCTIONS FOR FUTURE USE**

#### **MOTOR OVERLOAD**

The electric motor in this pressure washer is equipped with an overload protection device which will automatically shut off the motor in the event the motor draws excessive current or overheats. Allow motor to cool and then reset thermal overload button on pump motor.

#### **GROUNDING INSTRUCTIONS**

This product must be grounded. If it should malfunction or breakdown, grounding provides a path of least resistance for electric current to reduce the risk of electric shock. This product is equipped with a cord having an equipment-grounding conductor and a grounding plug. The

plug must be plugged into an appropriate outlet that is properly installed and grounded in accordance with all local codes and ordinances.

**▲WARNING:** *Improper connection of the equipment-grounding conductor can result in a risk of electrocution. Check with a qualified electrician or service person if you are in doubt as to whether the outlet is properly grounded. Do not modify the plug provided with the product if it will not fit the outlet installed by a qualified electrician. Do not use any type of adaptor with this product.*

#### GROUND-FAULT CIRCUIT INTERRUPTER PROTECTION

This pressure washer is provided with a Ground-Fault Circuit-Interrupter (GFCI) built into the power supply cord. This device provides additional protection from the risk of electric shock. Should replacement of the plug or cord become necessary, use only identical replacement parts that include GFCI protection.

### Power Supply And Electrical Info

#### GROUND-FAULT CIRCUIT INTERRUPTER PROTECTION

The pressure washer is factory-equipped with an electrical cord equipped with a Ground Fault Circuit Interrupter (GFCI). This cord should only be connected to an electrical outlet installed in accordance with local safety regulations.

**NOTE:** The power supply must be 208/230V Single Phase, 60 Hz and a minimum of 19 amps for DXPW2000E, 24 amps for DXPW2500E or 32 amps for DXPW3000E on a dedicated circuit.

- A. Inspect cord before using. Do not use if cord is damaged.
- B. Keep all connections dry and off the ground.
- C. Do not touch plug with wet hands.
- D. The pressure washer is provided with a ground fault circuit interrupter built into the power plug.

If replacement of the plug or cord is needed, use only identical replacement parts. Contact customer service for proper replacement parts.

**▲WARNING:** *Test GFCI before each use. DO NOT use pressure washer if test below fails.*

#### GFCI Test Procedures:

1. Plug power cord into power receptacle. Indicator light should illuminate.
2. Press test button (N). Light should turn off.
3. Press reset button (M) for use. Indicator light should illuminate.

Do not use if above test fails.

**NOTE:** The GFCI must be reset each time the pressure washer is connected to an electrical outlet. Reset by simply pushing the reset button on the GFCI.

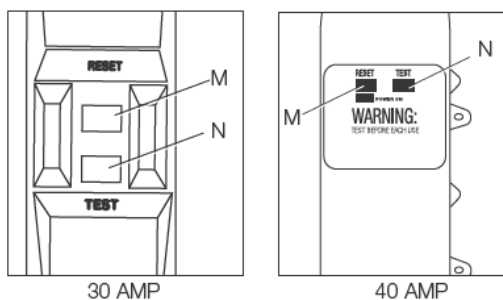

**SAVE THESE INSTRUCTIONS  
FOR FUTURE USE**

## INSTALLATION

### Pressure Washer Assembly (Fig. 1)

1. Attach high-pressure hose (H) to spray gun (C). Make sure it is secure.
2. Connect wand (E) to spray gun (C). Make sure connection is secure.

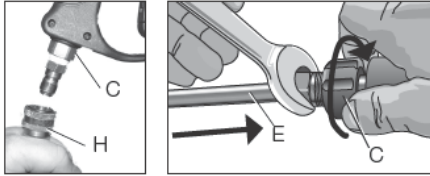

3. Place the nozzle holder (B) onto the panel assembly (A) and push each nozzle holder into place.
4. Remove the five colored quick-connect nozzles from the plastic bag and insert them into correct grommet on the nozzle holder. Nozzles are color coded to match colored nozzles on panel assembly.



**NOTE:** The high-pressure pump was filled with oil at the factory. Always check oil level before using (refer to **Maintenance** for more information).

**▲WARNING:** Risk of bursting. Use a tire pressure gauge to check the tires pressure before each use and while inflating tires; see the tire sidewall for the correct tire pressure.

**NOTE:** Air tanks, compressors and similar equipment used to inflate tires can fill small tires similar to these very rapidly. Adjust pressure regulator on air supply to no more than the rating of the tire pressure. Add air in small increments and frequently use the tire gauge to prevent over inflation.

## OPERATION

### Pressure Adjustments (Fig. 1)





The pressure setting is preset at the factory to achieve optimum pressure and cleaning. To lower the pressure, follow these instructions.

1. Back away from the surface to be cleaned. The further away you are, the less the pressure will be on the surface to be cleaned.
2. Change to the 40° nozzle (white). This nozzle delivers a less powerful stream of water and a wider spray pattern. Refer to **Spray Wand Nozzles**.
3. Water pressure can be varied by turning the pressure adjusting knob (L) clockwise to increase pressure and counterclockwise to decrease pressure.

**NOTICE:** DO NOT attempt to increase pump pressure. A higher pressure setting than the factory set pressure may damage pump.

### Spray Wand Nozzles (Fig. 1)

The nozzles for the spray wand are stored in the nozzle holder (B) on the panel assembly (A). Colors on the panel identify nozzle location and spray pattern. Refer to the following chart to choose the correct nozzle for the job to be performed.

Nozzle Color	Spray Pattern	Uses	Surfaces*
Red	0° 	powerful pinpoint for spot cleaning of hard, unpainted surfaces or for high reach areas	unpainted metal or concrete; DO NOT use on wood
Yellow	15° 	intense cleaning of unpainted hard surfaces	grills, driveways, concrete or brick walkways, unpainted brick or stucco
Green	25° 	standard cleaning nozzle for most applications	yard tools, sidewalks, lawn furniture, unpainted siding, stucco, gutters and eaves, concrete, brick surfaces
White	40° 	cleaning of painted or delicate surfaces	auto/RV, marine, wood, painted brick and stucco, vinyl, painted siding
Black	low pressure 	applies cleaning solutions	low pressure spray is safe on all surfaces. always verify compatibility of cleaning solution prior to use

\* **NOTICE:** The high-pressure spray from your pressure washer is capable of causing damage to surfaces such as wood, glass, automobile paint, auto striping and trim, delicate objects such as flowers and shrubs. Before spraying, check the item to be cleaned to assure yourself that it is strong enough to resist damage from the force of spray.

#### CHANGING NOZZLES ON SPRAY WAND

**⚠ DANGER:** Risk of fluid injection. Do not direct discharge stream toward persons, unprotected skin, eyes or any pets or animals. Serious injury will occur.

**⚠ WARNING:** Flying objects could cause risk of serious injury. DO NOT attempt to change nozzles while pressure washer is running. Turn engine off before changing nozzles.

1. Pull quick-connect coupler back and insert nozzle.
2. Release quick-connect coupler and twist nozzle to make sure it is secure in coupler.

**⚠ WARNING:** Flying object could cause risk of serious injury. Ensure nozzle is completely inserted in quick-connect socket and quick-connect collar is fully engaged (forward) before squeezing gun trigger.

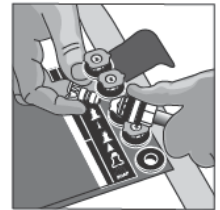

#### Chemicals and Cleaning Solvents

Applying chemicals or cleaning solvents is a low-pressure operation.

**NOTE:** Use only soaps and chemicals designed for pressure washer use. **Do not use bleach.**

### TO APPLY CHEMICALS AND SOLVENTS

1. Press chemical hose (S) onto barbed fitting located near high pressure hose connection of pump as shown.
2. Place the other end of chemical hose with filter on it into the container holding chemical/cleaning solution.

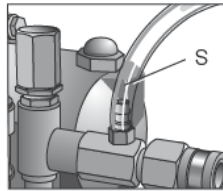

**NOTE:** For every 10 gallons (38 liters) of water pumped 1 gallon (3.8 liters) of chemical/cleaning solution will be used.

3. Install low-pressure (black) nozzle into quick connect fitting of spray wand, refer to **Spray Wand Nozzles**. **NOTE:** Chemicals and soaps will not siphon if the black soap nozzle is not installed on the spray wand.

**NOTE:** There is a detergent adjustment knob located on the pump head. Turn the adjustment knob counterclockwise to set the detergent adjustment to the MAX setting. Turn the adjustment knob clockwise to adjust the detergent.

4. After use of chemicals, place chemical hose into container of clean water and draw clean water through chemical injection system to rinse system thoroughly. If chemicals remain in the pump it could be damaged. Pumps damaged due to chemicals will not be covered under warranty.

### CLEANING TECHNIQUES

When cleaning with the pressure washer, some cleaning tasks can be solved with water alone, but for most tasks it is advantageous to use a detergent. A detergent ensures a quick soaking of the dirt allowing the high pressure water to penetrate and remove the dirt more effectively.

### APPLICATION OF DETERGENT

**CAUTION:** Avoid working on hot surfaces or in direct sunlight to minimize the chance of the soap damaging painted surfaces.

**CAUTION:** Damage may occur to painted surface if soap is allowed to dry on the surface. Wash and rinse a small section at a time.

1. Apply the solution to a DRY work surface.

**NOTE:** Wetting the surface first is not recommended, as it dilutes the detergent and reduces its cleaning ability.

On a vertical surface, apply soap horizontally from side to side starting from the bottom to avoid streaking.

2. Allow detergent to remain on the surface for a short time before rinsing.
3. Rinse with clean water under high pressure. On a vertical surface, first rinse from the bottom up, then rinse from the top down. Hold nozzle 6–8 in. (15–20 cm) from the work surface at a 45° angle using the flat spray as a peeling tool rather than a scrub brush.

**NOTE:** Ensure that the detergent injection system is completely clean prior to switching from one detergent to another.

### Starting

**WARNING:** To reduce the risk of injury, read the pressure washer instruction manual before starting pressure washer.

**DANGER:** Risk of fluid injection and laceration. When using the high-pressure setting, DO NOT allow the high-pressure spray to come in contact with unprotected skin, eyes, or with any pets or animals. Serious injury will occur.

- Your washer operates at fluid pressures and velocities high enough to penetrate human and animal flesh, which could result in amputation or other serious injury. Leaks caused by loose fittings or worn or damaged hoses can result in injection injuries. DO NOT TREAT FLUID INJECTION AS A SIMPLE CUT! See a physician immediately!

**NOTICE:** NEVER pull water supply hose to move pressure washer. This could damage hose and/or pump inlet.

- DO NOT use hot water, use cold water only.



- NEVER turn water supply off while pressure washer engine is running or damage to pump will result.
- DO NOT stop spraying water for more than two minutes at a time. Pump operates in bypass mode when spray gun trigger is not pressed. When the temperature inside the pump rises too high the thermal relief valve (T) will open and release a gush of water in an effort to lower the temperature inside the pump. The thermal relief valve will then close. If pump is left in bypass mode for more than two minutes internal components of the pump can be damaged.

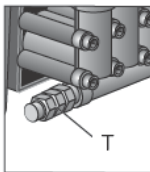

**⚠WARNING:** Do not allow the unit to run for more than two minutes without the gun trigger being pulled. This could cause overheating and damage to the pump. When the temperature inside the pump rises too high, the thermal relief valve will open and release a spray of water from the pump to lower the internal temperature. The valve will then close.

#### START-UP PROCEDURE

1. Connect the water hose to the water source. Turn the water source on to remove all air from the hose. When a steady stream of water is present, turn the water source off.
2. Verify the filter screen (U) is in water inlet of pump. Convex side faces out.

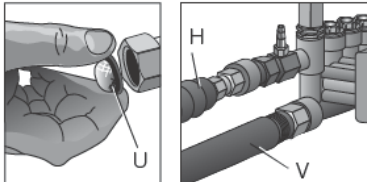

3. Connect the cold water source (V) to pump inlet.

**NOTE:** Water source must provide a minimum of 5 gallons per minute at 20 psi (138 kPa).

**⚠WARNING:** To reduce the possibility of contamination always protect against backflow when connected to a potable water system.

4. Connect high-pressure hose (H) to pump outlet.
5. If applying a chemical or cleaning solution, refer to **Chemicals and Cleaning Solvents**.
6. Turn the water source on.

**NOTICE:** Risk of property damage. Failure to do so could cause damage to the pump.

7. Remove all air from the pump and high pressure hose by depressing trigger until a steady stream of water is present.
8. Plug power cord into power receptacle. Firmly press and release the TEST button (N), then press and release the RESET button (M). The light on the GFCI should be illuminated.

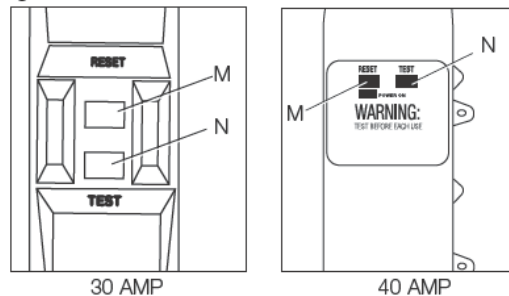

9. Place the motor ON/OFF switch (K) to the ON Position.

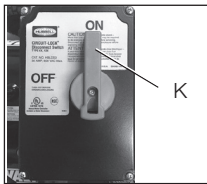

DXPW2000E  
DXPW2500E

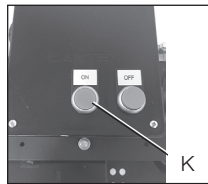

DXPW3000E

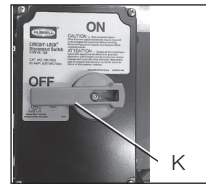

DXPW2000E  
DXPW2500E

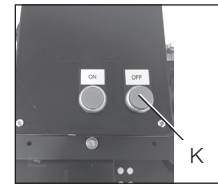

DXPW3000E

10. Depress trigger on gun to start water flow.

**▲WARNING:** Risk of unsafe operation. Stand on a stable surface and grip gun/wand firmly with both hands. Expect the gun to kickback when triggered.

11. Release trigger to stop water flow.

**▲DANGER:** Risk of injury from spray. Engage the trigger lock (X) when gun is not in use to prevent accidental spraying.

12. Adjust spray for the task being performed by changing quick connect nozzle. Refer to **Spray Wand Nozzles**.

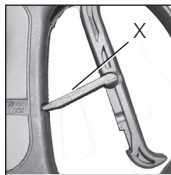

### Shutting Down

1. If chemicals were applied, place the chemical hose into a container of clean water and draw clean water through chemical injection system to rinse system thoroughly.

**NOTICE:** Risk of property damage Failure to do so could cause damage to the pump.

2. Place the motor ON/OFF switch (K) to the OFF Position.

**NOTICE:** Risk of property damage. NEVER turn water supply off while pressure washer is running or damage to pump will result.

3. Turn water source off.

4. Pull trigger on spray gun to relieve any water pressure in hose or spray gun.

5. Remove both the garden hose and high pressure hose from the unit.

6. Disconnect the wand from the gun.

7. Turn ON the machine and allow it to run for 5 seconds. (This will clear out most of the water trapped in the pump).

8. Unplug machine .

9. Refer to **Storage** for proper storage procedures.

### MAINTENANCE

**▲WARNING:** Risk of burning. When performing maintenance, you may be exposed to hot surfaces, water pressure or moving parts that can cause serious injury or death.

To ensure efficient operation and longer life of your pressure washer, a routine maintenance schedule should be prepared and followed. If the pressure washer is used in unusual conditions, such as high temperatures or dusty conditions, more frequent maintenance checks will be required.

## Pump

**NOTE:** The Pump was filled with oil at the factory. The preferred oil is SIMPSON® Premium Pump Crankcase Oil. If this oil is not available, an SAE 15W-40 oil may be used. Change the pump oil after the first 50 hours of operation and every 100 hours thereafter, or every 3 months.

### TO CHECK OIL

The oil level should come to the dot in the middle of the sight glass (AA).

### HOW TO CHANGE PUMP OIL

1. Loosen pump oil fill plug (BB).
2. Place a container under the oil drain plug (CC).
3. Remove pump oil drain plug.
4. After oil is drained, replace oil drain plug. Tighten securely.
5. Refill pump using SIMPSON® Premium Pump Crankcase Oil. If this oil is not available, an SAE 15W-40 oil may be used.
6. Replace pump oil plug and tighten securely.

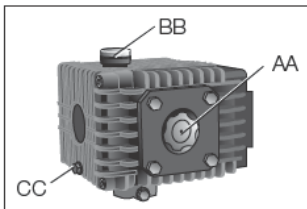

### Nozzle Cleaning

If the nozzle becomes clogged with foreign materials, such as dirt, excessive pressure may develop. If the nozzle becomes partially clogged or restricted, the pump pressure will pulsate. Clean the nozzle immediately using the nozzle kit supplied and the following instructions:

1. Shut off the pressure washer and turn off the water supply.
2. Pull trigger on gun handle to relieve any water pressure.
3. Disconnect the spray wand from the gun.

4. Remove the high-pressure nozzle from the spray wand. Remove any obstructions with the nozzle cleaning tool (Y) provided and back flush with clean water.

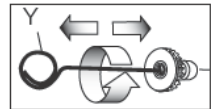

5. Direct water supply into spray nozzle to back flush loosened particles for 30 seconds.
6. Reassemble the nozzle to the wand.
7. Reconnect spray wand to gun then turn on water supply.
8. Start pressure washer and place spray wand into high pressure setting to test.

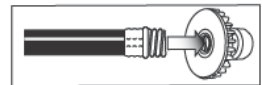

### To Clean the Water Inlet Filter

This filter screen (U) should be checked periodically and cleaned if necessary.

1. Remove the filter screen (U) by grasping the end and removing it from water inlet of pump.
2. Clean filter by flushing it with water on both sides.
3. Reinsert filter into water inlet of pump. Convex side faces out.

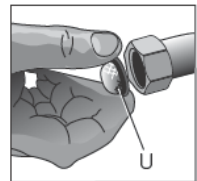

**NOTE:** Do not operate pressure washer without filter properly installed.

## STORAGE

### Pump

The manufacturer recommends using SIMPSON®/POWERWASHER™ Pump Guard or equivalent when storing the unit for more than 30 days and/or when freezing temperatures are expected. SIMPSON®/POWERWASHER™ Pump Guard is environmentally friendly.

**NOTE:** Using pump guard helps provide proper lubrication to the internal seals of the pump regardless of temperature or environment.

**NOTICE:** Risk of property damage. Use only SIMPSON® / POWERWASHER™ Pump Guard or equivalent. Other products could be corrosive and/or contain alcohol which may cause pump damage.

1. Turn off pressure washer and disconnect hoses from pump.
2. Unscrew bottle valve from Pump Guard bottle and remove seal.
3. Screw bottle valve back onto bottle.
4. Attach bottle to water inlet of pump.
5. Squeeze bottle to inject contents into pump.
6. With ignition switch off, simultaneously pull starter rope and squeeze bottle. Repeat until protector fluid exits pump outlet.

**NOTE:** This step may require two people.

### Pressure Washer

1. Drain all water from high-pressure hose, coil it and store it in cradle of the pressure washer handle.
2. With nozzle pointed down and the spray gun and wand in a vertical position, squeeze trigger to drain all water from spray gun and wand. Store in gun holder.
3. Store chemical hose so it is protected from damage.
4. Store the machine and accessories in a dry, climate controlled environment. Do not store the machine or accessories in a place where the temperature could drop below 40 °F (4 °C).

**⚠CAUTION:** Risk of personal injury. Avoid placing hands between handle and frame when assembling to prevent pinching.

**NOTICE:** Risk of property damage. Always store and transport unit in an upright position.

### ACCESSORIES

Recommended accessories for use with your tool are available for purchase from your local dealer or authorized service center. If you need assistance in locating any accessory for your tool, please contact the FNA Group at [www.dewaltpw.com](http://www.dewaltpw.com), 1825 Greenleaf Avenue, Elk Grove Village, IL 60007, or call 1 (877) 362 4271.

**⚠DANGER:** Risk of fluid injection. When using replacement lances or guns with this pressure washer, DO NOT use a lance and/or lance/gun combination that is shorter in length than what was provided with this pressure washer as measured from the nozzle end of the lance to the gun trigger.

**⚠WARNING:** The use of any other accessory not recommended for use with this tool could be hazardous. Use only accessories rated equal to or higher than the rating of the pressure washer.

### SERVICE INFORMATION

Please have the following information available for all service calls:  
 Model Number \_\_\_\_\_ Serial Number \_\_\_\_\_  
 Date and Place of Purchase \_\_\_\_\_

### Repairs

To assure product SAFETY and RELIABILITY, repairs, maintenance and adjustment should be performed by a FNA factory service center, a FNA authorized service center or other qualified service personnel. Always use identical replacement parts.

### Limited Warranty

The manufacturer of this product agrees to repair or replace designated parts that prove defective within the warranty period listed below at the manufacturer's sole discretion. Specific limitations/extensions and exclusions apply.

This warranty covers defects in material and workmanship and not parts failure due to normal wear, depreciation, abuse, accidental damage, negligence, improper use, maintenance, water quality or storage. To make a claim under the terms of the warranty, all parts said to be defective must be retained and available for return upon request to a designated Warranty Service Center for warranty inspection. The judgments and decisions of the manufacturer concerning the validity of warranty claims are final.

These warranties pass through to the end user and are non-transferable. As a factory authorized and trained Warranty Service Center, the factory will honor the terms of all component warranties and satisfy claims of the appropriate warranty provisions.

Normal wear items include, but are not limited to, valves and seals, which are not covered by this warranty.

This warranty replaces all other warranties, express or implied, including without limitation any warranties of merchantability or fitness for a particular purpose and all such warranties are hereby disclaimed and excluded by the manufacturer. The manufacturer's warranty obligation is limited to repair and replacement of defective products as provided herein and the manufacturer shall not be liable for any further loss, damages, or expenses – including damages from shipping, accident, abuse, acts of God, misuse, or neglect. Neither is damage from repairs using parts not purchased from the manufacturer or alterations performed by non-factory authorized personnel. Failure to install and operate equipment according to the guidelines put forth in the instruction manual shall void warranty.

**This warranty does not cover the following:** machines used for rental purposes, damage resulting from shipping (claims must be filed with freighter), accident, abuse, act of God, misuse, or neglect. Neither is damage from repairs or alterations performed by non-

factory authorized personnel or failure to install and operate equipment according to the guidelines put forth in the instruction manual.

The manufacturer will not be liable to any persons for consequential damage, for personal injury, or for commercial loss.

**WARRANTY DOES NOT APPLY TO FAILURES DUE TO:**

- Freight damage
- Damage due to chemical deterioration, scale build up, rust, corrosion or thermal expansion
- Freeze damage
- Damage caused by parts or accessories not obtained from an authorized dealer or not approved by the manufacturer.
- Normal wear of moving parts or components affected by moving parts.

**MOTOR**

Covered by motor manufacturer warranty. See **motor manual**.

**HIGH PRESSURE PUMP (DEFECTS IN MATERIAL AND WORKMANSHIP)**

Five (5) years from date of purchase.

**FRAME (DEFECTS IN MATERIAL AND WORKMANSHIP)**

Ten (10) year from date of purchase.

**OTHER COMPONENTS (DEFECTS IN MATERIAL AND WORKMANSHIP)**

Includes nozzles, hoses, spray guns, wands, tires, feet

Ninety (90) days from date of purchase.

## Glossary

**Bypass mode:** Allows water to re-circulate within pump when the gun trigger is not pulled.

**Chemical hose:** Feeds cleaning agents into the pump to mix with the water. Refer to **Chemicals and Cleaning Solvents**.

**Chemical injection system:** Mixes cleaners or cleaning solvents with water to improve cleaning effectiveness.

**CU:** Cleaning Units. GPM multiplied by psi. (GPM x PSI = CU)

**GPM:** Gallons Per Minute. The unit of measure for the flow rate of water.

**PSI:** Pounds per Square Inch. The unit of measure for water pressure. Also used for air pressure, hydraulic pressure, etc.

**kPa (kilopascal):** Metric pressure measurement. 1 kilopascal equal 1000 pascals.

**Quick-connect spray wand:** Allows the user to quickly change out high-pressure nozzles. Refer to **Spray Wand Nozzles**.

**Thermal relief valve:** When the temperature inside the pump rises too high the valve will open and release a gush of water in an effort to lower the temperature inside the pump. The valve will then close.

**Water supply:** All pressure washers must have a source of water. The minimum requirements for a water supply are 20 psi (138 kPa) and 5 gallons per minute.

## Troubleshooting Guide

This section provides a list of the more frequently encountered malfunctions, their causes and corrective actions. The operator or maintenance personnel can perform some corrective actions, and others may require the assistance of a qualified FNA technician or your dealer.

Problem	Code
Motor will not start when switched ON.....	1, 11
When unit is switched ON, the motor hums but does not turn on .....	2, 3
The motor stops .....	4
No or low pressure (initial use) .....	5, 6, 7, 8, 9, 10, 12
Will not draw chemicals .....	12, 13, 14, 15, 16, 17, 32
No or low pressure (after period of normal use).....	18, 19, 20
Water leaking at gun/spray wand connection .....	21, 22
Water leaking at pump .....	21, 22, 23, 24
Oil leaking at pump .....	25, 26, 27, 28, 29, 30, 31
Pump Pulsates.....	8

### Troubleshooting Codes

CODE	POSSIBLE CAUSE	POSSIBLE SOLUTION
1	ON/OFF switch in OFF position.	Place ON/OFF switch in ON position.
2	The main voltage is insufficient, lower than the minimum required.	Check that the main power supply is adequate.
3	Extension cord is too long or wire gauge is too small.	We do not recommend the use of extension cords with your pressure washer. If you must use an extension cord, verify that it meets the minimum requirements listed in the <b>Extension Cord</b> paragraph under the <i>Power Supply &amp; Electrical Info</i> in this manual.
4	Tripped thermal overload due to overheating.	Allow to cool. Reset thermal overload button on pump motor.
5	Spray wand not in high pressure.	See <b>Spray Wand Nozzles</b> under <b>Operation</b> .
6	Low water supply.	Water supply must be at least 5 GPM @ 20 psi (138 kPa).
7	Leak at high-pressure hose fitting.	Repair leak. Apply sealant tape if necessary.
8	Nozzle obstructed.	See <b>Nozzle Cleaning</b> under <b>Maintenance</b> .
9	Water filter screen clogged.	Remove and clean filter.
10	Air in hose.	Turn off the engine, then the water source. Disconnect the water source from the pump inlet and turn the water source on to remove all air from the hose. When there is a steady stream of water present, turn water source off. Reconnect water source to pump inlet and turn on water source. Squeeze trigger to remove remaining air.
11	GFCI Plug is not reset	Confirm the GFCI plug is reset and functioning according to instructions provided in <b>Ground-Fault Circuit Interrupter Protection</b> paragraph under <i>Power Supply &amp; Electrical info</i> in this manual.
12	High-pressure hose is too long.	Use high-pressure hose under 100 feet (30.48 m). Lengthen water supply hose instead of high-pressure hose.
13	Spray wand not in low pressure.	See <b>Spray Wand Nozzles</b> under <b>Operation</b> .
14	Chemical filter clogged.	Clean filter.

CODE	POSSIBLE CAUSE	POSSIBLE SOLUTION
15	Chemical screen not in cleaning solution.	Make sure end of chemical hose is fully submerged into cleaning solution.
16	Chemical too thick.	Dilute chemical. Chemical should be the same consistency as water.
17	Worn seal or packing.	Have parts cleaned or replaced by authorized service center.
18	Chemical build up in chemical injector.	Have replaced by an authorized service center.
19	Worn or obstructed valves.	Have replaced by an authorized service center.
20	Worn unloader piston.	Have replaced by an authorized service center.
21	Worn or broken o-ring.	Check and replace.
22	Loose hose connection.	Tighten.
23	Piston packings worn.	Have replaced by authorized service center.
24	Pump head or tubes damaged from freezing.	Have replaced by authorized service center.
25	Oil seals worn.	Have replaced by authorized service center
26	Loose drain plug.	Tighten.
27	Worn drain plug o-ring	Check and replace.
28	Worn fill plug o-ring.	Check and replace.
29	Pump overfilled.	Check for correct amount.
30	Incorrect oil used.	Drain and fill with correct amount and type of oil.
31	Vent plug is clogged.	Clean vent plug; blow air through it to remove any blockage. If problem persists, replace plug.
32	Detergent adjustment knob is in the closed position.	Turn the adjustment knob counterclockwise to set the detergent adjustment to the MAX setting.