

COSTWAY[®]



USER'S MANUAL
Portable Air Conditioner
EP24618US

THIS INSTRUCTION BOOKLET CONTAINS **IMPORTANT** SAFETY INFORMATION. PLEASE READ AND KEEP FOR FUTURE REFERENCE.



Please give us a chance to make it right and do better!

Contact our friendly customer service department for help first.

Replacements for missing or damaged parts will be shipped ASAP!

Follow Costway

Visit us: www.costway.com



Contact Us!

Do NOT return this item.

Contact our friendly customer service department for help first.



Before You Start

- ⚠ Please read all instructions carefully.
- ⚠ Retain instructions for future reference.
- ⚠ Separate and count all parts and hardware.
- ⚠ Read through each step carefully and follow the proper order.
- ⚠ We recommend that, where possible, all items are assembled near to the area in which they will be placed in use, to avoid moving the product unnecessarily once assembled.
- ⚠ Always place the product on a flat, steady and stable surface.
- ⚠ Keep all small parts and packaging materials for this product away from babies and children as they potentially pose a serious choking hazard.

Contents

Important Safeguards.....	4
Function Description.....	5
Features and Parts.....	5
Installation.....	6
Control Setting.....	9
Water Drainage Methods.....	11
Maintenance.....	12
Handling of the Unit	14
End of Season Storage	14
Troubleshooting.....	15
Appendix.....	16

Thank you for selecting this super quality air-conditioner. Please keep this User's Manual properly for future reference. Read the User's Manual carefully before operating this unit.

Important Safeguards

Important safeguards:

- * This air-conditioner is suitable for indoor use only rather than for other occasions.
- * Rated operating range: this unit shall be connected to 110-120V / 60Hz power output end.
- * The air-conditioner shall be installed in accordance with the wiring rules of local grid to ensure proper grounding. Should you have any question about electrical installation, follow the User's Manual or have the installation done by professional electrician whenever necessary.
- * Please put this unit in a flat and dry place and keep it at least 20in away from surrounding objects or walls.
- * Once the air-conditioner is installed, ensure that the plug wire is in good condition and inserted firmly into the power socket and always ensure that the power cord is arranged in order to prevent the personnel from stumbling over it or the plug from being pulled out.
- * Do not insert any object into the air inlet/outlet of the air-conditioner. Be sure to keep the air inlet/outlet of the air-conditioner unblocked.
- * Where there is the need to install a drain pipe, ensure that the connection of the drain pipe is in good condition without flexure.
- * When adjusting the horizontal/vertical louver at the air outlet, turn it slightly by hand to avoid damage of the louver.
- * Keep the unit in an upright position when moving it.
- * Keep this unit away from gasoline, flammable gases, oven or other heat sources.
- * Do not dismantle, inspect or modify the unit without authorization as this may result in fault of the unit, and even bodily injury & property damage; to avoid dangers, if the unit is faulty, be sure to have it repaired by the manufacturer or professionals.
- * Do not install and operate this air-conditioner in a bathroom or other wet environments.
- * Do not allow the children to play with this machine. Closely supervise the children or disabled people when this unit is in use.
- * Do not turn off this unit by removing the plug.
- * Do not place such objects as cups on the unit to prevent water or other liquids from spilling into the air-conditioner.
- * Do not use pest control aerosol or other flammable substances near the air-conditioner.
- * Do not wipe or wash the air-conditioner with chemical solvents such as gasoline and

alcohols, etc. Before cleaning the air-conditioner, be sure to turn off the power supply and wipe it with soft semi-wet cloth; if the machine is indeed very dirty, wipe it with neutral cleaner.

Recommendation:

Do not operate this unit if the ambient temperature is greater than 95 °F in the cooling mode or lower than 41 °F in the heating mode.

Function Description

This series of mobile air-conditioners are available in cooling only and cooling & heating models of different sizes. The cooling only models offer the cooling, dry, air blowing and sleep functions; the cooling & heating models offer the cooling, dry, air blowing and heating functions. The speed of the fan is adjustable between high fan speed and low fan speed, the temperature setting range is 60-86 °F, and various protection functions such as (24h) timed ON/OFF setting.

Features and Parts

1. Features

- 1) Brand new appearance, compact structure with a sense of streamline.
- 2) The appearance of the unit is beautiful and elegant; the remote control can be placed on the right of the handle at the back of the unit, and the remote control features user-friendly memory design.
- 3) The structure of the power cord at the back and the universal jack design can better protect the power cord.
- 4) The position of the outdoor connector is high to allow for convenient assembly and smooth air flow of the heat exhaust hose.
- 5) Timed start/shutdown function, unique start/shutdown music.
- 6) 3-minute delay compressor restart protection function, multiple other protection functions.
- 7) The free snap-fit design of the heat exhaust hose allows for more convenient installation of the unit.

2. Parts:

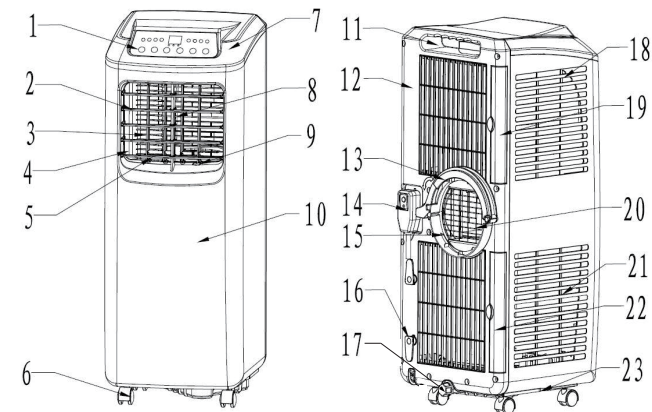

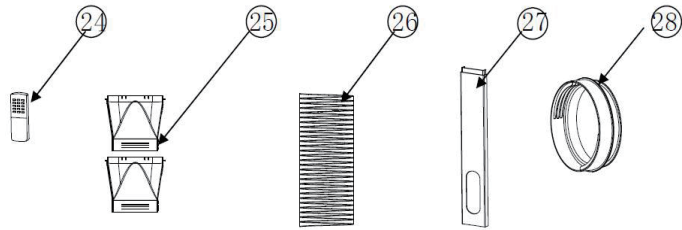

- | | |
|---|-----------------------------------|
| 1. Control panel | 15. Lower air duct bottom |
| 2. Horizontal louver | 16. Wire-winding post |
| 3. Vertical louver | 17. Drain cap |
| 4. Air outlet frame | 18. Evaporator filter mesh |
| 5. Vertical Louvre connecting lever | 19. Evaporator filter frame |
| 6. Caster | 20. Radiating fine mesh |
| 7. Top cap | 21. Condenser filter mesh |
| 8. Horizontal louver connecting lever | 22. Condenser filter frame |
| 9. Main vertical louver | 23. Base plate |
| 10. Front shell | 24. Remote control |
| 11. Handle position (right side: remote control storage area) | 25. Adapter |
| 12. Back shell | 26. Heat exhaust hose |
| 13. C shape buckle of the heat exhaust hose snap | 27. Window sealing board assembly |
| 14. Power cord | 28. Circular connector |

Installation Adjustment

1. Installation:

Warning: leave this mobile air-conditioner in an upright position for at least 2 hours before first use.

This air-conditioner may be moved indoor conveniently; leave the air-conditioner in an upright position while moving it. The air-conditioner shall be placed on a flat ground surface. Do not install or operate this air-conditioner in a bathroom or other wet environments.

1.1 .Installation of the C shape buckle of the heat exhaust hose and unit

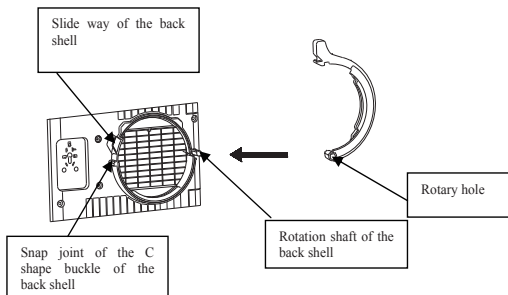

Figure 1

- 1) Take out the C shape buckle of the heat exhaust hose and remove the plastic bag.

- 2) Point the rotary hole at the end of the heat exhaust hose snap toward the rotation shaft of the back shell and slide it onto the back shell in accordance with the snap joint direction of the rotation shaft on the back shell (as shown in Figure 1).

Note: 1. When the end snap joint at the end of the rotation shaft of the back shell sticks out of the snap, it means that the heat exhaust hose snap has been slid into place.

- 3) Rotate the C shape buckle of the heat exhaust hose that is sided into place counterclockwise to clip the snap joint of the C shape buckle of the back shell successfully through the guide of the slide way of the back shell (as shown in Figure 2).
- Note: 1. Do not rotate the C shape buckle of the heat exhaust hose if it is not sided into place as this may damage the rotation shaft of the back shell and the C shape buckle of the heat exhaust hose.

1.2 Installation of the heat exhaust hose assembly and unit

- 1) Pull the end of the heat exhaust hose apart by several turns;
- 2) Hold the end handle of the C shape buckle of the heat exhaust hose with the right hand and the heat exhaust hose short connector with the left hand, put one end of the heat exhaust hose that is pulled apart onto the snap of the lower air duct bottom, press the C shape buckle of the heat exhaust hose with the left hand by force so that the C shape buckle of the heat exhaust hose clips the snap joint of the back shell (as shown in Figure 3)

Note: 1.The end of the heat exhaust hose must reach one step inside the bottom of the lower air duct (as shown in Figure 4).

2.The few turns at the end of the heat exhaust hose must be snapped in the snap of the lower air duct bottom.

3.The C shape buckle that clips the heat exhaust hose must clip the back shell and heat exhaust hose firmly.

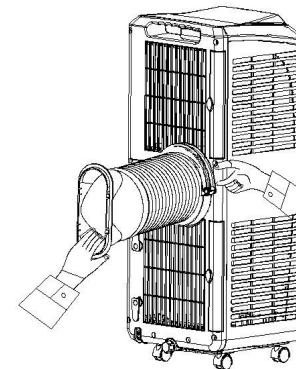

Figure 3

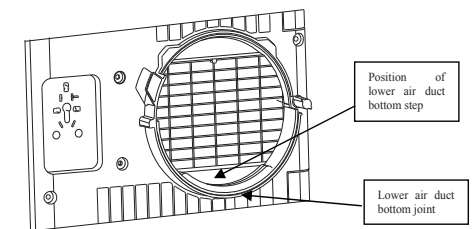

Figure 4

- 3) Hold the unit with one hand and the heat exhaust hose short connector with another hand; or both people cooperate with one person holding the unit and the other person pulling the heat exhaust hose to prolong the heat exhaust hose gently.

Note: 1. Do not separate the heat exhaust hose assembly from the unit.

2. Do not tilt the unit when pulling apart the heat exhaust hose.

1.3 Installation of the window sealing board assembly

- 1). Half open the window and mount the window sealing board assembly onto the window,

either vertically or horizontally (as shown in Figure 5 and 6).

2). Pull apart the parts of the window sealing board assembly, adjust the distance of the window sealing board assembly pulled apart so that the two ends of the assembly come into contact with the window frame, and fasten the parts of the assembly with copper screws.

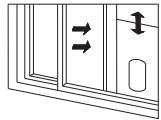

Figure 5

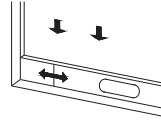

Figure 6

1.4 Installation of the unit

1). Move the machine with the heat exhaust hose assembly installed before the window and keep the unit at least 20in away from the walls or other objects. (As shown in Figure 7).

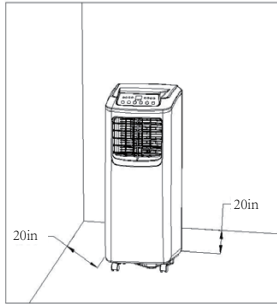

Figure 7

2). Snap the flat end of the heat exhaust hose short connector into the elliptical hole of the window sealing board assembly (as shown in Figure 8 and 9).

Note: 1. The flat end of the heat exhaust hose short connector must be snapped into place.

2. The heat exhaust hose may not be bent and shall be free from significant (greater than 45°) flexure, and the heat exhaust hose shall be ventilated properly.

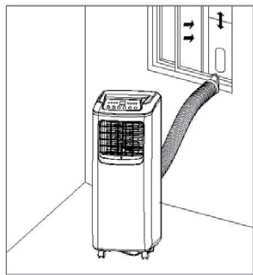

Figure 8

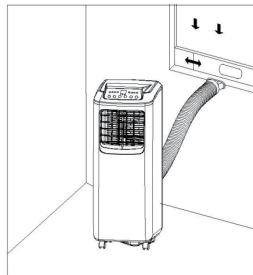

Figure 9

Important notes:

The exhaust hose is 11in-59in long and this length is determined based on the

specification of the air-conditioner (s). Do not use prolonged hose or replace with other different hoses as this may affect the functions of the air-conditioner. The exhaust must be smooth and the air-conditioner may overheat if the exhaust is obstructed.

Control Setting

One. Operation instructions of the control panel

1. Select the operation interface depending on the models and functions. The operation interfaces is as follows:

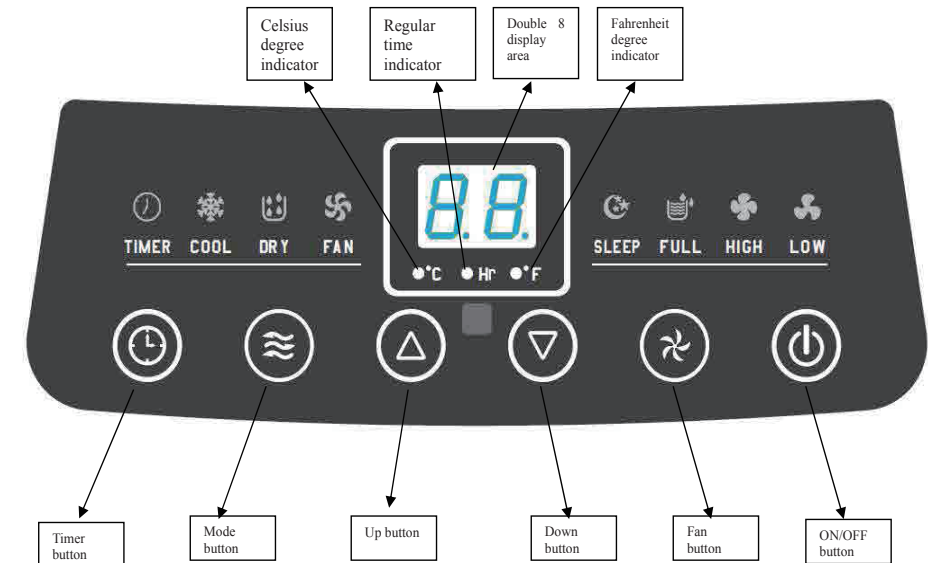

Functions Setting

This portable air conditioner has three functions: cooling, dehumidifying and fan. Fan has two speeds: high speed and low speed, setting temperature is 16--30°C (60~86°F), 24 hours timer, sensor and water-level protective function.

Buttons: There have six keys on the control panel: POWER, Mode, Fan Speed, Timer, Up key and Down key .

- POWER Key:** Press the key to start the unit ,and press this key again to turn unit off.
- Mode Key:** Set the Cooling , Dehumidifying and Fan Mode when the unit is working or under Timer-on situation.
- Fan Speed:** Pressing the button, the fan speed will change in a low - high-low circle, but it is not available in dehumidifying mode by low - high - low loop manner, but not available in dehumidifying mode.
- Timer Key:** Can set the Timer-Off function in unit working situation, when setting the time, the regular time indicator will illumine; can adjust the time again while the regular time indicator will illumine; then it will display the room temperature again in the Off mode. Can also set in the Timer-On function, same as above setting.

After the Timer-Off or the Timer-On, the Timer indicator lights.

e). **Up/Down Key:** Press this two key to set the desired room temperature. (Press the Up key once, the temperature will increase by 1°C or 1°F, also press the down key to decrease by 1°C or 1°F), can also set the time in Timer situation; can also exchange from °C to °F display by pressing these two keys at the same time.

* If users want to display the temperature in °C, they can use the buttons on the remote control or press the up and down keys simultaneously.

2. Operation instructions:

a) In the Cooling models:

Under cool mode, user can choose High or Low fan speed. The range of setting temperature is 16-30°C (60-86 °F)

In the mode, pressing Timer and Down button can senter sleep function, In sleep function, the set temperature increases 1°C(1°F) automatically two hours later.

After operating for another 2 hours, the set temperature will increase 1°C(1°F) again. Then, the set temperature will not change.

b) In the dry mode, if the ambient temperature $\geq 17^{\circ}\text{C}$ (62°F), the compressor will start. Then, the unit is controlled in the following manner: when the ambient temperature $\leq 15^{\circ}\text{C}$ (59°F), the compressor shuts down. When the ambient temperature rises to be $\geq 17^{\circ}\text{C}$ (62°F), the compressor starts again. The start/stop of the compressor meets the requirement for 3-minute protection time.

c). Under the fan mode, fan motor works while the compressor doesn't. Temperature setting is in vain. The low fan speed is forced.

3.Timer setting

a) Upon start, press the Timer button to enter timed shutdown. Upon shutdown, press this button to enter timed start. In the meanwhile, the timer indicator will illuminate.

b) Press the Timer button to enter the timing function (timed start/timed shutdown). Adjust the up or down button to set the timing. The time will cycle in the order of 1 – 2 – 3 –24 – 0 – 1 hours or 24 – 23 – 22 –1 – 0 – 24 hours. The adjustment time of the timing function is relative time.

c) After timed start is set, once the timed start time is reached, the unit will start. In the meanwhile, the timer indicator will extinguish and the ambient temperature is displayed.

d) After timed shutdown is set, once the timed shutdown time is reached, the unit will shut down. In the meanwhile, the timer indicator will extinguish and the ambient temperature is displayed.

e) Only the last setting of the timing function is valid.

f) ON/OFF operations caused by the button or remote control will clear all timing settings.

g) Once the timing is determined, if the timer button is pressed once, it is possible to query the remaining timed start/shutdown time. If the timer button is pressed twice continuously within 5s, it is possible to cancel timing.

h). The up and down buttons can be used to change the set value of the timer.

Two. Operation instructions of the remote control:

The operation instructions of the buttons of this simple remote control are as follows:

1. Power button: press this button to turn on/off the unit;
2. Timer button: upon shutdown, press this button to set timed start; upon start, press this button to set timed shutdown.
3. High button: press this button to allow the unit to operate in the high fan speed state (except in the dry and sleep modes);
4. Low button: press this button to allow this unit to operate in the low fan speed state;
5. Up button: press this button to increase the temperature and timing value;
6. Down button: press this button to decrease the temperature and timing value;
7. °C — F button: press this button to switch between the Celsius degree and Fahrenheit degree;
8. Cool button: press this button to set this unit to operate in the cooling mode;
9. Fan button: press this button to set this unit to operate in the air supply mode;
10. Dry button: press this button to set this unit to operate in the dry mode;
11. Sleep mode: press this button to set this unit to operate in the sleep mode.

Three. Multiple protection functions:

1. Anti-freeze protection function:

Upon cooling, when the compressors operates continuously for more than 10 minutes, if the pipe temperature T_p is less than or equal to 34°F continuously for 20 seconds, the compressor and water spraying motor turn off, other loads operate and LED displays **E4**, the unit initiates the anti-frost protection function and the buttons are inactive (except the OFF button). Once the pipe temperature rises to exceed or equal 46°F, the protection is relieved, the original status is restored and the unit meets the requirements for 3-minute delay protection of the compressor.

2. Full water protection function:

When the water in the water tray exceeds the alarm level, the unit will alarm automatically and the full water indicator illuminates. In this case, you need to drain the condensate in the unit; otherwise, the unit will shut down automatically after the buzzer gives off 5 beeps. (For more information about the drain method, refer to the "Drain"). If the unit is not shut down manually, the unit will be restored to the previous operating status automatically once the water is fully drained. Or the power may be turned on again to start the unit.

3. Delay protection function of the compressor

This unit offers restart protection for the compressor. Except that the compressor may start immediately when the unit is energized for the first time, there is 3-minute delay start protection after the compressor is shut down.

Water Drainage

1. Manual drain: (as shown in Figure 10)

1). Once the unit shuts down upon full water, turn off the power of the unit and then unplug the power plug.

Note: move the unit carefully to avoid spillage of water in the water tray at the bottom of the unit.

2). Put the vessel that holds water below the water outlet at the back of the unit.

3). Screw off the drain cap, unplug the water plug and water will flow into the vessel that holds water automatically.

Note: 1. Protect the drain cap and water plug properly.

2. Tilt the unit slightly backward when draining.

3. If the vessel that holds water can not hold all water in the unit, before the vessel that holds water is full of water, block the water outlet with the water

plug as soon as possible to prevent the water from flowing onto the ground or carpet.

- 4). Once the water is fully drained, insert the water plug and screw on the water cap tightly.
Note: 1. Turn on the unit only after the water plug and drain cap are installed properly; otherwise, the condensate of the unit will flow onto the ground or carpet.

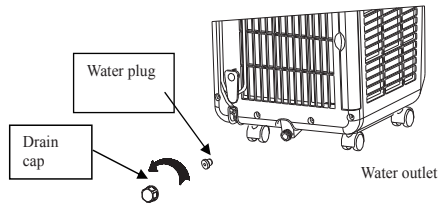

Figure 10

2. Continuous drain:

- 1). Screw off the water cap in the direction shown by the arrow and unplug the water plug; (Figure 11)
- 2). Insert the OD 0.5in PVC drain hose 0.3in-0.4in into the water outlet; (Figure 12)
- 3). Connect the drain hose to the WC or outdoor.

- Note:
1. The drain hose must be installed when there is no water in the baseplate;
 2. When operating in the cooling mode, to ensure the water for radiation of the condenser of the unit and enhance the cooling effects of the unit, it is recommended that continuous drain not be set as far as possible when this unit is in use;
 3. Put the drain hose in an inaccessible place at a height not above the water outlet and keep the drain hose free from flexure;
 4. When continuous drain is adopted, keep the drain cap and water plug properly.

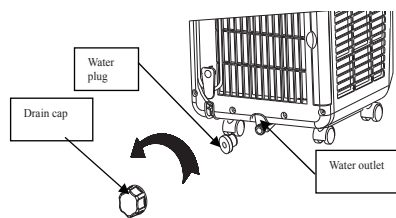

Figure 11

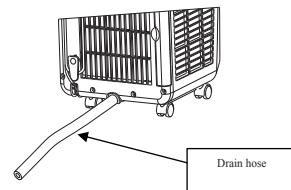

Figure 12

Maintenance and Servicing

Prior to maintenance and servicing of the unit, turn off the power and unplug the plug.

1. Surface cleaning

Clean the surface of the unit with wet soft cloth. Do not use chemical solvents such as alcohol and gasoline; otherwise, the surface of the air-conditioner may be damaged and even the whole unit may be damaged.

2. Cleaning of the filter frame and filter mesh

Clean the filter mesh once every two weeks. If the filter frame and filter mesh are clogged with dust, the function of the air-conditioner may decrease

2.1 Cleaning of the filter frame and filter mesh

- 1). Hold the gripping position of the evaporator filter frame and the condenser filter frame and take out the filter frame gently in the direction shown by the arrow (as shown in Figure 13).
- 2). Hold the gripping position of the evaporator filter mesh and condenser filter mesh and take out the filter mesh gently in the direction shown by the arrow (as shown in Figure 14).

Note: when taking out the filter frame or filter mesh, the force shall be applied evenly to avoid twisting or damage of the filter frame or filter mesh. Be sure to take out the filter frame first and then take out the filter mesh.

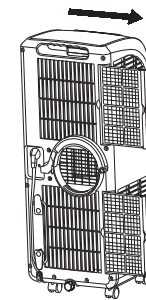

Figure 13

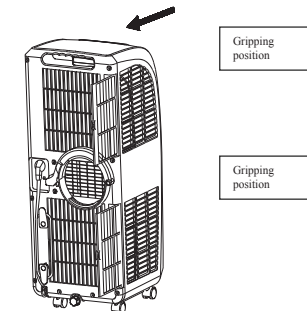

Figure 14

- 3). Put the evaporator filter frame, condenser filter frame, evaporator filter mesh, and condenser filter mesh into warm water (about 104°F) to which neutral cleaner is added for cleaning and then dry them in the shade (as shown in Figure 15).

Note: 1. Do not damage the mesh fabric on the filter frame and filter mesh.

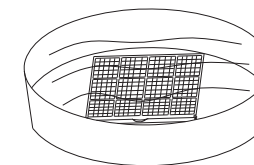

Figure 15

2.2 Installation of the filter frame and filter mesh

Special note: be sure to install the filter mesh first and then install the filter frame.

- 1) To install the evaporator filter mesh and condenser filter mesh, point the back end of the filter mesh toward the socket and then push the filter mesh evenly and gently into the socket.
Note: 1. Install the filter mesh in the reverse order of removal. The filter mesh must be installed into place; otherwise, the filter frame may not be installed into place.
2. Install the filter mesh gently so as not to damage it.
- 2). To install the evaporator filter frame and condenser filter frame, point the back end of the filter frame toward the socket and then push the filter frame evenly and gently into the socket.
Note: 1. Install the filter frame in the reverse order of removal. Be sure to install the filter mesh first before the filter frame is installed.
2. Install the filter frame gently so as not to damage it

3. Cleaning of the handle position and remote control storage area

- 1). Take the remote control out of the remote control storage area in the direction shown by the arrow; (as shown in Figure 16)

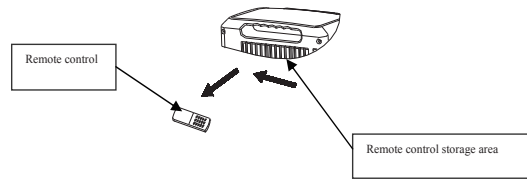

Figure 16

2). Clean the handle position and remote control storage area of this unit with wringed wet soft cloth;

Note: the wet soft cloth must be wringed out. Do not drip water into the unit.

3). If the remote control needs to be put back into the remote control storage area, put it back into the storage area in the reverse direction of removal.

Handling of the Unit

1. Handling and moving of the unit

1). To handle or move the unit, hold the top of the air outlet of the front shell with one hand and the handle position at the top of the back shell with another hand, and leave the unit in the upright position. (As shown in Figure 17).

Note: 1. Do not hold the horizontal louver by hand.

2. Leave the unit in the upright position when handling or moving it.
3. To handle or move the unit, drain the water in the unit first to prevent the water in the unit from flowing onto the ground or carpet.
4. If the remote control is in the position of the handle, take out the remote control.

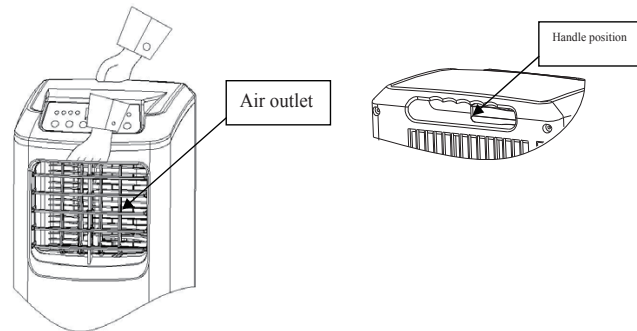

Figure 17

End of Season Storage

1. Screw off the drain cap, unplug the water plug and drain the water in the water tray to

another vessel that holds water.

Note: the tilt angle of the unit shall not be greater than 30 degrees.

2. Start the unit, turn the mode to the low fan speed state of the air supply mode, keep this state for half a day and dry the interior of the unit to prevent mold.
3. Turn off the unit, unplug the power plug, wrap the power cord around the wire-winding post, insert the plug into the universal jack at the back shell of the unit; install the water plug and drain cap.
4. Remove the heat exhaust hose assembly and keep it properly.

Note: to remove the heat exhaust hose assembly, hold the handle of the C shape buckle of the heat exhaust hose by hand, pull the C shape buckle outward evenly, rotate the C shape buckle of the heat exhaust hose clockwise once the buckle is separated from the snap position of the C shape buckle of the back shell and then take out the heat exhaust hose assembly.

5. Pack the air-conditioner properly with soft plastic bag, put the unit in a dry place & take appropriate dust-proof measures, and keep the unit out of the reach of children.
6. Take out the batteries of the remote control and keep it properly.

Note: ensure that the unit is put in a dry place. All accessories of the unit shall be protected properly.

Troubleshooting

Never repair or remove the air-conditioner yourself. Disqualified repair will void the warranty card and may cause harm to the removal personnel and property. If you encounter any of the problems listed in the table below or the recommended remedy does not work, contact the professional service agency.

Problem/fault indication	Cause	Remedy
The air-conditioner does not work	No power	Connect the unit to a live socket and turn it on.
	Full water indicator illuminates?	Drain the water stored in the unit.
	Ambient temperature too low ?	It is recommended that this unit be operated at 41-95 °F .
Bad cooling or heating effects	The room temperature is lower than the set temperature in the cooling mode.	Change the set temperature
	There is direct sunlight	Draw the curtain on.
	The doors and windows are open, the room is crowded or there are other heat sources in the cooling mode	Close the door and window and add new air-conditioners
Large noise	Filter mesh very dirty	Clean or replace the filter mesh
	Air inlet or air outlet clogged	Remove the obstruction
The compressor does not work	Air-conditioner not put on a flat surface	Put the air-conditioner in a flat and firm place (may reduce noise)
The remote control does not work	Initiation of overheat protection.	Wait 3 minutes until the temperature decreases and then turn on the unit
	Too long a distance	Bring the remote control close to the air-conditioner and ensure that the remote control points toward the receiving head of the remote control.
	The remote control does not point toward the receiving head of the remote control	Replace the batteries
Display E1	The batteries have no electricity	Replace the batteries
Display E2	Pipe temperature sensor failure	Check the pipe temperature sensor and related circuits
	Room temperature sensor failure	Check the room temperature sensor and related circuits

Display E4	Anti-freeze protection	Restore the functions automatically once defrozen.
Full water indicator illuminates	The water in the base plate of the unit reaches the full water level	Drain the water in the base plate.

Appendix

Fuse parameters

Voltage: 250V

Current: 3.15A

Schematic diagram of the air-conditioner

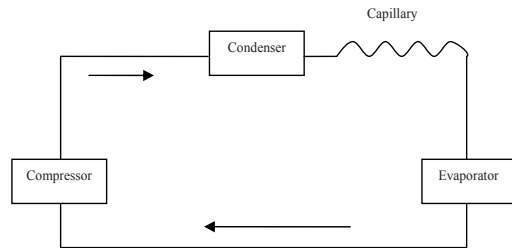

For specific technical parameters of the models, refer to the nameplate on the product (s).



Disposal: do not store waste products with other non-classified wastes. Such wastes shall be stored separately for other special purposes.

Welcome to visit our website and purchase our quality products!

Your suggestions and comments for COSTWAY are really important to us! We sincerely solicit you to go back to our shop and leave a good rating in just a simple click. It would be quite encouraging if you could kindly do so like below:

★★★★★ Great products so far

February 24, 2019

Great products so far. Fast delivery, easy setup, and working without any issues.

With your inspiring rating, COSTWAY will be more consistent to offer you EASY SHOPPING EXPERIENCE, GOOD PRODUCTS and EFFICIENT SERVICE!

US office: Fontana, California

UK office: Ipswich



- * Reward Points
- * Exclusive Customer Service
- * Personalized Recommendations
- * Permanent Shopping Cart
- * Order History

5 Star Rating



We would like to extend our heartfelt thanks to all of our customers for taking time to assemble this product and giving us valuable feedbacks.

THANK
you
☺