

BLUETTI AC500

User Manual

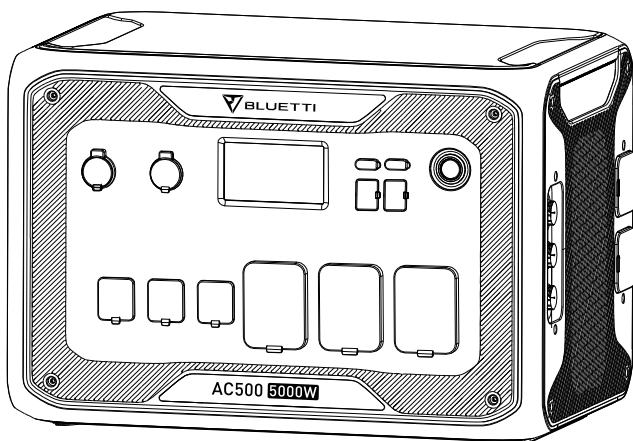

Thank You

Thank you for making BLUETTI a part of your family.

From the very beginning, BLUETTI has tried to stay true to a sustainable future through green energy storage solutions for both indoor and outdoor use while delivering an exceptional eco-friendly experience for our homes and our world.

That's why BLUETTI makes its presence in 70+ countries and is trusted by millions of customers across the globe.



CONTENTS

Before You Begin	4
Safety Instructions	5
General Safety	5
Maintenance	6
Handling & Storage	6
What's In The Box	7
Standard Packaging	7
Product Overview	9
Diagram	9
Specifications	10
Operation	12
Powering On/Off	12
LCD Screen	12
Charging	14
Discharging	17
Capacity Expansion	18
UPS	20
Power Lifting Mode	22
BLUETTI App	22
Split Phase System	24
Appendix	25
FAQs (Frequently Asked Questions)	25
FCC Warning	26
Technical Support	27

Before You Begin

The information contained herein is subject to change without notice.

For the latest version, please visit <https://www.bluettipower.com/pages/user-guides>.

- The user manual contains instructions and notes on the operation and use of this unit.
- BLUETTI recommends that you use genuine accessories from BLUETTI.
- BLUETTI shall not be responsible for any damage or expense that might result from the use of parts other than genuine parts from the BLUETTI.
- For your safety and benefit, please read carefully before using and keep it handy for future reference.

Safety Instructions

General Safety

BLUETTI products are developed to be safe and reliable. Please read this guide for important safety information about your device. The guide is intended to help you be more comfortable and productive while using this device. Failure to follow these guidelines for proper set up, use, and care for your device may cause damage to this unit and injury to yourself or others.

SAVE THESE INSTRUCTIONS!

- Always operate or store the unit in accordance with specified temperature range.
- DO NOT expose the unit to fire, liquids, sweat, dirt or other contaminants, as that may cause fire or electric shocks.
- DO NOT place the unit on an unstable or tilted surface.
- Make sure the place where you are using the unit is well ventilated and spacious.
- Keep away from children and pets.
- DO NOT ignore those warning signs on components or products made by manufacturers.
- DO NOT dismantle, cut, crush, puncture, or otherwise damage the unit in any way.
- DO NOT insert foreign objects into the fan, vents, ports, or other openings.
- NEVER use a damaged battery or component. Improper use or misuse of damaged batteries may cause damage to your device or injury to yourself as a result of battery fluid leakage, fire, overheating, or explosion.
- Use approved battery and accessories ONLY. Improper use, or use of unapproved or incompatible batteries or components may result in a risk of fire, explosion, or other hazards, and may invalidate any approval or warranty.
- Turn off the unit IMMEDIATELY in case of malfunction.
- Use dry powder fire extinguisher in case of fire.

- DO NOT attempt to modify, replace the internal components of the unit by anyone other than qualified personnel. If necessary, take it to an authorized service center as incorrect reassembly may result in a risk of fire or electric shock.

SAVE THESE INSTRUCTIONS!

Maintenance

- When not using the unit for extended periods of time, power off the unit and disconnect from the outlet.
- Charge the unit to 50-70% SOC every 6 months for long-term storage.
- Clean the unit with a dry cloth gently and carefully.

Handling and Storage

- Use mechanical assistance as needed (e.g. trolleys and adjustable height workbenches).
- DO NOT stack anything on top of the unit either in storage or in use.
- Recommended storage temperature: -13-104°F/-25-40°C.

What's In The Box

Standard Packaging

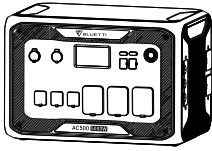

Portable Power Station

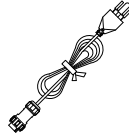

15A AC Charging Cable

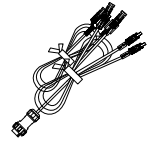

DC Input Cable



Car Charging Cable



User Manual



Warranty Card

* Below accessories are not included in standard packaging and can be purchased separately at <https://www.bluettipower.com/>.

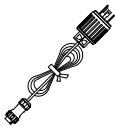

30A AC Charging Cable

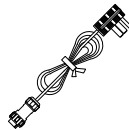

50A AC Charging Cable



Lead-acid Battery
Charging Cable



D300S PV Voltage Step
Down Module

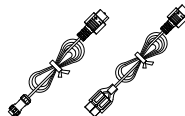

30A RV Cable



Cigarette Lighter-F to
DC5521 Cable (24V)

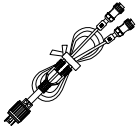

Split-phase AC Charging Cable



USB-C to USB-C Cable



Communication Cable

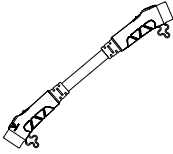

P150D to P090D Cable

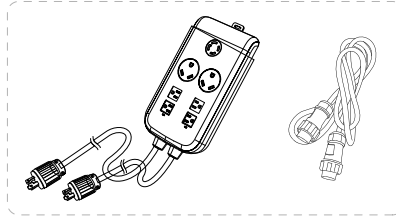

P030A Fusion Box

* **15A AC Charging Cable:** 63in/160cm.

DC Input Cable: 63in/160cm. Aviation-MC4.

Car Charging Cable: 25.6in/65cm. Cigarette Lighter Port-MC4.

30A AC Charging Cable: 63in/160cm.

50A AC Charging Cable: 59in/150cm.

Lead-acid Battery Charging Cable: 20in/50cm. Clamp-MC4.

D300S PV Voltage Step Down Module: 65in/165cm(output cable).

30A RV Cable: Aviation-XT90, 59in/150cm;
XT90-SPC45, 20in/50cm.

Cigarette Lighter-F to DC5521 Cable(24V): 38in/72cm.

Split-phase AC Charging Cable: 59in/150cm.

USB-C to USB-C Cable: 79in/200cm.

Communication Cable: 59in/150cm.

P150D to P090D Cable: 31.5/80cm.

P030A Fusion Box: 122in/310cm; 73in/185cm.

Note: All measurements are for reference only.

Package details are subject to change without prior notice.

Product Overview

Diagram

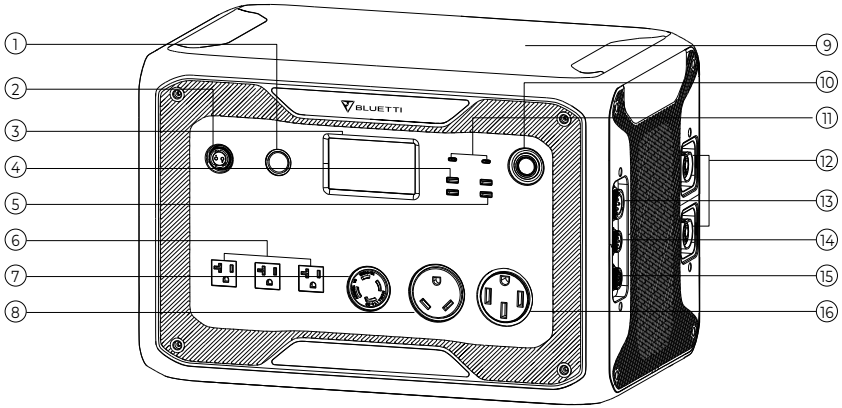

- | | |
|-----------------------------------|----------------------------|
| 1. 24V/10A Cigarette Lighter Port | 9. Wireless Charging Pad |
| 2. 12V/30A RV Port | 10. Power Button |
| 3. LCD Screen | 11. USB-C PD3.0 |
| 4. 18W USB-A Port | 12. Battery Expansion Port |
| 5. USB-A Port | 13. AC Input |
| 6. AC Output | 14. DC1/DC2 Input |
| 7. L14-30R Port | 15. Communication Port |
| 8. TT-30R Port | 16. NEMA 14-50R Port |

Specifications

AC500		
General		
Battery Capacity (With 1-6 B300S)	3072-18432Wh/60-360Ah	
Dimensions (L*W*H)	20.5*12.8*14.1IN/520*325*358MM	
Weight	66.2LB/30KG	
Discharging Temperature	-4-104°F/-20-40°C	
Charging Temperature	-4-104°F/-20-40°C	
Storage Temperature	-13-104°F/-25-40°C	
Over Temperature Protection (With B300S)	Discharging	65°C (Recovery at 55°C)
	Charging	55°C (Recovery at 45°C)
Working Humidity	10-90%	
AC Output		
Power	5000W	
Surge	10000W	
Voltage	100-120VAC	
Current	41.7A	
Frequency	50/60Hz	
Overload	5000-6000W, 2min	
	6000-7500W, 5s	
	7500-9000W, 500ms	
DC Output		
Cigarette Lighter Port *1	Voltage	24VDC
	Current	10A
12V/30A RV *1	Voltage	12V
	Current	30A
	Overload	418W, 2s
USB-A *2	Voltage	5VDC
	Current	3A
USB-A QC3.0 *2	Power	18W Max. (3.6-12VDC, 3A)
USB-C PD3.0 *2	Power	100W Max. (5/9/12/15/20VDC, 3A; 20VDC, 5A)
Wireless Charging *2	Power	15W Max.

AC Input	
Power	5000W Max.
Voltage	90-264VAC
Current	50A Max.
DC Input	
Power	3000W Max.
Voltage	12-150VDC
Current	15A Max.

Note: If there's only one B300S, the combo gets a maximum AC output of 4500W.

With the 15A AC charging cable, the combo gets a maximum of 1500/1800W AC input (1500W for 100VAC version, 1800W for 120VAC version).

When connecting B300S with the T500 adapter or AC500 to the grid, B300S is able to self-heat and get charged even at -4°F/-20°C.

Operation

Powering On/Off

Powering on: Press the power button either on AC500 or B300S and hold for at least 1s to start up the combo.

AC/DC Output: Tap the 'AC ON/OFF' or 'DC ON/OFF' to enable or disable.

Operation	Green Light(On the Buttons)	LED Indicator(On B300S)
Powering On	ON	ON
Powering Off	OFF	OFF

Note: Turn on the DC power to enable wireless charging.
When connected to the grid or PV, the combo turns on automatically.

Powering Off: Press the power button either on AC500 or B300S to shut down the combo.

Note: The combo turns off automatically upon 4 hours:
a: No input and output b: AC and DC output off

LCD Screen

Homepage

This section displays the charge/discharge status and navigates to detailed product information.

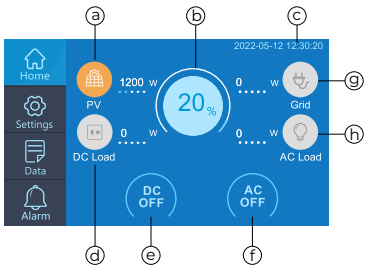

- a: PV Input
- b: Battery Capacity
- c: Date/Time
- d: DC Load
- e: DC ON/OFF
- f: AC ON/OFF
- g: Grid Input
- h: AC Load

Settings

This section provides general setting configurations, including language, AC/DC output and input, ECO Mode¹, machine type, system date/time, etc.

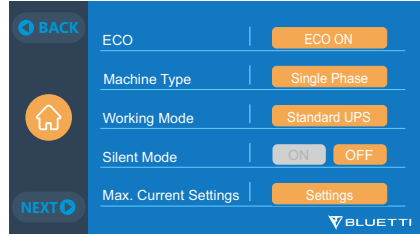
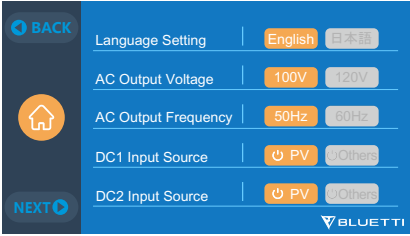

Note: Check all the settings before first use.

AC frequency can only be adjusted after AC output is turned off.

Voltage and Frequency Reference:

US: 120V/60Hz JP: 100V/50Hz/60Hz EU: 230V/50Hz

UK: 230V/50Hz AU: 240V/50Hz

Data

This section provides all basic information including product, input and output, battery, and alarm history.

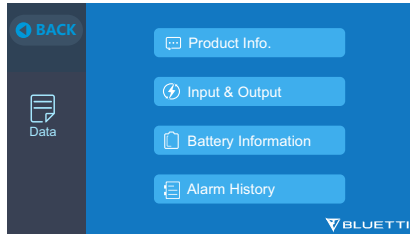

Note: 'Input & Output' indicates the input and output status of this unit;

'Battery Information' indicates the connection status of battery pack(s);

'Alarm History' records all alarms generated which can be manually deleted.

¹On this mode, the AC output will automatically turn off after 4-hour low ($\leq 30W$) or no load to save power.

Charging

AC Charging

(1) Consider the specifications of public utility, wall outlet and AC charging cable before setting the Max. Grid Input Current.

Note: The Max. Grid Input Current is set at 15A by default and only works when AC500 connects to the grid.

Email to BLUETTI Customer Service for password.

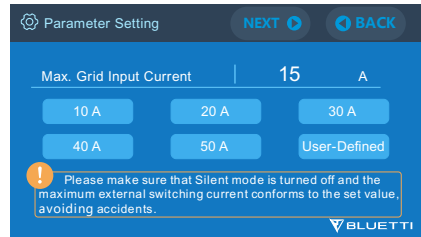
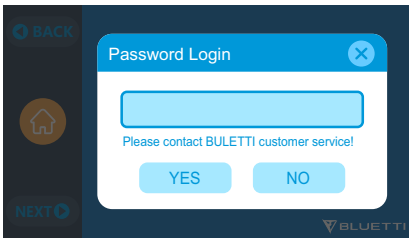

(2) Plug the AC500 into the wall outlet with 15A/30A/50A AC charging cable or tie it to the grid with the smart home panel.

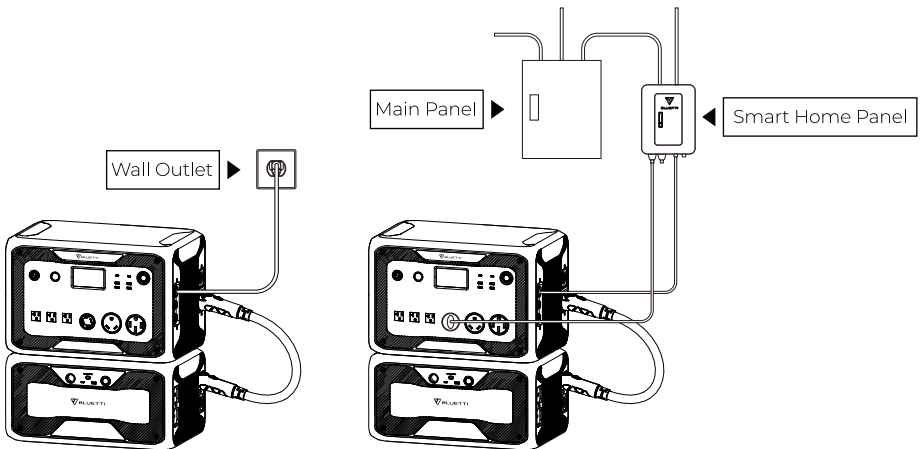

Note: If there's only one B300S, the combo gets a maximum AC output of 4500W.

With the 15A AC charging cable, the combo gets a maximum of 1500/1800W AC input (1500W for 100VAC version, 1800W for 120VAC version).

PV Charging

AC500 supports dual PV input with the DC input cable. Connect the solar panels (in series or parallel) to AC500 and **CHECK** the PV connection on LCD screen.

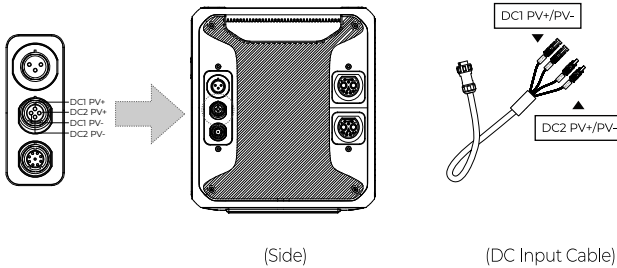

Note: Please make sure your solar panels at each input comply with:

OCV²: 12-150V Vmp³: 12-150V Power: 1500W Max.

E.g. Connect three BLUETTI PV350 solar panels in series to DC1/DC2.

BLUETTI PV350: Voc=46.5V Vmp=37.5V Current=9.2A Max.

Total: Voc=46.5×3=139.5V Vmp=37.5×3=112.5V Current=9.2A Max.

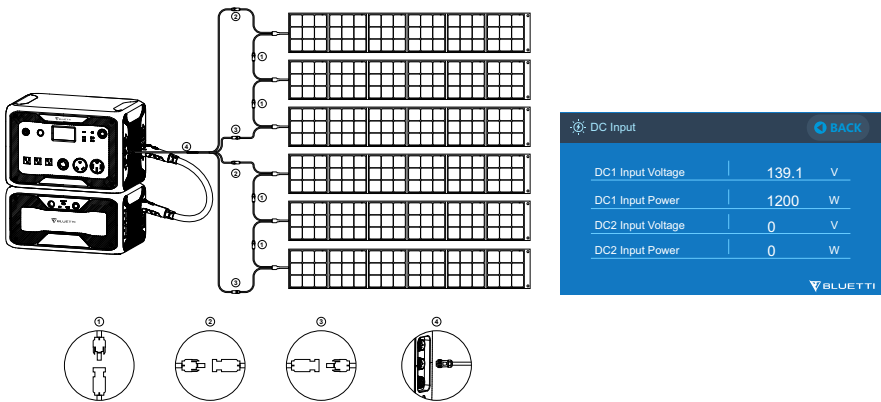

Roof panel can charge AC500. If the panel's OCV falls in 150-550V, use D300S to lower the voltage. Find details in D300S PV Voltage Step Down Module User Manual.

² OCV: Open circuit voltage, also for Voc. The maximum voltage that the solar panel can produce with no load on it.

³ Vmp: Voltage at maximum power. The voltage available when the panel is operating at its peak performance output.

Car Charging

Connect the AC500 to the vehicle plug-in cigarette lighter port via the DC input cable and car charging cable.

Note: Set the 'Others' as DC1/DC2 input source to enable car charging.

The Max. input current is 8.2A.

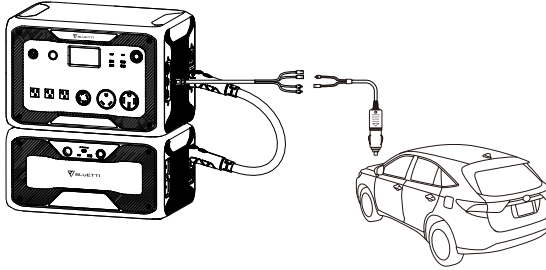

Lead-acid Battery Charging

Connect the AC500 to the vehicle plug-in cigarette lighter port via the DC input cable and lead-acid battery charging cable.

Note: Set the 'Others' as DC1/DC2 input source to enable lead-acid battery charging.

Clamp the positive connector (red) to the positive battery terminal and negative (black) to the other.

The Max. input current is 8.2A.

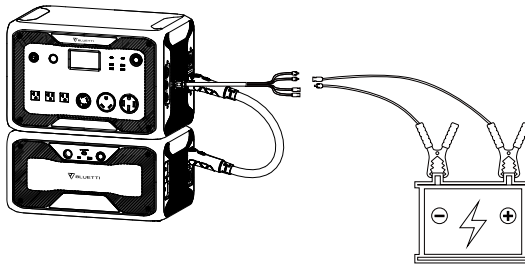

⁴ The lead-acid charging cable is for charging AC500 ONLY.

Dual Charging

Set the 'PV' as DC1/DC2 input source to enable AC/Generator + PV Charging.

Set the 'Others' as DC1/DC2 input source to enable AC/Generator + Adapter/Car/Lead-acid Battery Charging.

Turn on the 'PV Parallel Enable' to enable excessive PV charging (>1500W, <150V).

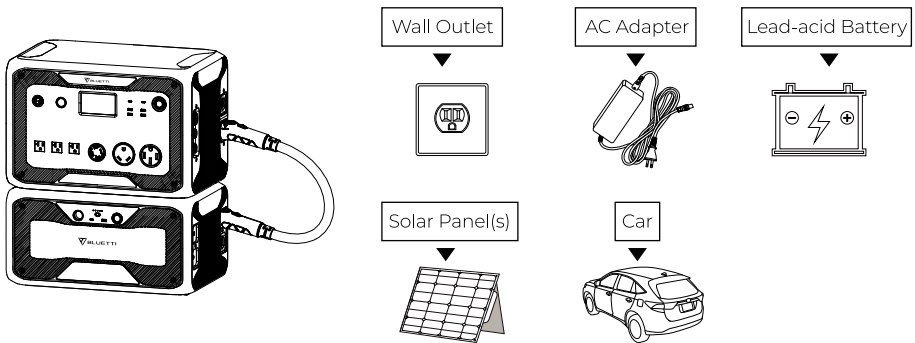

Discharging

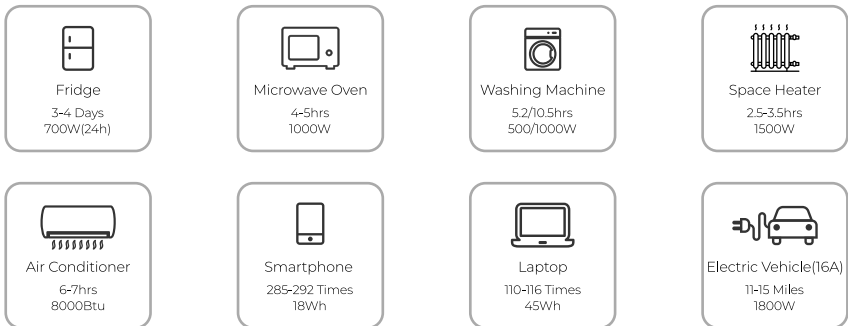

$6144Wh^* \times DoD \times \eta \div (\text{load power}) = \text{charging time (estimated)}$

* Take the AC500+2*B300S combo as an example.

Note: DoD refers to the Depth of Discharge, η is the local inverter efficiency. DoD=95%, η =90%.

DoD may vary depending on ambient-operating temperature and discharge rate.

Load power and charging time are measured in Watt and Hour.

Capacity Expansion

Connect the AC500 power station with B300S via the P150D battery expansion cable.

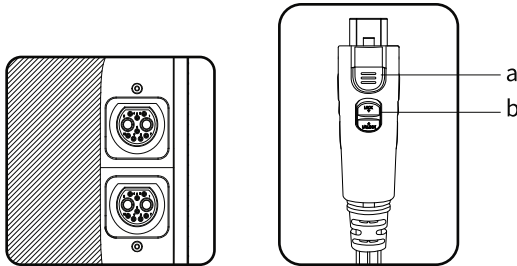

(P150D Battery Expansion Cable)

- a: Enable/disable the battery expansion function.
- b: Lock/unlock the connection.

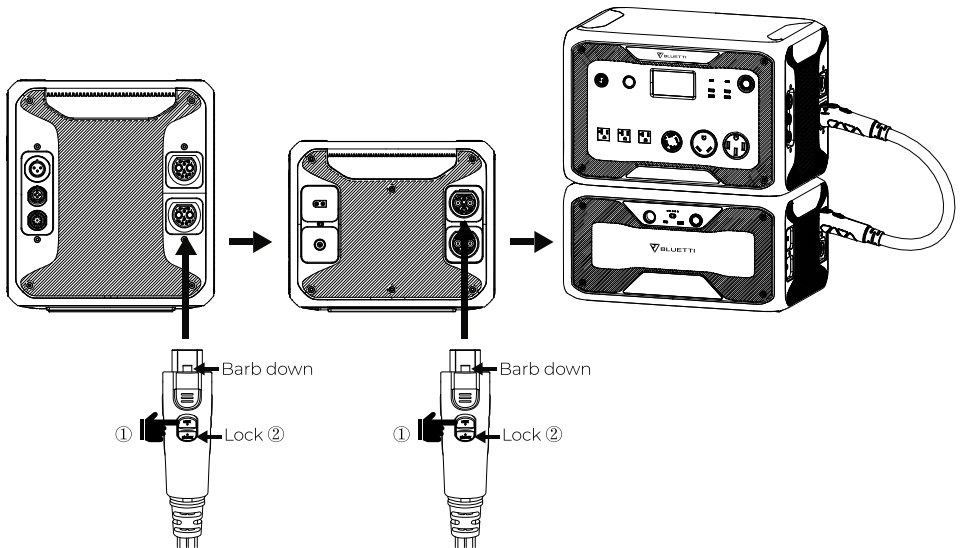

Note: Press either the power button on AC500 or B300S to turn on the AC500 + B300S combo. When AC500 is connected to power source, the AC500 + B300S combo turns on automatically. If there's only one B300S connected, the combo delivers a maximum output of 4500W. To get 5000W AC output, please connect at least one expansion battery to each expansion port.

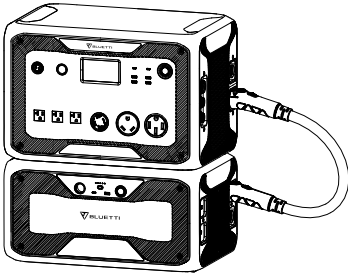

AC500 + 1*B300S = 4500W Max. / 3072Wh

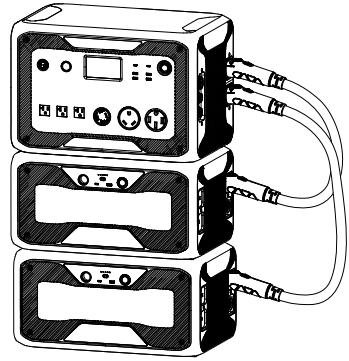

AC500 + 2*B300S = 5000W Max. / 6144Wh

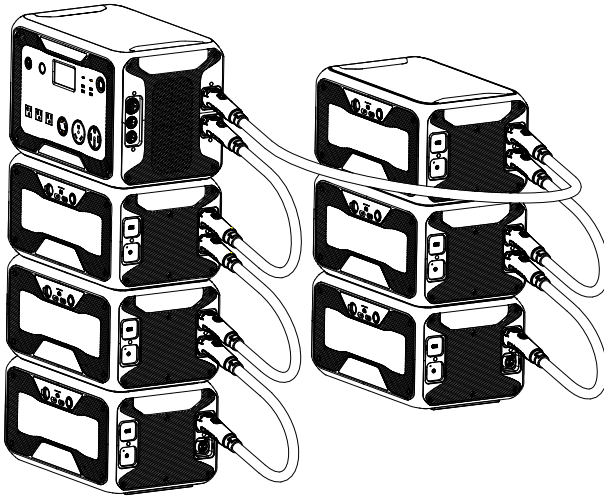

AC500 + 6*B300S = 5000W Max. / 18432Wh

B300S Capacity Expansion Tutorial

UPS

Tie the AC500 + B300S combo to the grid with the smart home panel.

Connect the critical loads to the AC output of AC500.

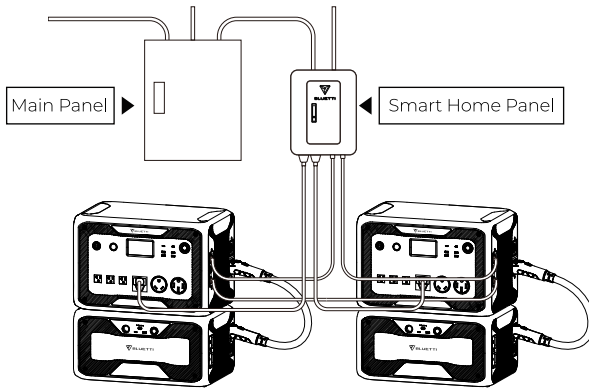

Standard UPS

The combo is set at standard UPS by default. The grid first charges the combo, followed by the devices on AC output ports. When the grid fails, the combo automatically steps in and powers the devices.

Time Control UPS

Set the 'Time Control UPS' as the working mode.

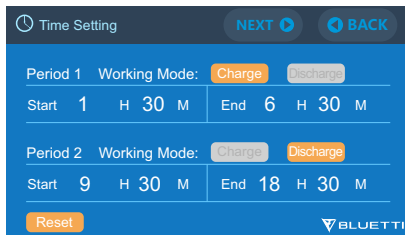

Charge Time: Select off-peak electricity consumption time to charge the combo by the grid.

Discharge Time: Select the time to power the loads connected to the smart home panel.

Battery SOC Low: When power level drops to this SOC, the combo stops powering loads automatically.

Battery SOC High: The combo charges to this SOC from the grid, then from other power sources.

PV Priority UPS

Set the 'PV Priority UPS' as the working mode.

When battery SOC is higher than set value, devices on AC outlets are powered by grid and the combo together.

When battery SOC is lower, the grid charges the combo and devices at the same time.

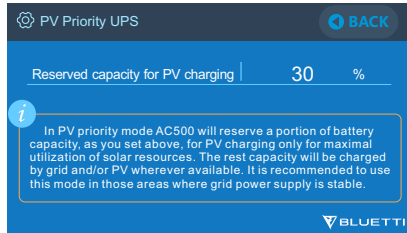

Reserved capacity for PV charging: The combo charges to this SOC from the grid, then from solar panels ONLY.

Customized UPS

Set the 'Customized UPS' as the working mode.

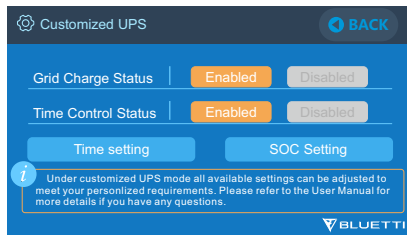

Grid Charge Status: By enabling this, the combo can charge from the grid and keep the grid settings.

Time Control Status: By enabling this, the combo can keep the settings of charging and discharging time.

Note: The settings of time and Battery SOC also take effect on Time Control UPS and PV Priority UPS modes.

Power Lifting Mode

This mode can be enabled in BLUETTI App. When on this mode, the combo can power high drain pure resistive loads⁵ ($\leq 6000W$), while the rated output power remains 5000W.

Note: Make sure the combo disconnects the grid and the B300S doesn't overload.

The AC500 detects the resistance of devices and adjusts the output voltage automatically.

The mode fails when the voltage is below 70% of its rated.

BLUETTI APP

Download the BLUETTI App from App Store or Google Play.



WiFi Connection

(1) Press 'Login' and register BLUETTI account.

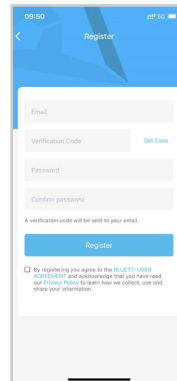
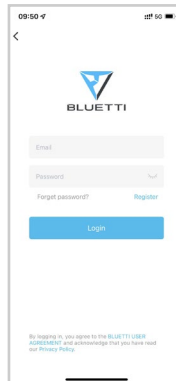
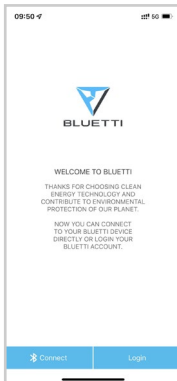

⁵ Includes heaters, irons or any other devices consisting of heating elements only.

(2) Scan the QR code on the unit and set the WiFi network.

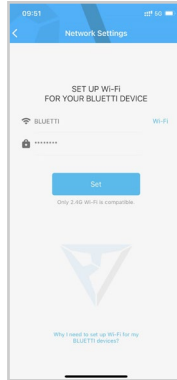
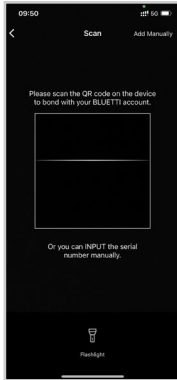

Note: The unit supports 2.4GHz WiFi ONLY.

Find the SN(Serial Number) on the unit or from the 'Product Info.'

If the WiFi connection fails, go to Settings(on your phone), tap BLUETTI and allow the network.

Bluetooth Connection

Press the '🔗 Connect' and pair with the unit.

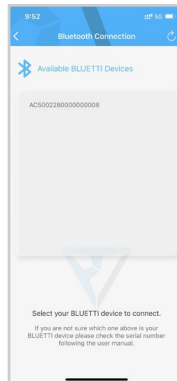
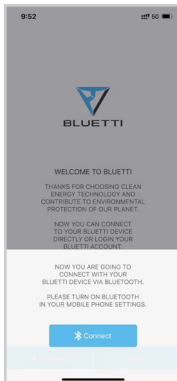

Note: For better IOT experience, please register the unit with WiFi.

Press '⚙️' to customize the settings.

The unit supports over-the-air (OTA) firmware upgrades.

Keep your phone no more than 16.4ft/5m away from the unit during the upgrade.

Split Phase System

Connect two AC500 together with the P030A split phase fusion box and communication cable.

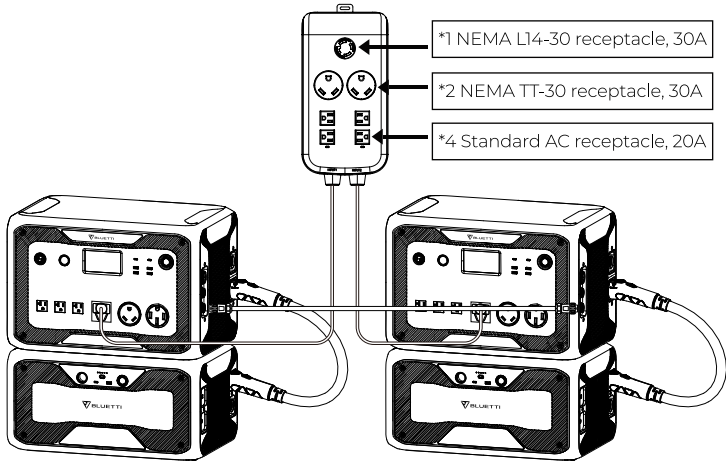

Go to 'Advanced Setting', tap 'Next' and set both AC500 to 'split phase'.

Choose one to be the 'Master' unit, the other 'Slave'.

If the connection fails, clear the alarm history and reconnect.

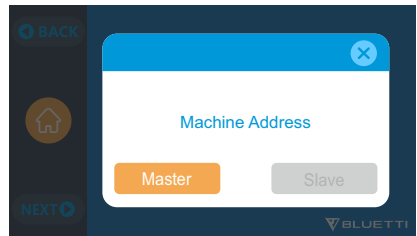
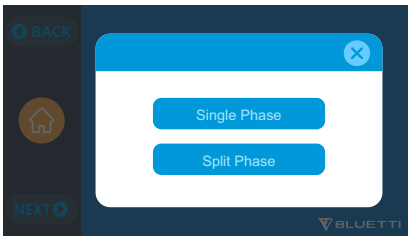

Note: The system can be turned on/off ONLY on the 'Master' unit.

WARNING: With the split phase P030A fusion box, the output power of both 'Master' and 'Slave' units can be set to a maximum of 3600W. Otherwise, it will cause damage to the EP500 and fusion box.

If you insist on charging AC500 in the system, ensure the sequence of L1, L2, and N wires* is correct.

* L1/L2: Line, 3-phase N: Neutral PE: Protective earth.

Appendix

FAQs (Frequently Asked Questions)

Q: Can I use third-party solar panels to charge this product?

A: Yes, you can. As long as the specs of solar panels on DC1/DC2 fall in below range:

OCV&Vmp: 12-150V

Input Power: 1500W Max.

With the same power connector (MC4)

DO NOT mix different types of solar panels.

Q: Why can't the unit be charged when the solar panels are connected?

A: Please follow below steps:

- 1) Press the 'PV' on LCD screen to check whether the solar panels are connected successfully.
- 2) Check the connection of solar panels and the PV input cable.

If the symptom persists, please contact BLUETTI service team.

Q: How to choose the right UPS mode for my home?

A: The standard UPS mode is good for regions with unstable grid power supply;

The Time Control UPS mode saves your electricity bills by setting the charging and discharging time.

The PV Priority UPS mode is better for regions with plenty of sunlight all the year.

The Customized UPS mode allows you to design your own power supply system.

Q: How long will it take to switch the UPS?

A: 20ms.

Q: How to upgrade the firmware?

A: Connect the unit with BLUETTI App, then you can over-the-air (OTA) upgrade the firmware including ARM, DSP, HMI, and BMS.

FCC Warning

This device complies with part 15 of the FCC Rules.

Operation is subject to the following two conditions:

- 1) This device may not cause harmful interference
- 2) This device must accept any interference received, including interference that may cause undesired operation.

This equipment has been tested and found to comply with the limits for a Class B digital device, pursuant to part 15 of the FCC Rules. These limits are designed to provide reasonable protection against harmful interference in a residential installation. This equipment generates, uses and can radiate radio frequency energy and, if not installed and used in accordance with the instructions, may cause harmful interference to radio communications. However, there is no guarantee that interference will not occur in a particular installation.

If this equipment does cause harmful interference to radio or television reception, which can be determined by turning the equipment off and on, the user is encouraged to try to correct the interference by one or more of the following measures:

- 1) Reorient or relocate the receiving antenna.
- 2) Increase the separation between the equipment and receiver.
- 3) Connect the equipment into an outlet on a circuit different from that to which the receiver is connected.
- 4) Consult the dealer or an experienced radio/TV technician for help.

FCC RF Radiation Exposure Statement

This equipment complies with FCC radiation exposure limits set forth for an uncontrolled environment. This equipment should be installed and operated with minimum distance 20cm between the radiator and your body. This transmitter must not be co-located or operating in conjunction with any other antenna or transmitter.

FCC Caution: Any changes or modifications not expressly approved by the party responsible for compliance could void the user's authority to operate this equipment.

Technical Support

Should you require any further assistance, please do not hesitate to contact BLUETTI service team.

BLUETTI POWER INC

Web: <https://www.bluettipower.com/>

Tel: 833-988-3663 / 702-463-4792

Mail: service@bluettipower.com

Add: 6185 S Valley View Blvd Ste D. Las Vegas, NV 89118.



