

# **VEVOR<sup>®</sup>**

## **TOUGH TOOLS, HALF PRICE**

Support and E-Warranty Certificate

<https://www.vevor.com/support>

## **CHICKEN COOP USER MANUAL**

We continue to be committed to offering tools at competitive prices. "Save Half", "Half Price", or any other similar expressions used by us only represent an estimate of savings you might benefit from buying certain tools with us compared to the major top brands and do not necessarily mean to cover all categories of tools offered by us. You are kindly reminded to verify carefully when placing an order with us if you are saving half in comparison with the top major brands.



# VEVOR®

*CHICKEN COOP*  
*Dome Roof(2m)*

**MODEL:Dome Roof(2m)**

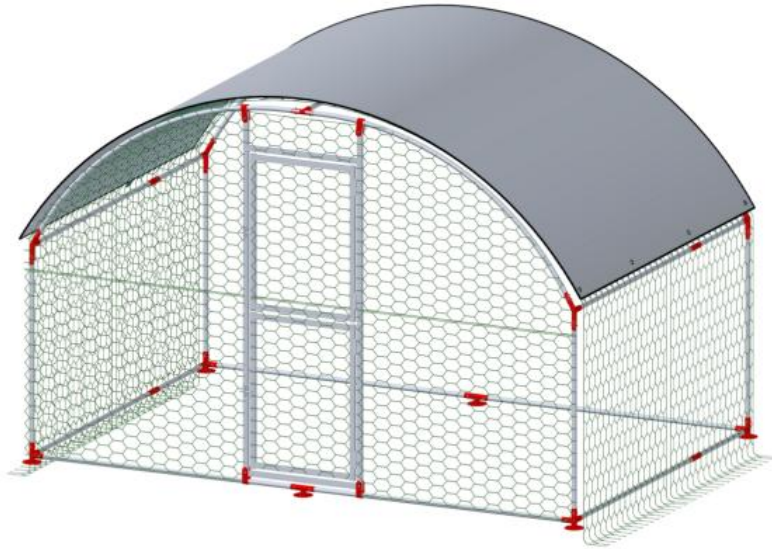

## **NEED HELP? CONTACT US!**

Have product questions? Need technical support? Please feel free to contact us:

 [\*\*CustomerService@vevor.com\*\*](mailto:CustomerService@vevor.com)

This is the original instruction, please read all manual instructions carefully before operating. VEVOR reserves a clear interpretation of our user manual. The appearance of the product shall be subject to the product you received. Please forgive us that we won't inform you again if there are any technology or software updates on our product.

## NOTES

1. The work may have burrs that injure the hands. Please wear gloves before installation.
2. Check whether the parts are complete before installation.
3. Please read this manual carefully before assembly.

-Tools supplied: 





-Tools required:  +  or 















-Assembly time: About 1-2 hours (with 2 people)







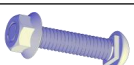





## MODEL AND PARAMETERS

Model	Dome Roof(2m)
Product Size	L200*W300*H200cm
Door frame	67.5*170cm
Protective net	Steel (Plastic impregnation), $\Phi 0.9\text{mm}$
Main frame	Galvanized steel pipe, $\Phi 25*0.8\text{mm}$

## ASSEMBLY

Mark	Picture	QTY
1	 1450mm	4
2A	 1500mm	5
2B	 450mm	5
3	 1050mm	4

4	 1730mm	4
D1		1
D2		1
D3		1
D4		1
D5		2
D6		2
D7		2
D8		4
DP1	 Lock	2
DP2	 M8	2
DP3	 Ø10x80	4
DP4	 M6	4
DP5	 M8x40	4
DP6	 U clips	4

C		5
D		4
E		4
F		0
G		2
H		0
J	Mesh(wide 1m)	1
K	 PVC lashing rope	1
L	 Plastic cable tie	1bag
M	 Tarpaulin	1
N	 Rubber cord	14
O	 Tent pegs	6
T		2

**Assemble the parts as shown below:**

**Step1:** Assemble 2A+C+2B into one piece (5 pieces in total)

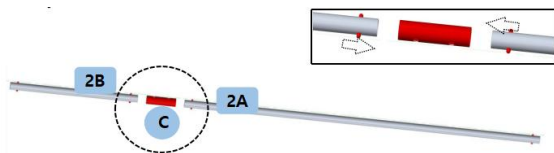

**Step2:** Install the bottom frame according to the part number in the picture below.

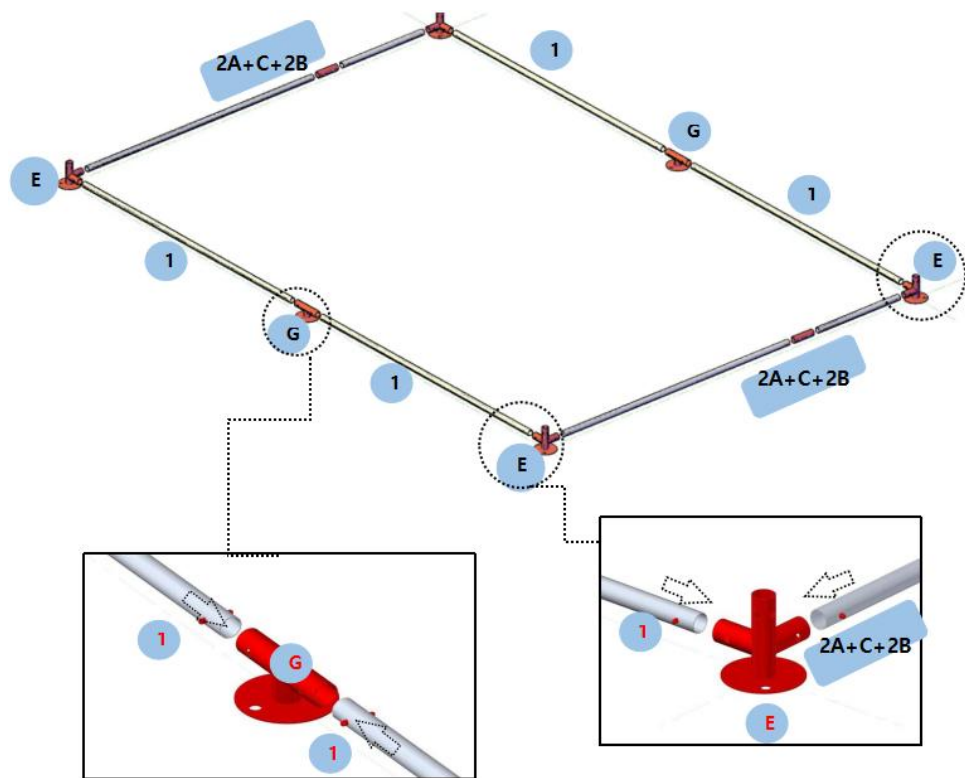

**Step3:** Install the column according to the part number below.

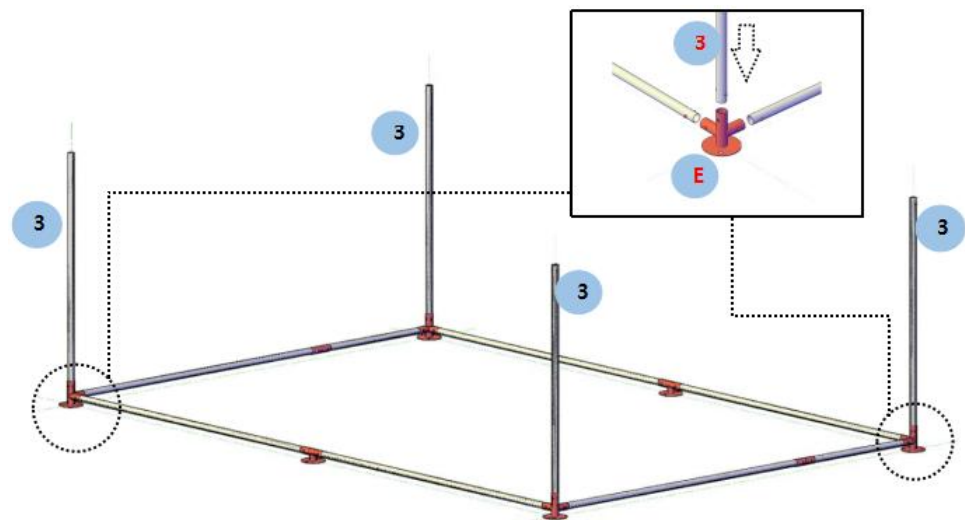

**Step4:** Install the beam according to the part number in the picture below.

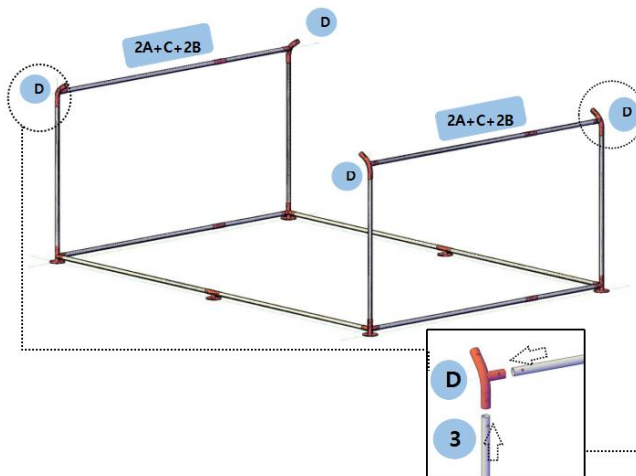

**Step5:** Install the top surface according to the part number in the figure below.

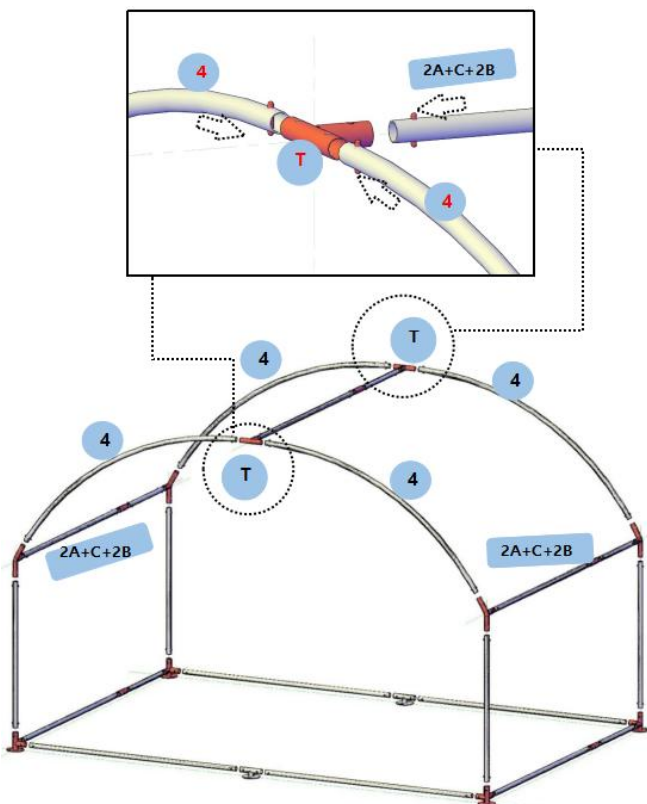



**Step6:** Install the door according to the part number below.

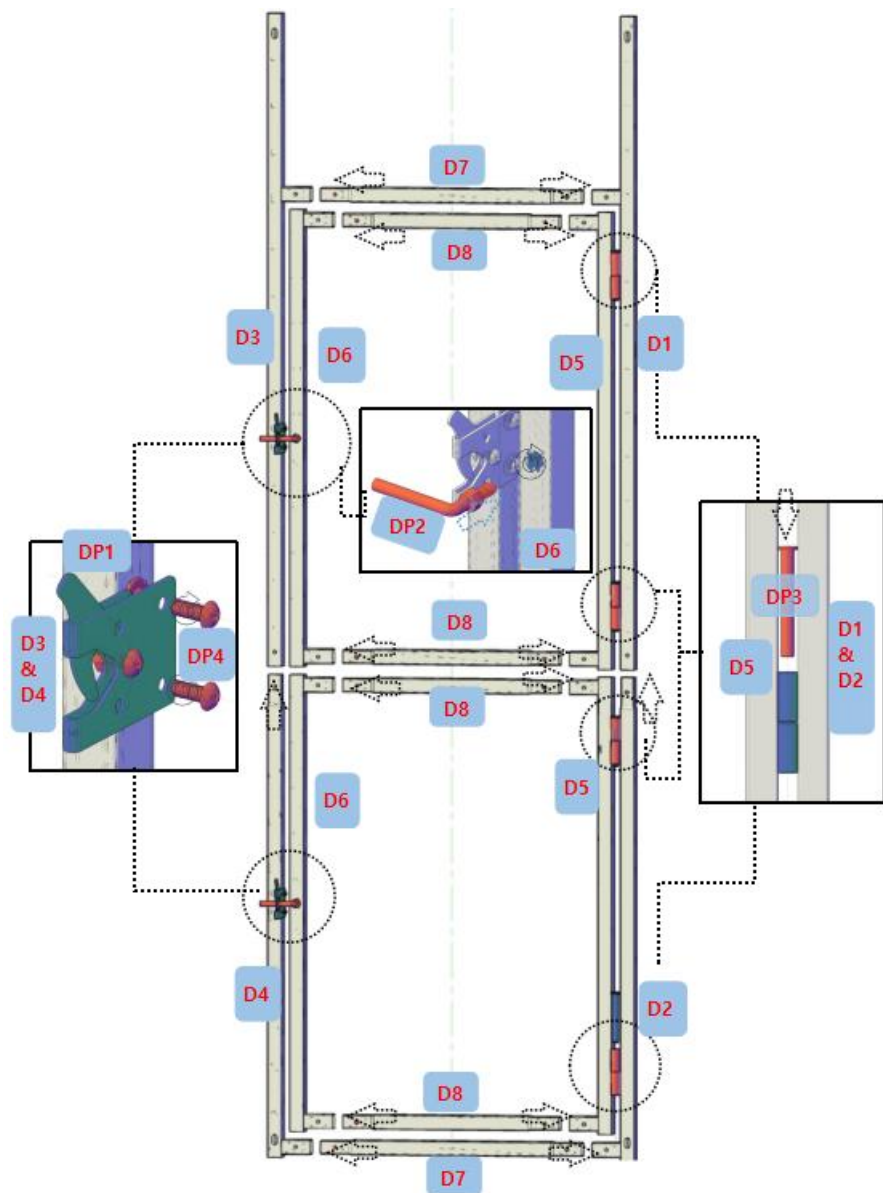

**Step7:** Attach the door to the frame.

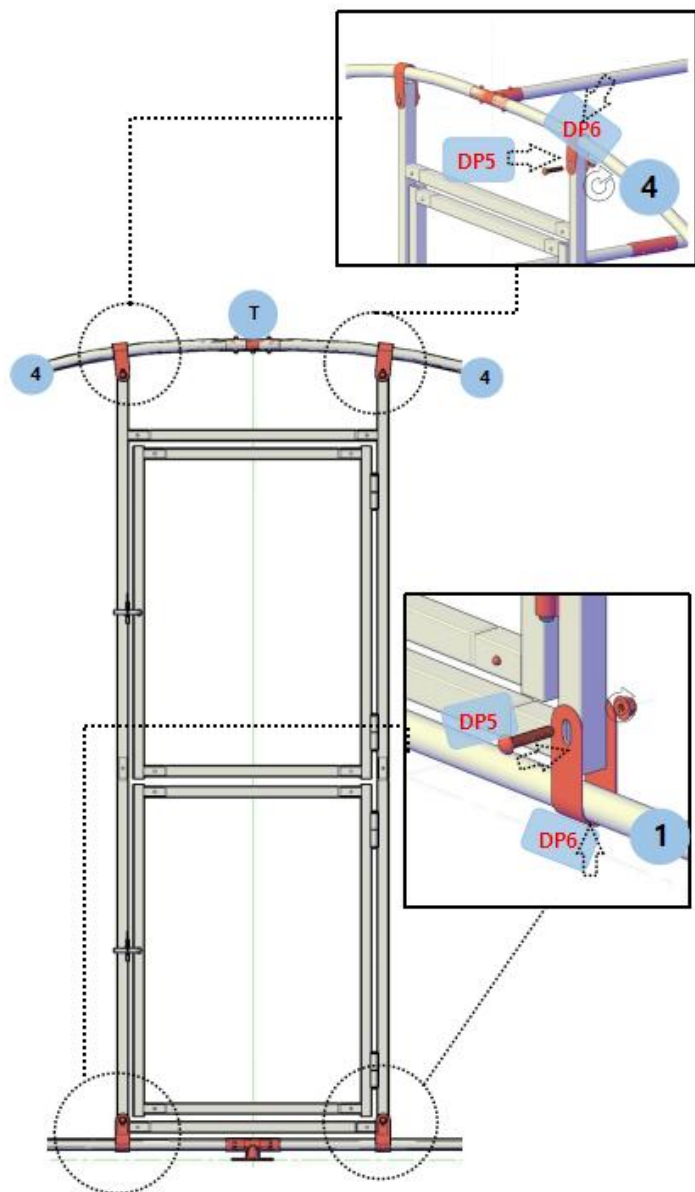

**Step8:** Installation of top mesh. The laying mesh can be pre-cut to 6.2x1m.

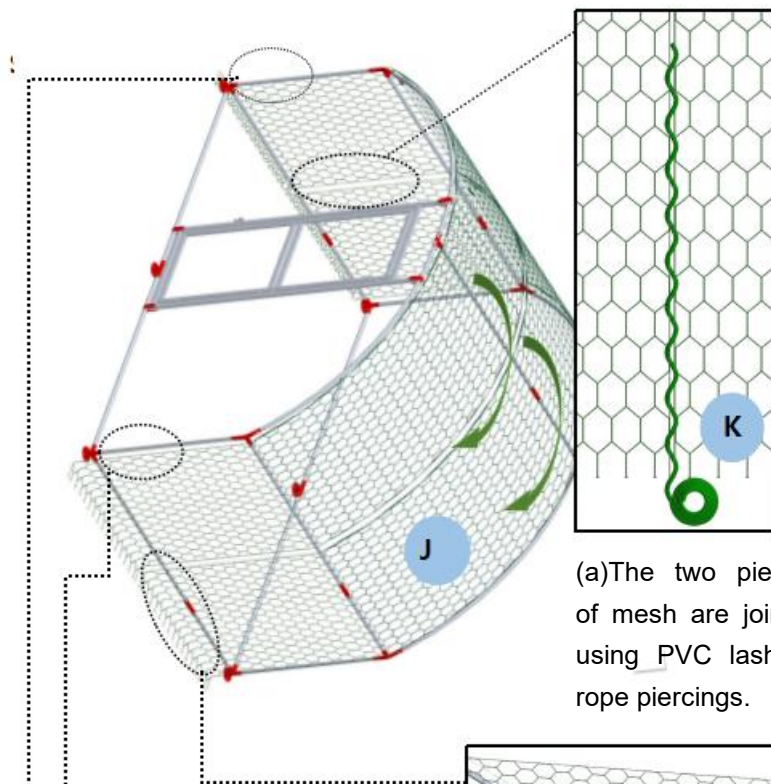

(a) The two pieces of mesh are joined using PVC lashing rope piercings.

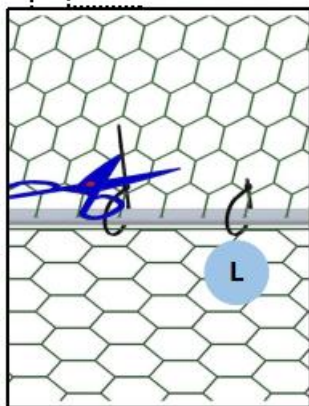

(c) Secure the mesh to the frame with cable ties. Cut off the excess length of cable ties.

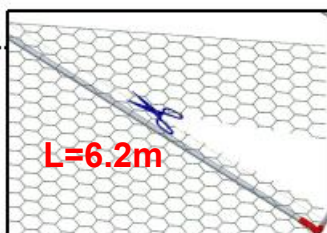

(b) Cut off the excess length of mesh if necessary. Extra mesh can be buried in the soil.

**Step9:** Install front and rear mesh (The two mesh are interlaced with PVC lashing rope) and secure to the frame with excess length cut.

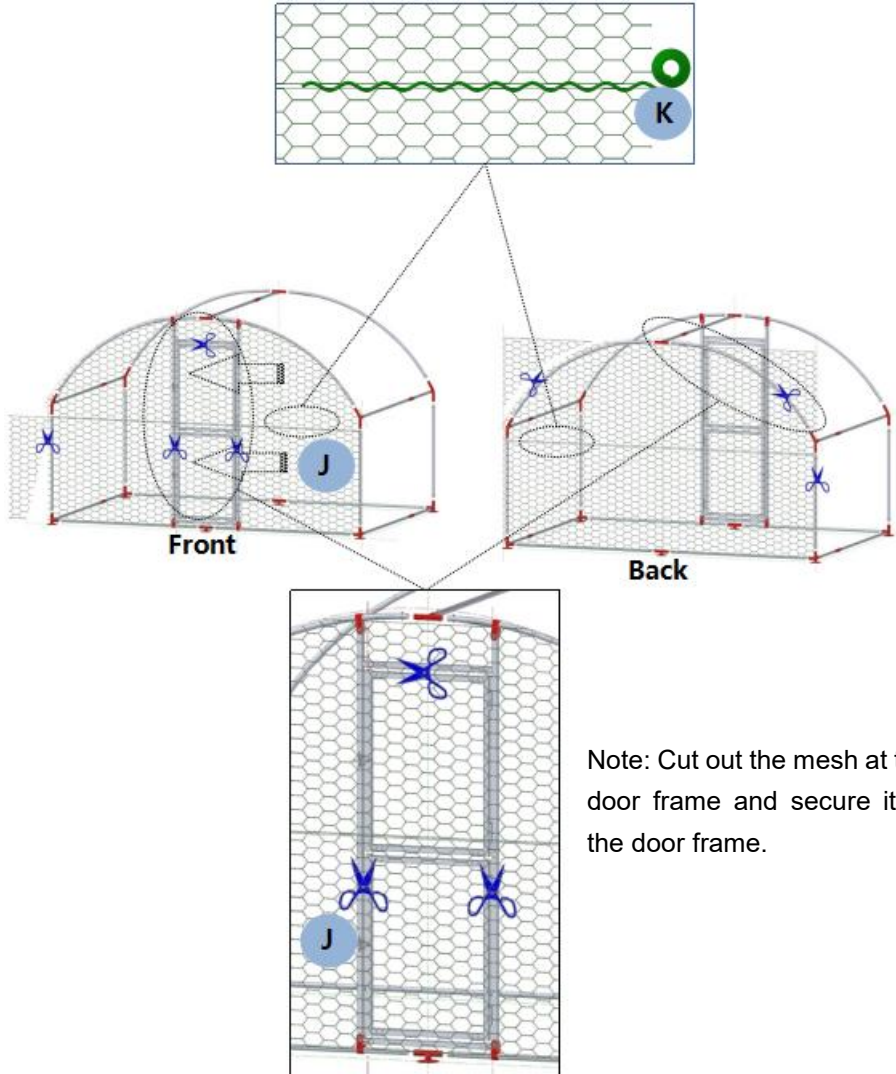

Note: Cut out the mesh at the door frame and secure it to the door frame.

**Step10:** Lay the tarp over the top and secure it with rubber cords.  
Secure the chicken coop to the floor with tent pegs.

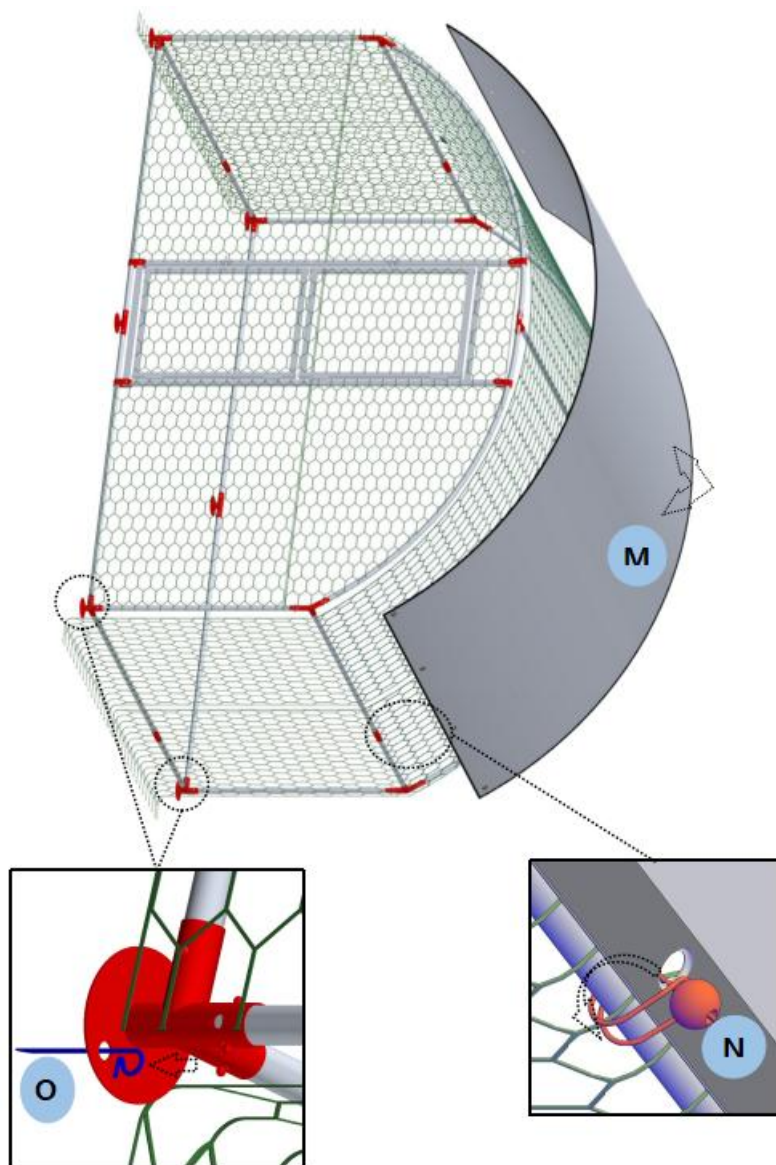

**Manufacturer:** HEBEI HABIT METAL PRODUCTS CO.,LTD

**ADD:** 9# Daocheng Logistics Park, Hengshui High-tech Zone, Hebei

**Made in China**

**Importer:** WAITCHX

**Address:** 250 bis boulevard Saint-Germain 75007 Paris

**Importer:** FREE MOOD LTD

**Address:** 2 Holywell Lane, London, England, EC2A 3ET



EUREP UK LTD

UNIT 2264, 100 OCK STREET, ABINGDON

OXFORDSHIRE ENGLAND OX14 5DH

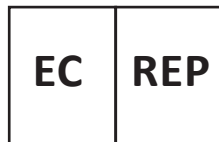

EUREP GmbH

Unterlettenweg 1a, 85051

Ingolstadt, Germany



**VEVOR<sup>®</sup>**

**TOUGH TOOLS, HALF PRICE**

Support and E-Warranty Certificate

<https://www.vevor.com/support>