

BRAVEPRO

OPERATORS

MANUAL



TAMPING RAMMER

BRPTR60H & BRPTR68H

Table of Contents

1. SAFETY INFORMATION.....	2
1.1 Safety Precautions.....	2
1.2 Operating Safety.....	3
1.3 Operator Safety while using Internal Combustion Engines.....	4
1.4 Service Safety.....	5
1.5 Label Locations.....	6
1.6 Safety Labels.....	7-8
1.7 Operating Labels.....	9
2. OPERATION.....	10
2.1 Application.....	10
2.2 Structure.....	10
2.3 Before Starting.....	10
2.4 To Start.....	11
2.5 Operation.....	12
2.6 To Stop.....	12
3. MAINTENANCE.....	13
3.1 Periodic Maintenance Schedule.....	13
3.2 Transporting.....	14
3.3 Spark Plug.....	14
3.4 Air Cleaner.....	15
3.5 Storage.....	15
3.6 Trouble Shooting.....	15-17
4. TECHNICAL DATA.....	18
WARRANTY.....	19
MAINTENANCE RECORD.....	20
EC DECLARATION.....	21

SAFETY INFORMATION

1.1 Safety Precautions

Before using this equipment, study the entire owner's manual to become familiar with its operation. Do not allow untrained or unauthorized personnel, especially children, to operate this equipment. Use only factory authorized parts for service.

This manual contains DANGER, WARNING, CAUTION callouts which must be followed to reduce the possibility of personal injury, damage to the equipment, or improper service.



This is the safety alert symbol. It is used to alert you to potential personal injury hazards. Obey all safety messages that follow this symbol to avoid possible injury or death.



DANGER

DANGER indicates a hazardous situation which, if not avoided, will result in death or serious injury.



WARNING

WARNING indicates a hazardous situation which, if not avoided, could result in death or serious injury.



CAUTION

CAUTION indicates a hazardous situation which, if not avoided, could result in minor or moderate injury.

1.2 Operating Safety

Familiarity and proper training are required for the safe operation of equipment! Equipment operated improperly or by untrained personnel can be dangerous! Read the operating instructions and familiarize yourself with the location and proper use of all instruments and controls. Inexperienced operators should receive instruction from someone familiar with the equipment before being allowed to operate the rammer.

- **NEVER** operate rammer in applications for which it is not intended.
- **NEVER** allow improperly trained personnel to operate rammer.
- **NEVER** touch hot muffler, engine cylinders, or cooling fins. Burns will result.
- **NEVER** use accessories or attachments which are not recommended by BravePro for rammer. Damage to rammer and/or injury to user may result.
- **NEVER** leave a running machine unattended.
- **NEVER** run machine indoors or in an enclosed area such as a deep trench unless adequate ventilation is provided. Exhaust gas from the engine contains poisonous carbon monoxide gas; exposure to carbon monoxide can cause loss of consciousness and may lead to death.
- **NEVER** tamper with or disable the function of operating controls.
- **NEVER** use choke to stop engine.
- **NEVER** operate the machine in areas where explosions may occur.
- **ALWAYS** remove or disconnect engine spark plug before servicing rammer, to avoid accidental start-up.
- **ALWAYS** read, understand, and follow procedures in Operation Manual before attempting to operate equipment.
- **ALWAYS** be sure that all other persons are at a safe distance from the rammer. Stop the machine if people step into the working area of the machine.
- **ALWAYS** be sure operator is familiar with proper safety precautions and operation techniques before using rammer.
- **ALWAYS** wear protective clothing when operating rammer. Wear goggles or safety glasses, hearing protection, and safety shoes.
- **ALWAYS** keep hands, feet, and loose clothing away from moving parts of rammer.
- **ALWAYS** use common sense and caution when operating rammer.
- **ALWAYS** be sure rammer will not tip over, roll slide, or fall when not being operated.
- **ALWAYS** turn engine OFF when rammer is not being operated.
- **ALWAYS** guide the rammer in such a way that the operator is not squeezed between the rammer and solid objects. Special care is required when working on uneven ground or when compacting coarse material. Make sure to stand firmly when operating the machine under such conditions.
- **ALWAYS** operate the rammer in such a way that there is no danger of it turning over or falling in, when working near the edges of breaks, pits, slopes, trenches and platforms.

SAFETY INFORMATION

1.3 Operator Safety while using Internal Combustion Engines

- DO NOT smoke when refueling the engine or during any other fuel handling operation.
- DO NOT refuel a hot or running engine.
- DO NOT refuel the engine near an open flame.
- DO NOT spill fuel when refueling the engine.
- DO NOT smoke while operating rammer.
- DO NOT operate rammer near open flames.
- ALWAYS refill fuel tank in well-ventilated area.
- ALWAYS replace fuel tank cap after refueling.
- ALWAYS check fuel lines, fuel cap, and fuel tank for leaks and cracks before starting engine. Do not run machine if fuel leaks are present, or fuel cap or fuel lines are loose.
- If fuel is spilled during refueling, wipe it off from the engine immediately and discard the rag in a safe place. Do not operate the unit if fuel or oil leaks exist- repair immediately.
- NEVER operate this equipment in an explosive atmosphere.
- NEVER operate any gas powered equipment in a poorly ventilated or enclosed area.
- NEVER perform any work on the unit while it is running. Before working on it, stop the engine and disconnect the spark plug wire to prevent accidental starting.
- Avoid prolonged breathing of exhaust gases.
- Avoid contact with hot exhaust systems and engine parts.
- Allow engine to cool before performing any repairs or service.
- ALWAYS transport and handle fuel only when contained in approved safety containers.
- ALWAYS keep the area around the muffler free of debris such as leaves, paper, cartons, etc. A hot muffler could ignite the debris and start a fire.

SAFETY INFORMATION

1.4 Service Safety

Poorly maintained equipment can become a safety hazard! In order for the equipment to operate safely and properly over a long period of time, periodic maintenance and occasional repairs are necessary.

- DO NOT attempt to clean or service rammer while it is running.
- DO NOT operate rammer with safety devices or guards removed or not in working order.
- DO NOT operate rammer without air cleaner.
- DO NOT remove air cleaner paper element, pre-cleaner, or air cleaner cover while operating rammer.
- DO NOT alter engine speeds. Run engine only at speeds specified in engine manual Section.
- ALWAYS replace safety devices and guards after repairs and maintenance.
- ALWAYS keep area around muffler free of debris in order to reduce the chance of an accidental fire.
- ALWAYS do Periodic Maintenance as recommended in Operation Manual.
- ALWAYS clean debris from engine cooling fins.
- ALWAYS replace worn or damaged components with spare parts designed and recommended by BravePro for servicing this rammer.

SAFETY INFORMATION



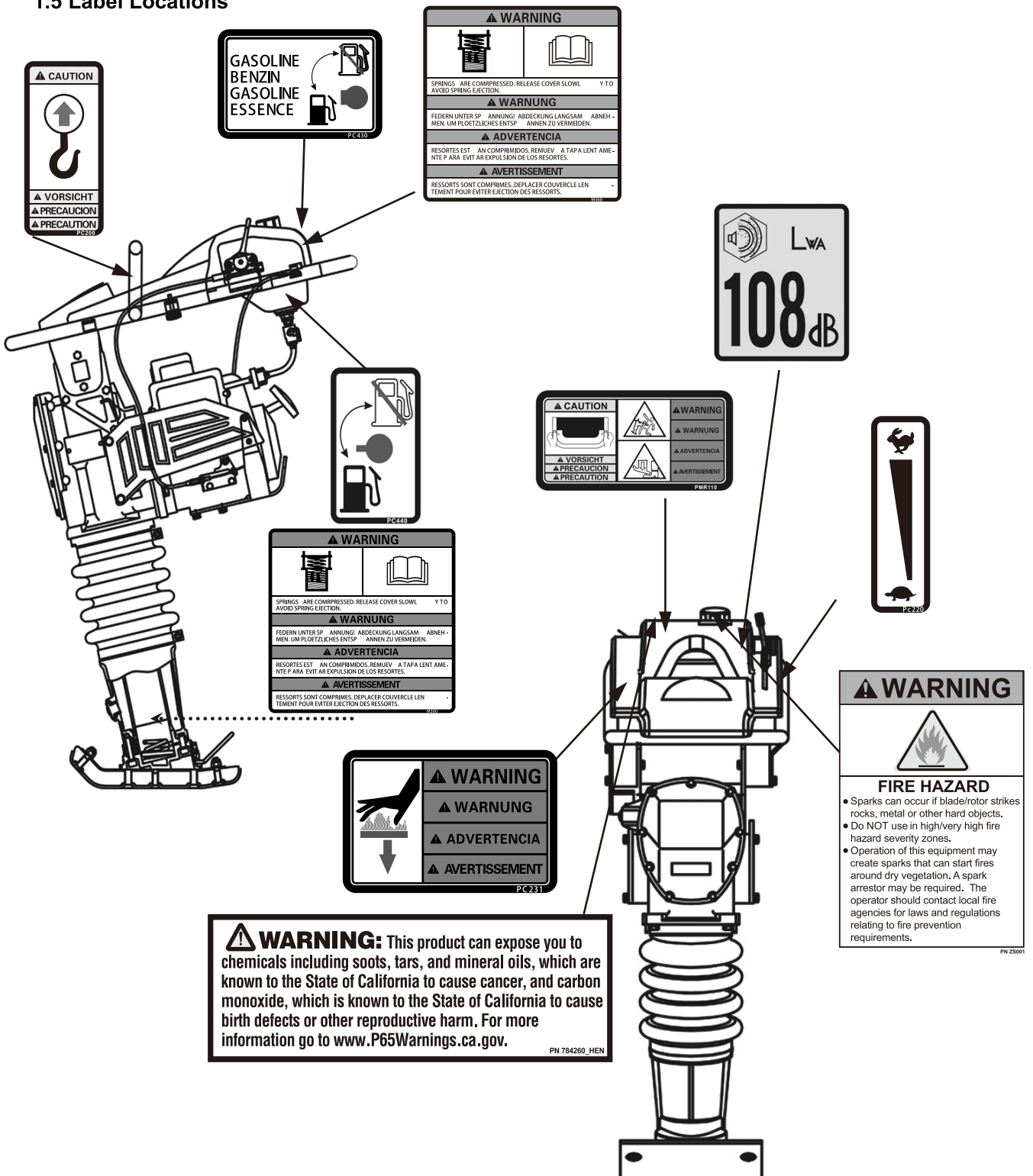

1.5 Label Locations





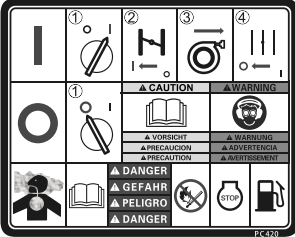



SAFETY INFORMATION

1.6 Safety Labels

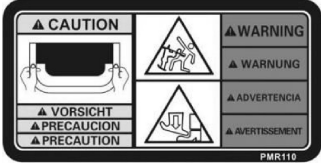
BravePro machines use international pictorial labels where needed. These labels are described below:

Label	Meaning
	<p>This model-in label contains important safety and operating information. If it becomes illegible, the cover must be replaced. Refer to the Parts Manual for ordering information.</p>
	<p>DANGER! Engines emit carbon monoxide; operate only in well-ventilate area. Read the Operation Manual for machine information. No sparks, flames, or burning objects near the machine. Shut off the engine before refueling. Use only clean, filtered unleaded gasoline.</p>
	<p>CAUTION! Lifting point.</p>
	<p>CAUTION! Use only clean, filtered gasoline fuel.</p>
	<p>WARNING! Hot surface!</p>



SAFETY INFORMATION

Label	Meaning
	<p>CAUTION!</p> <p>For optimal control, performance, and minimal hand/arm vibration, grasp handle as shown.</p>
	<p>WARNING!</p> <p>Serious injury if struck by compressed spring or cover. If the spring system cover is removed improperly, the springs can eject.</p>
	<p>Guaranteed sound power level in dB(A).</p>
	<p>A nameplate listing the model number and serial number is attached to each unit. Please record the information found on this plate so it will be available if the nameplate is lost or damaged. When requesting service information, the serial number should be specified of the unit.</p>
	<p>WARNING!</p> <p>Fire hazard.</p>
	<p>WARNING!</p> <p>Exposure hazard.</p>

SAFETY INFORMATION

1.7 Operating Labels

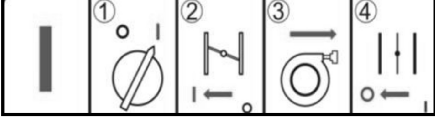
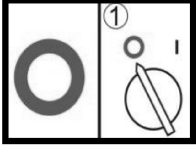
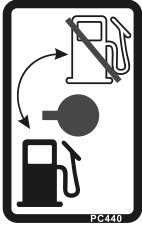
BravePro machines use international pictorial labels where needed. These labels are described below:

	<p>Start the engine:</p> <ol style="list-style-type: none"> ① Turn the engine switch to the ON position ② Close the choke. ③ Pull the rewind starter. ④ Open the choke.
	<p>Stop the engine: Turn the engine switch to STOP or "O" position.</p>
	<p>Fuel valve: Closed Open</p>
	<p>NOTICE! Throttle control lever: Turtle = Idle or Slow Rabbit = Full or Fast</p>

OPERATION

2 Operation

2.1 Application

Rammers are designed to compact loose soils and gravel to prevent settling and to provide a firm, solid base for the placement of footings, concrete slabs, foundations, gas piping works, water pipe works and cable backfill works, etc.



Please do not use in the following cases. It may cause damage because machine is likely to be unbalanced.

- Pile foundation
- Hard soil excessively compacted over normal condition
- Steep bank slope

Tamping Rammer is to be used for compacting cohesive clay, gravels, and patching work on asphalt, etc.

2.2 Structure

The upper part is made up of Power source, Clutch, Connecting Rod and Operating Handle, Fuel Tank that connected via Shock Absorbing Rubber to body. Bottom end is made up of Spring Cylinder (Sliding part), Foot Plate that ramps body, Foot and Bellows that covers sliding part.

2.3 Before Starting

- This machine has an oil bath lubrication system.
- Check the oil level through a window at rear end of the foot. Replenish oil if oil is not visible at the window. For lubrication, use automobile engine oil of 10W-30 SE, SF or better grade. Capacity is 830cc.
- Fill the fuel tank with regular gasoline. Simultaneously, check engine oil and make it a habit to replenish on the earlier side. Low lubrication oil level may result in engine seizure due to consumption during operation. Oil level should be checked prior to start up without fail. For lubrication, use automobile engine oil of 10W-30 SE, SF or better grade. See Engine Operating Manual for further detail.
- Check every bolt, nut or screwed area for tightness. ***Loosened due to vibration may result in unexpectedly serious trouble. Be sure to tighten any screwed area.***
- Remove dirt and dust. Particularly clean the vicinity of recoil starter and foot.

OPERATION

2.4 To Start

1. Open the fuel shut-off valve by moving the fuel lever to the open position.
2. Set the engine ON/OFF switch to the "ON" position.
3. Grip the recoil starter handle and pull it until you feel slight resistance. Then pull sharply and quickly. Return the recoil starter handle to the starter case before releasing.
4. If the engine has started, return the choke lever slowly to full-open position. Be sure to perform a warm-up run for the period 3 to 5 minutes at low speed, while paying careful attention to gas leakage or abnormal sound.
5. If it is difficult to start the engine by repeatedly pulling the starter rope, remove ignition plug and check the sparking performance. If the plug is wet due to excessive fuel intake or soiled, replace the plug or clean sufficiently. With the ignition plug removed, pull the recoil starter handle 2-3 times to discharge excessive blended gas.

OPERATION

2.5 Operation

1. Turn the choke lever to open the choke. Running the engine for 5 minutes at low speed to warm the engine.
2. Move the throttle level quickly to the "FULL OPEN" position. DO NOT move the throttle level slowly as this may cause damage to the clutch or spring.



CAUTION

Make sure that the throttle lever is moved to the FULL OPEN position. Operating the rammer at less than full speeds can result in damage to the clutch springs or foot.

3. After starting the tamping action, adjust the jumping motion to suit particular soil condition by lightly controlling the throttle lever. When the engine speed falls between the set values shown on the engine, your work can be carried out at the highest efficiency. Increasing the engine speed unnecessarily does not cause the compaction force to increase. On the contrary, the resulting resonance causes the compaction force to decrease, damaging the machine.
4. Under cold weather, the oil in the machine being viscous, resistance at reciprocating part is greater causing the tamping rammer to perform somewhat irregular movement. Therefore, it is recommended to perform warm-up run while moving the throttle lever repeatedly between ON and OFF positions, before entering the work.
5. Soil contacting surface of the foot is lined with heat-treated metal sheet for extra strength. However, for compacting cobblestone, use the filling-up soil for example so that the foot hits the soil uniformly.
6. The tamping rammer has been designed to advance while jumping. For quicker advance, erect the machine by pushing its handle down slightly so that flat surface of the foot at its rear-end contacts the ground.
7. To stop the tamping action, move throttle lever quickly from the FULL OPEN to IDLE position.

2.6 To Stop

2.6.1 Normal shutdown

1. With the throttle lever closed from ON to OFF, run the engine for 3-5 minutes at low speed, and after temperature is lowered, turn the switch to the "OFF" position.
2. Close the fuel shut-off valve by moving the fuel cock lever to the CLOSED position.

2.6.2 Emergency shutdown

Move the throttle lever quickly to the IDLE position, and turn the engine ON/OFF switch to the OFF position.

MAINTENANCE

3 MAINTENANCE

3.1 Periodic Maintenance Schedule

The chart below lists basic maintenance. Refer to engine manufacturer's Operator's Manual for additional information on engine maintenance. A copy of the engine Operator's Manual was supplied with the machine when it was shipped.

	Daily Before Starting	After First 5 hours	Every Week or 25 hours	Every month or 100 hours	Every 3 months or 300 hours
Check fuel level.	●				
Check oil level of machine.	●				
Check fuel line and fittings for cracks or leaks.	●				
Tighten ramming shoe hardware.		●	●		
Check and tighten engine cylinder screws.		●	●		
Check and tighten external hardware.		●	●		
Clean engine cooling fins.			●		
Clean and check spark plug gap.			●		
Replace spark plug.				●	
Clean recoil starter.					●
Change ramming system oil. *					●
Clean engine muffler and exhaust port.					●

* **Change ramming system oil after first 50 hours of operation.**

Note: If engine performance is poor, check, clean, and replace air filter elements as needed.

MAINTENANCE

3.2 Transporting

1. Shutdown engine for transportation.
2. For transportation, tighten fuel tank cap securely and close fuel shut off valve to prevent fuel from spilling.
3. Drain fuel for transportation over long distance or bad road.
4. Secure machine firmly to prevent it from moving or tipping.
5. Rammer should be transported in such position as it is placed on level ground. In case it must be laid down for transportation, drain fuel tank as well as carburetor and make sure that oil plug is tightened securely, then tie it to the vehicle at points (a) and (b).
6. Direction to lay down the rammer, must be such that air cleaner comes to top. After laying it, make sure that there is no leak of fuel from cap (c).
7. Make sure lifting device has enough capacity to hold machine (see identification plate on machine for weight). Use central lifting point (a) when lifting machine.
8. Use trolley kit (supplied as optional) for short distance transportation.

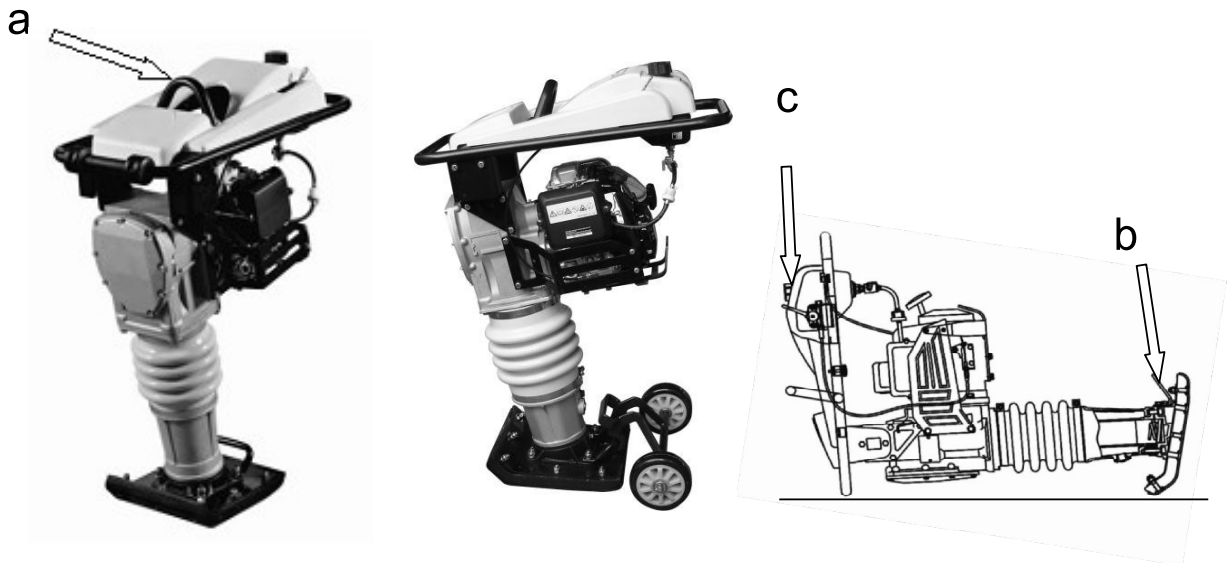

3.3 Spark Plug

Check and clean spark plugs regularly. A fouled, dirty spark plug may cause hard starting and poor engine performance. Set spark plug gap to recommended clearance. Refer to engine manual.



WARNING

The muffler and engine cylinder become very hot during operation and remain hot for a while after stopping the engine. Allow engine to cool before removing spark plug.

NOTICE: A loose spark plug can become very hot and may cause engine damage.

MAINTENANCE

3.4 Air Cleaner

Maintaining a clean engine will extend engine life. Keep air filter clean at all times. Clean air filter using the recommended solvent daily. See engine manual for proper cleaning procedure. Let the filter dry before reinstalling.



WARNING

NEVER use gasoline or other types of low flash point solvents for cleaning the air cleaner. A fire or explosion could result.

3.5 Storage

Rammer should be stored in such position as it is placed on level, after engine and machine have been cooled down. Be sure to secure the rammer as necessary to avoid falling down. If the rammer has to be laid down inevitably, tighten fuel tank cap and engine oil plug securely and wait until engine and machine are cooled down. After laying it down, make sure that there is no leak of fuel or oil. (If fuel leaks, drain the tank)

3.5.1 Long-Term Storage

- Drain fuel from fuel tank, fuel line and carburetor.
- Remove spark plug and pour a few drops of motor oil into cylinder. Crank engine 3 to 4 times so that oil reaches all internal parts.
- Clean exterior with a cloth soaked in clean oil.
- Store unit covered with plastic sheet in moisture free and dust free location out of direct sunlight.

3.6 Troubleshooting

3.6.1 Rammer Troubleshooting

SYMPTOM	POSSIBLE PROBLEM	SOLUTION
Engine rotates but amplitude not uniform or does not strike	Operating speed of throttle lever is incorrectly set?	Set throttle lever to correct position.
	Oil in excess?	Drain excess oil. Bring to correct level.
	Clutch slips?	Replace or adjust clutch.
	Spring Failure?	Replace spiral spring.
	Speed of engine improper?	Adjust engine speed to correct operating RPM setting.

MAINTENANCE

3.6.2 Engine Troubleshooting

SYMPTOM	POSSIBLE CAUSE	SOLUTION
Difficult to start		
Fuel is available but spark plug will not ignite.(Power available at high tension code.)	Ignition plug being bridging?	Check ignition system.
	Carbon deposit at ignition?	Clean or replace ignition.
	Short circuit due to deficient insulator?	Replace insulators.
	Improper spark gap?	Set spark plug gap to the correct gap.
Fuel is available but spark plug will not ignite.(Power NOT available at high tension code.)	Short circuit at stop switch?	Check stop switch circuit. Replace stop switch if defective.
	Ignition coil defective?	Replace ignition coil.
Fuel is available and spark plug ignites (compression normal).	Muffler clogged with carbon deposits?	Clean or replace muffler.
	Mixed fuel quality is inadequate?	Check fuel to oil mixture.
	Fuel in use inadequate (water, dust)?	Flush fuel system and replace with fresh fuel.
	Air cleaner clogged?	Clean or replace air cleaner.
	Defective cylinder head gasket?	Tighten cylinder head bolts or replace head gasket.
	Spark plug loose?	Tighten spark plug.

MAINTENANCE

SYMPTOM	POSSIBLE CAUSE	SOLUTION
Operation not satisfactory		
Not enough power available (compression normal, no misfiring)	Air cleaner clogged?	Clean or replace air cleaner.
	Air in fuel line?	Bleed (remove air) from fuel line.
	Fuel level in carburetor float chamber improper?	Adjust carburetor float.
	Carbon deposit in cylinder?	Clean or replace cylinder.
	Ignition coil defective?	Replace coil
	Ignition plug often shorts?	Replace ignition plug
	Fuel in use inadequate (water, dust)?	Flush fuel system and replace with fresh fuel.
Engine overheats.	Mixed fuel quality is inadequate?	Check fuel to oil mixture.
	Excessive carbon deposit in combustion chamber?	Clean chamber
	Exhaust or muffler clogged with carbon?	Clean or replace muffler.
	Spark plug heat value incorrect?	Replace spark plug with correct type spark plug.
Rotational speed fluctuates.	Governor adjustment improper?	Adjust governor to correct lever.
	Governor spring defective?	Replace governor spring
	Fuel flow erratic?	Check fuel line.
	Air taken in through suction line?	Check suction line.
Recoil starter not working properly.	Dust in rotating part?	Clean recoil starter assembly.
	Spiral spring failure?	Replace spiral spring.

TECHNICAL DATA

4. TECHNICAL DATA

Model	BRPTR60H	BRPTR68H
Engine type	Honda GX100	Honda GX100
Engine speed operating rpm	3800±100	3800±100
Power kw (hp)	2.2 (3.0)	2.2 (3.0)
Weight kg (lb)	60 (132)	68 (150)
Impact Force kN	10.7	12.8
Jumping stroke mm (in)	50-85 (2-3.4)	40-85 (1.6-3.4)
Fuel tank Capacity L	3.5	3.5
Shoe Size mm (in)	265x338 (10.4x13.3)	285x340 (11.2x13.4)
Ramming System Lubrication	0.8L, CD10W-30	

Working Size mm:

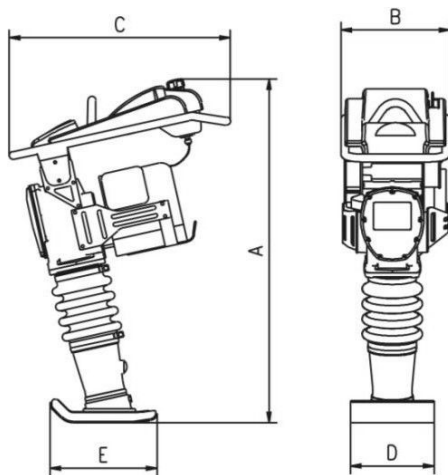

Model	A	B	C	D	E
BRPTR60H	1055	345	685	265	338
BRPTR68H	1055	410	705	285	340

Sound Specification (According to 2000/14/EC)

Measured sound Power level	105 dB(A)
Guaranteed sound power level	106 dB(A)
Sound power level limit	108 dB(A)

Hand-Arm vibration Specification (According to ISO 5394, EN 1033 and EN500-4):
6.8m/s²

WARRANTY



20195 South Diamond Lake Road, Suite 100 • Rogers, MN 55374
 Toll-Free: 800-350-8739 • Website: braveproducts.com • Email: sales@braveproducts.com

Dear Valued Customer:

The Brave product you just purchased is built with the finest material and craftsmanship. Use this product properly and enjoy the benefits from its high performance. By purchasing a Brave product, you show a desire for quality and durability. Like all mechanical equipment this unit requires a due amount of care. Treat this unit like the high-quality piece of machinery it is. Neglect and improper handling may impair its performance.

Thoroughly read the instructions and understand the operation before using your product. Always contact Brave Product Support at 1-800-350-8739 prior to having any service or warranty work performed, as some services performed by parties other than Brave approved service centers may void this warranty. This limited warranty is in lieu of any other warranty expressed or implied, written or oral and Brave assumes no other responsibility or liability outside that expressed within this limited warranty.

Limited Warranty for Brave Compaction Equipment:

BRPTR60H	BRPFP130H	BRPRP220H	BRPCS110H
BRPTR68H	BRPFP140H	BRPPT110H	BRPCS210H
BRPFP120H	BRPRP210H	BRPPT210H	

	Consumer Warranty Period	Commercial Warranty Period
Bellow on Rammer		
	5 years from date of purchase by user	5 years from date of purchase by user
Gear box on Rammer or Plate Compactor		
	3 years from date of purchase by user	3 years from date of purchase by user
Other Equipment Parts on Rammer, Plate Compactor, Roller, Floor Saw, Power Trowel and Vibrating Screed		
	2 years from date of purchase by user	2 years from date of purchase by user
Vibratory Poker or Submersible Pump		
	1 year from date of purchase by user	1 year from date of purchase by user
Engines	The engine warranty is covered under the terms and conditions as outlined by the engine manufactures warranty contained herein and is the sole responsibility of the engine manufacturer. Normal engine maintenance such as spark plugs, oil changes, air filters, adjustments, fuel system cleaning and obstruction due to build up is not covered by this Brave limited warranty.	
Warranty Limitations	<ul style="list-style-type: none"> • Wear items: 30 day limited warranty. Includes, but not limited to, all clutches. • Any condition resulting from other than ordinary wear or any use for which the equipment was not intended • Any condition resulting from incorrect or inadequate maintenance or care. • Damage resulting from misuse, abuse, negligence, accidents or shipping. 	

“Consumer use” means personal residential household use by a consumer. “Commercial use” means all other uses, including, but not limited to, use for commercial, income producing or rental purposes or when purchased by a business.

This limited warranty applies to the original purchaser of the equipment (verification of purchase, in the form of a receipt, is the responsibility of the buyer), is non-transferable, and covers parts and labor. Parts will be replaced or repaired at no charge, except when the equipment has failed due to lack of proper maintenance. If a part is no longer available, the part may be replaced with a similar part of equal function. Any misuse, abuse, alteration or improper installation or operations will void warranty. Determining whether a part is to be replaced or repaired is the sole decision of Brave. Brave will not provide for replacement of complete products due to defective parts. Any costs incurred due to replacement or repair of items outside of a Brave approved facility is the responsibility of the buyer and not covered under warranty. Transportation costs to and from service center and/or service calls are the responsibility of the customer.

This limited warranty specifically excludes the following: failure of parts due to damage caused by accident, fire, flood, windstorm, acts of God applications not approved by Brave in writing, corrosion caused by chemicals, use of replacement parts which do not conform to manufacturer specifications, damage related to rodent and/or insect infestation and damage caused by vandalism. Additional exclusions: loss of running time, inconvenience, loss of income, or loss of use, including any implied warranty of merchantability of fitness for a specific use. Also, outdoor power equipment needs periodic parts and service to perform well, and this limited warranty does not cover instances when normal use has exhausted the life of a component or the engine.

This limited warranty does not cover any personal injury or damage to surrounding property caused by failure of any part, misuse or inability to use the product. Alteration of the product, including safety features, shall void this limited warranty. Repair or replacement of parts does not extend the warranty period. This limited warranty gives you specific legal rights. You may also have other rights that vary by state. Please have model number, item number and serial number on hand prior to making a warranty claim or inquiry.

For products purchased on or after July 1, 2018

MAINTENANCE RECORD

PREVENTATIVE MAINTENANCE AND ROUTINE SERVICE PLAN

BravePro rammer has been assembled with care and will provide years of service. Preventative maintenance and routine service are essential to the long life of your rammer. After reading through this manual thoroughly, you will find that you can do some of the regular maintenance yourself. However, when in need of parts or major service, be sure to see your dealer. For your convenience we have provided this space to record relevant data about your rammer.

Invoice Number:		Type of Machine:	
Date Purchased:		Dealer Name:	
Serial Number:		Dealer Phone:	

REPLACEMENT PARTS USED					MAINTENANCE LOG	
PART NO.	DESCRIPTION	QTY	COST	DATE	DATE	OPERATION

**EC DECLARATION OF CONFORMITY
CE-KONFORMITÄTSERKLÄUNG
DECLARACIÓN DE CONFORMIDAD DE LA CE
DÉCLARATION DE CONFORMITÉ C.E.**

Brave Products

20195 South Diamond Lake Road, Suite 100 Rogers, MN 55374

hereby certifies that the construction equipment specified hereunder / bescheinigt, da. das Bauger.t / certifica que la máquina de construcción / atteste que le matériel :

1. Category / Art / Categoría / Catégorie:
Tamping Rammer
2. Type / Typ / Tipo / Type:
**BRPTR60H
BRPTR68H**

Has been sound tested per Directive 2000/14/EC/ In Übereinstimmung mit Richtlinie 2000/14/EG bewertet worden ist / Ha sido ensayado en conformidad con la norma 2000/14/CE/ A été mis à l'épreuve conforme aux dispositions de la directive 2000/14/CEE:

Conformity Assessment Procedure/ Konformitätsbewertungsverfahren/ Procedimiento para ensayar conformidad / Procédé pour l'épreuve de conformité	Name and address of notified body / Bei folgender einbezogener Prüfstelle / Oficina matriculadora / Organisme agréé	Measured sound power level / Gemessener Schalleistungspegel / Nivel de potencia acústica determinado / Niveau de puissance acoustique fixé	Guaranteed sound power level / Garantierter Schalleistungspegel / Nivel de potencia acústica garantizado / Niveau de puissance acoustique garanti
Annex VI / Anhang VI / Anex VI / Annexe VI	AV TECHNOLOGY AVTECH House, Arkle Avenue, Stanley Green Trading Estate Handforth, Cheshire, SK9 3RW, United Kingdom.	BRPTR60H/BRPTR68H with Gasoline Engine 105dB	BRPTR60H/BRPTR68H with Gasoline Engine 106dB

has been produced in accordance with the following standards:/in übereinstimmung mit folgenden Richtlinien hergestellt worden ist:/ha sido fabricado en conformidad con las siguientes normas: / a été produit conformément aux dispositions des directives européennes ci-après :

**2005/88/EC
2006/42/EC
2004/108/EC/EN55012:2007
EN500-1
EN500-4**



15.02.10

Hermann Josef Lensing
Research and Development Manager

Date / Datum / Fecha / Date

BRAVEPRO

Contact Us

Corporate Physical Address

Brave

A brand of Great Northern Equipment Distributing, Inc.

20195 South Diamond Lake Road, Suite 100

Rogers, MN 55374

Phone

800.350.8739

Website

www.braveproducts.com