

BRAVEPRO

OPERATORS MANUAL



WALK-BEHIND POWER TROWEL

BRPPT110H & BRPPT210H

Table of Contents

1. SAFETY INFORMATION

1.1 Safety Precautions	2
1.2 Operating Safety	3
1.3 Operator Safety while using Internal Combustion Engines.....	4
1.4 Label Locations.....	5
1.5 Safety and Operating Labels	6-7

2. OPERATION

2.1 Operating Principle	8
2.2 Application – Standard Feature	8
2.3 Delivery Checks	8
2.4 Before Starting	9
2.5 Assembly and Installation	9-10
2.6 To Start.....	10
2.7 To Stop.....	11
2.8 Initial Operation.....	11
2.9 Lifting the Trowel	11
2.10 Floating Operation.....	11
2.11 Finishing OperationI.....	12
2.12 Maneuver Operation.....	12

3. MAINTENANCE

3.1 Periodic Maintenance Schedule.....	13
3.2 Lubrication.....	13
3.3 Spark Plug.....	14
3.4 Air Cleaner	14
3.5 Lifting.....	14
3.6 Trouble Shooting.....	15-16

4. TECHNICAL DATA

17-18

5. WARRANTY

19

6. MAINTENANCE RECORD

20

7. EC DECLARATION

21

SAFETY INFORMATION

1.1 Safety Precautions

Before operating the machine, read both the manual and the engine manual carefully to become familiar with the location and proper use of all controls. Do not allow untrained or unauthorized personnel, especially children, to operate this machine. Use only the parts authorized by the factory for service.

This manual contains DANGER, WARNING, CAUTION callouts which must be followed to reduce the possibility of personal injury, damage to the equipment, or improper service.



This is the safety alert symbol. It is used to alert you to potential personal injury hazards. Obey all safety messages that follow this symbol to avoid possible injury or death.



DANGER

DANGER indicates a hazardous procedure which, if not avoided, will result in serious or mortal injury.



WARNING

WARNING indicates a danger or hazardous procedure which, if not avoided, could result in serious or mortal injury.



CAUTION

CAUTION indicates a danger or hazardous procedure which, if not avoided, could result in damage to machinery or moderate injury.

1.2 Operating Safety

- DO NOT modify the machine without the prior consent of the manufacturer. Brave does not assume responsibility for any accident due to equipment modification.
- NEVER operate the machine for a purpose for which it is not intended.
- NEVER allow anyone to operate the machine without proper training. People operating the machine must be familiar with the risks and hazards associated with it. And familiar with the safety precautions and operation techniques.
- ALWAYS operate the machine with all safety devices and guards in place and in working order.
- DO NOT wear loosely fitting clothing that might get caught in the machine.
- ALWAYS wear hearing and eye protection when operating the machine.
- DO NOT use the machine near flammable material or in explosive environments. The exhaust pipe can get very hot during operation. Sparks can be emitted from it, and these can ignite flammable material.
- ALWAYS keep the area around the muffler free of debris such as leaves, paper, carton, etc. A hot muffler could ignite the debris and start a fire.
- ALWAYS check that all controls are functioning properly immediately after start-up. DO NOT operate the machine unless all controls operate correctly.
- NEVER operate the machine with the fuel cap loose or missing.
- NEVER touch the engine, exhaust system of the machine. They are extremely hot during operation.
- DO NOT touch the V-belt and the rotating parts during operation.
- DO NOT clean or service the machine when it is running.
- NEVER use the defective parts.
- DO NOT remove blades when the machine is hanging overhead.
- ALWAYS keep the machine clean and labels clear.
- NEVER leave the machine running unattended.
- NEVER lift the machine by the handle only.

SAFETY INFORMATION





1.3 Operator Safety while using Internal Combustion Engines

- DO NOT smoke when refueling the engine or operating the machine.
- DO NOT refuel a hot or running engine.
- ALWAYS keep away from all hot or spark-generating objects when refuel the engine.
- ALWAYS refill the fuel tank after the machine has cooled, and in a well-ventilated environments.
- DO NOT spill fuel when refueling the engine.
- ALWAYS take care to use the right type of fuel.
- ALWAYS inspect the fuel leakage regularly.
- NEVER perform any work on the machine while it is running. Before working on it, stop the engine and disconnect the spark plug wire to prevent accidental starting.
- Avoid prolonged breathing of exhaust gases.
- ALWAYS transport and handle fuel only when contained in approved safety containers.
- NEVER touch or lean against hot exhaust pipes.
- Allow engine to cool before performing any repairs or service.
- ALWAYS keep the area around the muffler free of debris such as leaves, paper, cartons, etc. A hot muffler could ignite the debris and start a fire.
- NEVER run the engine without air filter.



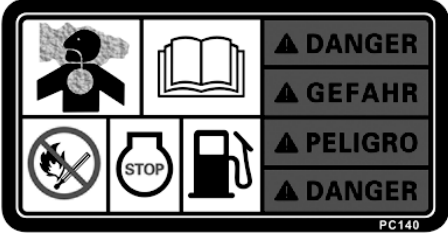
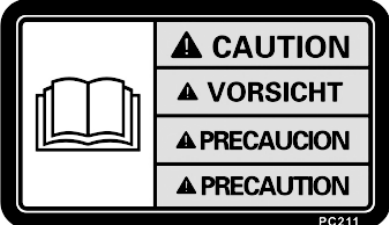

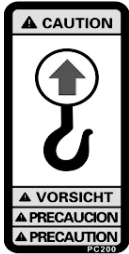
SAFETY INFORMATION

1.5 Safety and Operating Labels

BravePro machines use international pictorial labels where needed. These labels are described below:

Label	Meaning
	<p>DANGER! Engines emit carbon monoxide; operate only in well-ventilated area. Read the Operation Manual for machine information. No sparks, flames, or burning objects near the machine. Shut off the engine before refueling. Use only clean, filtered unleaded gasoline.</p>
	<p>CAUTION! Read and understand the supplied Operation Manual before operating the machine. Failure to do so increase the risk of injury to yourself or others.</p>
	<p>WARNING! Always wear hearing and eye protection when operating the machine.</p>
	<p>CAUTION! Lifting point.</p>
	<p>CAUTION! Use only clean, filtered fuel.</p>

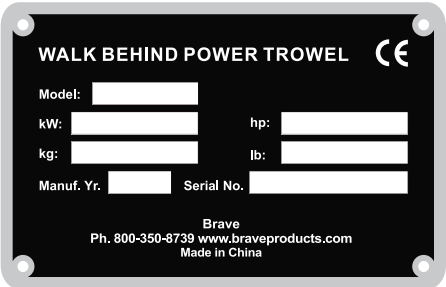
SAFETY INFORMATION

Label	Meaning
	<p>WARNING! Hot surface!</p>
	<p>WARNING! Hand injury if caught in moving belt. Always replace belt guard.</p>
	<p>WARNING! Cutting hazard. Always replace blade guard!</p>
	<p>A nameplate listing the model number and serial number is attached to each unit. Please record the information found on this plate so it will be available if the nameplate is lost or damaged. When requesting service information, the serial number should be specified of the unit.</p>
	<p>WARNING! Fire hazard.</p>
	<p>WARNING! Exposure hazard.</p>

OPERATION

2.1 Operating Principle

The following instructions were compiled to provide you information on how to obtain long and trouble free use of the machine. Periodic maintenance of the machine is essential. Read the manual carefully and thoroughly familiarize yourself with the machine and all its functions. Failure to do so may injure yourself or a bystander.

2.2 Application—Standard Features

Your new Power Trowel comes standard with many features to enhance productivity, performance and safety. Listed below are just a few of these features.

1. **Safe Stop Switch**—The switching mechanism of this switch should operate freely and should always be kept in this condition. The purpose of this switch is to stop the engine in a runaway situation, (i.e. the operator releasing the handle during operation). With the safety switch in the OFF position (hands free) the engine should not start or run. Only when operator squeezes (closes) switch handle to ON position will the engine run.
2. **Adjustable Throttle**—Located in a convenient location, this lever throttle control can be set to provide any blade speed from 50 to 130 RPM, and locked in place at the desired operating speed.
3. **Bent Arm Adjustable**—Allows blades to be adjusted to compensate for bent arms caused by dropping or mishandling the trowel. Can be easily adjusted on-site for consistent finishing.
4. **Heavy Duty Ring Guard**—Protects operator and unit while providing lower center of gravity which contributes to unit stability and performance.
5. **Cast Iron Spider**—Extra strong for insure alignment. Also contributes to lower center of gravity for increased trowel performance.
6. **Adjustable Handle**—Can be positioned to provide comfort and control for any operator's height.
7. **Tilt Adjustment Knob** – adjusts the angle of the blades for different curing stages and conditions of the concrete. Turning the knob clockwise increases the angle of the blades to the concrete. Turning the knob counter-clockwise flattens or decreases the angle of the blades.

2.3 Delivery Checks

Immediately on taking delivery of your new machine and before putting it into service;

- Read the operation manual completely—it could save a great deal of unnecessary expense.
- Read the engine manual supplied.
- Check the general condition of the machine – has it been damaged during delivery?
- Check engine oil level.
- Check fuel level.

Recommended lubricants are detailed in the engine manual.

OPERATION

2.4 Before Starting

Before starting the machine, check the following items:

- All handles are free from grease, oil and dirt.
- All bolted joints are tightened.
- Fuel level
- Oil level in the engine
- Condition of Ring Guard

NOTICE: Check the oil level in the engine and machine before starting. The warranties are VOID if the machine run without oil.

2.5 Assembly and Installation

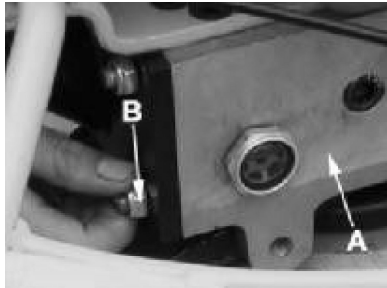

STEP 1: Un-pack the handle assembly and the lower unit from the boxes. Check to make sure no damage was done during shipment. Mount the handle assembly to the gearbox (A) on the lower unit using 10mm nuts (B) that are supplied in a package on the lower unit.

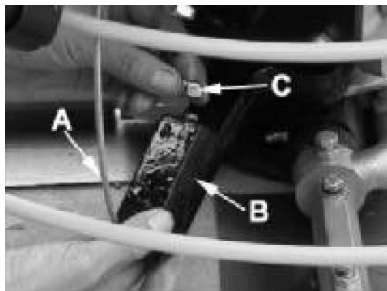

STEP 2: With the handle mounted to the lower unit, attach the pitch control cable (A) through the yoke arm (B) using the remaining 10mm nut (C). Tighten the nut.



STEP 3: Attach the kill wire that is coming from the handle assembly to the engine using the wire splicer that is supplied on the lower unit.

OPERATION

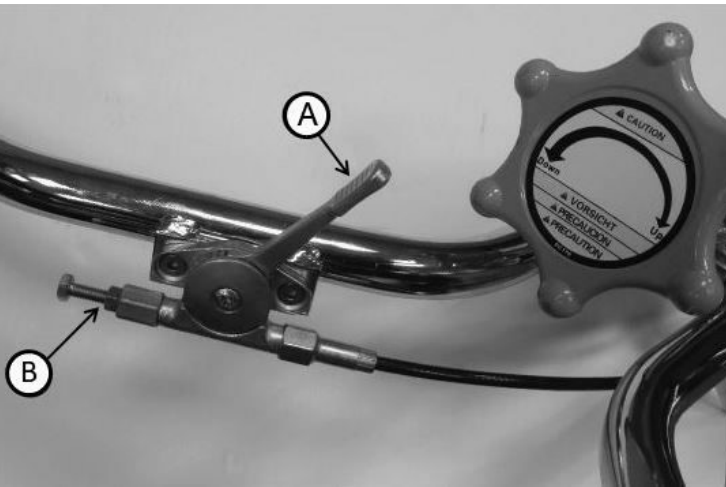

1. Adjust throttle lever (A) all the way forward (Fast) on handle.
2. No adjustment (B) is needed
3. Remove air cleaner cover and air cleaner filter – exposing throttle assembly
4. High speed adjustment screw (C) is set by the factory and should not be altered
5. Insert throttle cable tube through clamp (F) and tighten screw, once cable tube is all the way through.
6. Insert cable through small hole of cable holder (D) DO NOT TIGHTEN at this time.

7. While pulling and holding throttle lever (E) back towards handle (Fast), holding it securely against High speed screw (C) and making certain cable is tight, Tighten cable holder's set screw (D)

8. Replace air cleaner filter and cover assembly, make certain air filter seal/gasket is positioned correctly on filter base (G) when reinstalling air filter.

9. Test throttle lever on handle for free movement between slow and fast.

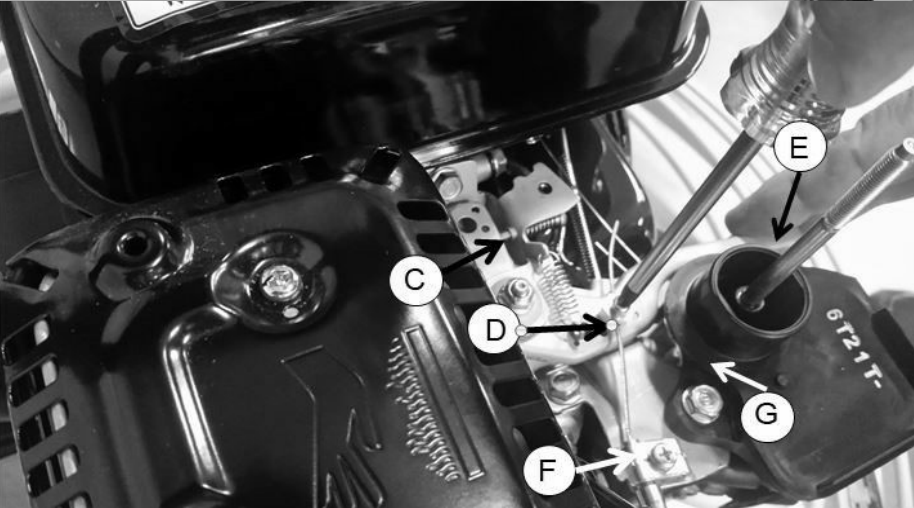

2.6 To Start

1. Open the fuel tap by moving the fuel ON/OFF lever fully to the right.
2. If starting the engine from cold, set the choke ON by moving the choke lever fully to the left. If restarting a warm engine, the choke is usually not required. However, if the engine has cooled to a degree, partial choke may be required.
3. Turn the engine ON/OFF switch clockwise to "1" position.
4. Set the throttle to the idle position by moving the throttle lever fully to the right. Do not start the engine on full throttle, as saw blade will begin to rotate as soon as the engine starts.
5. Taking a firm hold of the control handle with one hand, grasp the recoil starter handle with the other. Pull the recoil starter until engine resistance is felt, then let starter return.
6. Taking care not to pull the starter's rope fully out, pull the starter handle briskly.

OPERATION

7. Repeat until the engine fires.
8. Once the engine fires, gradually set the choke lever to the OFF position by moving it to the right.
9. If the engine fails to fire after several attempts, follow the troubleshooting guide on pages 15-16.

2.7 To Stop

1. Before stopping, let engine idle for a few minutes
2. Turn the fuel off.
3. Close the fuel valve.

2.8 Initial Operation

With engine started as instructed previously and at operating temperature, adjust speed to about half throttle. Hold the handle firmly with one hand and move the safety stop switch to run position to engage the trowel blades.

2.9 Lifting the Trowel

Remove the auxiliary lifting tube located on top of the main handle. Insert the tube into the socket located on the opposite side of the gearbox from the handle.

Make sure that the hole in the tube engages with the pin in the socket. With one person lifting from the main handle, and another lifting from the auxiliary lifting tube pick up the machine to move onto a slab.

2.10 Floating Operation

Attach float blades to the trowel arms, and when the concrete has set sufficiently to support the weight of the trowel, place the unit on the concrete. Start the unit and engage the blades as previously instructed. Using the tilt adjustment knob to adjust the blades to the float position-blades should be as flat to the concrete as possible with enough tension kept on the tilt adjustment cable to prevent the unit from dancing or chattering.

OPERATION

Guide the trowel over the concrete in a circular back and forth motion. Under normal conditions, you should be able to float a 30 x 30 foot area in approximately 15 minutes. This operation will bring the water and fines to the surface, allowing for a smoother finish when finishing the concrete.

2.11 Finishing Operation

After floating, allow the concrete to set until it will support the weight of the trowel. Set the pitch to approximately 1/4" to 3/8" on the blades. If the blades start to dig into the concrete, decrease the amount of pitch.

2.12 Maneuver Operation

Below (Figure 1) illustrates a typical walk-behind trowel application. Practice maneuvering the trowel. The trick is to let the trowel do the work.

Continue to practice maneuvering the trowel. Try to practice as if you were finishing a slab of concrete. Practice edging and covering a large area. Remember a good finishing technique is to work backwards. Be careful when moving backwards so that hazards can be avoided. The best way to get accustomed to the trowel is repeated use.

To move the trowel to the operator's left, **lift up** on the handle, to move the trowel to the right **push down** on the handle.

Remember! that if you let go of the trowel, just **step away** and let the trowel come to a complete **STOP** before trying to recover the trowel.

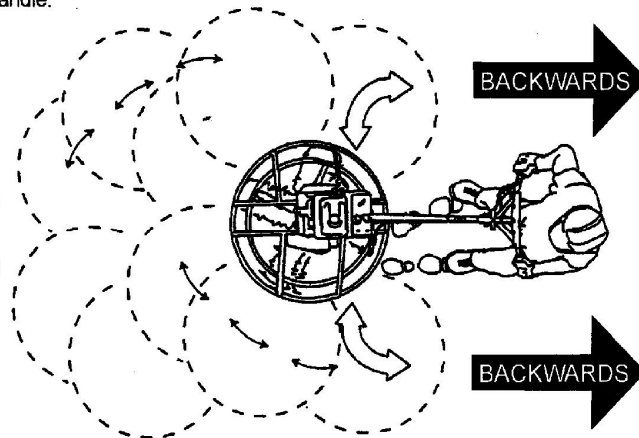

The best method for finishing concrete is to slowly walk **backwards** with the trowel, guiding the trowel from side to side. This will cover all footprints on wet concrete.

MAINTENANCE

3 MAINTENANCE

3.1 Periodic Maintenance Schedule

To get long use and free of trouble, it is essential to perform periodic maintenance on the engine and machine. A copy of the engine Operation Manual was supplied with the machine.

	Daily	Every 20 hours	Every 50 hours	Every 100 hours	Every 300 hours	Every 2000 hours
Check fuel level.	○					
Check engine oil level.	○					
Inspect air filter. Replace as needed.	○					
Clean trowel after each use to remove concrete splatter.	○					
Check external components	○					
Replace the engine oil		○				
Grease blade arms			○			
Clean air filter			○			
Thrust collar and clutch			○			
Replace blade if necessary						
Change the engine oil				○		
Check V-belt				○		
Clean spark plug				○		
Check and adjust valve clearance					○	
Remove, clean, reinstall clutch					○	
Check and replace the arm bushing, thrust collar bushing and shaft seal.						○
Check pitch control cable for wear						○
Adjust blade speed						○

3.2 Lubrication

The long life and successful operation of any parts of machinery is dependent on frequent and thorough lubrication. Before using the machine, always check the oil and use proper oil with the correct type and grade as recommended.

NOTICE: DO NOT mix types of oil in gearbox and DO NOT overfill the oil. Damage to the machine may occur if oils are mixed or overfilled. See Technical Data for oil quantity and type.

MAINTENANCE

3.3 Spark Plug

Check and clean spark plugs regularly. A fouled, dirty spark plug may cause hard starting and poor engine performance. Set spark plug gap to recommended clearance. Refer to engine manual.



WARNING

The muffler and engine cylinder become very hot during operation and remain hot for a while after stopping the engine. Allow engine to cool before removing spark plug.

NOTICE: A loose spark plug can become very hot and may cause engine damage.

3.4 Air Cleaner

Maintaining a clean engine will extend engine life. Keep air filter clean at all times. See engine manual for proper cleaning procedure.



WARNING

NEVER use gasoline or other types of low flash point solvents for cleaning the air cleaner. A fire or explosion could result.

3.5 Lifting

- Always shut off engine when transporting machine.
- Make sure lifting device has enough capacity to hold machine (see identification plate on machine for weight).
- Use lifting tube and lifting hook when lifting machine.



MAINTENANCE

3.6 Troubleshooting

SYMPTOM	POSSIBLE CAUSES	SOLUTION
Engine running rough or not at all.	Safety switch malfunction?	Make sure that the safety switch is ON or replace switch if necessary.
	Fuel?	Look at the fuel system. Make sure there is fuel being supplied to the engine. Check to ensure that the fuel filter is not clogged.
	Ignition?	Check to ensure that the ignition switch has power and is functioning correctly.
Safety switch not functioning.	Bad contacts?	Replace switch.
	Loose wire connections?	Check wiring. Replace as necessary.
	Other problems?	Consult engine manufacturer's manual.
If trowel "bounces, rolls concrete, or makes uneven swirls in concrete".	Blades? Spider?	Make certain blades are in good condition, not excessively worn. Finish blades should measure no less than 2" (50mm) from the blade bar to the trailing edge, combination blades should measure no less than 3.5" (89mm).
	Bent trowel arms?	Check that all blades are set at the same pitch angle as measured at the spider.
	Trowel arm bushings?	Check the spider assembly for bent trowel arms. If one of the arms is even slightly bent, replace it immediately.
	Thrust collar?	Check the trowel arm bushings for tightness. This can be done by moving the trowel arms up and down. If there is more than 1/8" (3.2mm) of travel at the tip of the arm, the bushings should be replaced. All bushings should be replaced at the same time.

MAINTENANCE

	Thrust collar bushing?	Check the thrust collar by rocking it on the spider. If it can tilt more than 3/32" (2.4mm) [as measured at the thrust collar O.D.], replace the bushing in the thrust collar.
	Thrust bearing worn?	Check the thrust bearing to see that it is spinning free. Note: Replace thrust cap, if necessary.
Machine has a perceptible rolling motion while running.	Main shaft?	The main output shaft of the gearbox assembly should be checked for straightness. The main shaft must run straight and cannot be more than 0.003" (0.08mm) out of round at the spider attachment point.
	Yoke?	Check to make sure that both fingers of the yoke press evenly on the wear cap. Replace yoke as necessary.
	Blade Pitch?	Check to ensure that each blade is adjusted to have the same pitch as all other blades. Adjust per maintenance section in manual.
Clutch slipping or sluggish response to engine speed change.	Worn V-belts?	Replace V-belt.
	Dirty centrifugal clutch?	Disassemble and clean clutch.
	Defective or worn out centrifugal clutch?	Replace entire clutch.
	Worn bearings in gearbox?	Rotate input shaft by hand. If shaft rotates with difficulty, check the input and output shaft bearings. Replace as necessary.
	Worn or broken gears in gearbox?	Verify that the gearbox shaft rotates when the input shaft is rotated. Replace both the worm and worm gear as a set.

TECHNICAL DATA

4. TECHNICAL DATA

BRPPT110H

Model	BRPPT110H
Engine type	Honda GX160
Power kw(hp)	4.0(5.5)
Operating Weight kg(lb)	81(179)
Blade Speed rpm	117-167
Rotor Dia. Cm(in)	91(36)
Finishing Blade	6"x14"
Combination Blade	8"x14"
Pan	37"

BRPPT120H

Model	BRPPT120H
Engine type	Honda GX270
Power kw(hp)	6.6(9.0)
Operating Weight kg(lb)	107(236)
Blade Speed rpm	117-167
Rotor Dia. Cm(in)	117(46)
Finishing Blade	6"x18"
Combination Blade	8"x18"

TECHNICAL DATA

Dimension:

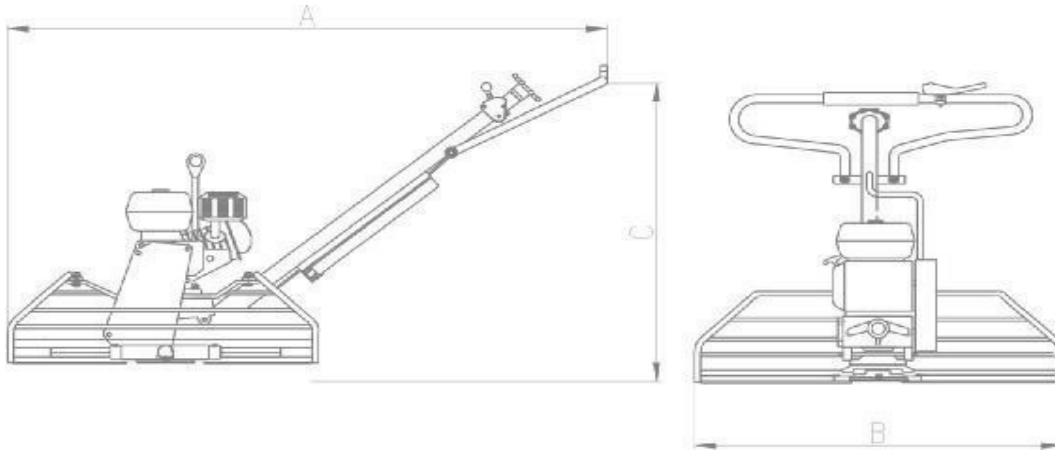

Model	A	B	C
BRPPT110H	1890MM	970MM	900MM
BRPPT120H	2060MM	1220MM	1000MM



20195 South Diamond Lake Road, Suite 100 • Rogers, MN 55374
 Toll-Free: 800-350-8739 • Website: braveproducts.com • Email: sales@braveproducts.com

Dear Valued Customer:

The Brave product you just purchased is built with the finest material and craftsmanship. Use this product properly and enjoy the benefits from its high performance. By purchasing a Brave product, you show a desire for quality and durability. Like all mechanical equipment this unit requires a due amount of care. Treat this unit like the high-quality piece of machinery it is. Neglect and improper handling may impair its performance.

Thoroughly read the instructions and understand the operation before using your product. Always contact Brave Product Support at 1-800-350-8739 prior to having any service or warranty work performed, as some services performed by parties other than Brave approved service centers may void this warranty. This limited warranty is in lieu of any other warranty expressed or implied, written or oral and Brave assumes no other responsibility or liability outside that expressed within this limited warranty.

Limited Warranty for Brave Compaction Equipment:

BRPTR60H
 BRPTR68H
 BRPFP120H

BRPFP130H
 BRPFP140H
 BRPRP210H

BRPRP220H
 BRPPT110H
 BRPPT210H

BRPCS110H
 BRPCS210H

	Consumer Warranty Period	Commercial Warranty Period
Bellow on Rammer		
	5 years from date of purchase by user	5 years from date of purchase by user
Gear box on Rammer or Plate Compactor		
	3 years from date of purchase by user	3 years from date of purchase by user
Other Equipment Parts on Rammer, Plate Compactor, Roller, Floor Saw, Power Trowel and Vibrating Sced		
	2 years from date of purchase by user	2 years from date of purchase by user
Vibratory Poker or Submersible Pump		
	1 year from date of purchase by user	1 year from date of purchase by user
Engines		
	The engine warranty is covered under the terms and conditions as outlined by the engine manufactures warranty contained herein and is the sole responsibility of the engine manufacturer. Normal engine maintenance such as spark plugs, oil changes, air filters, adjustments, fuel system cleaning and obstruction due to build up is not covered by this Brave limited warranty.	
Warranty Limitations		
	<ul style="list-style-type: none"> • Wear items: 30 day limited warranty. Includes, but not limited to, all clutches. • Any condition resulting from other than ordinary wear or any use for which the equipment was not intended • Any condition resulting from incorrect or inadequate maintenance or care. • Damage resulting from misuse, abuse, negligence, accidents or shipping. 	

“Consumer use” means personal residential household use by a consumer. “Commercial use” means all other uses, including, but not limited to, use for commercial, income producing or rental purposes or when purchased by a business.

This limited warranty applies to the original purchaser of the equipment (verification of purchase, in the form of a receipt, is the responsibility of the buyer), is non-transferable, and covers parts and labor. Parts will be replaced or repaired at no charge, except when the equipment has failed due to lack of proper maintenance. If a part is no longer available, the part may be replaced with a similar part of equal function. Any misuse, abuse, alteration or improper installation or operations will void warranty. Determining whether a part is to be replaced or repaired is the sole decision of Brave. Brave will not provide for replacement of complete products due to defective parts. Any costs incurred due to replacement or repair of items outside of a Brave approved facility is the responsibility of the buyer and not covered under warranty. Transportation costs to and from service center and/or service calls are the responsibility of the customer.

This limited warranty specifically excludes the following; failure of parts due to damage caused by accident, fire, flood, windstorm, acts of God applications not approved by Brave in writing, corrosion caused by chemicals, use of replacement parts which do not conform to manufacture specifications, damage related to rodent and/or insect infestation and damage caused by vandalism. Additional exclusions: loss of running time inconvenience, loss of income, or loss of use, including any implied warranty of merchantability of fitness for a specific use. Also, outdoor power equipment needs periodic parts and service to perform well, and this limited warranty does not cover instances when normal use has exhausted the life of a component or the engine.

This limited warranty does not cover any personal injury or damage to surrounding property caused by failure of any part, misuse or inability to use the product. Alteration of the product, including safety features, shall void this limited warranty. Repair or replacement of parts does not extend the warranty period. This limited warranty gives you specific legal rights. You may also have other rights that vary by state. Please have model number, item number and serial number on hand prior to making a warranty claim or inquiry.

For products purchased on or after July 1, 2018

**EC DECLARATION OF CONFORMITY
CE-KONFORMITÄTSERKLÄRUNG
DECLARACIÓN DE CONFORMIDAD DE LA CE
DÉCLARATION DE CONFORMITÉ C.E.**

**Brave Products
20195 South Diamond Lake Road, Suite 100 Rogers, MN 55374**

hereby certifies that the construction equipment specified hereunder / bescheinigt, da. das Baugerät / certifica que la máquina de construcción / atteste que le matériel :

1. Category / Art / Categoría / Catégorie:
Power Trowel

2. Type / Typ / Tipo / Type:
**BRPPT110H
BRPPT120H**

has been produced in accordance with the following standards:/in übereinstimmung mit folgenden Richtlinien hergestellt worden ist:/ha sido fabricado en conformidad con las siguientes normas: / a été produit conformément aux dispositions des directives européennes ci-après :

**2006/42/EC
2004/108/EC/EN55012:2007 (EMC)
EN12649**



15.02.10

Hermann Josef Lensing
Research and Development Manager

Date / Datum / Fecha / Date

BRAVEPRO

Contact Us

Corporate Physical Address

Brave

A brand of Great Northern Equipment Distributing, Inc.

20195 South Diamond Lake Road, Suite 100

Rogers, MN 55374

Phone

800.350.8739

Website

www.braveproducts.com

Version: 05/25/2018