

Potensic ATOM

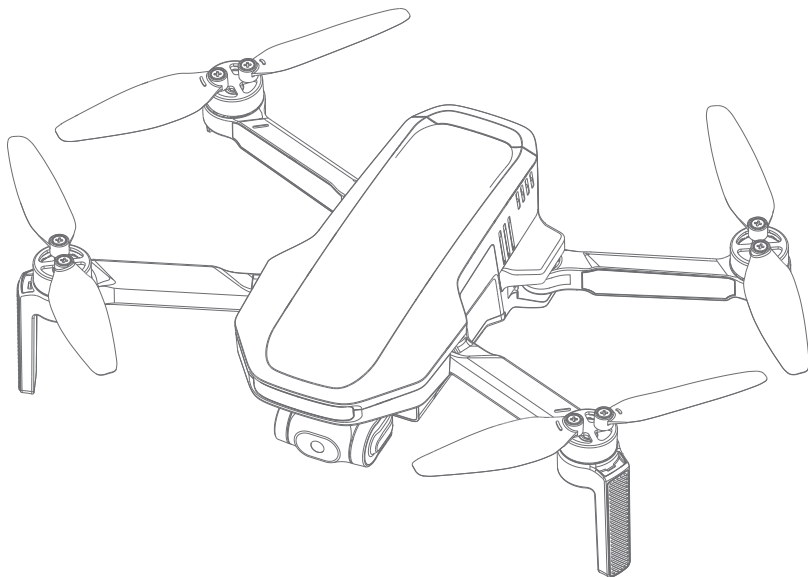

DANGER
Only suitable
for ages 14+



User Manual

V01. 23. 09

Email: support@potensic.com
Email: support.uk@potensic.com
Email: support.de@potensic.com

Email: support.fr@potensic.com
Email: support.it@potensic.com
Email: support.es@potensic.com

Email: support.jp@potensic.com
Web: www.potensic.com
FB: www.facebook.com/Potensic

Contents

1. Disclaimer & Precautions	02	6. PotensicPro App	19
1.1 Disclaimer	02	6.1 App Homepage	19
1.2 Safety & Precautions	02	6.2 Flight Interface	20
1.3 Warning & Prompts	02		
2. Reading Tips	03	7. Flight	24
2.1 Symbols	03	7.1 Requirements of Flight Environment	24
2.2 Suggestions of Use	03	7.2 Flight Precautions	24
2.3 Tutorial Video/Download App	03	7.3 Connection	24
2.4 Registration & Help	03	7.4 Flight Modes	24
2.5 Technical Terms	04	7.5 Beginner Mode	25
		7.6 Takeoff/Landing/Hovering	25
3. Overview	05	7.7 Intelligent Flight Modes	26
3.1 Introduction	05	7.8 Return(RTH)	30
3.2 Drone Diagram	05	7.9 Emergency Stop	31
3.3 Remote Controller Diagram	07		
3.4 Preparing the Drone	07	8. Calibration	31
3.5 Preparing the Remote Controller	06	8.1 Compass Calibration	31
3.6 Charging/Startup and Shutdown	08	8.2 Gimbal Calibration	32
		8.3 Gimbal Fine-Tuning	32
4. Drone	09	8.4 Remote Controller Calibration	33
4.1 Positioning	09	8.5 Drone Re-pairing	33
4.2 Downward Vision System	09		
4.3 Drone Status Indicator	10	9. Appendix	34
4.4 Smart Battery	11	9.1 Specification & Parameters	34
4.5 Propellers	13		
4.6 Flight Data	13		
4.7 Gimbal and Camera	14		
5. Remote Controller	15		
5.1 Overview	15		
5.2 Control Stick Mode	15		
5.3 Function	16		
5.4 Antenna Angle	18		

1. Disclaimer & Precautions

» 1.1 Disclaimer

Drones are products that are potentially dangerous and relatively complex to operate. Please be sure to read the full User Manual to ensure that you understand the basic knowledge of the drone and are familiar with the basic functions before using the product. It is recommended to use it in GPS mode in an open outdoor area for the first time to get familiar with the operation.

Please follow the Manual's operation instructions and precautions strictly, in order to use the product safely and correctly.

Users aged under 14 must be accompanied by an adult while using the product. Please keep the product out of children's reach.

For any direct or indirect loss (including but not limited to property loss and personal injury) due to user's failure in following the Manual's safety operation, the Company does not bear any liability or offer warranty services.

Do not dismantle any part except for propeller blades, or refit the product and attach other items on it; otherwise, user should undertake the consequences arising therefrom.

For any problem in use, handling and maintenance, please feel free to contact our local dealer or the Company.

Potensic reserves the final interpretation right of this document and related product documents, and is subject to change without notice. Please visit <https://www.potensic.com> for the latest information.

» 1.2 Safety & Precautions

Keep away from obstacles and crowds

Keep the product away from crowds, high-rise buildings and high-voltage cables, and avoid using it in severe weather such as wind, rain and thunder, in order to keep the safety of the user and the crowds, since the product may have uncertain flying speed, status and potential hazards.

Keep off moisture

Keep the product off moisture to avoid an anomaly or damage due to humidity of precise electronic components and mechanical parts inside it.

Safe operation

The product may be exposed to higher risk when user feels tired or lacks of energy and experience. Please refit or repair the product with the original parts to keep safety. Please operate and use the product within the allowed range and make sure to follow the local safety rules.

Keep away from high-speed revolving parts

While the product's propellers are revolving at a high speed, keep it away from the crowds and animals to avoid scratch or disturbance. Do not touch the spinning propellers with hands.

Keep away from heat source

Keep the product away from heat and high-temperature exposure to avoid the anomaly, deformation and even damage, because it is made of metal, fiber, plastic and electronic elements.

» 1.3 Warning & Prompts

01. Please read and understand the relevant tips included in the package.
02. User should avoid personal and property losses when using the product.
03. Neither the Company nor our dealers bear any liability for the proper losses and personal injuries due to users.
04. Debug and install the product in strict accordance with the Manual's steps. Keep a distance over 1-2m with others while using the product, to avoid injury when the product crashes into people's head, face and body.
05. The product should be assembled by an adult. Users aged below 14 should not handle the product alone.
The battery should be charged under the supervision of an adult and by avoiding inflammables.

06. Keep the product out of children's reach to avoid eating it by mistake, because it contains small parts.
07. Do not use the product on the road or in water to avoid an accident.
08. It is forbidden to dismantle or refill the product, except for the propellers; otherwise, an anomaly may occur.
09. Please recharge the intelligent battery with USB charger that conforms to FCC/CE standard.
10. The remote controller has a built-in 3.7V lithium battery which needs no replacement.
11. Do not short-circuit or squeeze the battery to avoid explosion.
12. Do not place the battery in hot place (in fire or near electric heater).
13. Keep a safe distance from the propellers which are revolving at a high speed; do not use the product in the crowds to avoid scratch or injury.
14. Do not use the product in places with strong magnetic field, such as near high-voltage cable, buildings which contain metals, automobiles and trains; otherwise, the product can be disturbed.
15. Please do master local laws and regulations, to avoid violation of regulations.
16. Stop using the remote controller within the radio control period and region of national departments as specified, in order to conform to the requirements for magnetic environment of aeradio.
17. Avoid low-altitude flight above water surface.
18. Keep it away from airport, airline and other no-fly zone.

2. Reading Tips

» 2.1 Symbols

- ⊘ Prohibited ⚠ Important 💡 Operation & use prompts 📄 Technical Terms and reference information

» 2.2 Suggestions of Use

1. User is highly suggested to watch the tutorial video and **Quick Start Guide** before consulting the **Manual**.
2. Make sure to read **Disclaimer & Precautions** first when consulting the **Manual**.

» 2.3 Tutorial Video / Download App

Scan the QR code on the right and you can:

1. Download PotensicPro App (hereinafter referred to as "the App").
2. Watch the tutorial videos.
3. Access the latest User Manual.
4. Learn about the frequently asked questions(FAQ).



» 2.4 Registration & Help

Make sure to register personal account in App before the first flight, in order to get better use experience.

Registration Procedures

Please fill your E-mail, password, check the protocol and tap "Register". You can login the system after registration.

(Note: An Internet connection is required for registration)

Help

Thanks for purchasing ATOM drone. Please read the Manual carefully.

Please contact our support team at support@potensic.com if anything needs help, when requesting an after-sales service, it is required to submit order ID and details of the issues.

» 2.5 Technical Terms

IMU	IMU (inertial measurement unit), the most important core sensor of the drone.
TOF (Time of Flight)	TOF (time of flight), the period from transmission and receiving of detection infrared signal, in order to determine the target distance.
Downward Vision System	The sensor system, which lies at the bottom of the drone and consists of camera and TOF module.
Vision Positioning	High-accuracy positioning, which is realized through Downward Vision System.
Compass	Identify direction for geomagnetic sensor and the drone.
Barometer	Atmospheric pressure sensor, which enables the drone to determine the altitude through atmospheric pressure.
Lock/unlock	Switch the drone motor from static status to idle running.
Idling	Once unlocked, the motor will start spinning at a fixed speed, but it can't provide sufficient lifting force for the drone to take off.
Auto return	The drone will return to HOME point automatically based on GPS positioning.
Drone head	Position of the drone camera.
Throttle control stick	Ascend or descend the drone.
Pitch control stick	Fly the drone to front or back.
Roll control stick	Fly the drone to left or right.
Yaw control stick	Enable self-rotation of the drone to left or right.

3. Overview

This chapter introduces the functional characteristics of ATOM, as well as the diagrams of the drone and the remote controller.

» 3.1 Introduction

With foldable arms and weight below 250g, the product is portable and easy to use. The product is equipped with a vision positioning system, to realize precise hovering at low altitude indoor and outdoor environment.

Meanwhile, the product is equipped with a GPS sensor to realize positioning and auto return. With 1/3" Sony CMOS image sensor, the product can shoot 4K/30FPS HD video and 12MP pictures. The camera is mounted on a 3-axis gimbal, which allows the camera to acquire stable footages while operating the drone.

By using the brand new PixSync 3.0™ 2.4G digital video transmission technique, the ATOM remote controller can achieve 6 km communication distance and 720P HD video transmission maximally at ideal conditions. Open the pull-type and the foldable remote controller to stabilize your mobile device. Connect the remote controller and mobile device with USB cable to operate and set the product through App and view HD video transmission feed. The built-in lithium battery of the remote controller can work for approx. 2.3h max.

ATOM uses proprietary SurgeFly™ flight control technology, with a maximum horizontal flight speed of 16m/s (52ft/s), a maximum flight time of about 32 minutes, and the ability to withstand winds of up to level 5.

⚠ Test conditions of the max. flight time: Fly at an even speed of 5m/s at 25°C and in breezeless condition.

Test conditions of the max. transmission distance: Measured at an open and no-interference environment, with a flight height of 120m, and without considering the return of the drone.

Power consumption will increase considerably when the drone is returning against the wind. If you receive a prompt of encountering strong wind from the App, please make sure to lower the flight altitude and return in time to ensure safety of the drone.

Pre-Flight Checklist:

1. Pay attention to the local weather forecast and make sure it is suitable for flying the drone.
2. Make sure the battery is fully charged.
3. Make sure the firmware is updated to the latest version.
4. Make sure the flight environment is open and free of interference.
5. Before takeoff, make sure the battery is secured and the buckle pops out correctly, and no deformed propellers and loose screws.
6. Power on the drone on open and level ground, wait for the drone to enter GPS Mode before takeoff, and pay attention to the HOME point.

» 3.2 Drone Diagram

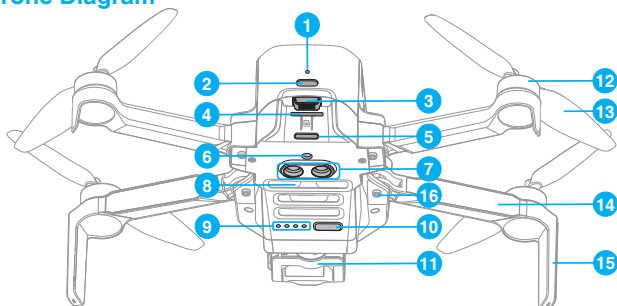

1. Charging indicator

2. TYPE-C charging port

3. Battery buckle

4. SD card slot

5. Tail indicator

6. Monocular visual module

7. TOF module

8. Bottom cooling hole

9. Power indicator

10. Power/frequency pairing button

11. 3-axis gimbal and camera

12. Brushless motor

13. Propeller

14. Arm

15. Antenna tripod

16. Arm shaft

» 3.3 Remote Controller Diagram

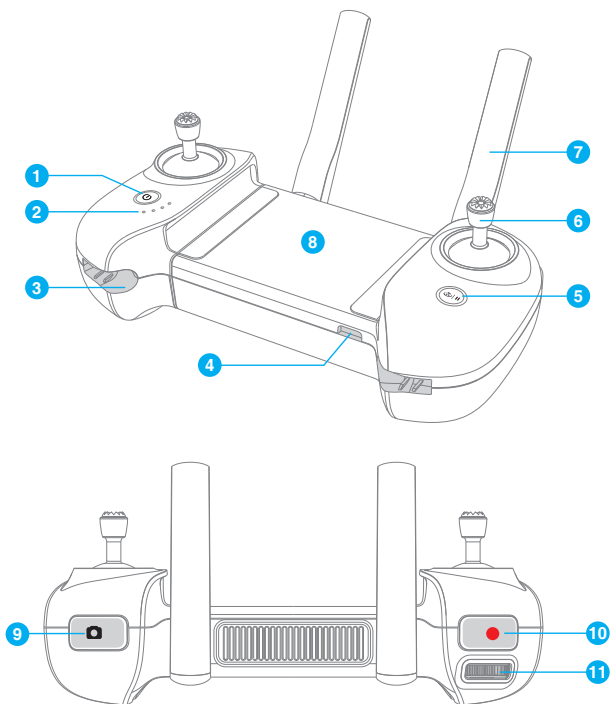

1. Power button

Long press it for 2s to power on/off.

2. Power indicator

Indicate the power level or other status of the remote controller.

3. Control stick slot

One slot respectively at the left and right side, which are used to store the sticks.

4. TYPE-C interface

To charge the remote controller/connect mobile device.

5. RTH / Pause button

Long press for 1s to return to HOME point automatically.
Short press it to pause auto flight.

6. Control stick

7. Foldable dual antennas

8. Installation position of mobile device

To place mobile device.

9. Shoot button

Short press it to shoot one picture.

10. Record button

Short press it to start/stop recording.

11. Gimbal dial

Use the gimbal dial to control the tilt of the camera.

» 3.4 Preparing the Drone

The product is delivered under folded status. Please unfold it as follows:

1. Remove the gimbal protector.
2. Unfold the front arm before the rear arm.
3. Unfold the propeller blades.

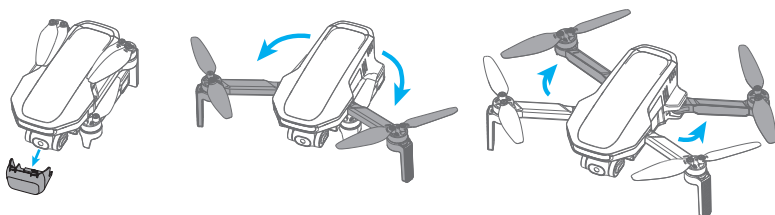

» 3.5 Preparing the Remote Controller

Installation of mobile phone and control stick

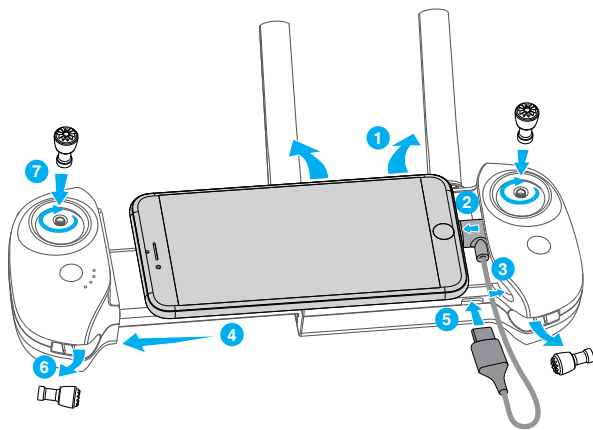

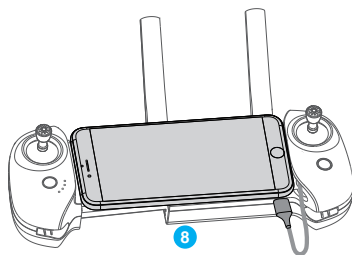

1. Unfold the antenna.
2. Connect your mobile phone to the USB cable.
3. Insert the part of your mobile phone with the USB cable into the slot of the remote controller.
4. Pull and open the remote controller with both hands and fix your mobile phone stably.
5. Connect the other end of the USB cable to the remote controller.
6. Take out the sticks.
7. Screw in both control sticks clockwise.
8. Installation completed.

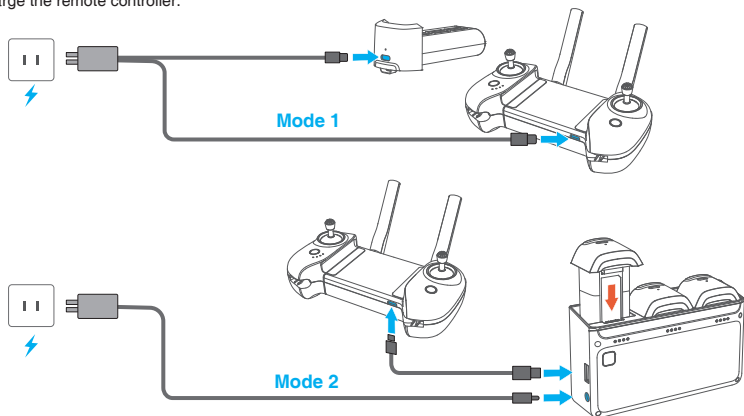

» 3.6 Charging / Startup and Shutdown

When receiving a new drone battery, it is required to charge it to wake it up, otherwise the drone wouldn't start. Connect the TYPE-C charging port of battery and a USB charger to the AC power supply to finish one-time charging (USB charger is not included in the package. User can use the charger that conforms to FCC/CE specification to charge the battery). The red indicator will stay on during charging, and turn off automatically after charging is done. User can charge the battery with the Parallel Charging HUB if fly expansion kit is purchased. For more details, please refer to User's Manual of Parallel Charging HUB. The Parallel Charging HUB can also charge the remote controller.



 The shortest charging period is approx. 1h 25min through the type-C charging port. Make sure your charger supports 5V/3A output in order to achieve this charging speed.

User is suggested to charge the battery through the Parallel Charging HUB, in order to charge 3 batteries quickly at the same time.

 It is suggested to remove the battery from the drone to charge for the sake of safety; otherwise, the drone won't power on if the battery is being charged in the drone.

If the charging cable is connected while the drone is on, it will power off automatically and the charging will continue.

The battery may become too hot after use; do not charge it until it cools down; otherwise, charging can be rejected by the smart battery.

Charge the battery on a trimonthly basis to maintain the activity of the cell.

Please connect the original cable or any cable that supports over 3A current to the type-C port; otherwise, it may cause charging failure or battery damage.

Startup

Drone: Make sure the battery is inserted in battery bin, short press and then long press the power button until all indicators are on, and then release the button to start up.

Remote controller: Long press the "Power" button until all indicators are on, and then release the button to finish startup.

Shutdown

Drone: Short press and then long press the power button of the drone until all indicators are off, and then release the button to shut down.

Remote controller: Long press the power button until all indicators are off, and then release the button to shut down.

4. Drone

The product consists of a flight control system, a communication system, a positioning system, a power system and a smart flight battery. This chapter sets down the functions of all parts of the drone.

» 4.1 Positioning

ATOM adopts Potensic's new SurgeFly™ flight control technology, which supports the following two positioning modes:

GPS positioning: Provide precise positioning and navigation to the drone; support precise hovering, smart flight and auto return.

Vision positioning: It can realize high-precision positioning at a low altitude based on the Downward Vision System. The vision positioning can be realized without GPS signal, so that the product can be used indoors.

How to switch: The flight control system will switch automatically according to the environment of the drone. If both GPS and Downward Vision System fail, the flight control will be switched to attitude mode, under which, the drone fails to realize stable hovering and user needs to correct the flight gesture manually through the control stick.

The difficulty of drone handling will be increased greatly in ATTI Mode; make sure to master the behaviors and operation of the drone in this mode before using this mode; avoid flying the drone at a long distance, to avoid risks due to failed judgment of drone gesture.

⚠ **The flight speed will be limited in vision positioning (OPTI mode).**
When the GPS signal is weak or there is no GPS signal, you will not be able to return the drone and activate certain functions such as Waypoint Flight or QuickShots.

⊘ **The difficulty of controlling the drone will increase dramatically in ATTI Mode so make sure to master the operation of the drone in this mode. Always keep the drone within sight in order to avoid risks in case of failed judgment of the drone's attitude and direction.**

» 4.2 Downward Vision System

The ATOM is equipped with a downward vision system, it is located beneath the drone. The Downward Vision System consists of a monocular camera and a TOF module. The TOF module includes a transmitter tube and a receiver tube, it can precisely calculate the fly height above the ground by calculating the infrared signals transmission and receiving time. In combination with the monocular camera, the system can help achieve high-precision positioning at low altitudes.

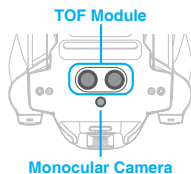

Detection Fileds

The Downward Vision System works best when the drone is at an altitude of 0.3 to 5 m, and its operating range is 0.3 to 10 m.

When GPS is unavailable, the Downward Vision System will be activated if the drone is flying over discernible surfaces with sufficient light. The Downward Vision System works best when the drone is at an altitude of 0.3 to 5 m. If the drone's altitude is above 5 m, the Vision System may be affected, so extra caution is required.

How to use

The Downward Vision System will be activated automatically if the positioning conditions are satisfied. The drone tail indicator blinks cyan twice, which indicates the Downward Vision System is working.

Speed limit: To ensure positioning accuracy and flight safety during vision positioning flight, the drone will actively limit its flight speed.

 Vision positioning is only an auxiliary flight function, please always pay attention to the changes in the flight environment and positioning mode, and do not rely too much on the automatic judgment of the aircraft. Users need to control the remote controller at all times and be prepared to operate the drone manually at any time.

The Visual System cannot work properly when flying over the following surfaces:

1. Pure-color surface
2. Surface with strong reflection, such as smooth metal surface
3. Transparent object surface, such as water surface and glass
4. The moving texture, such as running pets and moving vehicles.
5. Scenarios with drastic change of light; For example, the drone flies to outdoor space with strong light from indoor space.
6. Places with weak or strong light.
7. The surface with highly repetitive texture, such as floor tile with the same texture and small size, and highly consistent strip pattern.

For the sake of safety, please check the camera and TOF transceiver tube before the flight, and clean it with a soft cloth if there is any dirt, dust, or water on it; Contact Potensic Support if there is any damage to the Vision System.

» 4.3 Drone Status Indicator

Start-up/ Shut-down	Startup / Shutdown in progress: Green indicator is solid on			
Flight status	GPS positioning	Vision positioning	Attitude mode	Return
	Indicator flashes slowly in green	Indicator flashes slowly in cyan	Indicator flashes slowly in blue	Indicator flashes slowly in red
Warning & Error	Remote controller has no connection with the drone (communication lost)	Low battery	Sensor error	Emergency stop of propeller
	Indicator is in solid blue	Indicator flashes quickly in red	Indicator is in solid red	Indicator repeatedly lights up shortly in red then goes off long
Upgrade & calibration	Compass calibration (horizontal)	Compass calibration (vertical)	Frequency pairing mode	Upgrade mode
	Indicator has alternative flashing between red and green	Indicator has alternative flashing between blue and green	Indicator flashes quickly in green	Indicator flashes quickly in blue

» 4.4 Smart Battery

4.4.1 Function

ATOM smart battery is mounted with high-energy cell and advanced BMS. The details are as follows:

Basic Parameters			
Model: DSBT02B			
Cell Qty.	2 series	Battery Capacity	2230mAh
Rated Voltage	7.7V	Charge Completion Voltage	8.8V
Charging Mode	TYPE-C/ Parallel Charging HUB	Max. Charge Current	TYPE-C: 5V/3A Parallel Charging HUB: 8V/2.0A x 3

Function	Description
Balance protection	Balance cell voltage automatically to guarantee battery health.
Self-discharge protection	If the battery is fully charged and left idle, it will slowly self-discharge to 50%-70% after 5 days to protect the battery cells.
Overcharge protection	Charging will stop once battery is fully charged, otherwise the battery can be damaged by overcharging.
Temperature protection	Please pay attention to your charging environment, otherwise charging will be stopped automatically when battery temperature is below 0°C or above 40°C.
Intelligent current limiting of charging	When charging current is too high, the battery will restrict current automatically in order to protect the battery.
Overdischarge protection	In non-flight status, the battery will cut off power supply automatically to avoid over-discharge when battery is discharged to a certain level; at this time, the battery will enter sleep status. It is suggested to charge the battery ASAP.
Short-circuit protection	When the drone short-circuit is detected by the battery, the power supply will be cut off automatically to protect the battery and the drone.
Battery health monitoring	The BMS will monitor the battery health condition, prompt battery damage in App in case of cell damage, cell voltage unbalance or other battery errors, to remind user to replace the battery in time.
Communication function	The battery can communicate with the the drone in real time. User can view the information in App, such as battery circulation times and real-time electric quantity.

 If the battery is not used for a long time, it needs to be charged every three months to ensure its health.
Please store the battery in a cool, dry place where children cannot touch it.

4.4.2 Battery Installation & Removal

Installation:

Push the battery into the product's battery bin horizontally as shown in picture below, the battery buckle is bounced and locked when hearing "click" sound.

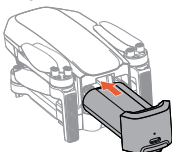

Removal:

Firstly, press the buckle of smart battery, hold the upper cover of battery to pull out the battery.

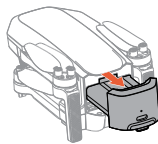

⚠ Once the battery is inserted, make sure the battery buckle is bounced properly. This step is highly important and related to flight safety.

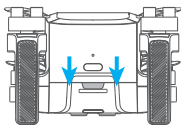

Make sure to power off the product before removing the battery.



Buckle is in position, safe



Buckle is not in position, which may result in the battery falling during flight.

4.4.3 Charging

See 3.6 for charging method

4.4.4 View Power Level

Once the battery is inserted in the drone, short press the power button to view the power level of smart battery, as shown in the picture below:

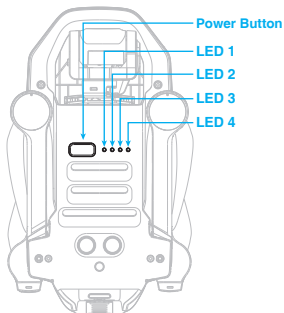

LED 1	LED 2	LED 3	LED 4	Current power level
☀	●	●	●	0%~25%
☀	●	●	●	25%~30%
☀	☀	●	●	30%~50%
☀	☀	●	●	50%~55%
☀	☀	☀	●	55%~75%
☀	☀	☀	●	75%~80%
☀	☀	☀	☀	80%~97%
☀	☀	☀	☀	97%~100%
☀	☀	☀	☀	97%~100%

☀ Indicator is on ☀ Indicator is flashing ● Indicator is off

4.4.5 Operation Instructions of Smart Battery at High/Low Temperature

When the battery temperature is $< 5^{\circ}\text{C}$, the App will prompt a low temperature warning of the battery, and the battery needs to be preheated before flying.



When the battery temperature is $> 70^{\circ}\text{C}$, the App will prompt a high temperature warning of the battery, and the drone will not be able to fly.

⚠ The discharge capacity will be weakened greatly and flight duration will reduce at a low temperature, which is normal.

Avoid long-term running at a low temperature, otherwise, the battery life can be shortened.

» 4.5 Propellers

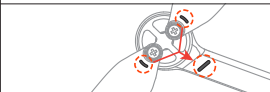
There are two types of ATOM propellers, which are designed to spin in different directions. Marks are used to indicate which propellers should be attached to which motors, the two blades attached to one motor are the same.

	Propeller	Installation Instructions	Schematic Diagram of Installation
Marked propeller		Install the marked propeller blades on marked arm	
Unmarked propeller		Install the unmarked propeller blades on unmarked arm	

-  Use the the screwdriver from the package to mount the propellers.
Hold the motor to remove the propeller blades easier.

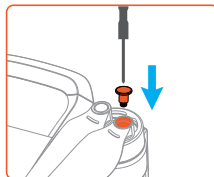

-  Make sure you attach the marked propellers to the motors of the arm with marks and the unmarked propellers to the motors of the arm without marks. Otherwise the drone will be unable to fly.
If a propeller is broken, remove the two propellers and screws on the corresponding motor and discard them. Use two propellers from the same package. DO NOT mix with propellers in other packages.
Propeller blades are sharp. Handle with care. DO NOT squeeze or bend the propellers during transportation or storage.
Purchase the propellers separately if necessary.
Stay away from the rotating propellers and motors to avoid injuries.
Please check the propeller blades immediately if there are any jitters or speedless in flight, and timely replace the propellers if it's damaged or deformed.
Make sure the motors are mounted securely and rotating smoothly. Land the drone immediately if a motor is stuck and unable to rotate freely. Stop flying the drone and contact support if there is any abnormal sound with the motor.
Make sure that the propellers are installed securely before each flight. Check to make sure the screws on the propellers are tightened.

-  When mount or remove the propellers, do not put the screwdriver or other foreign materials inside the motors, or the motor may be damaged.



» 4.6 Flight Data

ATOM supports recording of flight data. User can view the data in App.

"Flight record" displays the basic data for each flight of user.

"Flight log" records the detailed flight data of user. For any abnormal circumstance in flight, user can report it in App and, if necessary, upload the flight log to seek for assistance.

-  All flight data are stored in user's mobile device. No flight data will be acquired by the Company, except for the data uploaded by user to the cloud storage.

» 4.7 Gimbal and Camera

4.7.1 Three-Axis Gimbal

ATOM is equipped with a 3-axis gimbal, allowing you to capture clear and stable images and videos. The control pitch range is from +20° to -90°, the control roll and yaw range is from +10° to -10°. The pitch angle of the gimbal can be adjusted by scrolling the gimbal dial on the remote controller.

In Video Mode, the control pitch range of the gimbal is +20° to -90°; Otherwise, the control pitch range is 0° to -90°.

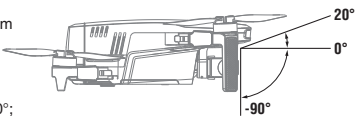

⚠️ Make sure to remove the gimbal protector before powering on the drone.
After each startup the default tilt angle of the gimbal is 0° (namely the horizontal view)

⚠️ DO NOT collide, tap or apply external force to the gimbal to avoid damaging the precision elements inside.
Make sure that there are no objects on or around the gimbal and the lens is not dirty before taking off.
The gimbal is connected to the drone through elastic and shock absorption support, to eliminate camera vibration. Do not pull the gimbal by force. For any damage of shock absorption support, please contact the after-sales team for repairing.

⊘ DO NOT modify the gimbal or stick objects on it, otherwise this will cause the gimbal to shake or lead to permanent gimbal motor damage.

4.7.2 Camera

Basic Parameters	
Sensor brand: SONY	Sensor size: 1/3" CMOS
Effective pixel: 12MP	Aperture: F2.2
FOV: 78°	Focus range: 3m ~ ∞
ISO range: 100-6400	Shutter range: 1/24-1/25,000s
Memory: Micro SD card	Picture format: JPG/JPG+RAW(DNG)
Picture size: 12MP (4,608*2,592)	Code: H.264
Video format: MP4	
Video Resolution: 4K@30/25/24fps; 2.7K@30/25/24fps; 1080P@60/50/30/25/24fps	

⚠️ The gimbal may shake when flying in Sport Mode or strong wind. It is recommended to fly the drone in Video Mode to acquire optimal gimbal stabilization.
Do not touch the lens after recording for a long period of time to avoid scald.
Do not record video when the drone is not flying; otherwise the drone will trigger overheat protection.
The sensor will crop out the edges at 1080P@60/50fps, it's simply capturing a central section of what the full-frame sensor would capture, and FOV is about 36°.

4.7.3 Image Storage

The videos and pictures recorded by ATOM will be stored in SD card, instead of App or user's album. Make sure to insert SD card prior to flight. Otherwise, it is unable to record and shoot.

User can preview and download the videos and pictures (the drone and the remote controller should be connected) in App.

SD Card Requirements

File format: FAT32, exFAT

Capacity: 4G-256G

Speed requirements: It is suggested to use SD card above U1 (UHS Speed Class 1) or C10 (Class 10)

⚠️ The video downloaded from App is just 720P image used in video transmission. Please read SD card with computer or other device in order to acquire videos of higher definition.

⚠️ The recording can be terminated due to slow write-in when using the U1/C10 SD cards of certain brands.
If important data are stored in your SD card, please backup them properly.
Do not insert or unplug the SD card when the product is powered on. It may lead to data damage or loss, or even SD card damage when inserting or unplugging SD card during video recording.
Potensic does not bear responsibility for any loss due to user's misoperation of SD card.

5. Remote Controller

» 5.1 Overview

Potensic ATOM is equipped with the DSRC02A remote controller, which boasts Potensic long-range PixSync 3.0™ video transmission technology, offering a maximum transmission range of 6km/19,685ft and 720p when displaying video from the drone to PotensicPro App on your mobile device. Easily control the drone and camera using the onboard buttons. The detachable control sticks make the remote controller easier to store. Thanks to the 2.4Ghz dual band antenna, in a wide-open area with no electromagnetic interference, PixSync 3.0™ smoothly transmits video feed at up to 720p at a max altitude of 120m.

The built-in battery has a capacity of 3000mAh and a maximum run time of 2.3 hours. There is a Type-C port for device connection. The remote controller charges the mobile device with a charging ability of 500mA/5V.

💡 When used with different drone hardware configurations, the remote controller will automatically select the corresponding firmware version for updating and support the following transmission technologies enabled by the hardware performance of the connected drone models:

- a. ATOM SE: PixSync 2.0™ b. ATOM: PixSync 3.0™

» 5.2 Control Stick Mode

Mode 1 (Left Hand Throttle)

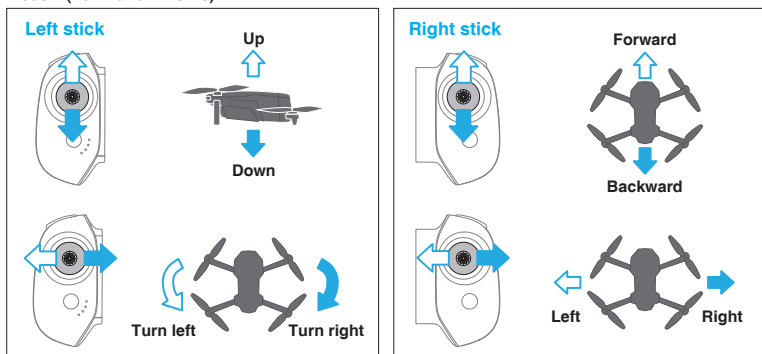

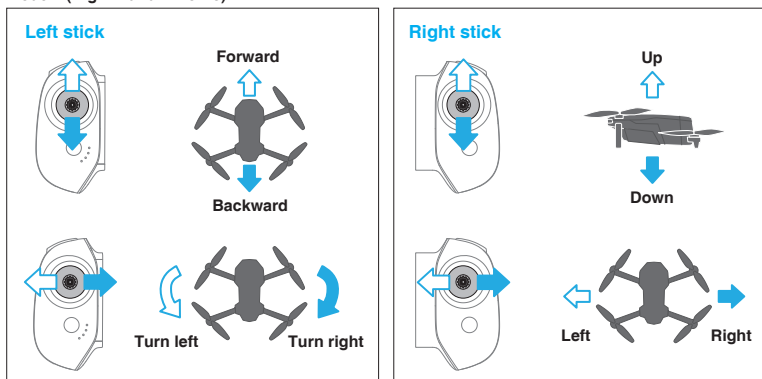

Mode 2 (Right Hand Throttle)

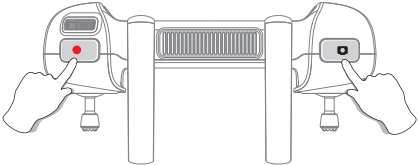

» 5.3 Function

5.3.1 Function List

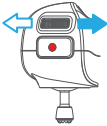
Charge	<ol style="list-style-type: none"> 1. Connect the USB Charger to the Type-C charging port. 2. The battery is being charged when power indicator starts flashing. 3. Charging is completed when 4 LED indicators are solid on and data cable can be removed.
Recharge mobile phone	When a mobile device is connected, the remote controller automatically charges devices with a charging ability of 500mA/5V.
Indicator function	See 5.3.2
Flight control	See 5.2
Low battery prompt	When power level of the remote controller is lower than 10%, the remote controller will have a "beep" sound every second.
Auto shutdown	The product will shut down automatically if the remote controller has no connection and operation for 20mins.
One-key return	See 7.8
Pause	If the drone is performing a Smart Flight like Circle Flight or auto landing, press once to make the drone brake and hover in place. Press again to cancel it and regain the control of the drone.
Emergency stop	<p>For any emergency situations during the flight, press "Shoot" and "Record" button for 2s at the same time till the remote controller beeps, the drone will stop running and fall down.</p> 
Shoot	<p>Short press it to shoot one picture</p> <p>When camera is in video recording mode, short press it to switch to shoot mode</p> 
Record video	<p>Short press it to start/stop video recording</p> <p>When camera is in shooting mode, short press it to switch to video recording mode</p> 
Gimbal Dial	<p>Dial it to the right to increase the pitch angle (head up)</p> <p>Dial it to the left to decrease the pitch angle (head down)</p> 
Remote controller frequency pairing	See 5.3.3

5.3.2 Indicator

As shown in the picture below, the remote controller is fitted with 4 white LED indicators to indicate the power level and other status.

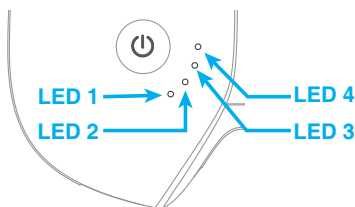

Indicator is on



Indicator is flashing



Indicator is off

Charging indication

LED 1	LED 2	LED 3	LED 4	Current power level of battery
				0%~25%
				25%~50%
				50%~75%
				75%~99%
				99%~100%

Power indication (in use)

LED 1	LED 2	LED 3	LED 4	Current power level of battery
				0%~10%
				10%~25%
				25%~50%
				50%~75%
				75%~100%

Status indication

	LED 1	LED 2	LED 3	LED 4
Frequency pairing				
	Flashing slowly at the same time			
Upgrade mode				
	Turning on sequentially			
Start calibration				
	Flashing slowly at the same time			

5.3.3 Remote Controller Function

The ATOM drone and the remote controller can be used immediately after startup since they have been paired before delivery. Frequency pairing is only required when using a new drone or remote controller for the first time. Proceed frequency pairing between the drone and the remote controller by tapping "Drone Re-pairing" under Calibration in App Settings. See 8.5 Remote Controller Calibration for the detailed procedures.

» 5.4 Antenna Angle

Adjust the antenna angle along with the changes of drone height and distance, to ensure the best communication status of the remote controller.

Wider communication angle is ensured at a close distance in this mode.

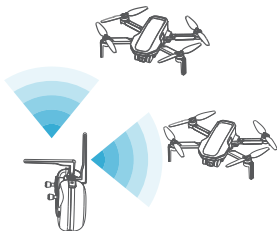

Keep both antennas pointing directly towards the drone to acquire a longer transmission distance.



When the drone is right above the remote controller, the transmission signal is weakened drastically due to poor antenna angle. Please lower the flight altitude or fly the drone horizontally for some distance with the antenna pointing at the drone as much as possible as shown in the picture.



Do not cross the antenna in any case.

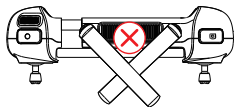

Do not press the antenna on your mobile device in any case.

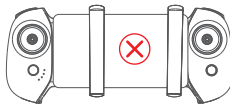

6. PotensicPro App

» 6.1 App Homepage



Tap to view the flight logs and Potensic Academy

Tap to choose the corresponding model. The drone model will be matched automatically if user has connected the remote controller to the mobile phone

Display connection status



Tap to enter the flight interface

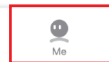

Me: Report a problem, modify account info, browse User Agreement, find the missing drone, close account and other settings

Photo album in App (Connect the drone to see the contents in the drone SD card)

Homepage of App

>> 6.2 Flight Interface

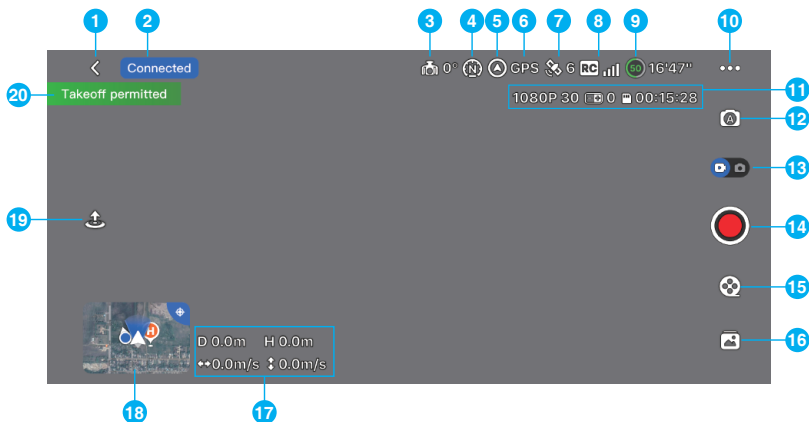

1. Return button:

Tap to return to the homepage

2. Navigation prompt bar:

Display drone status and flight mode



3. Gimbal angle:

Display current gimbal pitch angle

4. Flight mode:

-  Video
-  Normal
-  Sport

5. Head / Headless mode:

-  Head mode
-  Headless mode

10. Settings

Tap to view information about Safety, Calibration, Control, Camera and About.

Safety

Switch on or off Beginner Mode: If switched on, the drone will be confined to fly in a cylindrical space with a radius of 30 m and a height of 30 m and restricted to fly only in Video Mode.

Set measurement system (Metric or Imperial) and speed (Video/Normal/Sport)

Set drone behavior when signal lost: Return/Land/Hover

Return — the drone will automatically ascend to 120 m and return to the HOME point.

Land — the drone will land on the spot where it loses the signal.

Hover — the drone will hover in place where it loses the signal.



Set minimum return altitude and virtual fence.

Battery information: check the temperature, current, voltage and others of the smart battery.

Calibration

This sector includes compass calibration, gimbal calibration, gimbal fine-tuning, remote controller calibration and drone re-pairing.

6. Positioning mode:

-  GPS GPS positioning
-  OPTI Vision positioning
-  Atti Attitude mode, no positioning

7. GPS status:

Display GPS signal status and quantity of satellites searched

8. Signal quality of video transmission:

Display the strength of video transmission connection signal between the drone and the remote controller

9. Power level of the smart battery:

16'47" Estimated Remaining Flight Time

Control

Remote Controller Settings: Tap to switch control stick mode (Mode 1: Left Hand Throttle; Mode 2: Right Hand Throttle)

Drone Settings: Tap to switch on / off Headless Mode (When initiating RTH, Waypoint Flight, QuickShots or restarting the drone, it will automatically exit Headless Mode)

Gimbal Settings: Tap to set gimbal maximum pitch speed, gimbal angle (0°/-90°), and to switch between Gimbal Stable Mode or FPV Mode.

Camera

General Settings: Tap to set white balance, gridlines, segmental recording, etc. Tap to check microSD card capacity and format.

Other Settings: Tap to set watermarks and add GPS coordinates in photos.

About

View device information, firmware information, App version, etc.

11. Shooting Information Display/Settings

 **Photo Mode:** displays photo format, EV (exposure value) and the remaining numbers of photos or the available capacity of the current microSD card.

 **Auto Mode:**



Tap  to switch between the display of the remaining numbers of photos or the available capacity of the current microSD card.

Tap  to set EV.

Tap  to set photo format to JPG or RAW+JPG.

 **Manual Mode:**

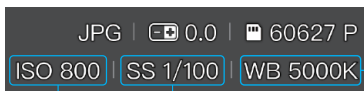

Tap  to set white balance.

Tap  to set camera SS (shutter speed).

Tap  to set ISO (light sensitivity).

 **Video Mode:** displays video resolution, EV (exposure value) and the remaining video recording time or the available capacity of the current microSD card.

 **Auto Mode:**



Tap  to switch between the display of the remaining video recording time or the available capacity of the current microSD card.

Tap  to set EV.

Tap  to set video resolution and frame rate.

4K: 30/25/24fps

2.7K: 30/25/24fps

1080P: 60/50/30/25/24fps

 **Manual Mode:**

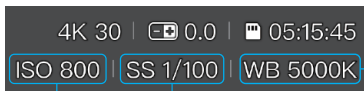

Tap  to set white balance.

Tap  to set camera SS (shutter speed).

Tap  to set ISO (light sensitivity).

12. Camera Manual/Auto Mode

- Auto Mode
- Manual Mode: Tap to manually adjust ISO, shutter time, white balance, and set the parameters by observing the exposure value(EV)

13. Shoot/record switch button:

- to switch from shooting to video recording
- to switch from video recording to shooting.

14. Shoot/Record button:

- Video recording mode, tap to start video recording
- Video recording in progress, tap to cancel
- Shooting mode, tap to shoot picture

15. Intelligent Flight Modes

- QuickShots shooting modes: Pull-Away, Rocket, Circle, Spiral and Boomerang. The drone records the target according to the selected shooting mode and automatically generates a short video which will be saved in MicroSD card.
- Visual Tracking: The drone tracks automatically the targeted subject to record and generates a short video which will be saved in MicroSD card.
Please watch the tutorial videos for detailed instructions!

16. Album: Preview or download shot videos or pictures in SD card.

17. Display flight speed and distance

- Horizontal distance from the drone to HOME point
- Relative height from the drone to HOME point
- Flight speed of the drone
- Ascent/descent speed of the drone

18. Attitude Indicator/Thumbnail map

Tap the upper right corner to switch to Attitude Indicator Mode

Tap thumbnail map to switch to full-screen map

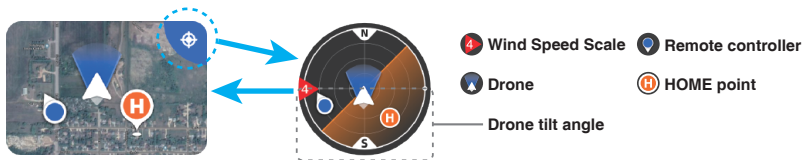



The attitude indicator displays information of drone direction, tilt angle, remote controller direction, HOME point and more.

The attitude indicator can show the angle and direction of the drone in real time as follows:

Legend				
Tilting direction of the drone	Tilt forward: the horizon line tilts towards the upper half of the attitude indicator	Tilt backward: the horizon line tilts towards the lower half of the attitude indicator	Tilt to the right: the horizon line tilts towards the right side	Tilt to the left: the horizon line tilts towards the left side

Different colors of the attitude indicator:

Legend	Description
	Green indicates that the drone is flying at a relatively small tilt angle, high precision control over the gimbal and optimal video quality can be achieved.
	Yellow indicates that the drone is flying at a relatively large tilt angle, the control precision of the gimbal may be affected, and the video quality may be reduced.
	Red indicates that the drone is flying at a very large tilt angle. If the attitude indicator frequently turns red during flight, the drone may be encountering strong winds and the video quality can be compromised. Please fly the drone back and land it as soon as possible.

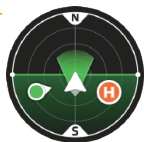

When the icons of the drone and the remote controller both turn green, it indicates that the remote controller is facing the drone which guarantees the optimal communication signal.

After the drone is powered on and enters GPS mode, the current GPS coordinates will be updated as the HOME point. Pay attention to the update prompt of the HOME point.



When the drone takes off in OPTI mode and then enters GPS mode, the HOME point is no longer the take-off point. Pay attention to the return safety.

19. One-key takeoff, landing/return

The App will display different buttons based on drone status. Tap to initiate one-key takeoff, landing or return.



Tap to unlock, take off and hover at a height of 1.2m



Tap to land or auto return.

20. Display important information or status of drone



Make sure to fully charge the mobile device prior to flight, because the power of the mobile device will be consumed even if it is charged by the remote controller.

Mobile cellular data is required when using the PotensicPro App. Please contact your wireless carrier for data charges.

While using the App, make sure to read and master the pop-up prompts and warning information of App to know the current status of the drone.

It is recommended to replace any outdated mobile device which may have a negative impact on user experience of App and lead to potential dangers. For any poor user experience and safety problems due to the use of an outdated mobile device, Potensic does not bear any liability.

7. Flight

This chapter introduces safe flight practices and requirements.

» 7.1 Requirements of Flight Environment



1. Do not use the product in severe weather, such as gale, rain, snow and fog.
2. Only fly in open areas. Tall structures and large metal structures may affect the accuracy of the onboard compass and GPS system and result in positioning failure. It is recommended to keep the drone at least 5m away from structures.
3. Control the product within your sight and keep away from the obstacles and crowds.
4. Do not use the product in places with high-voltage power lines, telecommunication base station or launching tower, to avoid interference of the remote controller.
5. Please use the product with caution when altitude is over 3,000m for the flight performance can be affected when the performance of drone battery and power system is weakened due to environment factor.



» 7.2 Precautions of Flight

1. Check if the remote controller, intelligent flight battery and mobile device are fully charged.
2. Check if the drone is intact and propellers are installed correctly.
3. Check if the camera is working normally after power-on.
4. Check if App is running normally.
5. Check if SD card is inserted and make sure camera is clean.
6. Make sure the drone takes off on flat and hard surface, instead of sandstone or bush; the drone may fail to be unlocked if it has major vibration.
7. Please be careful when the drone takes off on surface of moving objects, such as running vehicle and ship.
8. GPS positioning and waypoint flight will be disabled in the south and north polar.
9. Do not use the product in extremely cold or hot place to avoid hazards.

» 7.3 Connection

Please follow the steps below:

1. Please finish the steps in "3.5 Preparing the Remote Controller" and turn on the remote controller.
2. Please finish the steps in "3.4 Preparing the drone" and turn on the drone.
3. Launch App to view the connection status. Connection is finished when it shows .
4. Tap  to enter the flight interface.

 It is advised to tap  and follow the animated guide to operate for first-time users.

» 7.4 Flight Mode

ATOM has three flight modes-Video/Normal/Sport, which can be switched via the App.

Video Mode

Ascent speed: 2m/s, descent speed: 2m/s, flight speed: 6m/s

The drone enters Beginner Mode by default when being used for the first time. The flight speed will be limited to the same as in Video Mode to allow you to familiarize yourself with the controls of the drone.

Normal Mode

Ascent speed: 4m/s, descent speed: 3m/s, flight speed: 10m/s

You can exit Beginner Mode after you have mastered adequate flight skills, and the drone will switch to Normal Mode by default.

Sport Mode

Ascent speed: 5m/s, descent speed: 4m/s, flight speed: 16m/s

Video mode is recommended for aerial photography. Sport mode is recommended if you would like to get a speedy flight experience.

Please fly with caution in Sport Mode as the responsiveness of the drone significantly increases, which means a small control stick movement on the remote controller translates into the drone moving a large distance.

 Be vigilant and maintain adequate maneuvering space during flight, as the responsiveness of the drone significantly increases in Sport mode.

The maximum speed and braking distance of the drone significantly increase in Sport Mode. A minimum braking distance of 30 m (100 ft) is required in windless conditions to ensure safety.

When flying in Sport Mode or strong wind, the gimbal may shake, which is normal.

» 7.5 Beginner Mode

The drone is automatically set to Beginner Mode for first-time use. In beginner mode:

1. The flight distance and height will be restricted at 0–30m
2. The speed level will be restricted to the same as in Video mode
3. The beginners are suggested to learn and master the drone in beginner mode

» 7.6 Takeoff/Landing/Hovering

7.6.1 Manual Takeoff/Landing

Takeoff

Step 1: Start the motors

Use a combination stick command to start the motors. Push both sticks to the bottom inner or outer corner depending on your control stick mode to start the motors. Release both sticks simultaneously once the motors are spinning.

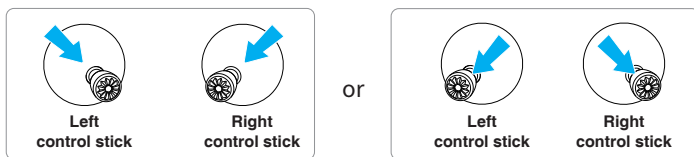

Step 2: Push throttle control stick to take off

Push the throttle control stick upwards gently as shown in the picture, release the control stick when the drone leaves ground and it will keep hovering.



Landing

Pull the throttle control stick until the drone lands on ground. Release the throttle control stick when the motors are no longer spinning.

Take off from stable and level plane, do not take off from or land on the palm or by hand.

-
- ⚠ Take off from stable and level plane, do not take off from or land on the palm or by hand.**
It is not suggested to take off at low battery, otherwise it may affect the battery service life. Please handle it with caution and undertake the corresponding consequences if compulsory takeoff is required.
Keep the distance over 0.5m between the drone and ground, otherwise it may fail to enter stable hovering status due to air flow when it is close to the ground.
If the drone fails to be locked after landing due to anomaly, pull down the throttle control stick to the limit position for 3s and the drone will be locked by force.
-

7.6.2 One-key Takeoff / Landing

One-key takeoff

Tap one-key takeoff button  in App, then swipe right in the pop-up window to start the drone automatically then ascend to the height of 1.2m and maintain hovering.

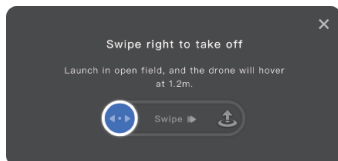





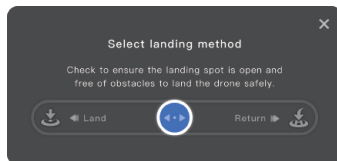









One-key landing

Tap one-key landing button  in App, then swipe left in the pop-up window to land the drone, or swipe right to start returning.



» 7.7 Intelligent Flight Modes

7.7.1 QuickShots

Introduction	QuickShots shooting modes include Pull-Away, Rocket, Circle, Spiral and Boomerang. The drone records the target according to the selected shooting mode and automatically generates a short video which will be saved in MicroSD card.		
How to Start	<ol style="list-style-type: none"> 1. Tap  in the App to start QuickShots. 2. Choose a shooting mode and set the parameters on the right. 3. Tap  or drag-select your target subject (It is recommended to choose a human as a target subject rather than a building), then tap  to begin recording. 		
How to Exit	<ol style="list-style-type: none"> 1. Tap  in the App or move a control stick to finish recording. The drone will hover in place. 2. Tap  on the right to exit QuickShots. 		
Explanation	Mode	Description	Adjustable Parameter
	 Pull-Away	The drone flies backward and ascends with the camera locked on the subject.	Return to the starting point after finishing recording?  Yes  No
	 Rocket	The drone ascends vertically with the camera pointing downward at the subject.	 Clockwise  Counterclockwise
	 Circle	The drone circles around the subject starting from current position.	
	 Spiral	The drone ascends and spirals around the subject.	Number of laps (choose from 1-3)
 Boomerang	The drone flies around the subject in an oval path, ascending as it flies away from its starting point to the farthest distance and descending as it flies backward.		

Conditions to activate QuickShots:

1. The drone is airborne with strong GPS signal;
2. MicroSD card is inserted with available storage;
3. Sufficient battery level;
4. The drone is not in auto-flight state (auto return or landing).
5. The drone must be at least 2 m above the ground.
6. When locking the target in QuickShots, the gimbal pitch angle needs to be between $-75^{\circ} \sim -15^{\circ}$.

 Use QuickShots at locations that are clear of buildings and other obstacles. Make sure there are no humans, animals, or other obstacles on the flight path.

Before getting familiar with the flight path of QuickShots, please try a smaller flight distance first.

Be ready to take over control of the drone by moving any control stick at any time in emergency and the drone will exit QuickShots and hover in place.

Pay attention to objects around the drone and use the remote controller to avoid collision with the drone or when the drone is being blocked.

DO NOT use QuickShots in places that are close to buildings or where the GPS signal is weak. Otherwise, the flight path will be unstable.

Make sure to follow local privacy laws and regulations when using QuickShots.

QuickShots is not available in the following situations:

1. The drone is on the ground.
2. GPS signal is weak.
3. MicroSD card is not inserted or no storage available.
4. The battery level is low.
5. The current altitude of the drone is insufficient.
6. The drone reaches the virtual fence.
7. The gimbal is horizontal or tilted upwards.







DO NOT use QuickShots in any of the following situations where the Downward Vision System may not work properly:

1. When the subject is blocked or outside the line of sight for an extended period.
2. When the subject is more than 50 m away from the drone.
3. When the subject is similar in color or pattern with the surroundings.
4. When the subject is in the air.
5. When the subject is moving fast.
6. When the ambient lighting is extremely low or high.

QuickShots does not support video recording in 1080P@60/50fps.

After the subject is locked in QuickShots, the gimbal pitch angle can't be adjusted.

7.7.2 Visual Tracking

Description	The drone tracks automatically the tracked subject to record and generates a short video which will be saved in MicroSD card.
How to Start	<ol style="list-style-type: none">1. Tap  in App the tap  on the right to start Visual Tracking.2. Tap  or drag-select your subject, and choose the recording period(1, 3, 5min or infinite∞).3. Tap  to start Visual Tracking.
How to Exit	<ol style="list-style-type: none">1. Tap  on the right or move a control stick during recording to stop and exit Visual Tracking and the drone will hover in place.2. Tap  on the right to exit Visual Tracking.

 Visual Tracking is unavailable when the drone is on the ground.

During Visual Tracking, the gimbal dial will remain unresponsive.

Once the tracked subject is lost, the drone will hover in place.

When the tracked subject is approaching the drone, it will hover in place and not move backwards.

When locking the target in Visual Tracking, the gimbal pitch angle needs to be between -75° ~ -25°.

The drone must be at least 4 m above the ground to activate Visual Tracking.

During Visual Tracking, the tracked subject should not move in a relatively high speed(recommended speed less than 4m/s)

 Use Visual Tracking at locations that are clear of buildings and other obstacles. Make sure there are no humans, animals, or other obstacles on the flight path.

DO NOT use Visual Tracking in places that are close to buildings or where the GPS signal is weak. Otherwise, the flight path will be unstable.

Be ready to take over control of the drone by moving a control stick at any time in emergency and the drone will exit Visual Tracking and hover in place.

Visual Tracking is not available when the drone is flying near distance and altitude limits.

Make sure to follow local privacy laws and regulations when using Visual Tracking.

Be extra vigilant when using Visual Tracking in any of the following situations:

1. The tracked subject is not moving on a level plane.
2. The tracked subject changes shape drastically while moving.
3. The tracked subject is blocked or out of sight for an extended period.
4. The tracked subject is moving at a fast speed.
5. The tracked subject has a similar color or pattern to its surrounding environment.
6. When the ambient lighting is extremely low or high.

It's recommended to maintain a distance of 5-10 m and an altitude of 4-10 m when tracking people. It's recommended to maintain a distance of 20-50 m and an altitude of 10-50 m when tracking vehicles or boats. Operate the drone outside of the recommended range and it may not detect well the intended subject.

7.7.3 Headless Mode

Description	Drone's head direction will not be considered in Headless Mode, pull the pitch control stick to make the drone leave or approach the HOME point; pull the roll control stick to make the drone fly clockwise or anticlockwise in circle along with HOME point; the functions of throttle control stick and yaw control stick remain unchanged.
How to Switch on/off	When the GPS signal is strong and the horizontal flight distance is over 3m, switch on/off the Headless Mode under Control in App settings.

 A safe round space which centers the HOME point with a radius of 10 m (32.8ft) will be created in Headless Mode. Move the pitch stick to fly the drone close to the safe space, and it won't continue to approach the HOME point.

7.7.4 Waypoint Flight

<p>Description</p>	<p>When Waypoint Flight is enabled, you can pin 2 or more waypoint coordinates in App map, and the drone will fly over the corresponding waypoints sequentially.</p>
<p>How to Start</p>	<p>When the GPS signal is strong, tap the map in the lower left corner of the App to switch to map, then tap  on the right to enter Waypoint Flight mode, tap on the map to pin multiple waypoints, after that tap  to start Waypoint Flight.</p>   <p>You can preset 2 to 30 waypoints on the map and the figure in the icon indicates the flight sequence.</p> <p>Meanwhile, you can delete certain waypoint, save the current Waypoint Flight task, or choose from the saved Waypoint Flight tasks.</p>
<p>How to Exit</p>	<ol style="list-style-type: none"> 1. Tap  on the right or move a control stick (except throttle control stick) to stop and exit the current Waypoint Flight task and the drone will hover in place. 2. Tap  on the right to exit Waypoint Flight.

 During Waypoint Flight, you can adjust the flight altitude via the throttle control stick and the gimbal tilt via gimbal dial.

 During Waypoint Flight, the drone will exit the current flight task and hover in place if it reaches the virtual fence.

» 7.8 Return(RTH)

The return consists of three steps, as follows:

1. **Ascent:** The drone ascends to the set return altitude (this step is skipped if the drone's altitude is already higher than the return altitude).
2. **Level flight:** The drone maintains a straight flight at the set altitude towards the HOME point.
3. **Landing:** Once it reaches the HOME point, the drone will automatically land and stop its propellers.

Return to Home (RTH) The drone must be in GPS mode

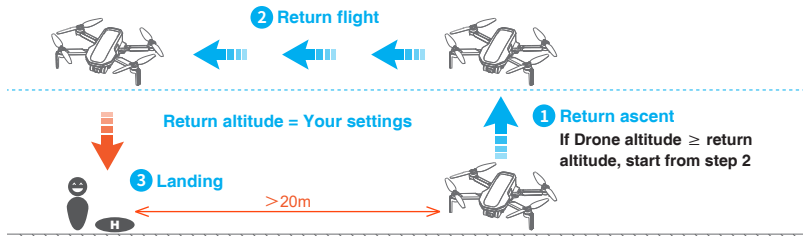

How to Start RTH

One key RTH: Press and hold the RTH button on the remote controller for 1s or tap  in App to pop up the menu, then swipe right to start the return.

Auto RTH: When either the drone battery level is low, the signal between the drone and the remote controller is lost or the drone is experiencing other abnormalities, Auto RTH will be triggered.

 If there are obstacles in the surrounding environment and it's not suitable to return, it is recommended to keep the drone hovering or land the drone after losing signal in Settings to avoid colliding with the obstacles during RTH.

How to exit RTH

Method 1: Tap  on the left of App to exit RTH.

Method 2: Briefly press the return button on the remote controller to exit RTH.

RTH Requirements

The drone must take off in GPS mode and successfully record the HOME point.

If the drone takes off in OPTI mode and switches to GPS mode mid-flight, it will not be able to return to the takeoff point.

Please pay attention to the location of the HOME point on the map and the prompts in PotensicPro App.

 The default return altitude is 30m, which can be modified in PotensicPro App.

During the return course, users can still adjust the flight altitude by adjusting the throttle.

The drone will return when it is within 20m of the HOME point, and the return altitude will be 5m. Please pay attention to safety.

Tall buildings or obstacles can block the transmission signal and cause signal loss. Do not fly behind buildings beyond the return altitude, otherwise the drone will collide with obstacles and crash during the return. If the drone enters ATTI mode due to GPS failure or GPS signal interference, it will not be able to return. During the return process, strong headwinds may be encountered. Lowering the flight altitude appropriately can help reduce power consumption. If the power is insufficient, the drone will perform a forced landing in place. Please pay attention to the prompts in PotensicPro App. Do not initiate the return when there are obstacles overhead, such as tall trees, otherwise the drone may crash during the climb.

 Please pay attention to return safety, because the drone does not support obstacle avoidance and may crash when colliding with obstacles during the return course.

For any GPS signal anomaly in communication loss return, the drone will maintain hovering at ATTI mode, until GPS signal is strong enough and the return will resume.

» 7.9 Emergency Stop

See 5.3.1 Emergency stop for the detailed operation method.

⚠ Emergency stop function is designed for preventing injuring pedestrians or damaging the valuables by propeller blades in case of drone failure. Please use it with caution, because stopping the motors mid-flight will cause the drone to crash.

8. Calibration

This chapter mainly introduces the calibration-related functions in Settings, including compass calibration, gimbal calibration, gimbal fine-tuning, remote controller calibration, and drone re-pairing.

» 8.1 Compass Calibration

8.1.1 When to perform compass calibration

1. Before the first flight
2. Flying at a location farther than 50km (31miles) away from the location the drone was last flown

💡 Do not calibrate the compass in locations where magnetic interference may occur, such as close to magnetic deposits or large metallic structures such as parking structures, steel reinforced basements, bridges, cars, or scaffolding.

Keep away from other electronic device when calibrating, such as near to the mobile phone.

Make sure the drone is at least 1.5m (4.92ft) above the ground when calibrating.

It's not necessary to calibrate the compass when flying indoors.

8.1.2 Calibration Procedure

1. When calibration is required, the App will pop up the calibration interface automatically, tap "Start Calibration", and the drone status indicator will alternatively flash red and green.
2. Hold the drone horizontally and rotate it 360° till the App shows vertical calibration, and the drone status indicator will alternatively flash blue and green.
3. Hold the drone vertically and rotate it 360° around a vertical axis till the App prompts the calibration completed.

You can also trigger compass calibration manually in the App: Settings-Calibration-Compass Calibration.

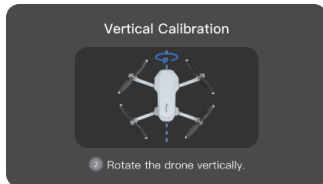
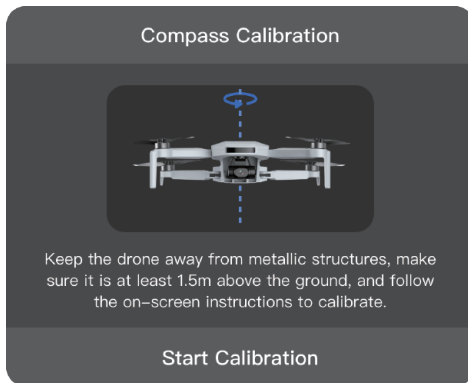

⚠ When you get the prompt "Calibration failed" in the App repeatedly, change the location and try the calibration procedure again.

⊘ Do not calibrate compass while arms are folded.

» 8.2 Gimbal Calibration

8.2.1 When to perform gimbal calibration

1. When the gimbal is not working or obviously unlevel after powering on and before take-off, please calibrate the gimbal.
2. When the gimbal is unstable or unable to stay level in flight, please land the drone and calibrate the gimbal.

8.2.2 Calibration Procedure

1. Tap Settings in the App, select "Gimbal Calibration", then place the drone on a level table with the bottom facing up.
2. Tap "Start Calibration", then calibrate, the live transmission view will appear on the calibration interface.
3. When the progress bar is fully loaded and the App prompts "Calibration Succeeded", the calibration is completed.



⚠ Do not move the drone significantly during the calibration process, otherwise the calibration may fail.

» 8.3 Gimbal Fine-tuning

The gimbal fine-tuning is for manually calibrating the gimbal, and adjusting the roll and yaw offset angle of the gimbal. You can tune the angle with reference to the status of the live transmission view on the App interface.

8.3.1 When to perform gimbal fine-tuning

When the gimbal is unable to stay level or slightly tilting on level ground.

8.3.2 How to use the Gimbal Fine-Tuning

1. Tap Settings in the App, select "Gimbal Fine-Tuning", then tune the roll and yaw angles of the gimbal with a range of $\pm 10^\circ$, you can tap "+/-" to adjust the gimbal angles or set the angle value directly, tap once means "+0.1°/-0.1°".
2. Gimbal Roll Adjustment: Tap "+" to roll to the right, and tap "-" to roll to the left.
Gimbal Yaw Adjustment: Tap "+" to yaw to the right, and tap "-" to yaw to the left.
3. Tap "Default Value" to restore the default angles (0°)

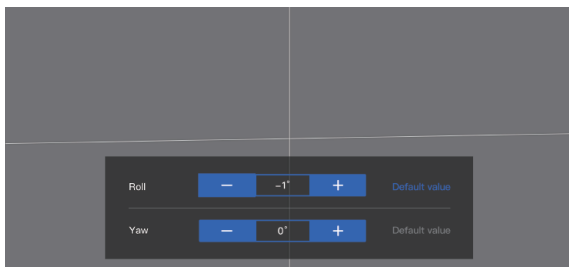

» 8.4 Remote Controller Calibration

8.4.1 When to perform remote controller calibration

1. When the drone drifts automatically in one direction without any toggling of the control sticks.
2. When the gimbal auto-rotating sideways continuously.
3. When the control sticks are over-sensitive or lack sensitivity.

8.4.2 Calibration Procedure

1. Turn on the remote controller, and connect the mobile device, tap Settings in the App, select "Remote Controller Calibration".
2. Make sure the control sticks are in the middle position and do not operate it before tapping to start the calibration.
3. Tap "Start Calibration", then follow the on-screen instructions and toggle the sticks in all directions until 100% is displayed in the app interface, and then maximum toggle the Dial back and forth.
4. When App prompts "Calibration Succeeded", the remote controller calibration is completed.

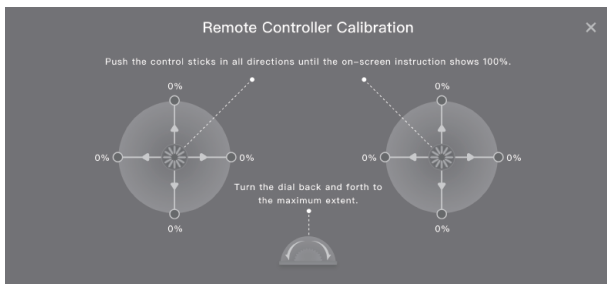
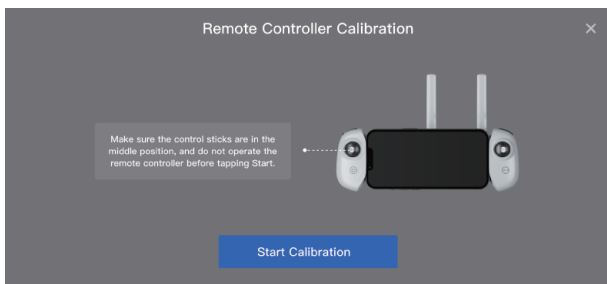

» 8.5 Drone Re-pairing

8.5.1 When to perform drone re-pairing

Drone re-pairing is required if you replace the drone or remote controller.

8.5.2 Drone Re-pairing Procedure

1. Turn on the remote controller, and connect the mobile device, tap Settings in the App, select "Calibration", tap "Re-pairing the drone" to re-pair.
2. Power on the drone and long press the power button till the drone status indicators flash green, the drone is ready to pairing.
3. Wait for about 7s, the pairing succeeds when the controller beeps "Di", then you can view the live transmission on the App interface.

 Make sure the distance between the remote controller and the drone is within 1m (3.3ft) and away from other 2.4G frequency interference during the frequency pairing process.

If the pairing has failed, please check if there is any interference from the current location, if any other drones are under pairing, or if the distance is too far between the remote controller and the drone or any blocks between them. If none of the above, please try the pairing procedures again.

Do not move or operate the drone and controller during the frequency pairing process.



9. Appendix

» 9.1 Specification & Parameters

Drone

Model: DSDR04C

Takeoff Weight: < 249g (the takeoff weight includes battery and propeller blades)

Folded Size: 88x143x58mm

Unfolded Size (propeller blades included): 300x242x58mm

Unfolded Size (propeller blades excluded): 210x152x58mm

Diagonal Distance: 219mm

Max Speed (Sport Mode): Ascent speed: 5m/s; Descent speed: 4m/s; Flight speed: 16m/s

Max Wind Speed Resistance: 38km/h (Level 5)

Maximum Flight Altitude: 120m/393.7ft

GNSS: GPS+GLONASS+Galileo+BeiDou

Operating Temperature: 0°C~40°C

Operating Frequency: 2.400~2.4835GHz

Transmission Power: 2.4GHz: < 24dBm

Hovering Accuracy Range: Vertical: ± 0.1 m (with Vision Positioning), ± 0.5 m (with GPS Positioning)

Horizontal Flight: ± 0.3 m (with Vision Positioning), ± 1.5 m (with GPS Positioning)

Extra Payload: Not supported

Max Flight Time: 32min (measured at breezeless condition and even speed of 5m/s)

Downward Vision System

Hovering range: 0.3~5m(ideal environment); Available at 0.3~10m.

Unavailable scenarios of vision positioning:

1. Pure-color surface
2. Surface with strong reflection, such as smooth metal surface
3. Transparent object surface, such as water surface and glass
4. Moving texture, such as running pets

5. Scenarios with drastic change of light; for example, the drone flies to outdoor space with strong light from indoor space
 6. The places with weak or strong light
 7. The surface with repeating identical patterns or textures, such as floor tile with the same texture and size
 8. The surface with highly consistent strip pattern
-

Camera

Lens Tilt Range: +20°--90°

CMOS: 1/3"

Effective Pixel: 12MP

ISO Range: 100-6400

Electronic Shutter Speed: 1/24s~1/25000s

FOV: 78°

Aperture: F2.2

Photo Resolution: 4608*2592

Image Format: JPG/JPG+RAW(DNG)

Video Resolution: 4K@30/25/24fps; 2.7K@30/25/24fps; 1080P@60/50/30/25/24fps

Video Format: MP4 (H.264)

Max Video Bitrate: 50Mbps

Supported File System: FAT 32, exFAT

Type Of Supported Storage Card: MicroSD card; 4~256GB SD card transmission speed ≥class10 or U1 standard

Remote Controller

Model: DSRC02A

Operation Frequency: 2.402~2.483GHz

Max Transmission Distance (unobstructed, free of interference): 6km

Operating Temperature: 0°C~40°C

Battery: 3000mAh, lithium battery, 1S

Transmitter Power (EIRP): 2.4GHz: ≤20dBm

Charging Interface: TYPE-C

Charging Specification: 5V/1A

Video Transmission System: PixSync 3.0™

Video Transmission Quality: 720P

Latency (depending on environment and mobile device): 200ms

Supported Mobile Device Size: Length: 170mm, Width: 100mm, Thickness: 6.5mm~8.5mm

Smart Flight Battery

Model: DSBT02B

Capacity: 2230mAh

Voltage: 7.7V

Battery Type: Li-Po 2S

Energy: 17.18Wh

Battery Weight: 84g

Working Temperature: 0°C~40°C



WARNING

**DANGER**Only suitable
for ages 14+

Warning: The product should only be used by adults and children over 14 years. Adult supervision is required for children under 14 years.

Hinweis: Dieses Produkt ist für die Erwachsene und die Kinder ab 14 Jahren. Die Kinder unter 14 Jahren müssen von Erwachsenen beaufsichtigt werden.

Avertissement: Ce produit est destiné aux adultes et aux enfants de plus de 14 ans. Les enfants de moins de 14 ans doivent être surveillés par des adultes.

Avvertimento: Questo prodotto è destinato all'uso per i adulti e bambini di età superiore ai 14 anni. I bambini di età inferiore ai 14 anni devono essere sorvegliati da un adulto.

Advertencia: Este producto es para adultos y niños mayores de 14 años. Los niños menores de 14 años deben ser supervisados por adultos.

警告: この製品は、大人と14歳以上の子供には使用対象です。14歳未満の子供は大人の監視が必要です。



صنعت وفقاً للمواصفات والمعايير العالمية
Tested according to international standards

**WARNING:**NOT SUITABLE FOR
CHILDREN UNDER 3 YEARS
DUE TO SMALL PARTS

هتدار ابرى كود كان زير 3 سال
مسابست نيست . دارى قطعات كوچك است
تحتوي : عمر ملاح تلغرافى تحت ثلاثة (3) سنوات بسبب
لقطعة الصغيرة
COUNTRY OF ORIGIN: CHINA
بلد المنشأ: الصين

**WARNING:****CHOKING HAZARD—Small parts.**
Not for children under 3 years.**Drone FCC ID: 2AYUO-DSDR04B****Remote controller FCC ID: 2AYUO-DSRC02A**

Changes or modifications not expressly Approved by the party responsible for compliance could void the user's authority to operate the equipment.

This device complies with Part 15 of the FCC Rules. Operation is subject to the following two conditions:

- (1) This device may not cause harmful interference, and
- (2) This device must accept any interference received, including interference that may cause undesired operation.

Note: This equipment has been tested and found to comply with the limits for a Class B digital device, pursuant to Part 15 of the FCC Rules. These limits are designed to provide reasonable protection against harmful interference in a residential installation. This equipment generates, uses, and can radiate radio frequency energy, and if not installed and used in accordance with the instructions, may cause harmful interference to radio communications. However, there is no guarantee that interference will not occur in a particular installation. If this equipment does cause harmful interference to radio or television reception, which can be determined by turning the equipment off and on, the user is encouraged to try to correct the interference by one or more of the following measures:

- Reorient or relocate the receiving antenna.
- Increase the separation between the equipment and receiver.
- Connect the equipment into an outlet on a circuit different from that to which the receiver is connected.
- Consult the dealer or an experienced radio/TV technician for help.

This equipment complies with FCC radiation exposure limits set forth for an uncontrolled environment. This equipment should be installed and operated with a minimum distance of 20cm between the radiator & your body. This transmitter must not be co-located or operating in conjunction with any other antenna or transmitter.

Manufacturer: Shenzhen Deepsea Excellence Technology Co., Ltd.**Address:** 5th Floor, Building 7, Hongfa High-tech Park, Keji 4th Road,
Shiyan Street, Baoan District, Shenzhen**EC REP:** E-CrossStu GmbH. Mainzer Landstr.69,60329 Frankfurt am Main**UK REP:** DST Co.,Ltd. Fifth Floor 3 Gower Street, London, WC1E 6HA, UK

R 214-113197

**MADE IN CHINA**