



# Operator Manual

## **Generator Set with QSJ5.9G Engine and PowerCommand® 1.1 Control**

C45 N6 (Spec A)  
C50 N6 (Spec A)  
C60 N6 (Spec A)  
C70 N6 (Spec A)  
C80 N6 (Spec A)  
C100 N6 (Spec A)

**California**

**Proposition 65 Warning**

The engine exhaust from this product contains chemicals known to the State of California to cause cancer, birth defects, or other reproductive harm.

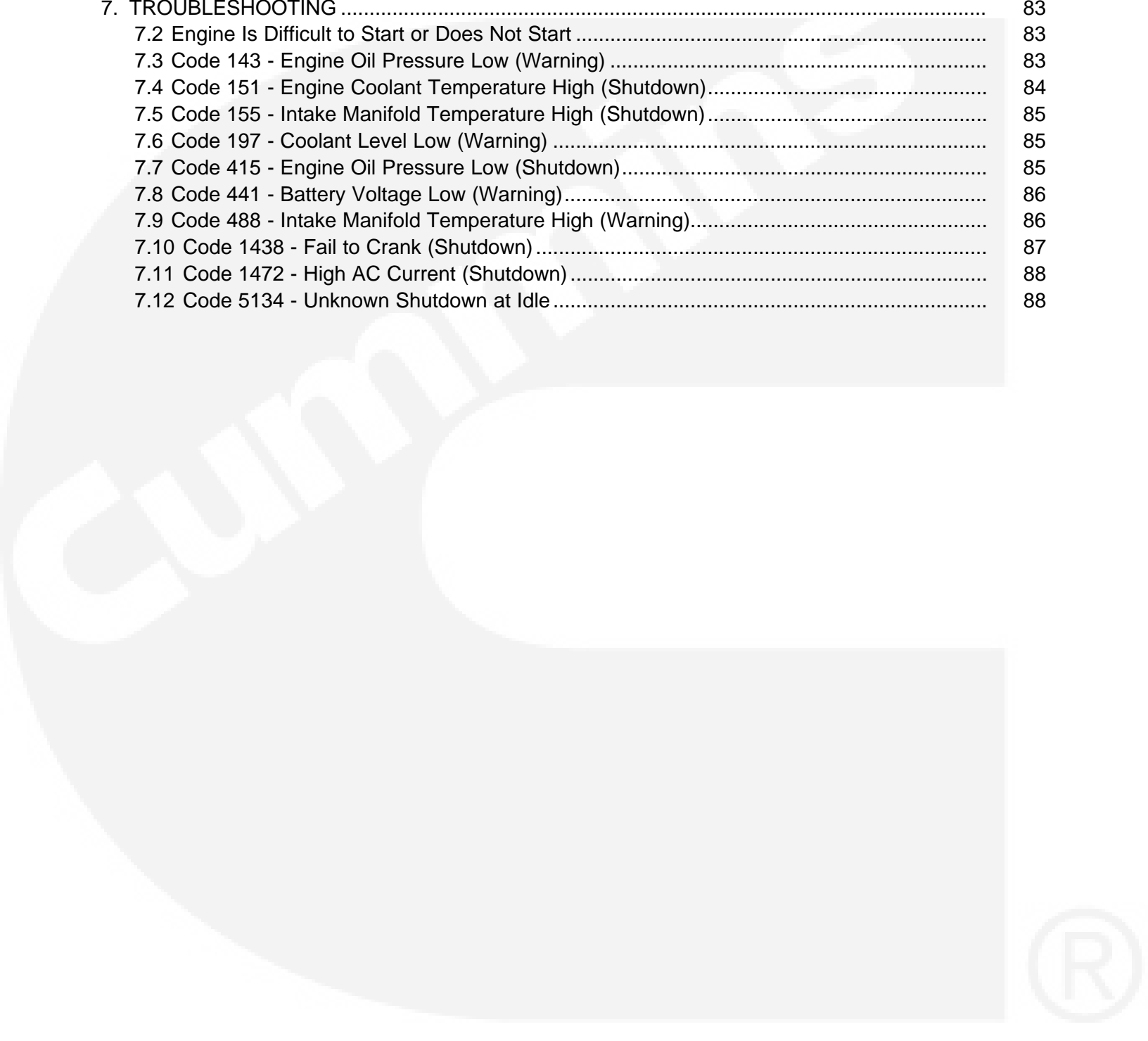
# Table of Contents

---

1. IMPORTANT SAFETY INSTRUCTIONS .....	1
1.1 Warning, Caution, and Note Styles Used in This Manual .....	1
1.2 General Information .....	1
1.3 Generator Set Safety Code .....	4
1.4 Batteries Can Explode .....	4
1.5 Moving Parts Can Cause Severe Personal Injury or Death .....	5
1.6 Electrical Shocks and Arc Flashes Can Cause Severe Personal Injury or Death.....	6
1.7 Fuel and Fumes Are Flammable .....	6
1.8 Exhaust Gases Are Deadly.....	7
1.9 The Hazards of Carbon Monoxide.....	8
1.10 Earth Ground Connection .....	9
2. INTRODUCTION.....	11
2.1 About This Manual.....	11
2.2 Schedule of Abbreviations .....	12
2.3 Related Literature .....	14
2.4 Model Specifications .....	15
2.5 After Sales Services.....	19
2.6 General Operating Conditions .....	20
2.7 Generator Set Nameplate .....	21
3. MANUFACTURING FACILITIES.....	23
4. CONTROL SYSTEM.....	25
4.1 Control System Description .....	25
4.2 Display Text or Symbolic Version.....	29
4.3 Exercise Settings .....	30
4.4 Brightness and Contrast .....	38
4.5 History and About Menu .....	40
4.6 Fault Log.....	42
4.7 Selecting Operating Modes.....	44
4.8 Operating Modes .....	49
5. OPERATION - POWERCOMMAND 1.1 .....	51
5.1 Introduction .....	51
5.2 General Operating Conditions .....	51
5.3 Generator Set Operation.....	51
6. MAINTENANCE .....	63
6.1 Maintenance Safety .....	63
6.2 Periodic Maintenance .....	65
6.3 Exercising the Generator Set .....	70
6.4 Engine Oil .....	71

---

6.5 Air Intake System.....	76
6.6 Batteries.....	78
6.7 Spark Plugs .....	82
7. TROUBLESHOOTING .....	83
7.2 Engine Is Difficult to Start or Does Not Start .....	83
7.3 Code 143 - Engine Oil Pressure Low (Warning) .....	83
7.4 Code 151 - Engine Coolant Temperature High (Shutdown).....	84
7.5 Code 155 - Intake Manifold Temperature High (Shutdown).....	85
7.6 Code 197 - Coolant Level Low (Warning) .....	85
7.7 Code 415 - Engine Oil Pressure Low (Shutdown).....	85
7.8 Code 441 - Battery Voltage Low (Warning).....	86
7.9 Code 488 - Intake Manifold Temperature High (Warning).....	86
7.10 Code 1438 - Fail to Crank (Shutdown) .....	87
7.11 Code 1472 - High AC Current (Shutdown).....	88
7.12 Code 5134 - Unknown Shutdown at Idle.....	88



# 1 Important Safety Instructions

---

Save these instructions. This manual contains important instructions that should be followed during installation and maintenance of the generator set.

Safe and efficient operation can be achieved only if the equipment is properly operated and maintained. Many accidents are caused by failure to follow fundamental rules and precautions.

## 1.1 Warning, Caution, and Note Styles Used in This Manual

The following safety styles and symbols found throughout this manual indicate potentially hazardous conditions to the operator, service personnel, or equipment.

### DANGER

*Indicates a hazardous situation that, if not avoided, will result in death or serious injury.*

### WARNING

*Indicates a hazardous situation that, if not avoided, could result in death or serious injury.*

### CAUTION

*Indicates a hazardous situation that, if not avoided, could result in minor or moderate injury.*

### NOTICE

Indicates information considered important, but not hazard-related (e.g., messages relating to property damage).

## 1.2 General Information

This manual should form part of the documentation package supplied by Cummins Power Generation with specific generator sets. In the event that this manual has been supplied in isolation please contact your authorized dealer.

### NOTICE

**It is in the operator's interest to read and understand all warnings and cautions contained in the documentation relevant to the generator set operation and daily maintenance.**

## General Safety Precautions

### WARNING

#### ***Hot Pressurized Liquid***

***Contact with hot liquid can cause severe burns.***

***Do not open the pressure cap while the engine is running. Let the engine cool down before removing the cap. Turn the cap slowly and do not open it fully until the pressure has been relieved.***

### WARNING

#### ***Moving Parts***

***Moving parts can cause severe personal injury.***

***Use extreme caution around moving parts. All guards must be properly fastened to prevent unintended contact.***

### WARNING

#### ***Toxic Hazard***

***Used engine oils have been identified by some state and federal agencies to cause cancer or reproductive toxicity.***

***Do not ingest, breathe the fumes, or contact used oil when checking or changing engine oil. Wear protective gloves and face guard.***

### WARNING

#### ***Electrical Generating Equipment***

***Incorrect operation and maintenance can result in severe personal injury or death.***

***Do not operate equipment when fatigued, or after consuming any alcohol or drug.***

***Make sure that only suitably trained and experienced service personnel perform electrical and/or mechanical service.***

### WARNING

#### ***Toxic Gases***

***Substances in exhaust gases have been identified by some state and federal agencies to cause cancer or reproductive toxicity.***

***Do not breathe in or come into contact with exhaust gases.***

### WARNING

#### ***High Noise Level***

***Generator sets in operation emit noise, which can cause hearing damage.***

***Wear appropriate ear protection at all times.***

**⚠ WARNING****Hot Surfaces**

**Contact with hot surfaces can cause severe burns.**

**Wear appropriate PPE when working on hot equipment and avoid physical contact with hot surfaces.**

**⚠ WARNING****Toxic Hazard**

**Ethylene glycol, used as an engine coolant, is toxic to humans and animals.**

**Wear appropriate PPE. Clean up coolant spills and dispose of used coolant in accordance with local environmental regulations.**

**⚠ WARNING****Combustible Liquid**

**Ignition of combustible liquids is a fire or explosion hazard which can cause severe burns or death.**

**Do not store fuel, cleaners, oil, etc., near the generator set. Do not use combustible liquids like ether.**

**⚠ WARNING****Combustible Gases**

**Generator sets in operation have combustible gases under pressure, which if ignited can cause eye and ear damage.**

**Wear appropriate eye and ear protection at all times.**

**⚠ WARNING****Combustible Gases**

**Generator sets in operation have combustible gases under pressure, which if ignited can cause severe injury.**

**Do not operate the generator set with any doors open.**

**⚠ WARNING****Fire Hazard**

**Materials drawn into the generator set, as well as accumulated grease and oil, are a fire hazard. Fire can cause severe burns or death.**

**Keep the generator set and the surrounding area clean and free from obstructions. Make sure the generator set is mounted in a manner to prevent combustible materials from accumulating under the unit.**

**⚠ WARNING*****Automated Machinery***

***Accidental or remote starting of the generator set can cause severe personal injury or death.***

***Isolate all auxiliary supplies and use an insulated wrench to disconnect the starting battery cables (negative [-] first).***

**NOTICE**

Keep multi-class ABC fire extinguishers handy. Class A fires involve ordinary combustible materials such as wood and cloth. Class B fires involve combustible and flammable liquid fuels and gaseous fuels. Class C fires involve live electrical equipment. (Refer to NFPA No. 10 in applicable region.)

**NOTICE**

Before performing maintenance and service procedures on enclosed generator sets, make sure the service access doors are secured open.

**NOTICE**

Stepping on the generator set can cause parts to bend or break, leading to electrical shorts, or to fuel, coolant, or exhaust leaks. Do not step on the generator set when entering or leaving the generator room.

## 1.3 Generator Set Safety Code

Before operating the generator set, read the manuals and become familiar with them and the equipment. **Safe and efficient operation can be achieved only if the equipment is properly operated and maintained.** Many accidents are caused by failure to follow fundamental rules and precautions.

**⚠ WARNING*****Electrical Generating Equipment***

***Incorrect operation and maintenance can result in severe personal injury or death.***

***Read and follow all Safety Precautions, Warnings, and Cautions throughout this manual and the documentation supplied with the generator set.***

## 1.4 Batteries Can Explode

Batteries can explode, causing severe skin and eye burns and can release toxic electrolytes.



**⚠ WARNING****Combustible Gases**

**Batteries can explode, causing severe skin and eye burns, and can release toxic electrolytes.**

**Do not dispose of the battery in a fire, because it is capable of exploding. Do not open or mutilate the battery.**

**⚠ WARNING****Electric Shock Hazard**

**Batteries present the risk to high short circuit current.**

**Remove watches, rings, or other metal objects. Use tools with insulated handles.**

- Wear safety glasses.
- Do not smoke.
- To prevent arcing when disconnecting the battery:
  1. Press the Stop Switch.
  2. Disconnect AC power from any battery chargers.
  3. Remove the negative (-) battery cable to prevent starting.
- To prevent arcing when reconnecting the battery:
  1. Reconnect the positive (+) cable.
  2. Reconnect the negative (-) cable.
  3. Reconnect the battery charger to AC power supply.
- When replacing the generator set battery, always replace it with a battery as specified in this manual.

## 1.5 Moving Parts Can Cause Severe Personal Injury or Death

- Keep hands, clothing, and jewelry away from moving parts.
- Before starting work on the generator set, disconnect the battery charger from its AC source, then disconnect the starting batteries using an insulated wrench, negative (-) cable first. This will prevent accidental starting.
- Make sure that fasteners on the generator set are secure. Tighten supports and clamps; keep guards in position over fans, drive belts, etc.
- Do not wear loose clothing or jewelry in the vicinity of moving parts or while working on electrical equipment. Loose clothing and jewelry can become caught in moving parts.
- If any adjustments must be made while the unit is running, use extreme caution around hot manifolds, moving parts, etc.

## 1.6 Electrical Shocks and Arc Flashes Can Cause Severe Personal Injury or Death

- Only qualified service personnel certified and authorized to work on power circuits should work on exposed energized power circuits.
- All relevant service material must be available for any electrical work performed by certified service personnel.
- Exposure to energized power circuits with potentials of 50 VAC or 75 VDC or higher poses a significant risk of electrical shock and electrical arc flash.
- Refer to standard NFPA 70E, or equivalent safety standards in corresponding regions, for details of the dangers involved and for safety requirements.

## 1.7 Fuel and Fumes Are Flammable

Fire, explosion, and personal injury or death can result from improper practices.

- Do not fill fuel tanks while the engine is running unless the tanks are outside the engine compartment. Fuel contact with hot engine or exhaust is a potential fire hazard.
- Do not permit any flame, cigarette, pilot light, spark, arcing equipment, or other ignition source near the generator set or fuel tank.
- Fuel lines must be adequately secured and free of leaks. Fuel connection at the engine should be made with an approved flexible line. Do not use copper piping on flexible lines as copper will become brittle if continuously vibrated or repeatedly bent.
- Make sure all fuel supplies have a positive shutoff valve.
- Make sure the battery area has been well-ventilated prior to servicing near it. Lead-acid batteries emit a highly explosive hydrogen gas that can be ignited by arcing, sparking, smoking, etc.

### **Do Not Operate in Flammable and Explosive Environments**

Flammable vapor can cause an engine to over speed and become difficult to stop, resulting in possible fire, explosion, severe personal injury, and death. Do not operate a generator set where a flammable vapor environment can be created, unless the generator set is equipped with an automatic safety device to block the air intake and stop the engine. The owners and operators of the generator set are solely responsible for operating the generator set safely. Contact your authorized Cummins Power Generation distributor for more information.

### **Spillage**

Any spillage that occurs during fueling or during oil top-off or oil change must be cleaned up before starting the generator set.

## Fluid Containment

### NOTICE

**Where spillage containment is not part of a Cummins supply, it is the responsibility of the installer to provide the necessary containment to prevent contamination of the environment, especially water courses and sources.**

If fluid containment is incorporated into the bedframe, it must be inspected at regular intervals. Any liquid present should be drained out and disposed of in line with local health and safety regulations. Failure to perform this action may result in spillage of liquids which could contaminate the surrounding area.

Any other fluid containment area must also be checked and emptied, as described above.

## 1.8 Exhaust Gases Are Deadly

- Provide an adequate exhaust system to properly expel discharged gases away from enclosed or sheltered areas, and areas where individuals are likely to congregate. Visually and audibly inspect the exhaust system daily for leaks per the maintenance schedule. Make sure that exhaust manifolds are secured and not warped. Do not use exhaust gases to heat a compartment.
- Make sure the unit is well ventilated.

### Exhaust Precautions

#### ⚠ WARNING

##### ***Hot Exhaust Gases***

***Contact with hot exhaust gases can cause severe burns.***

***Wear personal protective equipment when working on equipment.***

#### ⚠ WARNING

##### ***Hot Surfaces***

***Contact with hot surfaces can cause severe burns.***

***Wear appropriate PPE when working on hot equipment and avoid physical contact with hot surfaces.***

#### ⚠ WARNING

##### ***Toxic Gases***

***Inhalation of exhaust gases can cause asphyxiation and death.***

***Pipe exhaust gas outside and away from windows, doors, or other inlets to buildings. Do not allow exhaust gas to accumulate in habitable areas.***

**⚠ WARNING****Fire Hazard**

**Contaminated insulation is a fire hazard. Fire can cause severe burns or death.**

**Remove any contaminated insulation and dispose of it in accordance with local regulations.**

The exhaust outlet may be sited at the top or bottom of the generator set. Make sure that the exhaust outlet is not obstructed. Personnel using this equipment must be made aware of the exhaust position. Position the exhaust away from flammable materials - in the case of exhaust outlets at the bottom, make sure that vegetation is removed from the vicinity of the exhaust.

The exhaust pipes may have some insulating covers fitted. If these covers become contaminated they must be replaced before the generator set is run.

To minimize the risk of fire, make sure the following steps are observed:

- Make sure that the engine is allowed to cool thoroughly before performing maintenance or operation tasks.
- Clean the exhaust pipe thoroughly.

## 1.9 The Hazards of Carbon Monoxide

Carbon Monoxide (CO) is an odorless, colorless, tasteless and non-irritating gas (you cannot see it or smell it). Exposure even to low levels of CO for a prolonged period can lead to asphyxiation (lack of Oxygen), resulting in death. Mild effects of CO poisoning include eye irritation, dizziness, headaches, fatigue, and the inability to think clearly. More extreme symptoms include vomiting, seizures, and collapse.

Engine-driven generators produce harmful levels of carbon monoxide that can injure or kill you.

### What Is Carbon Monoxide Poisoning?

Carbon Monoxide (CO) is an odorless, colorless, tasteless and non-irritating gas. You cannot see it or smell it. Red blood cells, however, have a greater affinity for CO than for Oxygen. Therefore, exposure even to low levels of CO for a prolonged period can lead to asphyxiation (lack of Oxygen) resulting in death. Mild effects of CO poisoning include eye irritation, dizziness, headaches, fatigue and the inability to think clearly. More extreme symptoms include vomiting, seizures and collapse.

## Special Risks of CO Near the Home

### WARNING

#### **Toxic Gases**

***Carbon monoxide (CO) gas can cause nausea, fainting, or death. Residents can be exposed to lethal levels of CO when the generator set is running. Depending on air temperature and wind, CO can accumulate in or near the home.***

***To protect yourself and others from the dangers of CO poisoning, it is recommended that reliable, approved, and operable CO detector alarms are installed in proper locations in the home as specified by their manufacturer.***

## Protecting Yourself from CO Poisoning

- Locate the generator in an area where there are no windows, doors, or other access points into the home.
- Make sure all CO detectors are installed and working properly.
- Pay attention for signs of CO poisoning.
- Check the exhaust system for corrosion, obstruction, and leaks every time you start the generator set and every eight hours when you run it continuously.

## 1.10 Earth Ground Connection

The neutral of the generator set may be required to be bonded to earth ground at the generator set location, or at a remote location, depending on system design requirements. Consult the engineering drawings for the facility or a qualified electrical design engineer for proper installation.

### NOTICE

**The end user is responsible to make sure that the ground connection point surface area is clean and free of rust before making a connection.**

### NOTICE

**The end user is responsible for making sure that an earthing arrangement that is compliant with local conditions is established and tested before the equipment is used.**



This page is intentionally blank.



## 2 Introduction

---

### WARNING

#### ***Hazardous Voltage***

***Contact with high voltages can cause severe electrical shock, burns, or death.***

***Make sure that only a trained and experienced electrician makes generator electrical output connections, in accordance with the installation instructions and all applicable codes.***

### WARNING

#### ***Electrical Generating Equipment***

***Faulty electrical generating equipment can cause severe personal injury or death.***

***Generator sets must be installed, certified, and operated by trained and experienced person in accordance with the installation instructions and all applicable codes.***

## 2.1 About This Manual

The purpose of this manual is to provide the users with sound, general information. It is for guidance and assistance with recommendations for correct and safe procedures. Cummins Power Generation (CPG) cannot accept any liability whatsoever for problems arising as a result of following recommendations in this manual.

The information contained within the manual is based on information available at the time of going to print. In line with Cummins Power Generation policy of continuous development and improvement, information may change at any time without notice. The users should therefore make sure that they have the latest information available before starting any work. The latest version of this manual is available on QuickServe Online (<https://qsol.cummins.com/info/index.html>).

Users are respectfully advised that, in the interests of good practice and safety, it is their responsibility to employ competent people to carry out any installation work. Consult your authorized dealer for further installation information. It is essential that the utmost care is taken with the application, installation, and operation of any engine due to their potentially hazardous nature. Careful reference should also be made to other Cummins Power Generation literature. You must operate and maintain your generator set properly if you are to expect safe and reliable operation.

For further assistance, contact your authorized dealer.

**NOTICE**

This device complies with part 15 of the FCC rules. Operation is subject to the following two conditions:

- This device may not cause harmful interferences.
- This device must accept any interference received, including interference that may cause undesired operation.

## 2.2 Schedule of Abbreviations

This list is not exhaustive. For example, it does not identify units of measure or acronyms that appear only in parameters, event/fault names, or part/accessory names.

AmpSentry, INSITE, and InPower are trademarks of Cummins Inc. PowerCommand is a registered trademark of Cummins Inc.

ABBR.	DESCRIPTION	ABBR.	DESCRIPTION
AC	Alternating Current	LED	Light-emitting Diode
AMP	AMP, Inc., part of Tyco Electronics	LTS	Long Term Storage
ANSI	American National Standards Institute	LVRT	Low Voltage Ride Through
ASOV	Automatic Shut Off Valve	MFM	Multifunction Monitor
ASTM	American Society for Testing and Materials (ASTM International)	Mil Std	Military Standard
ATS	Automatic Transfer Switch	MLD	Masterless Load Demand
AVR	Automatic Voltage Regulator	NC	Normally Closed
AWG	American Wire Gauge	NC	Not Connected
CAN	Controlled Area Network	NFPA	National Fire Protection Agency
CB	Circuit Breaker	NO	Normally Open
CE	Conformité Européenne	NWF	Network Failure
CFM	Cubic Feet per Minute	OEM	Original Equipment Manufacturer
CGT	Cummins Generator Technologies	OOR	Out of Range



<b>ABBR.</b>	<b>DESCRIPTION</b>	<b>ABBR.</b>	<b>DESCRIPTION</b>
CMM	Cubic Meters per Minute	OORH / ORH	Out of Range High
CT	Current Transformer	OORL / ORL	Out of Range Low
D-AVR	Digital Automatic Voltage Regulator	PB	Push Button
DC	Direct Current	PCC	PowerCommand® Control
DEF	Diesel Exhaust Fluid	PGI	Power Generation Interface
DPF	Diesel Particulate Filter	PGN	Parameter Group Number
ECM	Engine Control Module	PI	Proportional/Integral
ECS	Engine Control System	PID	Proportional/Integral/Derivative
EMI	Electromagnetic interference	PLC	Programmable Logic Controller
EN	European Standard	PMG	Permanent Magnet Generator
EPS	Engine Protection System	PPE	Personal Protective Equipment
E-Stop	Emergency Stop	PT	Potential Transformer
FAE	Full Authority Electronic	PTC	Power Transfer Control
FMI	Failure Mode Identifier	PWM	Pulse-width Modulation
FRT	Fault Ride Through	RFI	Radio Frequency Interference
FSO	Fuel Shutoff	RH	Relative Humidity
Genset	Generator Set	RMS	Root Mean Square
GCP	Generator Control Panel	RTU	Remote Terminal Unit
GND	Ground	SAE	Society of Automotive Engineers
LCT	Low Coolant Temperature	SCR	Selective Catalytic Reduction
HMI	Human-machine Interface	SPN	Suspect Parameter Number
IC	Integrated Circuit	SWL	Safe Working Load
ISO	International Organization for Standardization	SW_B+	Switched B+

ABBR.	DESCRIPTION	ABBR.	DESCRIPTION
LBNG	Lean-burn Natural Gas	UL	Underwriters Laboratories
LCD	Liquid Crystal Display	UPS	Uninterruptible Power Supply

## 2.3 Related Literature

Before any attempt is made to operate the generator set, the operator should take time to read all of the manuals supplied with the generator set, and to familiarize themselves with the warnings and operating procedures.

The literature provided with the generator set is as follows:

- Operator Manual (A051X877)
- Installation Manual (A051X873)

### NOTICE

**A generator set must be operated and maintained properly if you are to expect safe and reliable operation. The Operator manual includes a maintenance schedule and a troubleshooting guide.**

**The Health and Safety manual must be read in conjunction with this manual for the safe operation of the generator set:**

- **Health and Safety Manual (0908-0110)**
- **Warranty Statement (A028U870)**
- ***C45 N6, C50 N6 and C60 N6 models only: Emissions Component Defect Warranty Statement (A028X278)***
- ***C70 N6, C80 N6 and C100 N6 models only: Emissions Component Defect Warranty Statement (A028X279)***

The relevant manuals appropriate to your generator set are also available. The documents below are in English:

- Service Manual (A051X880)
- Parts Manual (A051X891)
- EControls, Inc., Global Control Platform (GCP) Software Service Manual (A035C596)
- EControls, Inc., 4G Software Service Manual (A052G032)
- EControls, Inc., GCP Engine Display Interface Software (EDIS) Training Manual (A035C608)
- EControls, Inc., 4G Software Operator Manual (A052G024)
- Engine Operation & Maintenance Manual for QSJ5.9G (4388606)
- RA Series Transfer Switch Owner Manual (A046S594) - if applicable

- PowerCommand® 1302 Controller Owner's Manual (900-0661)
- Service Tool Manual (A043D529)
- Standard Repair Times - HL Family (A053K365)
- T-030: Liquid Cooled Generator Set Application Manual (A040S369) - for application information

## 2.4 Model Specifications

### NOTICE

Damage caused by failure to follow the manufacturer's recommendation will not be covered by the warranty. Please contact your authorized distributor.

TABLE 1. 5.9L MODEL VARIATIONS

Models	Description
C45 N6, C50 N6, C60 N6, C70 N6, C80 N6, C100 N6	60 Hz, 1800 RPM

TABLE 2. COLD WEATHER SPECIFICATIONS (ALL MODELS)

Temperature	Description	Battery Type	Group
Above 40 °F (4 °C)	Battery charger	Standard	34
0 to 40 °F (-17 to 4 °C)	Battery charger, coolant heater (1000W), CCV heater <sup>1</sup>	Standard	34
Below 0 °F (-17 °C)	Battery charger, coolant heater (1500W), oil heater, battery heater, CCV heater <sup>1</sup> , cold weather starter <sup>2</sup>	Larger	4D

<sup>1</sup>CCV heaters are provided as part of the cold and extreme cold coolant heater packages.

<sup>2</sup>The cold weather starter is provided as part of the extreme cold coolant heater package.

### NOTICE

For NFPA 110 applications, a coolant heater is required. A factory option is available.

**TABLE 3. FUEL SPECIFICATIONS 60 HZ, 1800 RPM**

Type	Unit	C45 N6	C50 N6	C60 N6	C70 N6	C80 N6	C100 N6
Liquid Propane Full Load	scfh	289.6	321.6	370.2	384.2	420.8	518.7
	BTU/hr	651,600	723,600	832,950	864,450	946,800	1,167,075
Natural Gas Full Load	scfh	711.2	806.3	933.8	988.4	1,083.5	1,317.7
	BTU/hr	721,868	818,395	947,807	1,003,226	1,099,753	1,337,466
Fuel Pressure	<i>Minimum:</i> 6 inches water column (1.5 kPa) <i>Maximum:</i> 14 inches water column (3.5 kPa)						

**TABLE 4. ENGINE SPECIFICATIONS (ALL MODELS)**

Type	Specification
Engine	6 cylinder-in-line, single-cam, liquid-cooled, 4-stroke, spark ignited
Bore	4.02 in (102 mm)
Stroke	4.72 in (120 mm)
Displacement	359 in <sup>3</sup> (5.88 L)
Compression Ratio (Natural Gas & LPG)	8.5:1
Firing Order	1-5-3-6-2-4
Spark Plug Gap 45, 50, 60 kW)	0.020 in (0.508 mm)
Spark Plug Gap (70, 80, 100 kW)	0.016 in (0.40 mm)
Spark Plug Torque	28 ft-lb (38 Nm)
Crankshaft Rotation (Viewed from the Front of the Engine)	Clockwise
Engine Weight (Dry, Long Block Only)	911 lb (413 kg)
Valve Clearance (Intake)	0.012 in (0.305 mm)
Valve Clearance (Exhaust)	0.024 in (0.610 mm)
Coolant	<ul style="list-style-type: none"> <li>• 50/50 coolant solution (50% pure water and 50% anti-freeze)</li> <li>• 4.23 gallons (16 L) capacity</li> </ul>
Oil Capacity	4 gallons (15 L)

Type	Specification
Oil Standards	<ul style="list-style-type: none"> <li>• Must adhere to Cummins® Engineering Standard (CES) 20074</li> <li>• Use of improper oils can result in engine damage. Use only the required oils: <ul style="list-style-type: none"> <li>◦ 5W-40 (all ambient temperatures)</li> <li>◦ 15W-40 (<b>above</b> 40 °F [4 °C] ambient temperature) (use of GEO 15W-40 oil in ambient temperatures <b>below</b> 40 °F [4 °C] could result in engine turbocharger damage)</li> </ul> </li> <li>• A sulfated ash limit of 0.6% mass has been placed on all engine lubricating oils recommended for use in Cummins® B, natural gas engines. Higher ash oils can cause valve and/or piston damage, cause spark plug fouling, and lead to excessive oil consumption and degradation of the catalyst.</li> </ul>

TABLE 5. GENERATOR SET SIZE SPECIFICATIONS

Enclosure Type	Size (L x W x H)
Open/Weather	98 x 40 x 58 in (2489 x 1016 x 1473 mm); does not include exhaust discharge elbow
Sound Level 1	119 x 40 x 58 in (3023 x 1016 x 1473 mm)
Sound Level 2	136 x 40 x 58 in (3454 x 1016 x 1473 mm)

TABLE 6. GENERATOR SET WET WEIGHT (POUNDS) (60 HZ, 1800 RPM)

Configuration	C45 N6	C50 N6	C60 N6	C70 N6	C80 N6	C100 N6
Open	2180	2180	2431	2449	2587	2719
Weather	2359	2359	2610	2628	2766	2898
Sound Level 1	2455	2455	2706	2724	2862	2994
Sound Level 2	2485	2485	2736	2754	2892	3024

**NOTICE**

**Weights are approximate and can be affected by selected options. Refer to outline drawings for specific weight information.**

**TABLE 7. GENERATOR SPECIFICATIONS 60 HZ, 1800 RPM**

Type	C45 N6	C50 N6	C60 N6	C70 N6	C80 N6	C100 N6
Generator	Brushless, 4-pole rotating field, single bearing					
Power (kVA) 1 Phase	45	50	60	70	80	100
Power (kVA) 3 Phase	56.3	62.5	75	87.5	100	125
Rated Voltages (V)	120/240, 1 Ph					
	227/480, 3 Ph					
	347/600, 3 Ph					
	120/240, 3 Ph					
	120/208, 3 Ph					
	127/220, 3 Ph					
	F1PO (Reconnectable, Full Single Phase Output)					

**NOTICE**

**Maximum  $I_2 = 8\%$ . Generator set load unbalance must not exceed 25% between any phases.**

**TABLE 8. GENERATOR SET DERATING GUIDELINES**

Model	Phase	Engine Power Available Up To...		Derate At...	
		Elevation	Ambient Temperature	Elevation	Temperature
C45 N6	Both	2200 ft (675 m)	104 °F (40 °C)	4% per 985 ft (300 m)	2% per 18 °F (10 °C)
C50 N6	Both	490 ft (150 m)	77 °F (25 °C)		
C60 N6	Both	3280 ft (1000 m)	104 °F (40 °C)		
C70 N6	1	8450 ft (2575 m)			
	3	10000 ft (3048 m)			
C80 N6	1	5985 ft (1825 m)			
	3	8200 ft (2500 m)			
C100 N6	1	1560 ft (700 m)	77 °F (25 °C)		
	3	3280 ft (1000 m)	104 °F (40 °C)		

**TABLE 9. CONTROL SPECIFICATIONS (ALL MODELS)**

Control	Purpose
PC 1.1	Generator Set
Enovations I28 EPR	Engine (45, 50, 60 kW Generator Sets)
Enovations 4G LDI	Engine (70, 80, 100 kW Generator Sets)

**TABLE 10. DC SYSTEM SPECIFICATIONS (ALL MODELS)**

Type	Specification
Nominal Battery Voltage	12 VDC
Battery Group	34 Standard, 4D High Capacity (Requires Large Battery Tray)
Battery Type	Maintenance-Free
Minimum Cold Crank Amps	850 Standard, 1080 High Capacity (Requires Large Battery Tray)

**TABLE 11. LUBRICATING OIL SYSTEM SPECIFICATIONS**

Type	Specification
Lubricating Oil Pressure at Idle (Minimum)	15 psi (104 kPa)
Lubricating Oil Pressure at Rated Speed (Minimum)	
Filter Bypass Valve-Opening Pressure	45 psi (311 kPa)
Pressure Regulator Valve-Opening Pressure	65 psi (449 kPa)
Lubricating Oil Capacity (Standard Sump):	
--High	15 qt (14.2 liters)
--Low	13 qt (12.4 liters)
--Total System	16 qt (15.1 liters)

## 2.5 After Sales Services

Cummins Power Generation offers a full range of maintenance and warranty services.

## Maintenance

### WARNING

#### ***Electrical Generating Equipment***

***Incorrect service or parts replacement can result in severe personal injury, death, and/or equipment damage.***

***Make sure service personnel are qualified to perform electrical and mechanical service.***

For expert generator set service at regular intervals, contact your local dealer. Maintenance tasks should only be undertaken by trained and experienced technicians provided by your authorized dealer.

## Warranty

For details of the warranty coverage for your generator set, refer to the *Warranty Statement* listed in the Related Literature section.

Extended warranty coverage is also available. In the event of a breakdown, prompt assistance can normally be given by factory trained service technicians with facilities to undertake all minor and many major repairs to equipment on site.

For further warranty details, contact your authorized dealer.

### NOTICE

**Damage caused by failure to follow the manufacturers recommendations will not be covered by the warranty. Please contact your authorized dealer.**

## Warranty Limitations

For details of the warranty limitations for your generator set, refer to the warranty statement applicable to the generator set.

## How to Obtain Service

For parts, service, and product information (such as the Service Manual), contact the nearest authorized Cummins Power Generation dealer. To easily locate the nearest certified distributor/dealer for Cummins generators in your area, or for more information, contact us at 1-800-344-0039 or visit [power.cummins.com](http://power.cummins.com).

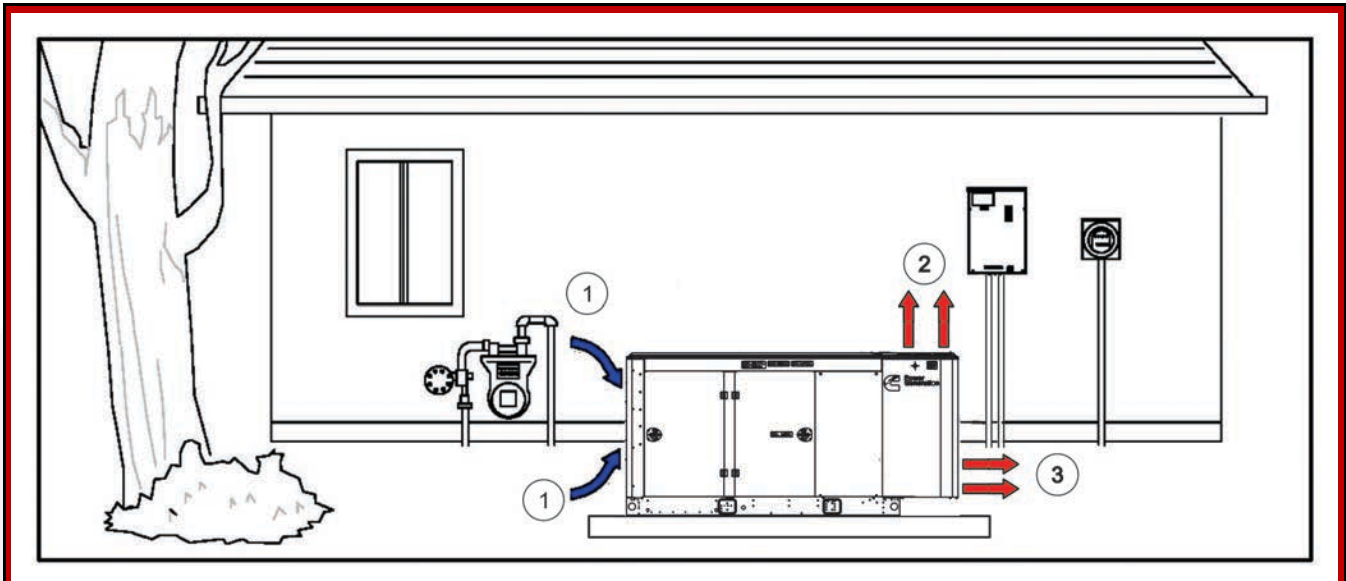
## 2.6 General Operating Conditions

The area surrounding the generator set is critical for safety and its performance. Follow the guidelines below.

- Do not stack anything on top of the generator set.
- Do not store anything inside of the generator set.



- Keep areas clear in front of the cool air in and hot air out (free of obstructions, debris, plants, etc.).



No.	Description	No.	Description
1	Cool Air In	3	Hot Air Out (Weather Enclosure)
2	Hot Air Out (Sound Level Enclosure)		

**FIGURE 1. GENERATOR SET LOCATION**

**NOTICE**

All maintenance procedures must be performed or supervised by authorized and trained service personnel only.

## 2.7 Generator Set Nameplate

**⚠ WARNING**

**Electrical Generating Equipment**  
*Improper service or replacement of parts can lead to severe personal injury or death and to damage to equipment and property.*  
**Make sure service personnel are qualified to perform electrical and mechanical service.**

**NOTICE**

Unauthorized modifications or replacement of fuel, exhaust, air intake or speed control system components that affect engine emissions are prohibited by law in the State of California.

**Model, Spec, and Serial Numbers:** Be ready to provide the model, spec, and serial numbers on the generator set nameplate when contacting Cummins Power Generation for information, parts, and service. The nameplate is located on the inside of the control access door on enclosed products or on the side of the radiator for open products.

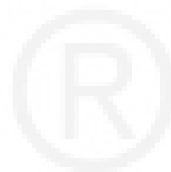
Record these numbers so that they are easy to find when needed. Each character in these numbers is significant for obtaining the right parts listed in the Parts Catalog. Genuine Cummins Power Generation replacement parts are recommended for best results.

My Generator Set Information	
Model	
Spec	
Serial Number	

### 3 Manufacturing Facilities

<b>NORTH AMERICA</b>	<b>EMEA, CIS</b>	<b>ASIA PACIFIC</b>
Cummins Power Generation Limited 1400 73rd Ave. NE Minneapolis, MN 55432 USA	Cummins Power Generation Limited Columbus Avenue Manston Park Manston, Ramsgate Kent CT12 5BF United Kingdom	Cummins Power Generation Limited 10 Toh Guan Road #07-01 TT International TradePark Singapore 608838
Phone +1 763 574 5000 Toll Free +1 800 888 6626 Fax +1 763 574 5298	Phone +44 1843 255000 Fax +44 1843 255902	Phone +65 6417 2388 Fax +65 6417 2399
<b>BRAZIL</b>	<b>CHINA</b>	<b>INDIA</b>
Rua Jati, 310, Cumbica Guarulhos, SP 07180-900 Brazil	Cummins Power Generation 2 Rongchang East Street, Beijing Economic – Technological Development Area Beijing 100176, P.R.China	Cummins India Ltd, Power Generation Business Unit, Plot No B-2, SEZ Industrial Area, Village-Nandal & Surwadi, Taluka- Phaltan Dist- Satara, Maharashtra 415523 India
Phone +55 11 2186 4195 Fax +55 11 2186 4729	Phone +86 10 5902 3000 Fax +86 10 5902 3199	Phone +91 021 66305514
<b>LATIN AMERICA</b>	<b>MEXICO</b>	
3350 Southwest 148th Ave. Suite 205 Miramar, FL 33027 USA	Eje 122 No. 200 Zona Industrial San Luis Potosi, S.L.P. 78395 Mexico	
Phone +1 954 431 551 Fax +1 954 433 5797	Phone +52 444 870 6700 Fax +52 444 824 0082	

This page is intentionally blank.



# 4 Control System

---

## 4.1 Control System Description

The control system is used to start and stop the generator set, and provides full generator set monitoring capability and protection in a stand-alone situation (non-paralleling) from the display screen. It monitors the engine for temperature, as well as oil pressure and speed. It also provides voltage and current metering. In the event of a fault, the unit indicates the fault type and, on critical faults, automatically shuts down the generator set.

All indicators, control buttons, and the display screen are on the face of the operator panel, as illustrated in the figure below.

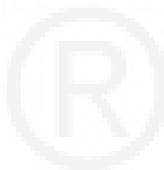
There are three fault level signals generated by the control system:

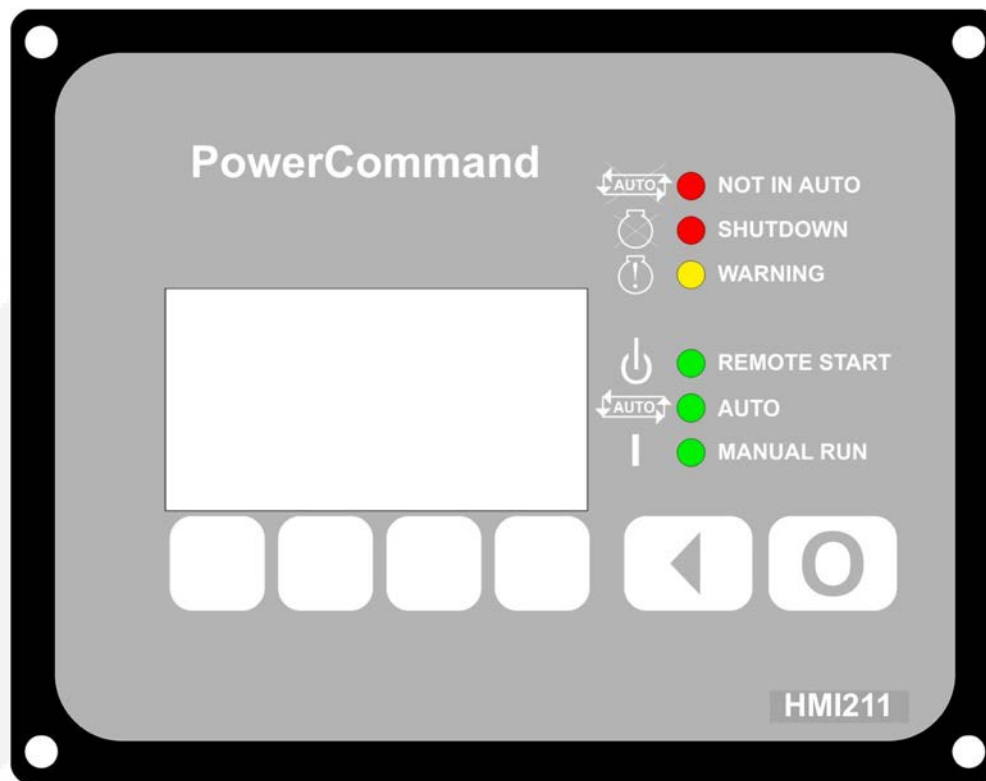
- **Event:** Signals that a temporary condition exists.
- **Warning:** Signals an imminent or non-critical fault for the engine. The control provides an indication only for this condition.
- **Shutdown:** Signals a potentially critical fault for the engine. The control immediately takes the engine off-load and automatically shuts it down.

The standard control system operates on 12 (or 24 VDC if applicable) battery power. History data is stored in non-volatile memory and is not deleted if battery power is lost.

### Standard Operator Panel

The operator panel includes indicator lights (LEDs), display buttons used to navigate through the menus, control mode buttons, and an LCD display. The display enables the operator to check the status, adjust the settings, and start and stop the generator set. The standard operator panel (shown below) is located on every generator set. An optional in-home operator panel accessory is also available for location inside the home.





**FIGURE 2. STANDARD OPERATOR PANEL (HMI211)**

### Standard Key Functions (HMI211)

The user interface includes two fixed action buttons and four soft key buttons. The action of the soft key buttons changes to meet the requirements of each screen.

**TABLE 12. KEY FUNCTIONS**

Key/Symbol	Action
⏻	Switches to Off mode (fixed action button).
↔AUTO↔	Switches to Auto mode.
👉	Switches to Manual Run mode.
◀	Navigates to the previous menu level (fixed action button).
▲	(Up Arrow) Navigates to the previous screen/menu in a list.
▼	(Down Arrow) Navigates to the next screen/menu in a list.
▲and ▼	Hold the up and down arrows simultaneously for two seconds from any Info Menu to navigate to the Menu screen.
Save	Saves changes and navigates to the associated screen.
Adjust	Navigates to the Adjust Menu of a specific menu.
→	(Right Arrow) Advances the highlighted field to the next editable field.

Key/Symbol	Action
-	Decreases value of the highlighted editable field.
+	Increases value of highlighted editable field.

### Standard LED Indicators (HMI211)

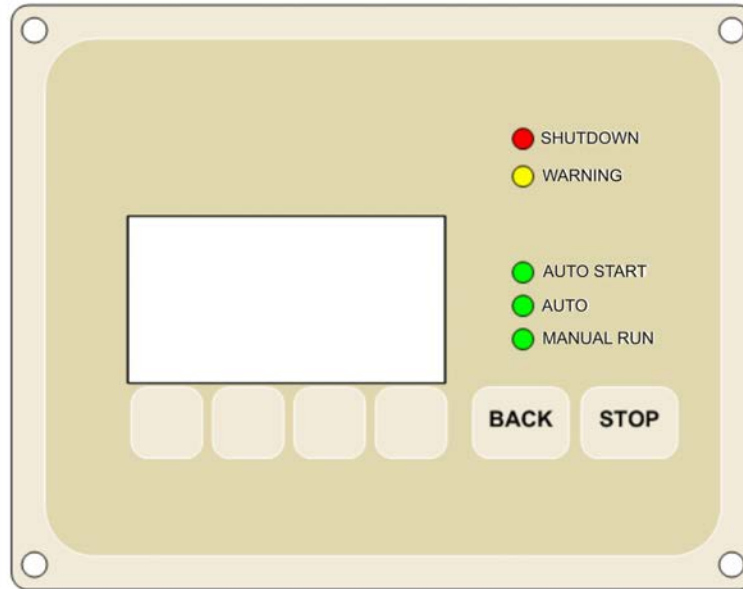
The operator panel has six LED indicators. Colors, flashing frequency, and conditions to turn them on/off/blink are included in the table below.

**TABLE 13. LED INDICATORS**

LED	Color	Action
Not in Auto	Red	Indicates the generator set is in Manual or Off Mode.
Shutdown	Red	Indicates a Shutdown Fault has occurred.
Warning	Yellow	Indicates a Warning Fault has occurred.
Remote Start	Green	Indicates that the generator set has received a Remote Start Command.
Auto	Green	Indicates that the generator set is in Auto Mode. The generator starts when it receives a Remote Start Command.
Manual Run	Green	Indicates that the generator set has received a Manual Run Command.

### In-Home Operator Panel (Accessory)

The in-home operator panel is an optional display that may be purchased. This panel is intended to serve as a convenience option to the standard operator panel mounted on the generator set.



**FIGURE 3. IN-HOME OPERATOR PANEL**

### Key Functions (In-Home Operator Panel)

The user interface includes two fixed action buttons and four soft key buttons. The action of the soft key buttons changes to meet the requirements of each screen.

**TABLE 14. KEY FUNCTIONS**

Key/Symbol	Action
Stop	Switches to Off mode. This key works from any screen (fixed action button).
▲	(Up Arrow) Navigates to the previous screen/menu in a list.
▼	(Down Arrow) Navigates to the next screen/menu in a list.
▲and ▼	Hold the up and down arrows simultaneously for two seconds from any Info Menu to navigate to the Service Menu.
Back	Navigates to the previous screen/menu in a list (fixed action button). In Adjust screens, settings are not saved.
Save	Saves changes and navigates to the associated screen.
Adjust	Navigates to the Adjust Menu of a specific menu.
→	(Right Arrow) Advances the highlighted field to the next editable field.
-	Decreases value of the highlighted editable field.
+	Increases value of highlighted editable field.



## LED Indicators (In-Home Operator Panel)

The operator panel has five LED indicators. Colors, flashing frequency, and conditions to turn them on/off/blink are included in the table below.

**TABLE 15. LED INDICATORS**








LED	Color	Action
Shutdown	Red	Indicates a Shutdown Fault has occurred.
Warning	Yellow	Indicates a Warning Fault has occurred.
Auto Start	Green	Indicates that the generator set has received a Remote Start Command.
Auto	Green	Indicates that the generator set is in Auto Mode. The generator starts when it receives a Remote Start Command.
Manual Run	Green	Indicates that the generator set has received a Manual Run Command.









## 4.2 Display Text or Symbolic Version

The operator panel graphical display can be set to show text (English only) or symbols for fault messages, operator menus, and the Mode Change Menu. Descriptions of commonly used symbols are included in the following table. Combinations of symbols are used to display some fault conditions.

When shipped from the factory, the display is set to display symbols. Qualified service personnel are required to change the default setting.

**TABLE 16. SYMBOLS**

Symbol	Text
	Generator Warning Fault
	Generator Shutdown Fault
	Coolant Temperature
	Oil Pressure
	Voltage Alternating Current (VAC)
	Voltage Direct Current (VDC)
	AC Current
<b>Hz</b>	Frequency

Symbol	Text
	Battery
	Out of Range
	High or Pre-High
	Low or Pre-Low
	Annunciator
	Over Speed
	Crank Fail
	Emergency Stop

### 4.3 Exercise Settings

**NOTICE**

When battery power is lost, these settings must be reset.

**NOTICE**

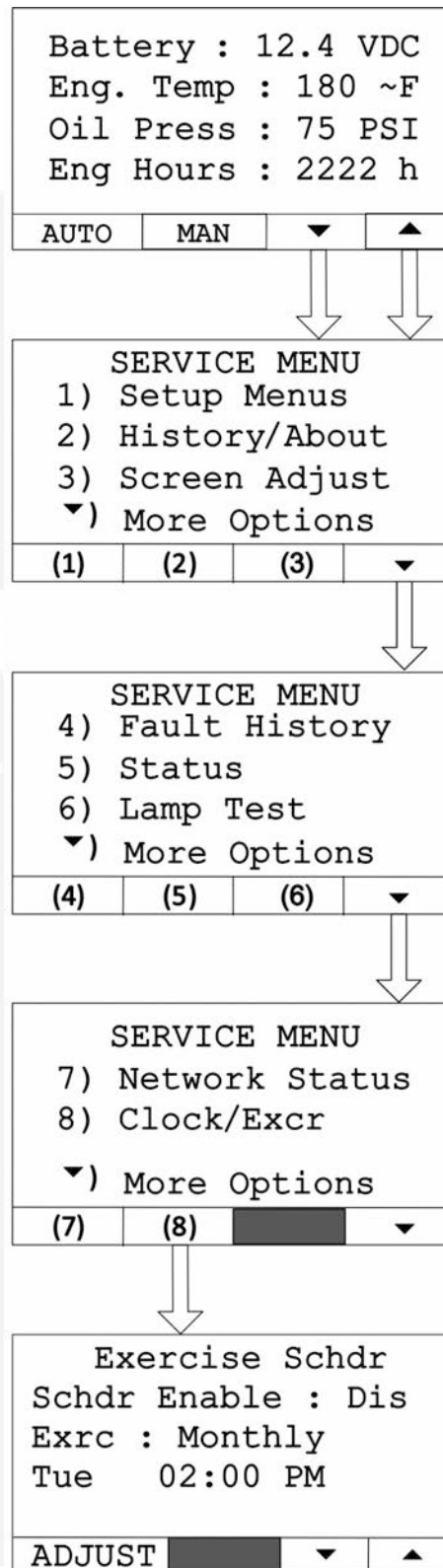
Not applicable without an RA series transfer switch.

To access the Clock/Exerciser Menu:

1. From any Information Menu, hold down the up and down arrows simultaneously for two seconds. The Service Menu appears.
2. Navigate through the screens to find and select **Clock/Excr** in the Service Menu.

**NOTICE**

The following screens represent the standard operator panel (that is, HMI211). If using an in-home operator panel, which may be additionally purchased as an option, the screens may look slightly different. This procedure applies to both operator panels.



**FIGURE 4. CLOCK/EXERCISER MENU NAVIGATION**

## Updating Exercise Frequency

### NOTICE

**Not applicable without an RA series transfer switch.**

To update the exercise frequency and dates on the Clock/Exerciser Menu:

1. From any Information Menu, hold down the up and down arrows simultaneously for two seconds. The Service Menu appears.
2. Access the Time Setup screen by selecting **Clock Exerciser** on the Genset Service Menu.
3. Press the down key on the Time Setup screen to access the Daylight Saving Adjust screen.
4. Select **Adjust**.
5. Press the down key on the Daylight Saving Adjust Start screen.
6. Select **Adjust**.
7. Press **Exercise Schdr** on the Daylight Saving Adjust End screen.
8. Press **Adjust**.

When updating these settings, the functions of the keys are as follows:

- The horizontal right arrow key is used to select successive blocks for editing settings on the screen.
- Use the + or - keys to edit the following settings:
  - Schdr Enable: Enable or Disable
  - Exercise Schedule: Semi-Annual (every six months), Quarterly, Monthly, Bi-Weekly (every two weeks) , or Weekly
  - Exercise Schedule: Day, Hours, Minutes, AM/PM
- Press **Save** to save any changes. After saving, the Save button changes to the Adjust button.

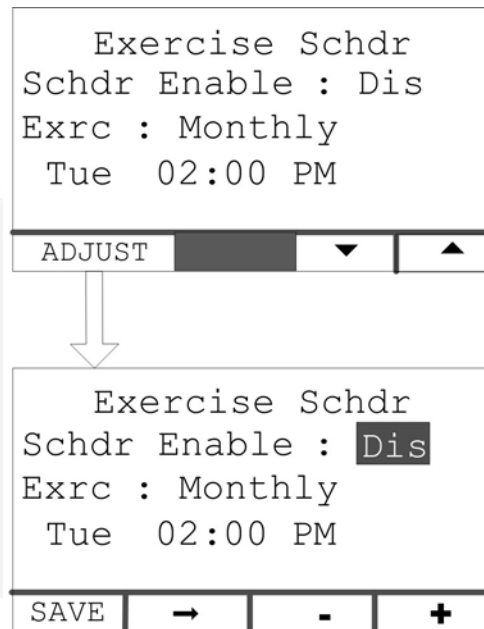


FIGURE 5. EXERCISE FREQUENCY NAVIGATION

## Updating Exercise Duration

### NOTICE

**Not applicable without an RA series transfer switch.**

To update the exercise duration on the Clock/Exerciser Menu:

1. From any Information Menu, hold down the up and down arrows simultaneously for two seconds. The Service Menu appears.
2. Access the Time Setup screen by selecting **Clock Exerciser** on the Genset Service Menu.
3. Press the down key on the Time Setup screen to access the Daylight Saving Adjust screen.
4. Select **Adjust**.
5. Press the down key on the Daylight Saving Adjust Start screen.
6. Select **Adjust**.
7. Press **Exercise Schdr** on the Daylight Saving Adjust End screen.
8. Press the down key on the Exercise Schdr Menu.
9. Press **Adjust**.

When updating these settings, the functions of the keys are as follows:

- The horizontal right arrow key is used to select the duration block for editing exercise duration.
- Use the + or - keys to edit the exercise duration minutes.

- Press **Save** to save any changes. After saving, the Save button changes to the Adjust button.

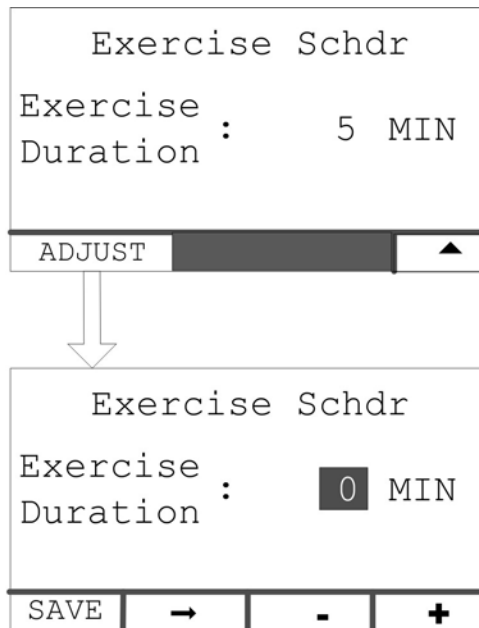


FIGURE 6. EXERCISE DURATION NAVIGATION

## Time Setup

### NOTICE

When battery power is lost, these settings must be reset.

### NOTICE

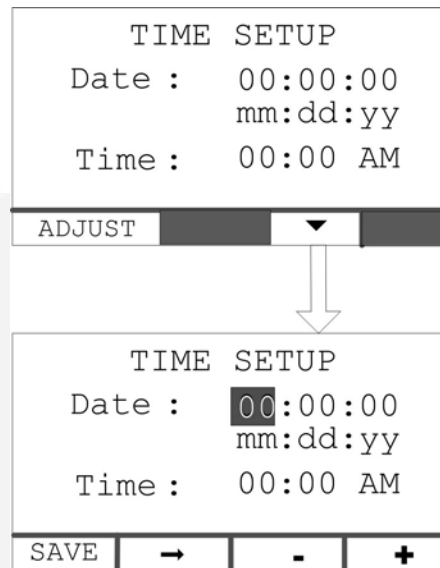
Not applicable without an RA series transfer switch.

To set up the generator set clock for the current date and time:

1. From any Information Menu, hold down the up and down arrows simultaneously for two seconds. The Service Menu appears.
2. Access the Time Setup screen by selecting **Clock Exerciser** on the Genset Service Menu.
3. Select **Adjust**.

When updating these settings, the functions of the keys are as follows:

- The horizontal right arrow key is used to select successive blocks for editing settings on the screen.
- Select the left arrow to return to the previous screen.
- Adjust values by using the + or - keys on the Adjust Menu of the Time Setup screen.
- Press **Save** to save any changes. After saving, the Save button changes to the Adjust button.



**FIGURE 7. TIME SETUP SCREEN**

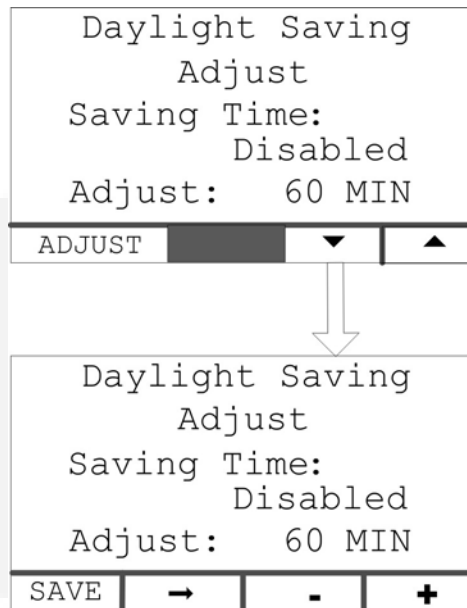
### Updating Daylight Saving Adjust Screen

To update the Time and Adjustment on the Daylight Saving Adjust screen:

1. From any Information Menu, hold down the up and down arrows simultaneously for two seconds. The Service Menu appears.
2. Access the Time Setup screen by selecting **Clock Exerciser** on the Genset Service Menu.
3. Press the down key on the Time Setup screen to access the Daylight Saving Adjust screen.
4. Select **Adjust**.

When updating these settings, the functions of the keys are as follows:

- The horizontal right arrow key is used to select successive blocks for editing settings on the screen.
- Select the left arrow to return to the previous screen.
- Adjust values by using the + or - keys on the Adjust screen of the Daylight Saving Adjust screen.
- Press **Save** to save any changes. After saving, the Save button changes to the Adjust button.



**FIGURE 8. DAYLIGHT SAVING ADJUST SCREEN NAVIGATION**

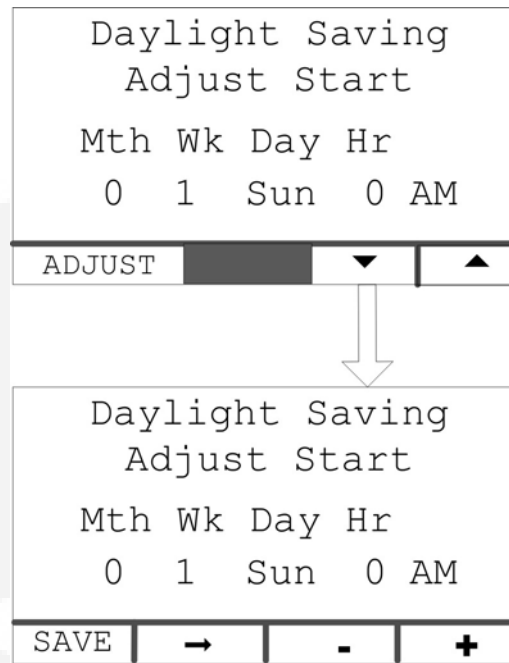
To access and update the Daylight Saving Adjust Start screen:

1. Press the down key on the Daylight Saving Adjust screen.
2. Press **Adjust**.

When updating these settings, the functions of the keys are as follows:

- The horizontal right arrow key is used to select successive blocks for editing settings on the screen.
- Use the + or - keys to edit the following settings:
  - Month
  - Week
  - Day
  - Hour
- Press **Save** to save any changes. After saving, the Save button changes to the Adjust button.





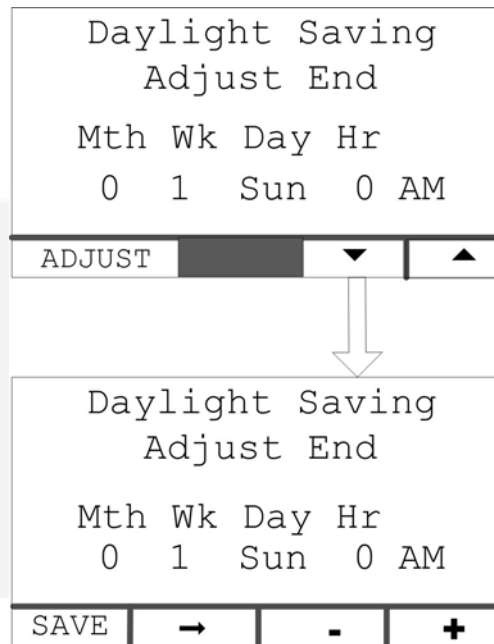
**FIGURE 9. DAYLIGHT SAVING ADJUST START SCREEN**

To access and update the Daylight Saving Adjust End screen:

1. Press the down key on the Daylight Saving Adjust Start screen.
2. Press **Adjust**.

When updating these settings, the functions of the keys are as follows:

- The horizontal right arrow key is used to select successive blocks for editing settings on the screen.
- Use the + or - keys to edit the following settings:
  - Month
  - Week
  - Day
  - Hour
- Press **Save** to save any changes. After saving, the Save button changes to the Adjust button.



**FIGURE 10. DAYLIGHT SAVING ADJUST END SCREEN**

## 4.4 Brightness and Contrast

The Screen Adjust screen allows the contrast, brightness, and units to be set. To access the Screen Adjust screen:

1. From any Information screen, hold down the up and down arrows simultaneously for two seconds to gain access to the Service Menu screen.
2. Select **Screen Adjust**.

To adjust the contrast, brightness, or units from the Screen Adjust screen:

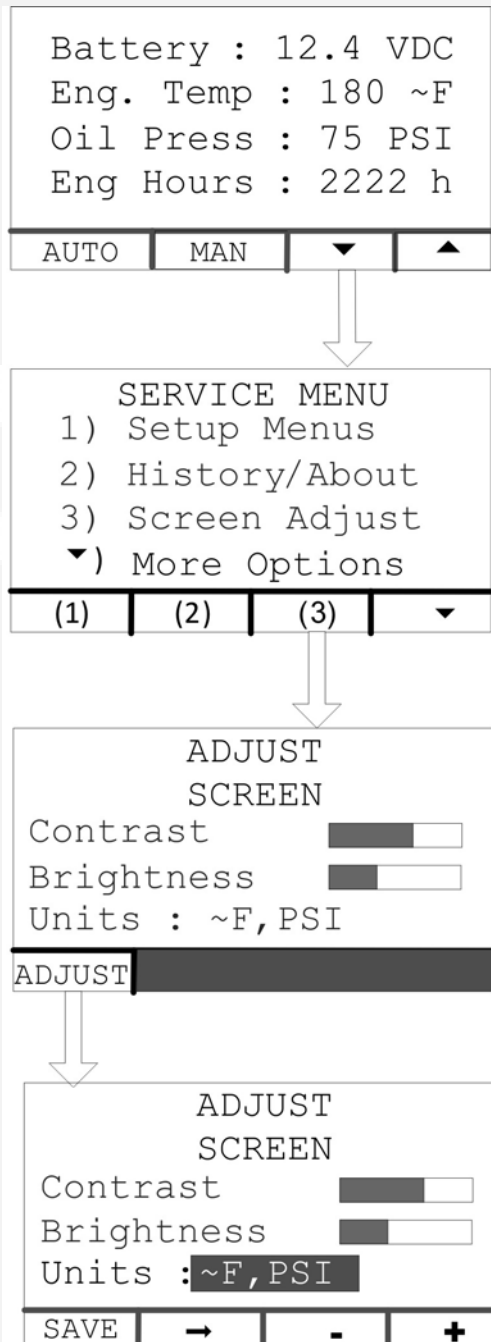
1. From the Screen Adjust screen, select **Adjust** to access the screen variables.
2. Press the right arrow to move between the variables.
3. Adjust settings, and press **Save** to save any changes.

When updating these settings, the functions of the keys are as follows:

- The horizontal right arrow key is used to select successive blocks for editing settings on the screen.
- Select the left arrow to return to the previous screen.
- Adjust values by using the + or - keys on the Adjust screen of the Display Setup screen.
- Press **Save** to save any changes. After saving, the Save button changes to the Adjust button.

**NOTICE**

The following screens represent the standard operator panel (HMI211). If using an in-home operator panel, which may be additionally purchased as an option, the screens may look slightly different. This procedure applies to both operator panels.



**FIGURE 11. BRIGHTNESS AND CONTRAST SCREEN NAVIGATION**

**NOTICE**

Adjusting the brightness on the operator panel adjusts the brightness of both the LCD backlight and the LEDs on the display. The contrast should never be 0 or 100% on any of the screens. The default value for Brightness is 50%.

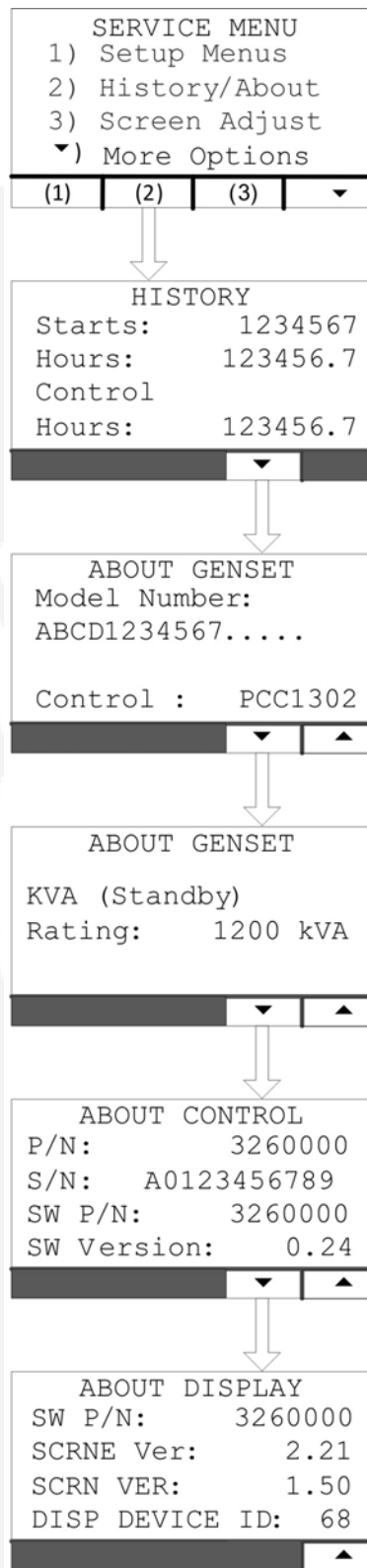
## 4.5 History and About Menu

To access the History/About screen:

1. From any Information Menu, hold down the up and down arrows simultaneously for two seconds. The Service Menu appears.
2. Select **History/About**.
3. Advance through the screens to view information about the generator set, control, and display.

**NOTICE**

The following screens represent the standard operator panel (HMI211). If using an in-home operator panel, which may be additionally purchased as an option, the screens may look slightly different. This procedure applies to both operator panels.



**FIGURE 12. HISTORY/ABOUT MENU**

## 4.6 Fault Log

To check the fault log:

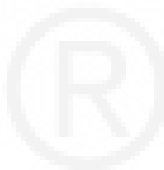
1. From any Information Menu, hold down the up and down arrows simultaneously for two seconds. The Service Menu appears.
2. Select **Fault History**.

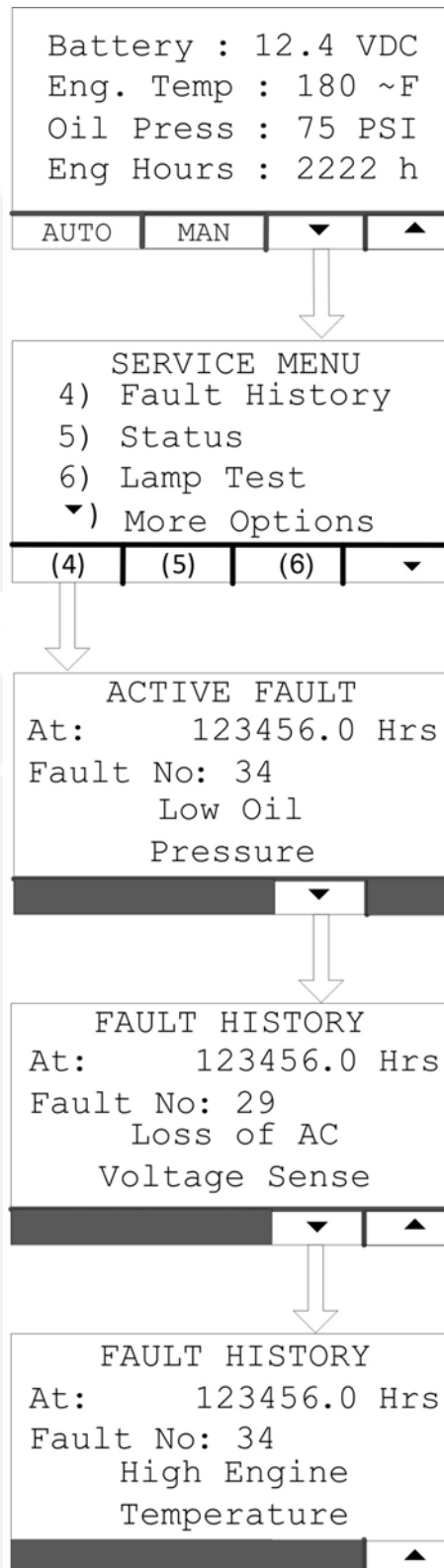
### *NOTICE*

The active faults are displayed first. If there are no active faults, this screen is skipped. Following the Active Faults screen are the Fault History screens. These screens display the faults in chronological order from newest to oldest.

### *NOTICE*

The following screens represent the standard operator panel (HMI211). If using an in-home operator panel, which may be additionally purchased as an option, the screens may look slightly different. This procedure applies to both operator panels.





**FIGURE 13. FAULT LOG SCREEN**

## 4.7 Selecting Operating Modes





### Selecting Manual Run Mode

#### WARNING

##### ***Electrical Generating Equipment***

***When changing modes, the generator set can start or stop without warning (for example, Auto Mode may have been selected with no mains (utility) power available).***

***Make sure there is no danger to personnel or equipment, if the generator set starts or stops when changing modes.***

1. Before proceeding to change the mode, make sure that it is safe to do so.
2. Press the  Manual Run button on any of the Operator menus or the "Establishing/Re-establishing communication with control" menus.
3. If the Mode Change Access Code menu is enabled, the Mode Change Access Code is displayed. Enter the Mode Change Access Code.
4. A menu with alternating arrows is displayed above a second  symbol.
5. Press the second  Manual Run button, and the generator set will now begin the Manual start sequence. The Operator menu that was displayed before Manual Run mode was selected is re-displayed, but with the  symbol blacked out.

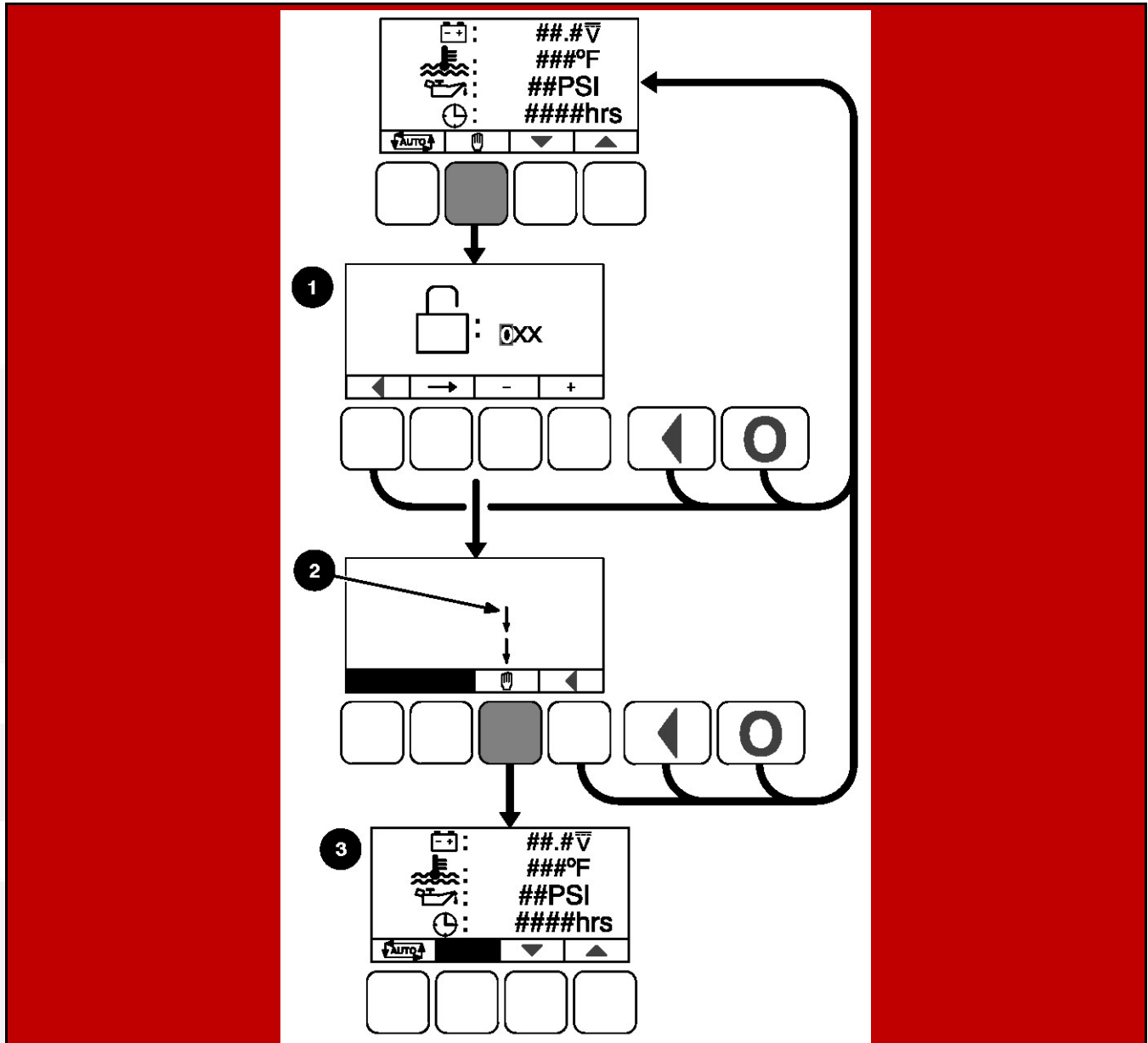
#### NOTICE

**To disable Manual Run mode, press the Off button.**

#### NOTICE

**Auto mode can also be selected while in Manual Run mode. Switching to Auto mode may result in the generator set shutting down.**





No.	Description	No.	Description
1	Menu Displayed Only When the Mode Change Access Code Feature Is Enabled	3	Manual Run Mode Selected
2	Alternating Arrows Displayed		

FIGURE 14. SELECTING MANUAL RUN MODE

## Selecting Auto Mode






### WARNING

#### ***Electrical Generating Equipment***

***When changing modes, the generator set can start or stop without warning (for example, Auto Mode may have been selected with no mains (utility) power available).***

***Make sure there is no danger to personnel or equipment, if the generator set starts or stops when changing modes.***

To switch to Auto mode (see [Figure 15 on page 47](#)),

1. Ensure that it is safe to do so before proceeding to change the mode.
2. Press the  Auto button on any of the Operator menus, or the 'Establishing/Re-establishing communication with control' menus.
3. If the mode change access code feature is enabled, the Mode Change Access Code menu is displayed. Enter the Mode Change Access Code.
4. A menu with alternating arrows will then be displayed above a second  Auto symbol.
5. Press this second  Auto button. The Operator menu that was displayed before Auto mode was selected is re-displayed, but with the  Auto symbols blacked out and  Manual Run symbols visible.

To disable Auto mode, press the Off button.

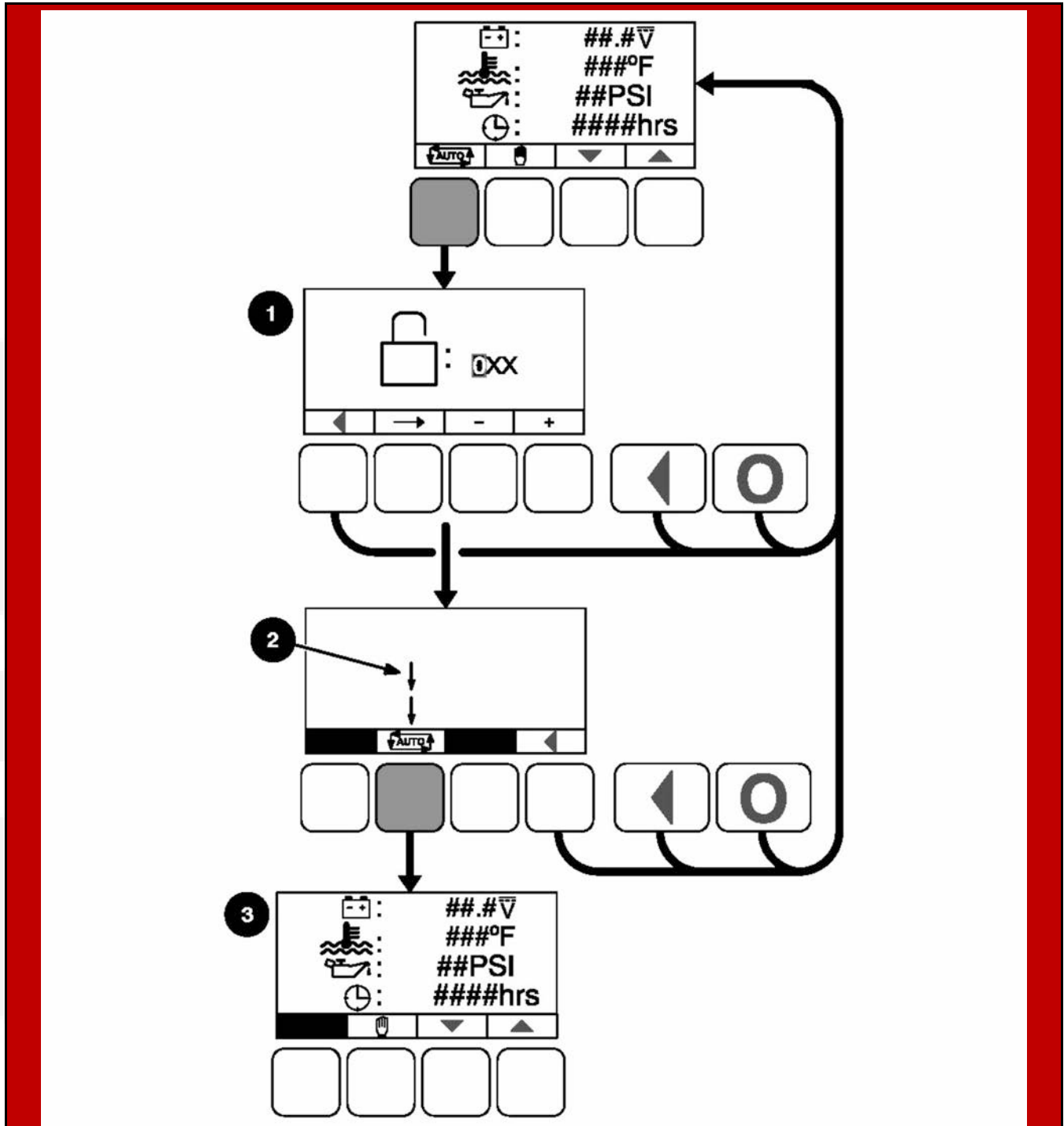
The generator set is now ready to receive a remote start signal that will initiate the Auto run mode.

### WARNING

***Should a remote start signal be received, the generator set starts automatically. Make sure there is no danger to personnel or equipment should the generator set start without warning.***

### NOTICE

**Manual Run mode can also be selected FROM Auto mode. Switching to Manual Run mode results in the generator set starting up.**



No.	Description	No.	Description
1	This Menu Is Displayed Only if the Mode Change Access Code Feature Is Enabled	3	Auto Mode Selected
2	Alternating Arrows Are Displayed		

**FIGURE 15. SELECTING AUTO MODE**

## Selecting Off Mode

### WARNING

#### ***Electrical Generating Equipment***

***When changing modes, the generator set can start or stop without warning (for example, Auto Mode may have been selected with no mains (utility) power available).***

***Make sure there is no danger to personnel or equipment, if the generator set starts or stops when changing modes.***

To switch to Off mode (see the figure below),

1. Make sure that it is safe to do so before proceeding to stop the set.
2. Press the Off button on any of the Operator menu or the "Establishing/Re-establishing communication with control" menus.
3. If the Mode Change Access Code is enabled, the Mode Change Access Code will be displayed. Enter the Mode Change Access Code.
4. On entering the last correct digit, the basic screen will re-appear, and the set will stop without a Time Delay to Stop.

### NOTICE

**Make sure that there is no danger to personnel or equipment if the generator set is stopped.**

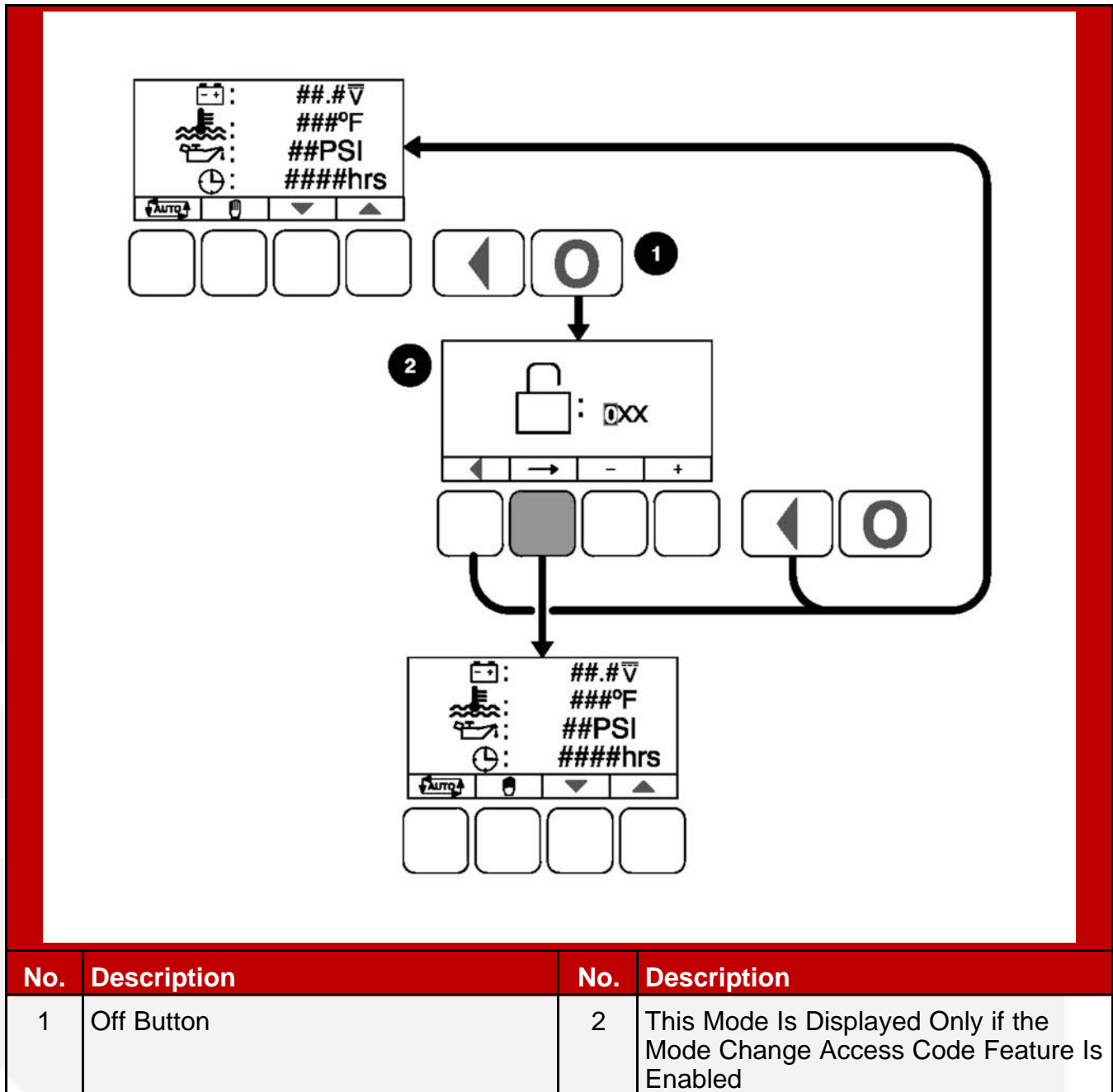


FIGURE 16. SELECTING OFF MODE

## 4.8 Operating Modes

The generator set control works with a Manual Run/Off/Auto switch, used to control generator set operating modes.

## Off Mode

When in Off mode, the control does not allow the generator set to start. If the generator set is already running and the control is set to Off, it initiates a normal shutdown sequence.

## Manual Run Mode

When in Manual Run mode, the generator set starts and continues to run until the control is put into the Off mode. While in Manual Run mode, the remote start signal is ignored.

## Auto Mode

When in Auto mode, the control allows the generator set to be started with a remote start signal only.

When in Auto mode, the generator set can start at any time. When a remote start signal is received, the genset starts after a time delay preheat (if programmed) and time delay start (if programmed) is completed.

If the generator set is running in Auto mode and the Off button is pressed, the control immediately stops the genset and the control transitions to the Off mode.

When all remote start signals are removed, the control performs a normal shutdown sequence which may include a time delay stop.



# 5 Operation - PowerCommand 1.1

---

## 5.1 Introduction

This section describes the operation of the generator set. The text should be read in conjunction with the Control System section of this manual.

All indicators, control switches/buttons, and graphical display are located on the face of the Operator Panel.

## 5.2 General Operating Conditions

The area surrounding the generator set is critical for safety and its performance. Follow the guidelines below.

- Do not stack anything on top of the generator set.
- Do not store anything inside of the generator set.
- Keep areas clear in front of the cool air in and hot air out (free of obstructions, debris, plants, etc.).

### NOTICE

**All maintenance procedures must be performed or supervised by authorized and trained service personnel only.**

## 5.3 Generator Set Operation

### ⚠ WARNING

#### ***Combustible Vapors***

***Do not operate an engine where there are or can be combustible vapors.***

***These vapors can be sucked through the air intake system and cause engine acceleration and overspeeding, which can result in a fire, an explosion, personal injury and extensive property damage.***

Correct care of your engine will result in longer life, better performance, and more economical operation.

Cummins Power Generation does not know how you will use your generator set. The equipment owner and operator, therefore, is responsible for safe operation in the installation site environment. Consult your authorized dealer for further information.

**NOTICE**

Cummins Power Generation recommends the installation of an air intake shutoff device or a similar safety device to minimize the risk of overspeeding where an engine will be operated in a combustible environment.

**NOTICE**

Long periods of idling (more than ten minutes) can damage an engine. Do not idle the engine for excessively long periods.

## Sequence of Operation

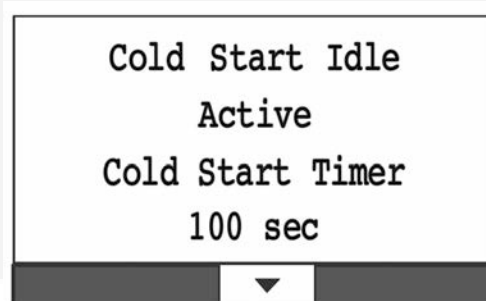
**NOTICE**

The following sequences are based on an approximate time duration. Your generator set may vary slightly from the timing diagrams in this manual. All referenced times are based on default control settings. The following sequences are applicable to generator sets connected to an RA series transfer switch.

### Power Outage Sequence

The sequence of operation after a power outage (when the generator set is in Auto Mode) is as follows:

1. In normal operation, the utility power is running to the transfer switch and then to the building load, and the generator set is off.
2. The utility power turns off (power outage).
3. One second after the power outage, the transfer switch sends the command to the generator set to start.
4. If the ambient temperature is below 20 °F (6.7 °C), the generator set will idle at 800 rpm for up to 2 minutes to allow sufficient turbo lubrication.
  - Idle time is linear from 2 minutes at -40 F (4 °C), or below to off at 20 °F (6.7 °C) or above.



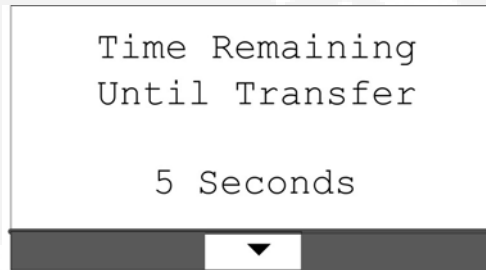
**FIGURE 17. COLD START IDLE ACTIVE**



**NOTICE**

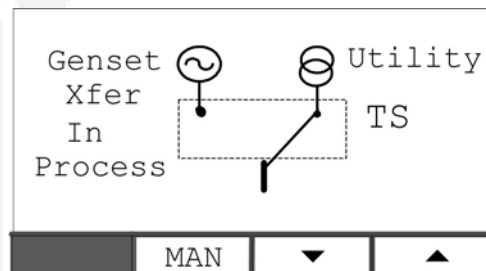
**The control box area is equipped with an ambient temperature sensor for controlling the idle feature. Do not install any heaters in the control box area as this can influence the sensor and lead to engine damage.**

- After the generator set ramps up to rated speed, the generator set provides voltage to the transfer switch, but the transfer switch does not switch (allowing the voltage to go to the building) until after a delay.



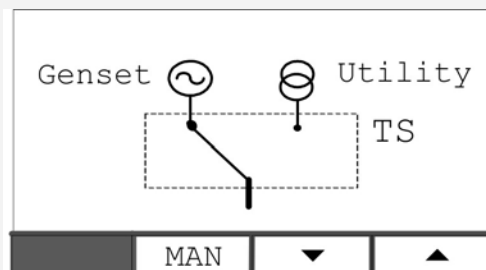
**FIGURE 18. TIME REMAINING UNTIL TRANSFER SCREEN**

- Five seconds after starting, the generator set provides a signal to the transfer switch to transfer the building load to the generator set.



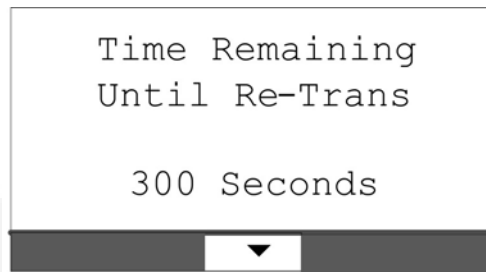
**FIGURE 19. BUILDING LOAD TRANSFER IN PROCESS**

- The transfer switch switches the generator set power to the building load. The building is now running on generator power.



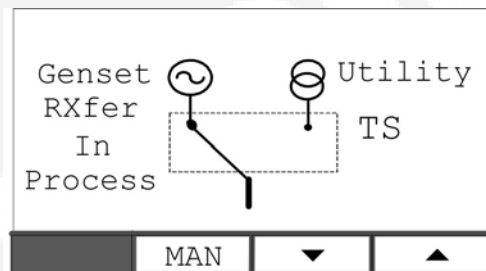
**FIGURE 20. GENERATOR SET POWERING BUILDING LOAD**

- When the utility power is back and providing voltage to the transfer switch, the transfer switch waits for utility power stability.

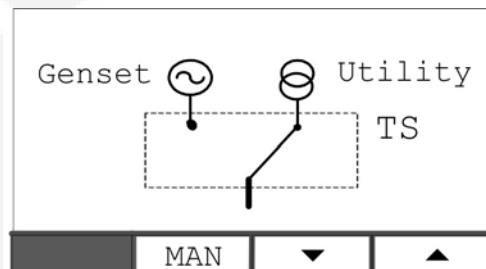


**FIGURE 21. TIME REMAINING UNTIL RE-TRANSFER**

9. When the utility power is stable for 5 minutes, the transfer switch switches back to utility power.

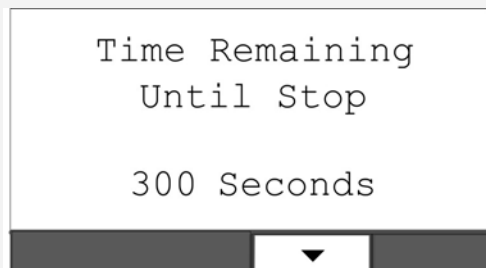


**FIGURE 22. BUILDING LOAD TRANSFER IN PROCESS**



**FIGURE 23. UTILITY POWERING BUILDING LOAD**

10. The generator set runs for a 5-minute cooldown and shuts off.



**FIGURE 24. TIME REMAINING UNTIL STOP**

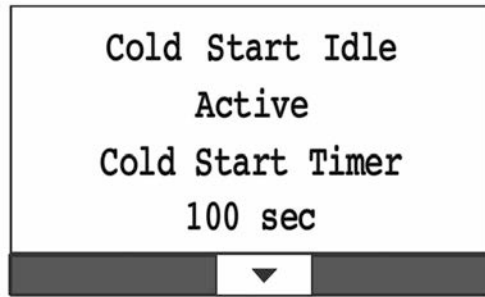
11. Normal operation resumes.

**Exercise Sequence**

The exercise sequence when the programmed exercise time is realized (the generator set is in Auto Mode) is as follows:

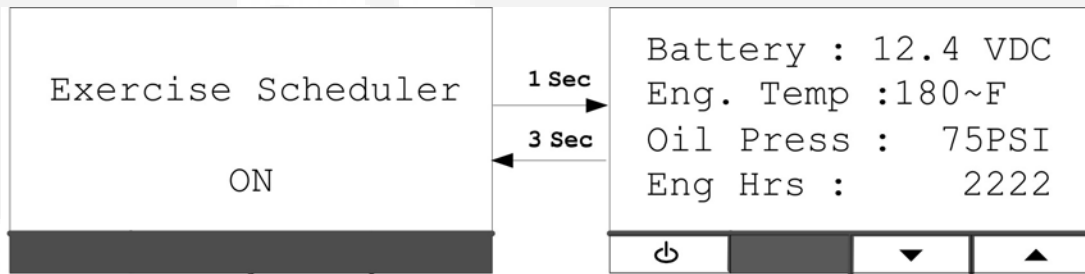
1. The generator set starts and runs.

2. If the ambient temperature is below 20 °F (6.7 °C), the generator set will idle at 800 rpm for up to 2 minutes to allow sufficient turbo lubrication.
  - Idle time is linear from 2 minutes at -40 F (4 °C), or below to off at 20 °F (6.7 °C) or above.



**FIGURE 25. COLD START IDLE ACTIVE**

3. The Exerciser Scheduler On screen displays every 3 seconds and toggles between the existing Information screen that is displayed for 1 second.



**FIGURE 26. EXERCISER SCHEDULER SCREEN AND INFORMATION SCREEN TOGGLE - EXAMPLE**

4. The transfer switch is not commanded to switch the building load to the generator set.

**NOTICE**

The user may navigate to other screens from the Information screens during this duration. No functional keys are active on the Exerciser Scheduler On screen.

5. The generator set stops after programmed exercise run time.

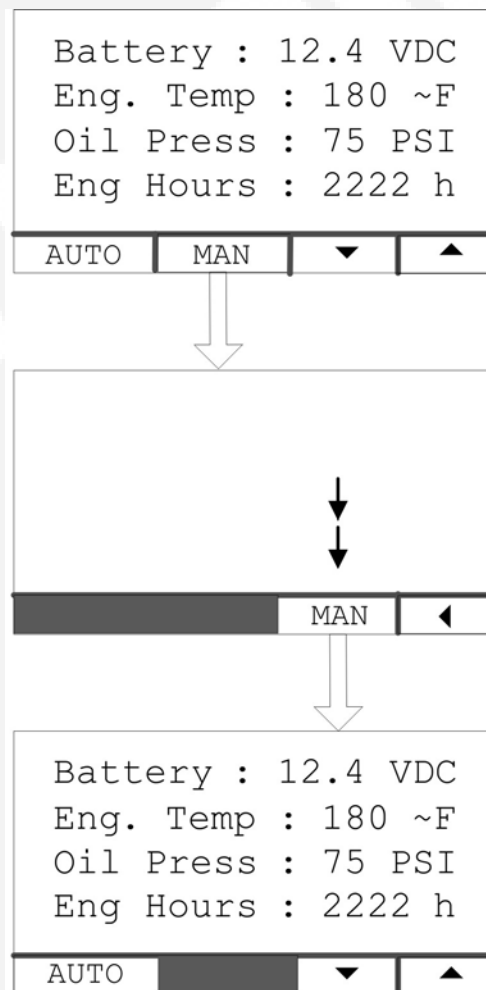
### Manually Starting the Generator Set Sequence

If the generator set is manually started with the standard operator panel, HMI211 (the generator set is in Man Mode), the sequence is as follows:

**NOTICE**

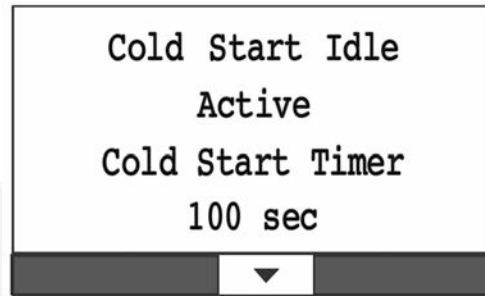
Open the generator set main line circuit breaker to prevent the transfer switch from transferring building load to the generator set. The generator set display will still show the RA series ATS transfer; however, the switch will not transfer if the generator set breaker is open.

1. In normal operation, the utility power is running to the transfer switch and then to the building load, and the generator set is off.
2. Manually start the generator set via the standard control (HMI211) mounted on the generator set.



**FIGURE 27. MANUAL START SCREEN, STANDARD OPERATOR PANEL**

3. The generator set starts.
4. If the ambient temperature is below 20 °F (6.7 °C), the generator set will idle at 800 rpm for up to 2 minutes to allow sufficient turbo lubrication after which the generator will ramp up to rated speed.
  - Idle time is linear from 2 minutes at -40 F (4 °C), or below to off at 20 °F (6.7 °C) or above.



**FIGURE 28. COLD START IDLE ACTIVE**

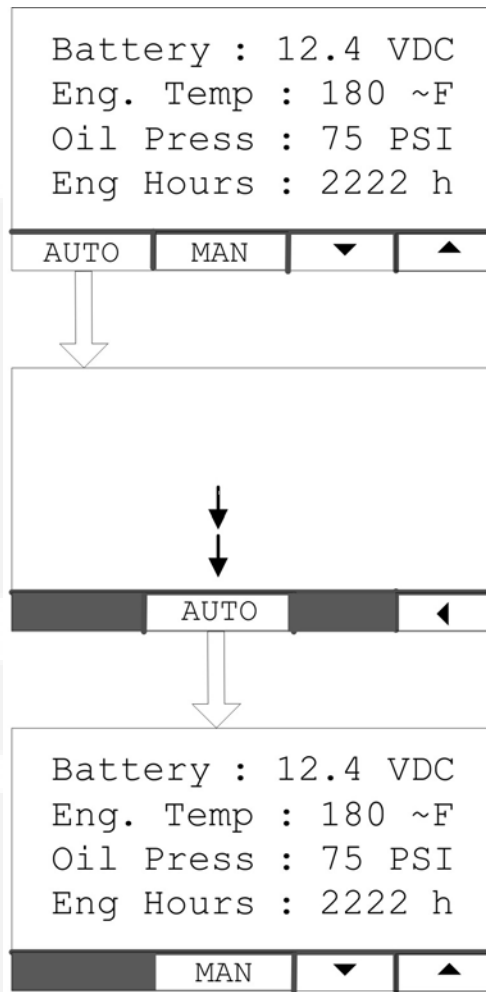
5. The generator set provides voltage to the transfer switch. (However, the transfer switch does not transfer in manual mode.)

### **Remote Starting the Generator Set Sequence**

If the generator set is remote started with the in-home operator panel accessory, if equipped (the generator set is in Auto Mode), the sequence is as follows:

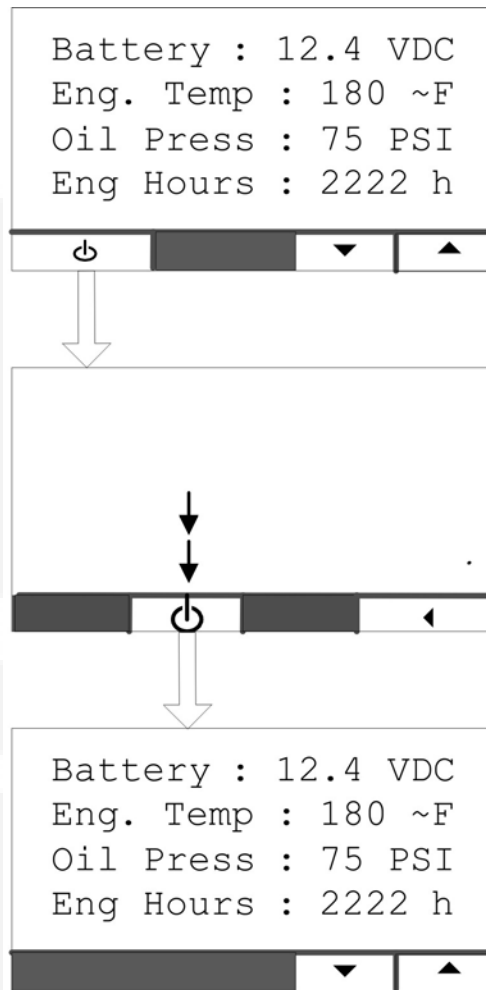
1. In a normal operation, the utility power is running to the transfer switch and then to the building load, and the generator set is off.
2. The generator set-mounted control (HMI211) is set in Auto Mode.





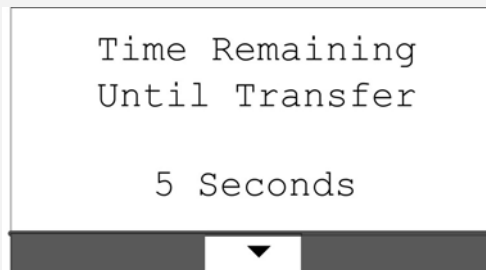
**FIGURE 29. HMI211 SET IN AUTO MODE**

3. Manually start the generator set via the in-home operator panel.



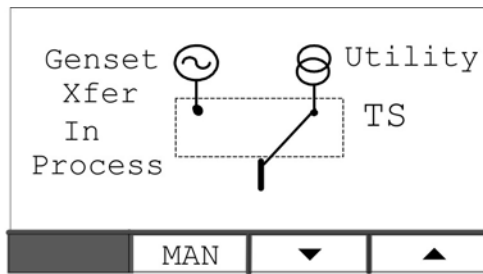
**FIGURE 30. MANUAL START SCREEN, IN-HOME OPERATOR PANEL**

- 4. The generator set starts and provides voltage to the transfer switch, but the transfer switch does not switch (allowing the voltage to go to the building) until after a delay.



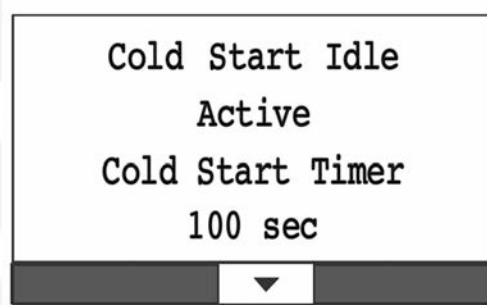
**FIGURE 31. TIME REMAINING UNTIL TRANSFER SCREEN**

- 5. Five seconds after starting, the generator set provides a signal to the transfer switch to transfer the building load to the generator set.



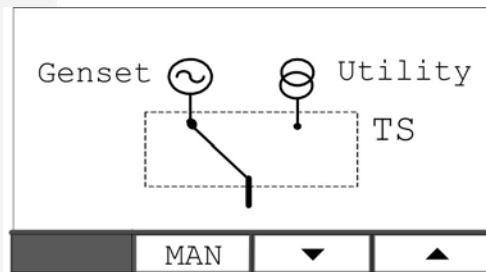
**FIGURE 32. BUILDING LOAD TRANSFER IN PROCESS**

6. If the ambient temperature is below 20 °F (6.7 °C) , the generator set will idle at 800 rpm for up to 2 minutes to allow sufficient turbo lubrication.
  - Idle time is linear from 2 minutes at -40 F (4 °C), or below to off at 20 °F (6.7 °C) or above.



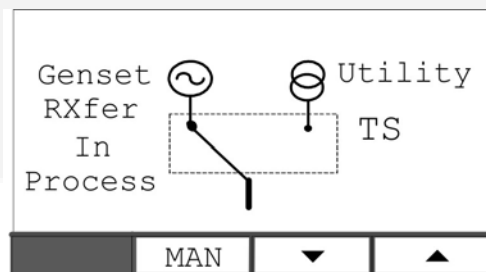
**FIGURE 33. COLD START IDLE ACTIVE**

7. The transfer switch switches the generator set power to the building load. The building is now running on generator power.



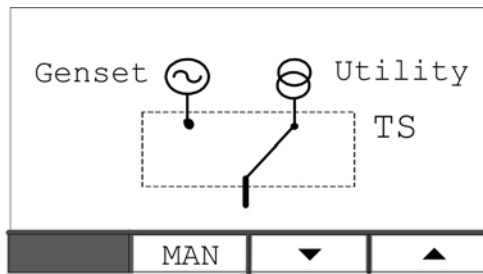
**FIGURE 34. GENERATOR SET POWERING BUILDING LOAD**

8. When the remote display Stop button is pressed, the transfer switch switches back to utility power after a 5 minute retransfer delay.



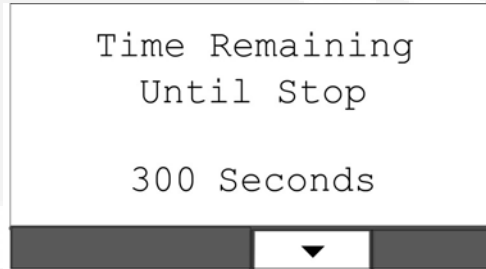
**FIGURE 35. BUILDING LOAD TRANSFER IN PROCESS**





**FIGURE 36. UTILITY POWERING BUILDING LOAD**

9. The generator set runs for a 5-minute cooldown and shuts off.



**FIGURE 37. TIME REMAINING UNTIL STOP**

10. Normal operation resumes.

This page is intentionally blank.



# 6 Maintenance

---

## 6.1 Maintenance Safety

**⚠ WARNING**

***Automated Machinery***

***Accidental or remote starting of the generator set can cause severe personal injury or death.***

***Isolate all auxiliary supplies and use an insulated wrench to disconnect the starting battery cables (negative [-] first).***

**⚠ WARNING**

***Hydrogen Gas***

***Arcing can ignite explosive hydrogen gas given off by batteries, causing severe personal injury or death. Arcing can occur when cables are removed or replaced, or when the negative (-) battery cable is connected and a tool used to connect or disconnect the positive (+) battery cable touches the frame or other grounded metal part of the generator set.***

***Insulated tools must be used when working in the vicinity of the batteries. Always remove the negative (-) cable first and reconnect last.***

**⚠ WARNING**

***Explosive Fumes***

***Arcing can ignite explosive fumes causing severe personal injury or death.***

***Make sure hydrogen from the battery, engine fuel and other explosive fumes are fully dissipated before working on the generator set.***

**⚠ WARNING**

***Working at Heights***

***Using the incorrect equipment when working at heights can result in severe personal injury or death.***

***Suitable equipment for performing these tasks must be used in accordance with the local guidelines and legislation. Failure to follow these instructions can result in severe personal injury or death.***

**⚠ WARNING****Access**

*Using the generator set or part of as a means of access when attaching lifting shackles, chains, or other lifting aids, may damage the generator set, causing severe personal injury or death.*

*Do not use the generator set as a means of access. Failure to follow these instructions can result in severe personal injury or death.*

**⚠ WARNING****Exposed Terminations**

*Some panel internal components may have live exposed terminations even if the generator set is not running. Voltages are present which can cause electrical shock, resulting in personal injury or damage to equipment.*

*Isolate all external electrical supplies prior to access of the control panel*

**NOTICE**

**Only authorized and qualified maintenance technicians who are familiar with the equipment and its operation should carry out maintenance.**

**NOTICE**

**Dependent upon the control system fitted, this unit may operate automatically and could start without warning.**

**NOTICE**

**Always disconnect a battery charger from its AC source before disconnecting the battery cables. Failure to do so can result in voltage spikes high enough to damage the DC control circuits of the generator set.**

All maintenance tasks must be performed, but be sure to assess them for health and safety risks before starting. For example, perform a task with someone present if doing so will add significantly to the safety of the task.

Read, understand, and comply with all Caution, Warning, and Danger notes in this section, the Important Safety Instructions section, and the documentation supplied with the generator set.

Make sure that adequate lighting is available.

## Locking the Generator Set Out of Service

Before any work is carried out for maintenance, etc., the generator set must be immobilized. Even if the generator set is put out of service by pressing the Off switch on the Operator Panel, the generator set cannot be considered safe to work on until the engine is properly immobilized, as detailed in the following procedure.


**NOTICE**

**Refer also to the engine-specific Operator Manual, if applicable. This manual contains specific equipment instructions that may differ from the standard generator set.**

To immobilize the generator set:

1. Press the Off mode switch on the Operator Panel to shut down the engine.
2. Press the Emergency Stop button (if applicable). This will prevent the starting of the generator set regardless of the Start signal source and will therefore provide an additional safety step for immobilizing the generator set. Alternatively, make sure the generator set is in manual mode (which allows it to be started by manually pushing the buttons).

**NOTICE**

**When the Emergency Stop button is pressed, the Operator Panel indicates the Shutdown condition by illuminating the red Shutdown status LED  and displaying a message on the graphical LCD display.**

3. As an additional precaution, thoroughly ventilate the generator set before disconnecting any leads.
4. De-energize and lock off the electrical power source to the heater, where fitted.
5. De-energize and lock off the electrical power source to the battery charger, where fitted.
6. Turn off the fuel supply to the engine.
7. Disconnect the battery. Disconnect the negative (–) cable first, using an insulated wrench.
8. Place warning notices at each of the above locations that state, "Maintenance in Progress – Immobilized for Safe Working."

## 6.2 Periodic Maintenance

** WARNING*****Electrical Generating Equipment***

***Accidental or remote starting of the generator set can cause severe personal injury or death.***

***Before working on the generator set, make sure that the generator set is in Off mode, disable the battery charger, and remove the negative (–) battery cable from the battery to prevent starting.***

The table(s) that follow show the recommended service intervals for a generator set on Standby service. If the generator set will be subjected to extreme operating conditions, the service intervals should be reduced accordingly.

The periodic maintenance procedures should be performed at whichever interval occurs first (calendar time or hours of operation). At each scheduled maintenance interval, perform all previous maintenance checks that are due for scheduled maintenance.

Some of the factors that can affect the maintenance schedule are:

- Extremes in ambient temperature
- Exposure to elements
- Exposure to salt water
- Exposure to windblown dust or sand

Consult with an authorized dealer if the generator set will be subjected to any extreme operating conditions and determine if extra protection or a reduction in service intervals is needed. Use the running time meter to keep an accurate log of all service performed for warranty support. Perform all service at the time period indicated, or after the number of operating hours indicated, whichever comes first.

Repair or replace worn, damaged, or improperly functioning components identified during periodic maintenance procedures.

## Periodic Maintenance Guidelines

Regularly performing the following periodic maintenance tasks greatly reduces the chances of a generator set shutdown:

- Maintain an appropriate oil level.
- Keep battery connections clean and tight.
- Do not overload the generator set.
- Keep the air inlet and outlet openings clear.

## Periodic Maintenance Schedule

### **NOTICE**

**Perform maintenance tasks as specified using daily or hourly periods, whichever is sooner.**

**TABLE 17. PERIODIC MAINTENANCE SCHEDULE**

<b>Maintenance Items</b>	<b>After Every 24 Hours of Run Time<sup>1</sup></b>	<b>After Every 50 Hours of Run Time</b>	<b>12 Months or After 250 Hours<sup>2</sup></b>	<b>2 Years or After 500 Hours<sup>2</sup></b>
Check air cleaner restriction indicator (where fitted): If the indicator shows red, replace air cleaner element and reset the indicator.	■			
Check air intake system for leaks: Visually inspect for signs of wear or damage. Check audibly when the generator set is running. Replace worn or damaged components.	■			
Check coolant level of radiator: If low, top up to coolant system specifications level, with Cummins recommended coolant mix.	■			
Check cooling fan blades: Visually inspect the blades through the guarding for signs of wear or damage. To replace, contact your authorized distributor.	■			
Checking drive belt condition and tension: Visually check belt for evidence of wear or slippage. To replace, contact your authorized distributor.	■			
Check radiator airflow: Visually inspect the radiator through the guarding for blockage, debris or signs of wear or damage. To clean or replace, contact your authorized distributor.	■			
Check fuel lines and hoses: Visually check for leaks, worn or damaged hoses. To replace, contact your authorized distributor.	■			

Maintenance Items	After Every 24 Hours of Run Time <sup>1</sup>	After Every 50 Hours of Run Time	12 Months or After 250 Hours <sup>2</sup>	2 Years or After 500 Hours <sup>2</sup>
Check engine oil level: If low, top up to engine specifications level with recommended oil.	■			
Check charge alternator: Check visually and audibly when the generator set is running. To replace, contact your authorized distributor.	■			
Check all exhaust components and hardware (fittings, clamps, fasteners, etc.): Visually inspect the exhaust system for signs of wear or damage. Check audibly when the generator set is running.	■			
Check generator set enclosure: Visually check enclosure. Make sure no inlets/outlets are restricted, service access doors are operational. To replace damaged parts, contact your authorized distributor.	■			
Check operation of operator panel: Check display (the system will perform a control panel test on initial activation). Replace component if not functioning properly.	■			
Check operation of Emergency Stop Button (where fitted): With the generator set running, press the Emergency Stop button. Check all systems before resetting the fault.		■		
Replace air cleaner.			■ <sup>3</sup>	
Check coolant lines and radiator hoses for leaks, wear and cracks: Visually check the hoses. Replace worn or damaged components.			■	
Clean radiator core.			■ <sup>3</sup>	



Maintenance Items	After Every 24 Hours of Run Time <sup>1</sup>	After Every 50 Hours of Run Time	12 Months or After 250 Hours <sup>2</sup>	2 Years or After 500 Hours <sup>2</sup>
Check water pump for leaks. Check weep holes for evidence of leaks. Replace if leaking.			■	
Verify that the coolant heater has power and is running (where fitted). Check for evidence of leaks. Remove any corrosion from fittings.			■	
Check CCV heater (where fitted). Check for evidence of leaks. Remove any corrosion from fittings.			■	
Check alternator heater (where fitted). Check general condition and wiring connections.			■	
Check battery heater (where fitted). Check general condition and wiring connections.			■	
Check engine oil heater (where fitted). Check general condition and wiring connections.			■	
Check battery: Check connections to verify that they are secure.			■	
Check battery for general condition. Remove any corrosion on terminals with wire brush.			■	
Check electrical connections (battery, starter motor, alternator connections). Check for tight connections, general condition and remove any corrosion.			■	
Replace engine oil and filters. Refer to the Engine Oil section for the procedure.		■ <sup>4</sup>	■ <sup>4</sup>	
Check engine ground. Clean as necessary.			■	

Maintenance Items	After Every 24 Hours of Run Time <sup>1</sup>	After Every 50 Hours of Run Time	12 Months or After 250 Hours <sup>2</sup>	2 Years or After 500 Hours <sup>2</sup>
Check engine mounts for general condition and for signs of excessive wear.			■	
Check starting motor.			■	
Check turbocharger for signs of leakage. Listen for excessive noise when test running the generator set.			■	
Inspect spark plugs. Replace if showing signs of excessive wear, carbon deposits, oil accumulation or damaged.			■	
Replace spark plugs and spark plug wires.				■
Check charge air cooler for damage and debris.			■	
Check valve lash and adjust if required. See the Valve Clearance Adjustment procedure (service manual only).				■
Check fan drive idler arm and fan belt tensioner for general condition, as well as for excessive play in both.				■
Replace cooling system coolant.				■
<sup>1</sup> This interval is based on generator run time: daily in an outage or after every 24 hours of run time. <sup>2</sup> To be performed by a qualified Service Technician. <sup>3</sup> Cleaning schedule may be reduced depending on operating conditions/environment. <sup>4</sup> After the initial 50 hour interval and every 250 hours thereafter.				

## 6.3 Exercising the Generator Set

### NOTICE

**Audible engine RPM variation may be heard when there is no load applied. This is normal and does not affect the generator set performance.**

Exercising the generator set drives off moisture, relubricates the engine, and removes oxides from electrical contacts. The result is better starting, more reliable operation and longer engine life.

The generator set exerciser mode defaults are as follows.

- Day: Tuesday
- Time: 2:00 pm
- Period: Monthly
- Run Time: 5 minutes

Refer to the [Exercise Settings](#) section of this manual for more information on setting up the exerciser.

## 6.4 Engine Oil

### Recommended Engine Oil

Check the oil level prior to starting the generator set to verify that the oil level is between the High and Low marks. The generator set is shipped with engine oil.

The use of quality engine oils combined with appropriate oil and filter change intervals are critical factors in maintaining engine performance and durability.

Cummins Power Generation recommends the use of a high quality SAE 5W-40 GEO (all ambients) or SAE 15W-40 GEO (above 40 °F [4 °C]) engine oil for natural gas and propane engines. In addition, oil needs to conform with CES 20074. Refer to the Model Specifications section for oil specification details.

#### NOTICE

**Use of improper oils can result in engine damage. Use only the recommended oils.**

#### NOTICE

**Use of GEO 15W-40 oil in ambient temperatures below 40 °F (4 °C) could result in engine turbocharger damage.**

### Checking Engine Oil Level

#### WARNING

##### ***Hot Surfaces***

***Contact with hot surfaces can cause severe burns. Wear appropriate PPE when working on hot equipment and avoid physical contact with hot surfaces.***

**⚠ WARNING****Toxic Hazard**

***State and federal agencies have determined that contact with used engine oil can cause cancer or reproductive toxicity.***

***Avoid skin contact and breathing of vapors. Use rubber gloves and wash exposed skin. Accidental or remote starting of the generator set can cause severe personal injury or death. Disconnect the negative (-) battery cable and place the control switch in its OFF position before starting work.***

**⚠ WARNING****Toxic Hazard**

***Crankcase pressure can blow out hot oil and cause severe burns.***

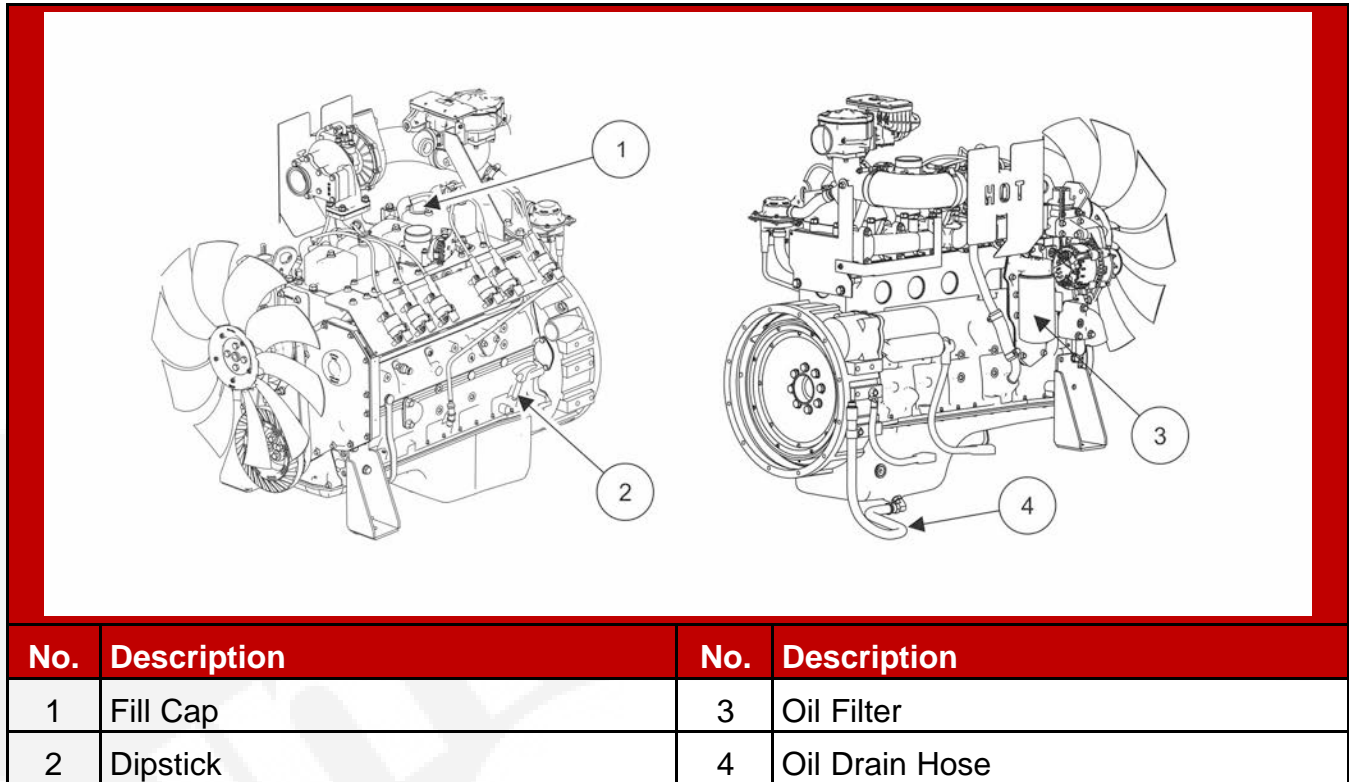
***Do NOT check oil while the engine is operating.***

**NOTICE**

**Check the engine oil level when the engine is not running and is out of Auto mode.**

**NOTICE**

**Overfilling can cause foaming or aeration of the oil, and operation below the low mark may cause loss of oil pressure. Do not operate the engine with the oil level below the low mark or above the high mark.**



**FIGURE 38. ENGINE OIL COMPONENTS**

To check the engine oil level:

1. Make sure that the engine has not been running for approximately five minutes.
2. Clean off the area surrounding the dipstick port to prevent entry of debris into the oil pan.
3. Pull out the dipstick and wipe it clean.
4. Reinsert and fully seat the dipstick.
5. Remove the dipstick and check the oil level.

**NOTICE**

**The engine oil level indicated on the dipstick should be between the High (15 qt [14.2L]) and Low (13 qt [12.4L]) marks.**

6. Reinsert and fully seat the dipstick.

If the engine oil level check shows excessive or insufficient levels of oil (that is, oil level line above the High mark or below the Low mark), oil must be drained or added. Refer to the following sections for instructions and guidelines for draining and adding oil.

## Adding or Draining Oil

### WARNING

#### **Hot Surfaces**

**Contact with hot surfaces can cause severe burns. Wear appropriate PPE when working on hot equipment and avoid physical contact with hot surfaces.**

### WARNING

#### **Hot Engines**

**Contact with hot engines can cause severe burns. Ensure that the generator set engine has cooled down before adding or draining the oil.**

### NOTICE

**Too much oil can cause high oil consumption. Too little oil can cause severe engine damage. Keep the oil level between the High and Low marks on the dipstick.**

### Adding Oil

If the oil level is found to be insufficient, oil must be added.

1. Ensure that the oil fill cap area is clean, and prevent debris from entering the engine.
2. Add the appropriate amount of oil, based on the engine oil level check.
3. Recheck the engine oil level. Based on the results, add or drain oil.
4. Clean up and dispose of any oil in accordance with local/state regulations.

### Draining Oil

If the oil level is found to be excessive, oil must be drained from the engine.

1. Detach the oil drain hose from the side of the engine.
2. Place the end of the drain hose into an appropriate container.

Refer to local regulations to determine the appropriate container for used oil.

- Open the oil drain valve to release oil from the engine into the appropriate container.
- Recheck the engine oil level. Based on the results, add or drain oil.
- When a sufficient amount of oil has been drained from the system:
  1. Close the oil drain valve.
  2. Wipe the oil drain valve clean.
  3. Re-attach the drain hose to the side of the engine.
  4. Dispose of the used oil in accordance with local/state regulations.

## Changing Engine Oil and Oil Filter

### WARNING

#### **Toxic Hazard**

*State and federal agencies have determined that contact with used engine oil can cause cancer or reproductive toxicity.*

*Avoid skin contact and breathing of vapors. Use rubber gloves and wash exposed skin. Accidental or remote starting of the generator set can cause severe personal injury or death. Disconnect the negative (-) battery cable and place the control switch in its OFF position before starting work.*

### NOTICE

If the oil and/or oil filter are not reused, dispose of them in accordance with local environmental regulations.

### NOTICE

Change the engine oil and filter when the engine is not running and is out of Auto mode.

### NOTICE

Change the oil more often in hot and dusty environments.

### NOTICE

CPG highly recommends that any service or maintenance work be performed by qualified technicians.

1. Before changing the oil, the generator set should be operated until the water temperature is approximately 140 °F (60 °C).
2. Turn off the generator set.
3. Drain the oil.
4. Remove the oil filter, and clean the filter mounting surface on the engine block. Remove the old gasket if it remains.
5. Make sure the gasket is in place on the new filter and apply a thin film of clean oil to the gasket. Install the new filter until the gasket just touches the block. Turn it an additional 1/2 to 3/4 turn. Do not over-tighten.
6. Close the oil drain valve.
7. Refill with oil until full.

### NOTICE

Too much oil can cause high oil consumption. Too little oil can cause severe engine damage. Keep the oil level between the High and Low marks.

8. Operate the engine at idle to inspect for leaks at the lubricating oil filter and the drain plug.
9. Confirm that the correct oil level is in the pan:
  - a. Shut the generator set off and wait 5 minutes.
  - b. Check the engine oil level.
10. Check and repair any leaks identified.
11. Dispose of the used oil and oil filter according to local environmental regulations.

## 6.5 Air Intake System

### Normal Duty Air Cleaner Replacement

#### NOTICE

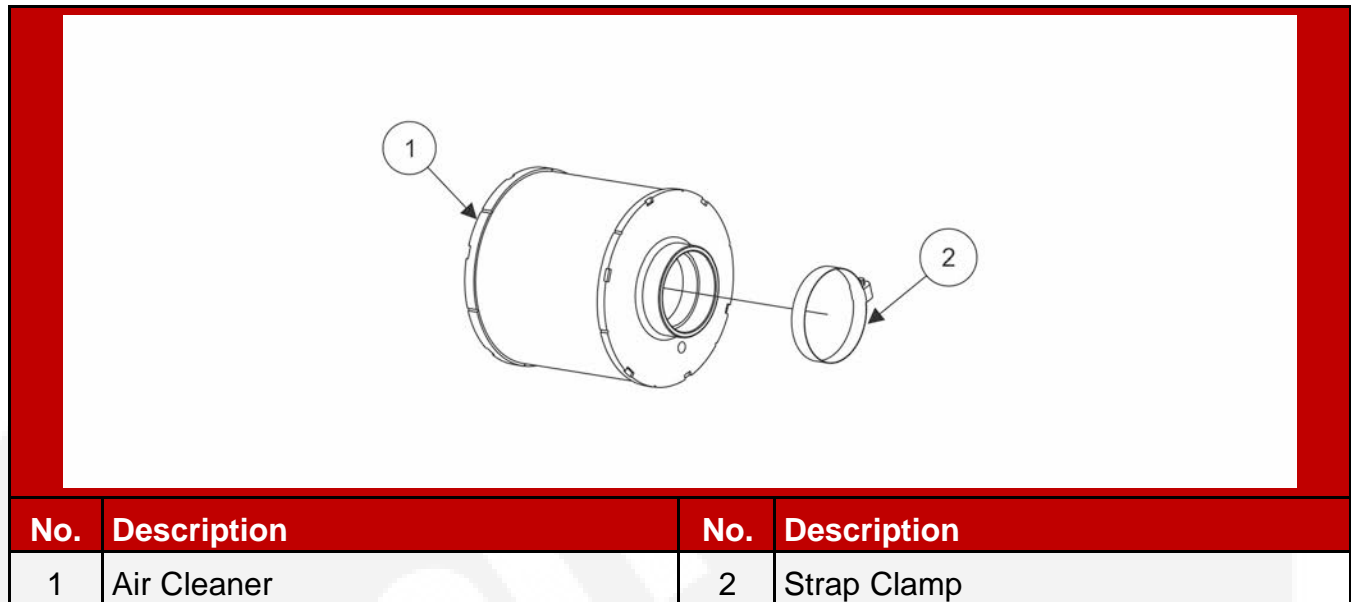
Holes, loose-end seals, dented sealing surfaces, corrosion of pipes, and other forms of damage render the air cleaner inoperative and require immediate element replacement or engine damage can occur.

#### NOTICE

Cummins Inc. does not recommend cleaning paper-type air cleaner elements.

1. Remove the existing air cleaner:
  - a. Loosen the strap clamp (2).
  - b. Wipe away any debris accumulated around the air cleaner connection to the engine. Ensure that no debris is allowed to enter the body of the air cleaner or the connection on the engine.
  - c. Remove the dirty cleaner (1).
  - d. Dispose of the dirty element in accordance with local environmental agency requirements.
2. Install the replacement air cleaner (1) as follows:
  - a. Install the air cleaner (1).
  - b. Tighten strap clamp (2). Torque to 2.5 - 3.3 ft-lb (4.3 - 4.65 Nm).





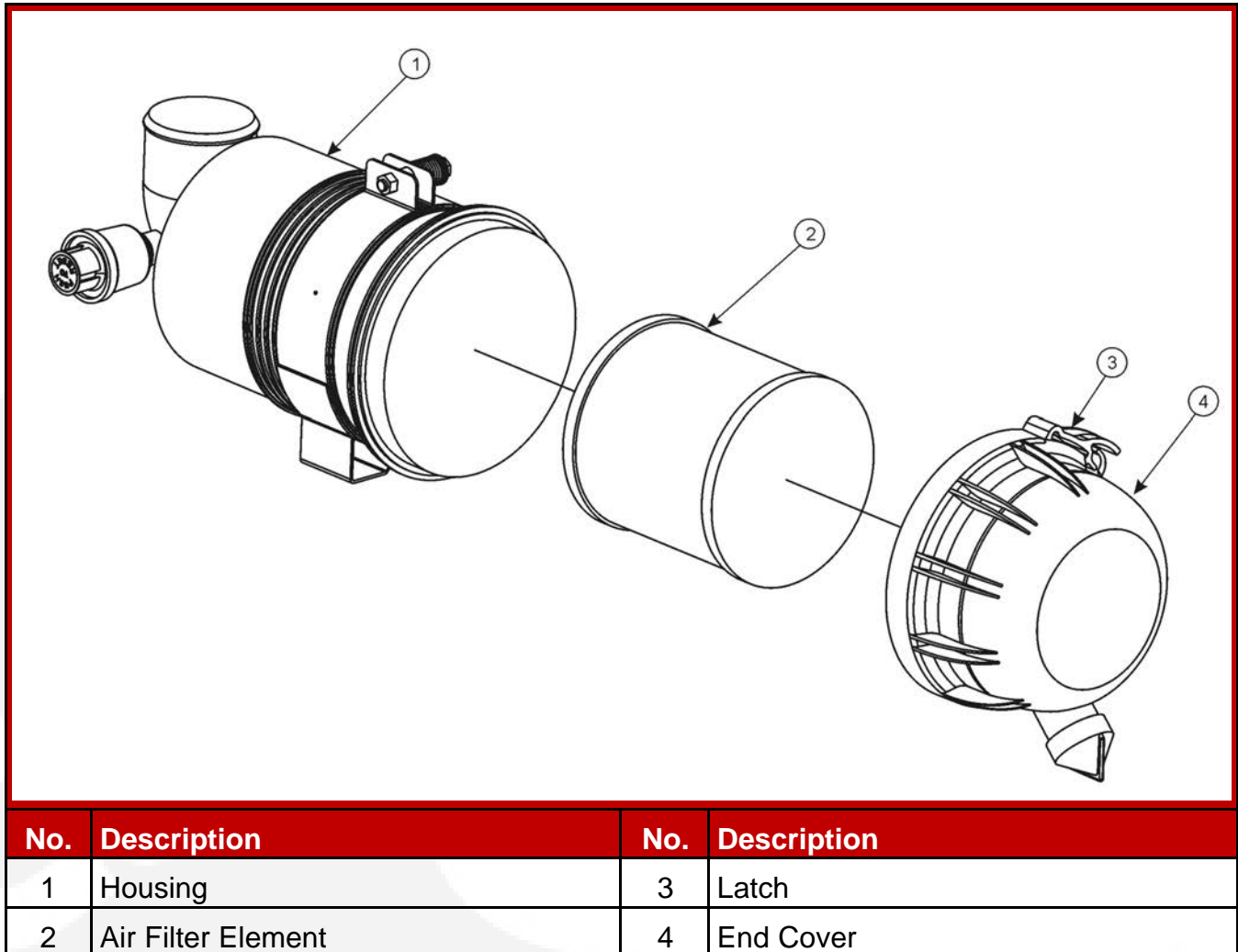
**FIGURE 39. NORMAL DUTY AIR CLEANER**

## Heavy Duty Air Cleaner Element Replacement

### NOTICE

**Cummins Inc. does not recommend cleaning paper-type air cleaner elements.**

1. To remove the existing air cleaner element:
  - a. Before disassembly, wipe dirt from the cover and the upper portion of the air cleaner.
  - b. Lift the latch (3) and turn the end cover (4) counterclockwise.
  - c. Pull the end cover (4) away from the housing (1).
  - d. Remove the air filter element (2) from the housing (1).
  - e. Dispose of the dirty element in accordance with local environmental agency requirements.
2. To install the replacement air cleaner element:
  - a. Ensure that no debris enters the filter element or connection point on the air cleaner housing.
  - b. Insert the air filter element (2) into the housing (1).
  - c. Install the end cover (4) onto the housing (1).
  - d. Turn the end cover (4) clockwise until the latch (3) snaps into place.



**FIGURE 40. HEAVY DUTY AIR CLEANER**

## 6.6 Batteries

Batteries are an essential part of any standby generator system. A significant amount of generator set failures are due to battery issues.

It is therefore vital that batteries are stored, commissioned, and maintained as detailed here. Reference should also be made to the battery manufacturer's instructions.

Maintenance free batteries supplied with the generator need no maintenance for commissioning.

### Storage

Dry-charged batteries should be stored in a cool, dry place, upright and with the vent caps securely in place.

Filled and charged batteries must be stored in a cool, dry, well-ventilated place. Make sure that the vent caps are securely screwed down or pushed home.

Batteries must never be stacked on top of each other and must be protected from the floor by a wooden pallet or suitably thick cardboard sheet.

## Safety Precautions

Handling and proper use of batteries is not hazardous if the correct precautions are observed and personnel are trained in their use.

### General Precautions

#### WARNING

##### ***Arcing Hazard***

***Laying tools or metal objects across the battery can cause arcing that may ignite battery gases causing explosions resulting in personal injury.***

***Never lay tools or metal objects across the top of the battery.***

#### NOTICE

Use tools with insulated handles to prevent the risk of electric shock.

#### NOTICE

Keep batteries upright to prevent spillage.

#### CAUTION

##### ***Toxic Hazard***

***Electrolyte is a dilute sulphuric acid that is harmful to the skin and eyes. It is electrically conductive and corrosive.***

***Wear full eye protection and protective clothing. If electrolyte contacts the skins, wash it off immediately with water. If electrolyte contacts the eyes, flush thoroughly and immediately with water and seek medical attention. Wash spilled electrolyte with an acid neutralizing agent.***

### Fire Hazard

#### WARNING

##### ***Combustible Gases***

***During the charging of a battery, explosive gases are given off.***

***Do not smoke near the battery. Keep the battery well ventilated and away from naked flames and sparks.***

**⚠ CAUTION****Fire Hazard**

*Lead acid batteries present a risk of fire because they generate hydrogen gas.*

*Do not smoke near the batteries. Do not cause flame or spark in the battery area. Discharge static electricity from your body before touching batteries by first touching a grounded metal surface.*

**NOTICE**

Make sure that batteries are charged in a well ventilated area, away from naked flames and sparks.

**NOTICE**

Before disconnecting a battery, always remove power from the AC powered battery charger (where fitted) BEFORE disconnecting the charger leads.

**NOTICE**

When putting a battery into service on a generator set, connect the negative lead LAST; when removing the battery, disconnect the negative lead FIRST.

**Vented Batteries****⚠ CAUTION****Combustible Liquid**

*The electrolyte in vented batteries is a dilute sulfuric acid that is harmful to the skin and eyes. It is also electrically conductive and corrosive.*

*Always:*

- 1. Wear full eye protection and protective clothing;*
- 2. If electrolyte contacts the skin, wash it off immediately with water;*
- 3. If electrolyte contacts the eyes, flush thoroughly and immediately with water and seek medical attention; and*
- 4. Wash spilled electrolyte down with an acid neutralizing agent. A common practice is to use a solution of one pound (500 grams) bicarbonate of soda to one gallon (4 liters) of water. Continue to add the bicarbonate of soda solution until the evidence of reaction (that is, foaming) has stopped. Flush the resulting liquid with water and dry the area.*

## Battery Maintenance

### WARNING

#### ***Automated Machinery***

***Accidental or remote starting of the generator set can cause severe personal injury or death. Arcing at battery terminals or in light switches or other equipment, and flames or sparks can ignite battery gas causing severe personal injury.***

***Always follow these procedures to avoid injury and/or damage:***

- ***Ventilate the battery area before working on or near the battery.***
- ***Wear safety glasses.***
- ***Do not smoke.***
- ***Switch a work light on or off away from the battery.***

***Before starting work on the generator set, make sure:***

- ***The generator set is in Off mode.***
- ***The battery charger is disabled (if applicable).***
- ***The negative (-) battery cable has been removed first from the battery to prevent starting.***
- ***Once work is complete, reconnect the negative (-) battery cable last.***

Replace the battery charger if the battery keeps running down.

Always:

- Keep the battery case and terminals clean and dry and the terminals tight.
- Remove battery cables with an insulated wrench or battery terminal puller.
- Make sure which terminal is positive (+) and which is negative (-) before making battery connections, always removing the negative (-) cable first and reconnecting it last to reduce arcing.

### NOTICE

**If the battery needs to be replaced, make sure that the replacement battery specifications match those found in the Model Specifications in this manual.**

## Battery Replacement

**⚠ WARNING**

***Combustible Liquid***

***Burning the battery may cause an explosion. Damage to the casing will release electrolytes which is harmful to the skin and eyes.***

***When disposing of a battery, do not mutilate or burn it. Comply with all local health and safety regulations/codes during handling or disposal.***

Always replace the starting battery with the same number and type (e.g. vented, lead acid, maintenance free). Properly dispose of battery in accordance with local environment agency requirements .

## 6.7 Spark Plugs

**NOTICE**

**Make sure service personnel are qualified to perform electrical and mechanical service.**

The generator set has six spark plugs, all accessible from the top of the engine. The spark plugs must be in good condition for proper engine starting and performance. A spark plug that fouls frequently or has heavy soot deposits indicates the need for engine service.

1. Set the generator set control to the Off position before checking the spark plugs.
2. To prevent cross-threading a spark plug, always thread it in by hand until it seats. Torque the spark plug to 28 lb-ft (32 Nm).
3. Return the generator set control to the desired setting when finished performing maintenance.

# 7 Troubleshooting

---

The following list of codes is not an all inclusive list. For more information about the fault codes listed or for additional codes, contact your local dealer.

## NOTICE

**Make sure service personnel are qualified to perform electrical and mechanical service.**

## 7.2 Engine Is Difficult to Start or Does Not Start

### **Possible Causes:**

1. Battery voltage problem(s)
2. Fuel system issue(s)
3. Air intake restriction above specification

### **Diagnosis and Repair:**

1. Battery voltage problem(s)
  - a. If battery voltage is low, interrupted, or open, check:
    - Battery connections
    - Unswitched battery supply circuit
    - Fuses
2. Fuel system issue(s)
  - a. Verify that the manual fuel shutoff valve is open.
3. Air intake restriction above specification
  - a. Inspect air filter for obstruction. Replace if necessary.

## 7.3 Code 143 - Engine Oil Pressure Low (Warning)

### **Logic:**

Engine oil pressure is below the low oil pressure warning threshold.

### **Possible Cause:**

1. Lubricating oil level is low
2. External leak

### **Diagnosis and Repair:**

1. Lubricating oil level is low.
  - a. Check the oil level. Add oil, if necessary.

2. External leak.
  - a. Inspect the engine and surrounding area for external oil leaks.
  - b. Contact your local dealer if a leak is present.

## 7.4 Code 151 - Engine Coolant Temperature High (Shutdown)

### **Logic:**

Engine coolant temperature has exceeded the alarm (shutdown) threshold for high coolant temperature.

### **Possible Cause:**

1. High ambient temperature
2. Enclosure air intake blocked
3. Coolant level is below specification
4. Radiator blocked
5. Enclosure air discharge blocked
6. Fan belt is broken or loose
7. Coolant level is below specification

### **Diagnosis and Repair:**

1. High ambient temperature
  - a. Reduce loads or recirculation of discharge air to generator in elevated ambient.
2. Enclosure air intake blocked
  - a. Inspect for dirt, debris, or obstructions.
  - b. Remove blockage or snow/ice buildup as applicable.
3. Coolant level is below specification
  - a. Check coolant level.
  - b. Add coolant as necessary
4. Radiator blocked
  - a. Inspect for dirt, debris, or obstruction.
  - b. Remove blockage or winterfront as applicable.
5. Enclosure air discharge blocked
  - a. Inspect for dirt, debris, or obstructions.
  - b. Remove blockage or snow/ice buildup as applicable.
6. Fan belt is broken or loose
  - a. Inspect belt(s) for damage, wear, and proper tension.



- b. Repair or replace if damaged or worn.
7. Coolant level is below specification
- a. Check coolant level.
  - b. Add coolant as necessary.

## 7.5 Code 155 - Intake Manifold Temperature High (Shutdown)

### **Logic:**

The engine intake manifold temperature has exceeded the temperatures below for greater than 10 seconds:

- Models C45 N6, C50 N6 and C60 N6: 167 °F (75 °C)
- Models C70 N6, C80 N6 and C100 N6: 176 °F (80 °C)

### **Diagnosis and Repair:**

For the troubleshooting procedure, refer to DTC 127 in the EControls Manual.

### **NOTICE**

The EControls manual applies to several applications. See the wiring diagrams provided with the generator set for appropriate pin numbers.

## 7.6 Code 197 - Coolant Level Low (Warning)

### **Logic:**

Coolant level sensor signal is showing a low coolant level for greater 10 seconds.

### **Possible Causes:**

1. Low coolant

### **Diagnosis and Repair:**

1. Low coolant
  - a. Remove radiator cap and check that coolant is up to the required level.

## 7.7 Code 415 - Engine Oil Pressure Low (Shutdown)

### **Logic:**

Engine oil pressure is below 26 psig (180 kpa) for greater than 10 seconds.

### **Possible Cause:**

1. Lubricating oil level is low

## 2. External leak

### ***Diagnosis and Repair:***

1. Lubricating oil level is low
  - a. Check the oil level. Add oil, if necessary.
2. External leak
  - a. Inspect the engine and surrounding area for external oil leaks.
  - b. Contact your local dealer if a leak is present.

## **7.8 Code 441 - Battery Voltage Low (Warning)**

### ***Logic:***

Battery voltage is low.

### ***Possible Causes:***

1. Loose or damaged battery cable connections
2. Battery charger not connected (if equipped)
3. Battery needs recharging

### ***Diagnosis and Repair:***

1. Loose or damaged battery cable connections.
  - a. Inspect the battery cable connections.
    - i. Inspect connections for corrosion.
    - ii. Inspect connections for loose connections.
2. Battery charger not connected (if equipped)
  - a. Make sure that the battery charger is connected to the AC power supply.
  - b. Make sure that the battery charger is connected correctly to the battery.
3. Battery needs recharging
  - a. Using a voltmeter or multimeter, determine if the voltage is below 11 V. If so, recharge the battery.

## **7.9 Code 488 - Intake Manifold Temperature High (Warning)**

### ***Logic:***

The engine intake manifold temperature has exceeded the temperatures below for more than 90 seconds:

- Models C45 N6, C50 N6 and C60 N6: 158 °F (70 °C)
- Models C70 N6, C80 N6 and C100 N6: 167 °F (75 °C)

**Possible Causes:**

1. High ambient temperature
2. Enclosure air intake blocked
3. Coolant level is below specification
4. Radiator blocked
5. Enclosure air discharge blocked
6. Fan belt is broken or loose

**Diagnosis and Repair:**

1. High ambient temperature
  - a. Reduce loads or recirculation of discharge air to generator in elevated ambient.
2. Enclosure air intake blocked
  - a. Inspect for dirt, debris, or obstructions.
  - b. Remove blockage or snow/ice buildup as applicable.
3. Coolant level is below specification
  - a. Check coolant level.
  - b. Add coolant as necessary.
4. Radiator blocked
  - a. Inspect for dirt, debris or obstructions.
  - b. Remove blockage or winterfront as applicable.
5. Enclosure air discharge blocked
  - a. Inspect for dirt, debris, or obstructions.
  - b. Remove blockage or snow/ice buildup as applicable.
6. Fan belt is broken or loose
  - a. Inspect belt(s) for damage, wear, and proper tension.
  - b. Repair or replace if damaged or worn.

## 7.10 Code 1438 - Fail to Crank (Shutdown)

**Logic:**

The engine failed to crank after the generator control received a start signal.

**Possible Cause:**

1. Dead or weak battery
2. Failed starter

**Diagnosis and Repair:**

1. Dead or weak battery
  - a. Verify battery voltage is at least 12 VDC (or 24 VDC if applicable).
  - b. Charge or replace the battery as necessary.
2. Failed starter
  - a. Press the Reset/Fault acknowledge button on the display.
  - b. Attempt to start the generator and test for B+ at the starter supply lug.
  - c. If B+ is present at the starter supply lug, the starter could be defective.

## 7.11 Code 1472 - High AC Current (Shutdown)

**Logic:**

The generator output current has exceeded at least 150% of rated current.

**Possible Causes:**

1. Generator set overload

**Diagnosis and Repair:**

1. Generator set overload.
  - a. Reduce the generator set load by powering off to unnecessary household appliances (examples: washer, dryer, air conditioning, etc.).

## 7.12 Code 5134 - Unknown Shutdown at Idle

**Logic:**

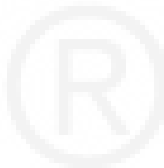
Engine is not getting a proper fuel supply.

**Possible Causes:**

1. Fuel supply issue

**Diagnosis and Repair:**

1. Fuel supply issue
  - a. Check that there is a proper supply of fuel to the engine.





[power.cummins.com](http://power.cummins.com)

Copyright © 2015 Cummins Power Generation Inc. All rights reserved. Cummins Power Generation, the "C" logo, and Cummins are registered trademarks of Cummins Inc. PowerCommand, AmpSentry, InPower and "Our energy working for you." are trademarks of Cummins Power Generation. Other company, product, or service names may be trademarks or service marks of others. Specifications are subject to change without notice.

