

ORIGINAL INSTRUCTIONS
RVMP-FlexPower 2200i Silent
Inverter Generator, Black
RVMP-220472
OPERATOR'S MANUAL



Read this manual carefully before operation.
This manual includes important guidance for safety operation.

This Manual contains important safety information and instructions for operating this generating set. **PLEASE READ THIS MANUAL CAREFULLY.**

Failure to do so could result in property damage and/or personal INJURY/DEATH.

Provide this manual to any operator of this generating set. This manual should be considered as a permanent part of your generating set and should remain with it when you sell it.

All pictures & figures are only one example of series generating set. It shall be only for reference and perhaps there will be difference between pictures & figures and physical products.

All information in this publication is based on the latest product information available at the time of printing. We reserve the right to change, alter and/or improve the product and this document at any time without notice and without incurring any obligation.

No part of this publication shall be reproduced without written permission.

Write down the generating set's serial number and purchase information. Keep this manual and the receipt for future reference.

Model:

Serial number:

Date of purchase:

Contents

I. Operator safety	1
1. Safety rules	1
II. Features and controls	6
III. Operating	10
1. Operating checklist	10
2. Starting the generating set.....	15
3. Connect to electrical devices	18
4. Stopping the generating set.....	20
5. Parallel operation	21
IV. Maintenance	22
1. Maintenance schedule	23
2. Generating set maintenance.....	24
3. Engine maintenance	24
V. Trouble-shooting	28
VI. Storage and transportation	29
VII. Specification	31
1. Specification parameter table	31
2. Wiring diagram.....	32

I. Operator safety

1. Safety rules



Pay attention to this safety alert symbol. Obey all safety messages that followed by this symbol to avoid possible property damage. INJURY or DEATH.

Each safety message is preceded by a safety alert symbol and one of three words, DANGER, WARNING, or CAUTION.

DANGER

Indicates a hazardous situation which, if not strictly complied with, will result in substantial property damage, serious injury or DEATH.

WARNING

Indicates a hazardous situation which, if not strictly complied with, may result in property damage, serious injury or DEATH.

CAUTION

Indicates a hazardous situation which, if not strictly complied with, could result in property damage or injury.



WARNING

READ THIS MANUAL COMPLETELY BEFORE OPERATING.

DO NOT operate this generating set until you have read ALL safety, Operation, and maintenance instructions listed in this manual.

Failure to follow the instructions may result in property damage, INJURY or DEATH.

The warnings and precautions discussed in this manual cannot cover all possible conditions and situations that may occur. It must be understood by the operator that common sense and caution are factors which cannot be built into this product, but must be possessed by the operator.

WARNING

This generating set is intended for residential consumer use only.

Air cooled generating sets cannot be run full time.

No personal-modified any part of the generating set or any unsuitable usage is allowed.



⚠ DANGER

TOXIC FUMES

The exhaust of the engine contains carbon monoxide, an odorless, colorless, poison gas. Using engine indoors **CAN KILL YOU!**

NEVER use inside any building or any kind of enclosure, **EVEN IF** doors and windows are open.

Place the engine in a well-ventilated area and carefully consider wind and air currents when positioning the engine.



⚠ WARNING

KICKBACK

Rapid retraction of the starter cord will pull hand and arm towards the engine faster than you can let go.

Unintentional startup can result in entanglement, traumatic amputation or laceration. Broken bones, fractures, bruises or sprains.



⚠ WARNING

FIRE

Operation of this engine may create sparks that can start fires around flammable material.

This engine may not be equipped with a spark arresting muffler. If the engine will be used around flammable materials, or on land covered with materials such as agricultural crops, forest, brush, grass, or other similar items, then an approved spark arrester must be installed.

In some area, a spark arrester is required by law.

Please contact local fire agencies for laws or regulations relating to fire prevention requirements.



Flammable materials can catch fire when they come into contact with hot surfaces. Do not place flammable objects within 1.5 meters.



WARNING

HOT SURFACE

Running engines produce heat. Severe burns can occur on contact.

DO NOT touch engine while operating or just after stopping. Avoid contact with hot exhaust gases.

WARNING

Lithium battery is maintenance free, if you have any question, please contact a local authorized dealer.



DANGER

FIRE OR EXPLOSION

Gasoline is highly flammable and extremely explosive.

Fire or explosion can cause severe burns or death.

Keep flammable items away while handling gasoline.

Fill fuel tank outdoors and in a well-ventilated area with the engine stopped.

Always wipe off spilled fuel and wait until the fuel has dried before starting the engine.

DO NOT operate the engine with known leaks in the fuel system.

Use proper fuel storage and handling procedures.

DO NOT store fuel or other flammable materials nearby.

Empty the fuel tank before storing or transporting this engine.

Keep fire extinguisher handy and be prepared if a fire starts.

⚠️ WARNING

Before each use, check for loose or damaged parts, signs of oil or fuel leaks, and any other condition that may affect proper operation.

Repair or replace all damaged or defective parts immediately.

Locate all operating controls and safety labels.

Make sure all the safety instructions are in right and working condition. Operate only on level surfaces.

DO NOT expose generating set to excessive moisture, dust, or dirt.

Keep all safety guards in place and in proper working order at all times.

DO NOT allow any material to block the cooling slots.

DO NOT allow children or untrained persons to operate the generating set.

DO NOT run the generating set unattended. Turn off the generating set before leaving the area.

Allow 0.9 meter of space around the generator to ensure good cooling.



⚠️ DANGER

MOVING PARTS

Moving parts can cause severe injury. Keep hands and feet away.

DO NOT operate engine with covers, shrouds, or guards removed.

DO NOT wear loose-fitting clothing, dangling drawstrings or items that could become caught. Tie up long hair and remove jewelry.

The moving parts may catch operator's hand, feet, hair or clothes that will cause traumatic amputation or broken bones, fracture.

NEVER place fingers, hands, or body near the engine when it is running.



⚠ DANGER

ELECTRIC SHOCK

This generating set produces powerful voltage and the electricity **CAN KILL YOU**.

This generating set must be properly connected to an appropriate ground to help prevent electric shock.

Failure to properly ground generating set can result in electrocution, especially if the generating set is equipped with a wheel kit.

Consult an electrician for local grounding requirements.

Installation should be performed by a certified electrician.

Improper Installation can result in electric shock and death.

To reduce the risk of electric shock. **DO NOT** use electrical cords that are worn, frayed, bare or otherwise damaged.

DO NOT touch bare wires or receptacles.

DO NOT operate generating set in wet weather. Keep the

generating set dry.

DO NOT handle generating set or electrical cords while standing in water, while barefoot, or while hands or feet are wet.

Keep children or pets away from the generating set.

DO NOT hook up any generating set to a building electrical system without the proper use and installation of a transfer switch installed by a qualified electrician.

When using generating set for backup power, notify utility company. Use approved transfer generating set to isolate generating set from electric utility.

Failure to isolate generating set from power utility can result in death or injury to electric utility workers due to backfeed of electrical energy.

II. Features and controls (applicable model)

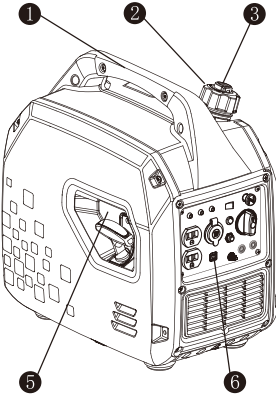

- ① Carrying handle
- ② Fuel tank cap
- ③ Ventilation knob
- ④ Spark plug maintenance cover
- ⑤ Recoil starter

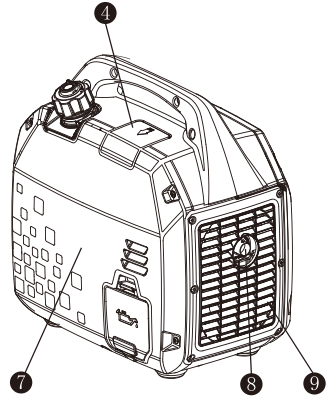

- ⑥ Control Panel
- ⑦ Appearance cover
- ⑧ Muffler
- ⑨ Muffler blind window

Control Panel

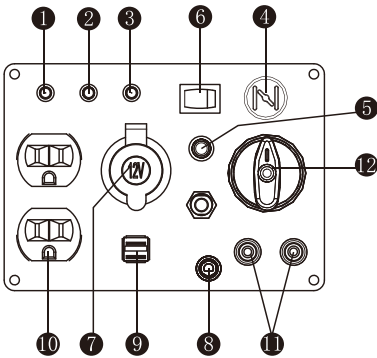

- ① Running indicator
- ② Overload indicator
- ③ Oil alarm lamp
- ④ Choke lever
- ⑤ Reset button
- ⑥ Energy-saving switch
- ⑦ 12V DC
- ⑧ Ground terminal
- ⑨ USB port
- ⑩ Receptacle
- ⑪ Parallel kit terminal
- ⑫ Two-in-one switch (engine stop & fuel switch)

Running indicator (green)

The running indicator lights up when generating set starts and has normal output.

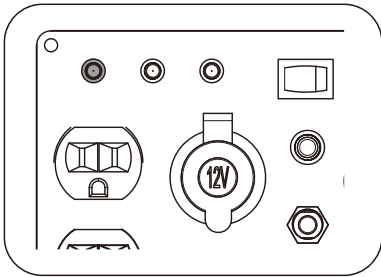

Overload indicator (red)

When the overload indicator is on, it indicates that the generating set is overload and it may cause overheat of frequency converter, or increase of AC voltage. And then the AC protector works. It will stop the output of generating set to protect the electric equipment and the generating set itself. At this time, the running indicator (green) is off and the overload indicator (red) is on, but the engine is still in running state.

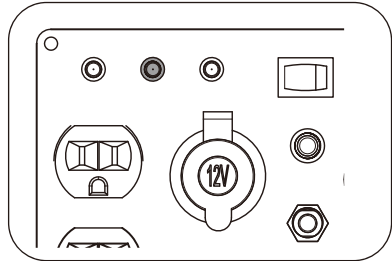

When the generating set has no output and the overload indicator is on, please take the following steps:

1. Lower the total power of the connected electric devices to the rated output range of generating set.
2. Check the air intake for impurities and check the control parts for abnormal situation. Handle immediately if necessary.
3. Press the reset button.

Oil alarm lamp (yellow)

When the oil level drops below the lower limit, the oil protection system will stop the engine automatically and oil alarming lamp will blink by pulling the recoil starter. The engine will not run until the oil has been filled to the proper level.

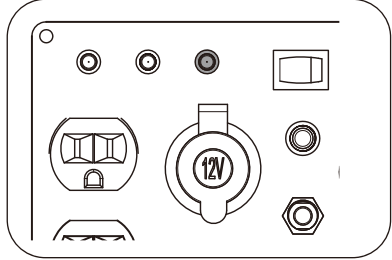

Note: If engine flames out or fails to start, turn the two-in-one switch to “RUN” position and then pull the recoil starter. If the oil alarming lamp lights up, it shows lack of oil. Please add appropriate oil and restart the engine.

Choke lever

Note: when cold start, please close (pull) the choke lever. When warm start, please open (push) the choke lever.

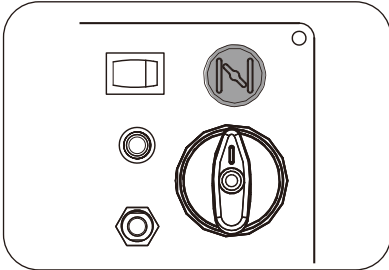

Energy-saving switch

When the energy-saving switch is in “ON” position, the energy saving equipment controls the engine rotate speed according to the connected loads. There will be good fuel consumption and low noise.

When the energy-saving switch is in “OFF” position, the engine will always run in rated rotate speed no matter it is connected to the loads or not.

Note: Please set the energy-saving switch to “OFF” position when connect to air compressor, sinking pump etc., because these equipments need large starting current.

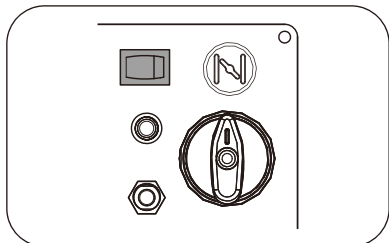

Grounding terminal

The grounding terminal is designed to prevent electric shock by connecting it to the grounding wire. The generating set must be properly grounded before operation.

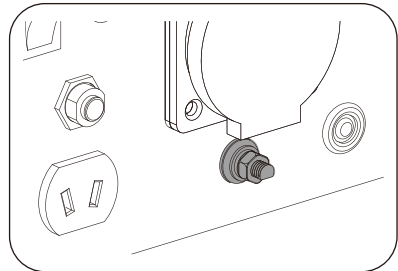

Two-in-one switch (engine stop & fuel switch)

When the switch is in “OFF” position, it indicates that the engine stop switch and fuel switch are in off state.

When the switch is in “RUN” position, it indicates that the engine stop switch and fuel switch are in on state.

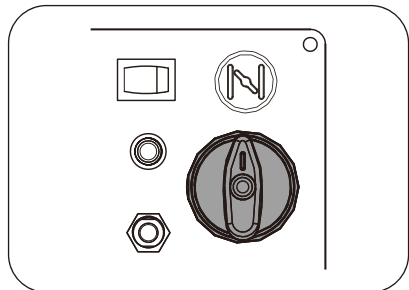

Reset button

The reset button is used to restore output if an overload occurs. To restore output,

reduce the loads and press the reset button.

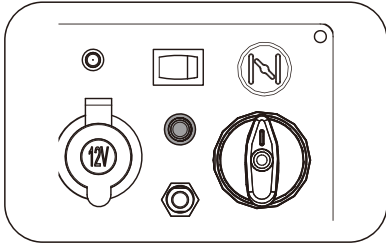

Circuit breaker

The circuit breaker protects the generating set against electrical overloads.

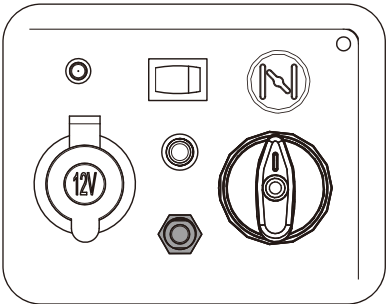

Parallel kit terminal

It is used for parallel operation with another inverter (parallel kit sold separately).

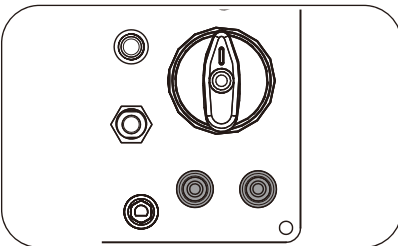

Push-button start

(If applicable)

You can start the generator by pressing the button with your finger.

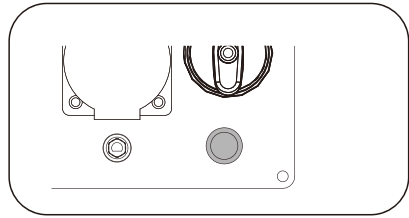

Fuel tank cap

Remove the fuel tank cap by rotating it anticlockwise.

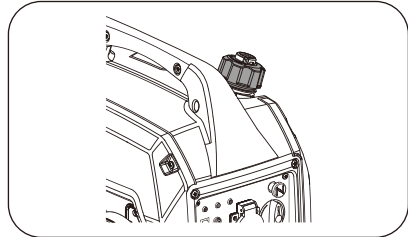

Ventilation knob

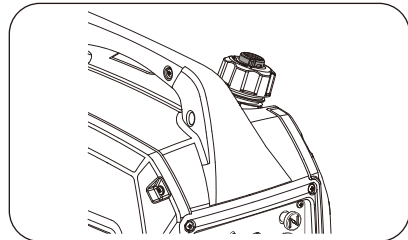

The fuel tank cap is equipped with the ventilation knob to prevent leakage of fuel. The ventilation knob must in "ON" position when operating generating set. Because this makes the fuel be injected to the carburetor and drive the engine. To avoid fuel leakage, turn it in "OFF" position when carrying or not use the generating set.

III. Operating

1. Operating checklist

1 Operating Location

Only use OUTSIDE and place the generating set in a well-ventilated area.

Only operate the generating set on a flat, level surface and in a clean, dry operating environment.

Allow two feet clearance on all side of the generating set while operating it outdoors.

Operate in specified area, if any problem on applicable occasion, please consult the authorized local authority. In some areas, generating set must be registered with the local utility. Generating set used to construction sites may be subject to additional rules and regulations.



⚠ DANGER

TOXIC FUMES

The exhaust of the generating set contains carbon monoxide, Using engine indoors **CAN KILL YOU!**

NEVER use inside any building or any kind of enclosure, **EVEN IF** doors and windows are open.

Place the generating set in a well-ventilated and clean area. Note the wind direction

and air current when place the engine.

High altitude

This generating set may require a high altitude carburetor kit to ensure correct operation at high altitudes. Consult the authorized local dealer for high altitude kit information if you always operate your engine at altitudes above 5, 000 feet (1,500 meters).

⚠ CAUTION

Even with carburetor modification, generating set horsepower will decrease about 3.5% for each 1,000 feet (300 meters) increase in altitude. The effect of altitude on horsepower will be greater than this if no carburetor modification is made.

⚠ CAUTION

Operation the engine at altitude below 5, 000 feet (1,500 meters) with modified carburetor may cause the generating set to overheat and result in serious engine damage. Please restore factory specifications of the carburetor at the dealer when using the engine in a low altitude area.

2 Operating Condition

Check for loose or damaged parts, signs of oil or fuel leaks, and any other condition that may affect proper operation.

Repair or replace all damaged or defective parts immediately.

⚠ WARNING

Failing to correct problem(s) before operation could result in property damage, serious injury or DEATH.

Remove any excessive dirt or debris, especially around the muffler and recoil starter.
DO NOT move or tip the generating set during operation.
Use generating set only for intended uses. If you have questions about intended use, ask your local dealer.

3 Engine oil check

Place the engine on a level surface with engine stopped.
Check the engine oil level.
Remove the oil maintenance cover.

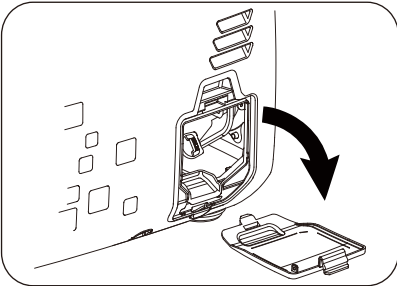

Remove the dipstick and wipe it clean.

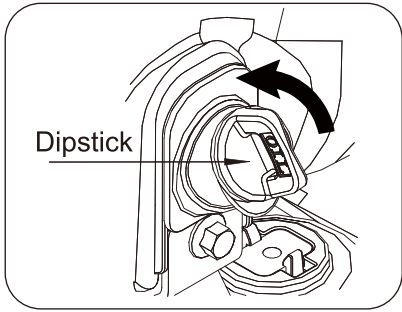

Reinstall dipstick into hole; rest on oil fill neck, DO NOT thread cap into hole.

Remove the dipstick again and check oil level. Level should be between the upper and lower limit.

Fill to the upper limit of the dipstick with the recommended oil if the oil level is too low.

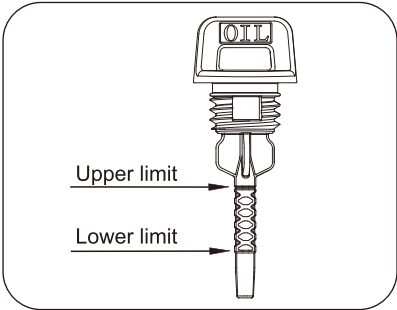
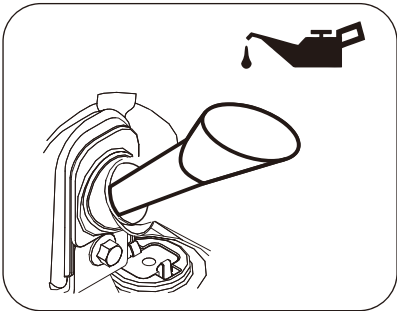

Reinstall and fully tighten the dipstick.

Reinstall the oil maintenance cover.

Refer to **add oil** instruction in **MAINTENANCE** section for more information.

Oil capacity(rated):

See Parameters

⚠ WARNING

Oil is a major factor affecting performance and service life. Use 4-stroke automotive detergent oil recommended in the **MAINTENANCE** section of this manual.

⚠ CAUTION

Operate generating set only on leveled surfaces. The engine is equipped with a low oil sensor (applicable types) that will automatic stop the engine when the oil level falls below the safe limit. To avoid the inconvenience of an unexpected shutdown, fill to the upper limit and check the oil level regularly.

⚠ WARNING

This engine is not filled with oil before send out to the factory. Any attempt to crank or start the engine before it has been properly filled with the recommended type and amount of oil may result in engine damage and void your warranty.

4 Generating set fuel check

With the engine stopped, check the fuel level. Refill the fuel tank if necessary.

Use clean, fresh, regular unleaded gasoline.

DO NOT mix oil with gasoline.

Always wipe up any spilled fuel.

⚠ CAUTION

Pressure can build up in the fuel tank. Allow the generating set to cool for at least two minutes before removing fuel cap.

Loosen the fuel cap slowly to relieve any pressure in the tank.

Be sure not to fill above the upper limit mark. Always allow room for fuel expansion.

Fuel capacity (rated):

See parameters.



⚠ DANGER

FIRE OR EXPLOSION

Gasoline is highly flammable and extremely explosive.

Keep flammable items away while handling gasoline.

Fill fuel tank outdoors and in a well-ventilated area with the generating set stopped.

Always wipe off spilled fuel and wait until the fuel has dried before starting the generating set.

DO NOT operate the generating set with known leaks in the fuel system. Regularly check if there is any leak on fuel system.

Use proper fuel storage and handling procedures. DO NOT store fuel or other flammable materials nearby.

Keep fire extinguisher handy and be prepared if a fire starts.

NEVER use engine or carburetor cleaner products in the fuel tank or permanent damage may occur.

It is important to prevent gum deposits from forming in essential fuel system parts, such as the carburetor, fuel filter, fuel hose or tank during storage. Also, experience indicates that alcohol-blended fuels (called gasohol, ethanol or methanol) can attract moisture, which leads to separation and formation of acids during storage.

Acidic fuel can damage the fuel system of the generating set while in storage. Be sure to review the instructions given in “Storage” section.

Gasoline/Alcohol blends: up to 10% alcohol, 90% unleaded gasoline by volume is approved as a fuel. Other gasoline/alcohol blends are not approved.

Effects of old, stale or contaminated fuel are not warrantable.

⚠ WARNING

Do not fill the fuel tank above the upper limit. Over fill will result in engine die or damage the carbon canister (if equipped) and void your warranty.

⚠ CAUTION

To minimize gum deposits in your fuel system and to insure easy starting, do not use gasoline left over from the previous season.

⚠ CAUTION

Allow the generating set to cool for at least two minutes before removing fuel cap when adding fuel.

Loosen the fuel cap slowly to relieve any pressure in the tank.

5 Internal battery grounding (Applicable types)

Remove the appearance cover plate. Use the nut of M6 to connect the battery grounding wire with cylinder head cover to make the ground connection of internal battery.

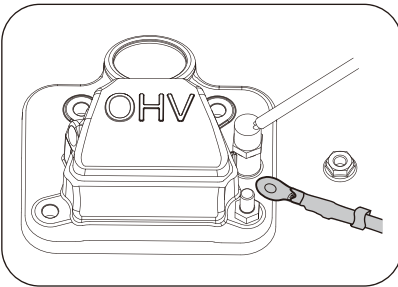

6 Electrical devices

Disconnect all electrical devices from the generating set and switch off the AC circuit breaker before start the engine.

The generating set may be hard to start with electrical devices connected.

The power of connected electrical devices cannot exceed

the generating set max power, specific power see parameter sheet for reference.

7 Generating set grounding

The generating set must be properly connected to an appropriate ground. It helps prevent electrical shock if a ground fault condition exists in the generating set or in connected electrical devices, especially when the unit is equipped with a wheel kit.

Proper grounding also helps dissipate static electricity, which often builds up in ungrounded devices.



⚠ DANGER

Electrical Shock

Failure to properly ground the generating set can result in electric shock.

A ground terminal has been provided on the generating set. For remote grounding, connect a length of heavy gauge (4 mm²) copper wire between the generator ground terminal and a copper rod driven into the ground.

Local electrical codes may also require proper grounding of the unit. We strongly recommend that you consult with a qualified electrician for grounding requirements in your area.

2. Starting the generating set

1

Perform operating checklist and remove all loads.

2 (If applicable)

Turn the ventilation knob to “ON” position when engine is running to make sure the fuel flowing.

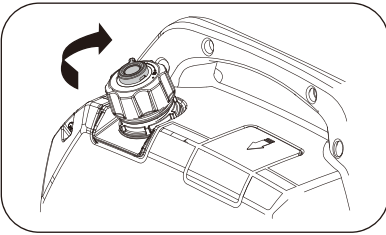

3

Turn the two-in-one switch to the “RUN” position.

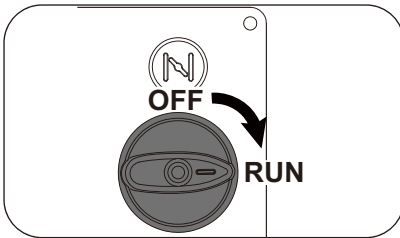

4

Turn the energy saving switch to the “ON” position. (Note: Please set the energy-saving switch to “OFF” position when it needs large starting current.)

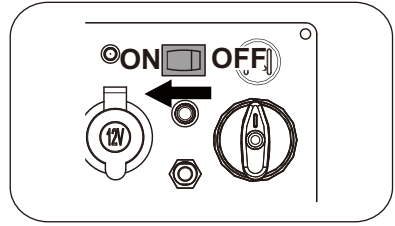

5

(Suitable for recoil starting)
Pull out the choke lever to close the choke valve.

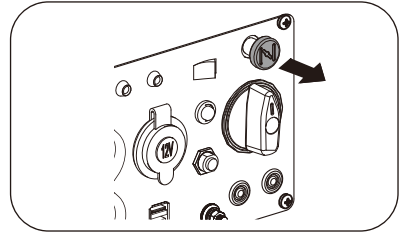

⚠ CAUTION

Choke position for starting may vary depending upon temperature and other factors. If re-starting a warm engine, there's no need to pull out the choke lever.

6

Manual start

Recoil starting:

⚠ CAUTION

Check starter cord conditions before operating. Have it replaced immediately by local authorized dealer if cord is frayed.

When starting engine, grasp the recoil starter handle and pull slowly until resistance is felt. Then pull rapidly to start the engine. When pulling the recoil starter, firmly grasp the carrying handle to avoid tumble of generating set.

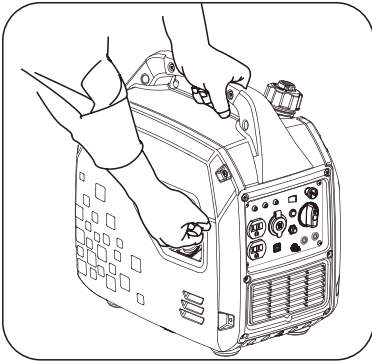

⚠ WARNING

KICKBACK

Rapid retraction of the starter cord will pull hand and arm towards the engine faster than you can let go.

Unintentional startup can result in entanglement, traumatic amputation or laceration, broken bones, fractures, bruises or sprains.

⚠ WARNING

The engine starts time cannot exceed 15 minutes. If the engine fails to start, allow the starting motor to cool for one minute before restart. Failure to operate according to this rule will damage the starting motor.

⚠ CAUTION

If the engine fails to start after attempt for 3 times or flames out after starting, inspect and ensure that the generating set is placed in horizontal surface and enough engine oil is injected.

If engine is equipped with an engine oil alarm, it is possible to prevent engine start when the engine oil in the crankcase is lower than the minimum level.

During running-in, routinely inspect the engine oil. See maintenance section for recommended maintenance period.

After the engine starts successfully, and the temperature has been increased, push the choke lever to open the choke valve. If the engine runs unstably (shaking exists), push the choke lever to the **HALF** open position. Then push it to the **FULL** open position after engine runs stably.

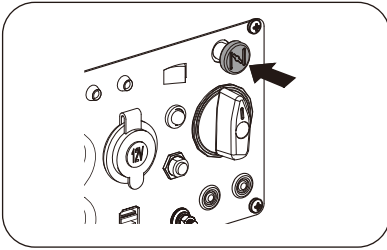

⚠ CAUTION

If the engine is in warm state, open the choke lever when restart the engine.

7

After all above operations, the engine can be normally loaded.

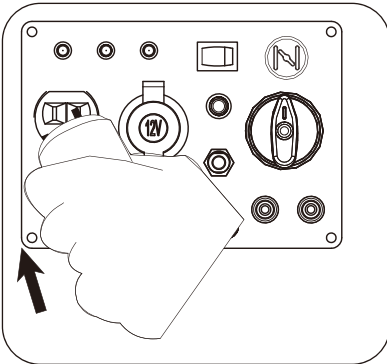

⚠ WARNING

It is prohibited to start or close the generating set when the output terminal of generating set is connected to an electric device and the electric device is in “ON” state.

3. Connect to electrical devices

Note:

1. Inspect power cord for damage before using. There is a hazard of electrical shock from crushing, cutting or heat damage.
2. Make sure that the generating set has been properly grounded. If the electric devices require grounding, the generating set must ground.
3. Allow the engine to stabilize and warm up for a few minutes after starting.
4. Make sure that the electric devices are in “**OFF**” position.
5. Connect and start the electric devices.
6. Turn off all electric devices and disconnect them from the generating set.
7. If the generating set supplies for several loads or electric devices, start the smallest one first and the largest one last.

 **DANGER**

If connected devices overheat, turn them off and disconnect them from generating set.



 **DANGER**

ELECTRICAL SHOCK

To reduce the risk of electrical shock, **DO NOT** use electrical cords that are worn, frayed, bare or otherwise damaged.

DO NOT touch bare wires or receptacles.

DO NOT handle generator or electrical cords while standing in water, or barefoot, or while hands or feet are wet.

Loading capacity

WARNING

DO NOT overload the generating set.

Exceeding the generating set's capacity can damage the generating set and/or electric devices connected to it.

You must make sure your generating set can supply enough rated (running) and (starting) watts for the electrical devices at the same time. Follow these simple steps to calculate the running and starting watts necessary for your purposes.

- Count the electrical devices you will power at the same time.
- The amount of power you need to run with the devices is the total rated (running) watts of these items.
- Starting power is the power needed shortly when electric devices start. Since not all devices start at the same time, starting power can be estimated by the maximum power of all devices plus the total power counted in step "b".

WARNING

It is necessary to equip with circuit protector or switch to isolate the generating set from the electric utility when the generating set is mainly used for backup. Failure to isolate the generating set from the power utility may result in injury or death to electric utility workers and damage to the generating set due to back feed of electrical energy.

Wattage Reference Chart

Electric equipment		Rate power(W)	Starting power(W)
Appliances	Tablet computer ^{27"}	80	100
	Energy saving lamp	5-50	5-50
	Electric cooker	1000	1000
	Computer	250	250
	Electric fan	50	100
	Washing machine	250	500
	Refrigerator	50	300
	Air-conditioner	1600	3200
Electric tooling	Electric hammer	1000	1500
	Impact Hammer	3000	6000
	Water pump	2200	5000
	Electric welding machine	5000	7500
	Air compressor	5000	10000

4. Stopping the generating set

1

Remove the connectors of all electric equipment from the generating set panel.

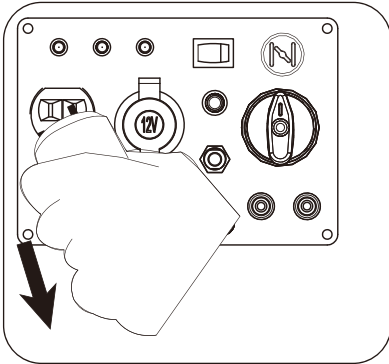

⚠ WARNING

NEVER stop the engine with electrical devices connected and running.

2

(Suitable for Wireless remote control)

Press the STOP key repeatedly for 2-3 seconds to stop the generator from running.

NOTE: Replace battery when the control distance is inadequate, and/or when the indicator light on remote control is not functioning. See maintenance section for more info.

Note: If the generator will not be in services for over 2 weeks, please turn the knob to “OFF” position, or the battery will be out of power and the generator can not be started.

3

Turn the energy saving switch to the “ON” position.

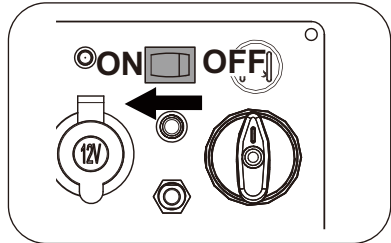

4

Allow the generating set run at no load for a few minutes to stabilize internal temperatures of the engine and generating set.

5

Turn the two-in-one switch to “OFF” position.

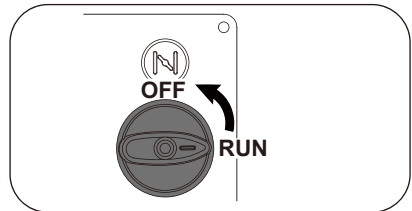

5. Parallel operation

(If applicable)

Make sure that the generating set is in a good running state before connecting it to other generating sets. The total power of electric devices should not exceed rated power of generating set.

When electric motor starts, the overload indicator (red) will light up and normally it will stop within 4 seconds. If it cannot stop, please consult your local dealer.

During parallel operation, energy-saving switches of generating sets should be in the same position.

1

Connect one generating set to other generating set(s) in parallel. Use the parallel kit to make the parallel connection (the parallel kit needs to be purchased separately).

2

Start the engine in proper order and make sure that the running indicator (green) is normal.

3

Connect the plug of electric devices to the AC receptacle of parallel kit.

4

Run the electric devices.

CAUTION

When overload too much, overload indicator (red) blinks continuously, and the generating set may be damaged. When overload a little, overload indicator (red) lights up continuously, it may shorten the service life of generating set.

When continuously operating the generating set, power cannot exceed the rated power of generating set.

The total power of electric devices cannot exceed the rated power of generating set. The manufacturers of electric devices or tools always list the rated power of similar models or serial number.

IV. Maintenance

It is the operator's responsibility to complete all scheduled maintenance in a timely manner. Correct any issue before operating the generating set. Always follow the inspection and maintenance recommendations and schedules in this manual.

WARNING

Improper maintenance or failure to correct a problem before operation can cause a malfunction and result in property damage, serious injury or DEATH.

Improper maintenance will void your warranty.



DANGER

Accidental starts can cause Severe injury or death. Remove the spark plug cap and ground generating set before performing any service.

CAUTION

The filter element may contains PAHs, PAHs are harmful for your health. Please wear gloves for protection during air filter maintenance.

1. Maintenance schedule

Stop the generating set before serving, disconnect all electric devices and battery (if equipped), and cool down the generating set completely.

Serve the generating set in a clean, dry and flat area, so that no accident would happen during the serving.

Follow the service intervals indicated in the chart below. Service your generating set more frequently when operating in adverse conditions.

Contact your local authorized service dealer for your generating set or engine maintenance needs.

		Each time before use	The first month or 10 hours <small>note2</small>	Every three months or 50 hours <small>note2</small>	Every six months or 100 hours <small>note2</small>	Every year or 300 hours <small>note2</small>
Engine oil	Inspection	√				
	Replacement		√		√	
Air filter	Inspection	√				
	Cleaning			√ <small>note3</small>		
Spark plug	Inspection and adjustment				√	
	Replacement					√
Spark Extinguisher <small>note1</small>	Cleaning				√	
Idle speed	Inspection and adjustment					√ <small>note4</small>
Valve clearance	Inspection and adjustment					√ <small>note4</small>
Carbon canister <small>note1</small>	Inspection	Every two years <small>note4</small>				
Low permeability oil tube <small>note1</small>	Inspection	Every two years <small>note4</small>				
Oil tube	Inspection	Every two years <small>note4</small>				

NOTE :

Note1: Applicable types (if available).

Note2: Before each season and after then (whichever comes first).

Note3: Service more frequently under severe, dusty, dirty conditions.

Note4: To be performed by knowledgeable, experienced owners or the authorized dealer.

2. Generating set maintenance

Use a damp cloth to clean exterior surfaces of the generating set. Use a soft brush to clean the dirt and oil.

Use an compressed air (25 PSI) to clear dirt and debris from the generating set.

Inspect all air vents and cooling slots to ensure that they are clean and unobstructed.

⚠ WARNING

DO NOT use water to clean the generating set. Water can enter the generating set through the cooling slots and damage the generating set windings.

⚠ WARNING

DO NOT modify the generating set in any way. DO NOT tamper with the governor. Generating set supplies correct rated frequency and voltage when running at factory set. Tampering with the factory set governor will void your warranty.

3. Engine maintenance

Engine oil

Only use four-stroke engine oil of SJ, SL or equivalent level which are in accordance with or higher than API standard.

Check the API label on oil bottle or other container, and make sure the “SJ, SL” or equivalent level letter is in the label.

SAE 10W-30 is recommended for general, all-temperature use. Other viscosities shown in the chart may be used when the average temperature in your area is within the indicated range.

Recommended Engine Oil Type

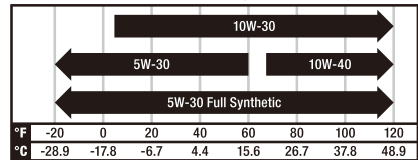

Ambient temperature

Oil capacity (rated):

See parameters

Add oil

- Place the engine on a level Surface.
- Remove the dipstick and wipe it clean.

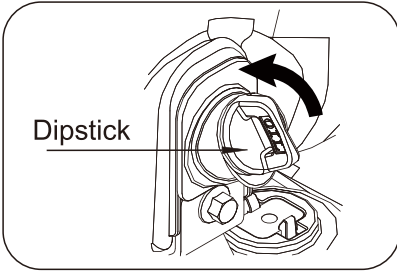

c. Add recommended oil to the upper limit.

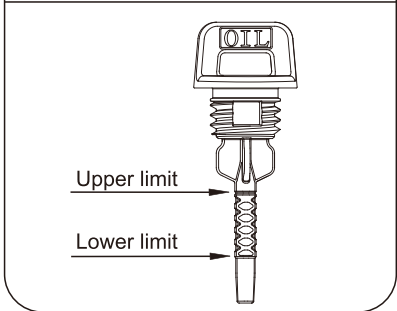
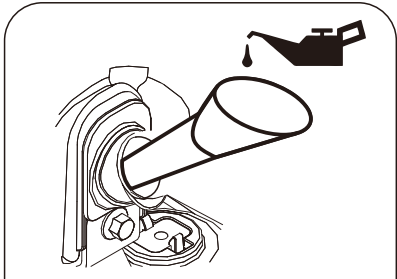

d. Fully tighten the dipstick.

e. Dispose of used oil at an approved waste management facility.

⚠ CAUTION

Oil level check

Reinstall dipstick into hole; rest on oil fill neck. **DO NOT** thread cap into hole.

e. Properly dispose of any used oil at an approved waste management facility.

Change oil

⚠ CAUTION

Change oil when the engine is warm from operation. The oil temperature can reach up to 140°C in the warm state, and careful operation should be taken when changing the oil to prevent burns.

a. Place the machine on a level surface which is 300mm higher than the ground.

b. Remove the oil maintenance cover.

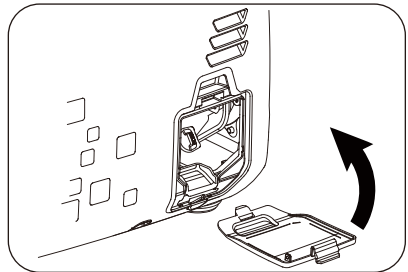

c. Place the waste oil box on the ground.

d. Remove the oil dipstick, and tilt the machine to pour the oil.

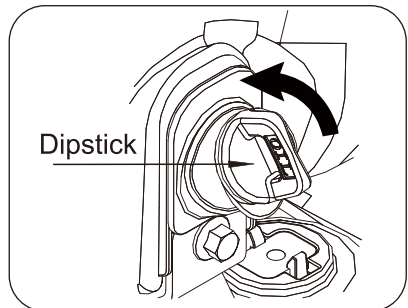

e. Add recommended oil to the upper limit.

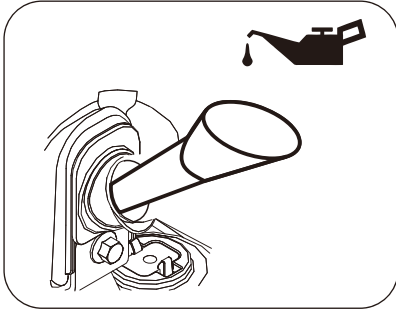

- f. Fully tighten the dipstick.
- g. Properly dispose of any used oil at an approved waste management facility.
- h. Reinstall the oil maintenance cover.

⚠ WARNING

The engine is not filled with oil at the factory. Any operation before it has been properly filled with the recommended type and amount of oil may result in engine damage and void your warranty.

Air filter

- a. Remove the appearance cover.
- b. Loosen the filter fix clamp and remove the cover of the air filter.
- c. Remove the foam filter element.
- d. Wash in liquid detergent and warm water.
- e. Squeeze thoroughly dry in a clean cloth.

- f. Saturate in clean engine oil.
- g. Squeeze in a clean absorbent cloth to remove all excess oil.
- h. Assemble the filter element onto the filter unit
- i. Assemble the filter fix clamp.
- j. Reinstall the appearance cover.

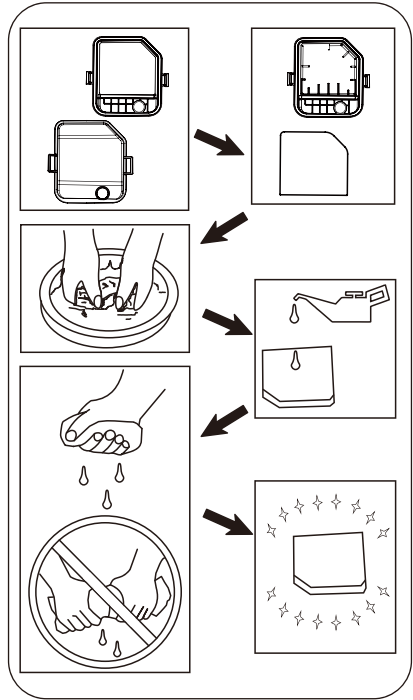

⚠ WARNING

DO NOT run the engine without the air filter, or serious danger can result.

Spark plug

- Clean any dirt from the spark plug cap and spark plug base.
- Remove the spark plug cap.
- Using socket wrench to loose and remove the spark plug.
- Inspect the spark plug and spark plug washer, if it was broken or worn, replace with a new one. Clean the spark plug with wire brush if reuse it.
- Check spark plug gap. Carefully bend side electrode to adjust the gap if necessary.

Spark plug gap:

0.6mm-0.8mm

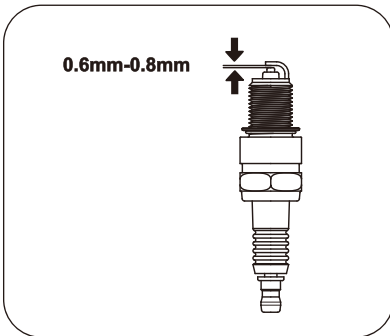

- Carefully thread the plug into the engine **by hand**.
- After the spark plug is seated, use spark plug wrench to tighten the plug.

Spark Plug Tighten Torque:

15-20 N.m

- Attach the spark cap to the plug and connect the spark plug wire to the plug.

⚠ WARNING

Only use recommended spark plug or equivalent. **DO NOT** use spark plugs that have improper heat range.

Spark Arrester

(Applicable types)

- Allow the generating set to cool completely before servicing the spark arrester.
- Remove the muffler blind window first.
- Remove the spark arrester screen.
- Carefully remove the carbon deposits from the spark arrester screen with a wire brush.
- Replace the spark arrester if it is damaged.
- Reinstall the spark arrester in the muffler and reinstall the muffler blind window.

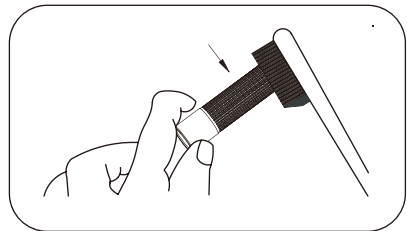

Clean carbon deposit



V. Trouble-shooting

Failure	Trouble	Solution
Generating set fails to start	Two-in-one switch is in “OFF” position.	Turn two-in-one switch to the “RUN” position.
	Lack of fuel.	Fill fuel tank per instructions in this manual.
	Lack of engine oil.	Check oil level. This engine is equipped with a low oil sensor. The engine cannot be started unless the oil level is above the prescribed lower limit.
	No ignition.	Remove the spark plug cap. Clean any dirt around the plug base, and then remove the spark plug. Install the spark plug in the plug cap. Turn the two-in-one switch to “RUN” position. Grounding the electrode to any engine ground, pull the recoil starter to see if sparks jump across the gap. If there is no spark, replace the plug. Reinstall the plug and start engine according to instructions in this manual. Consult Customer Service if necessary.
	Spark plug is splashed by fuel	Remove the spark plug and wipe the fuel.
Generating set has no output	The generating set flames out after running for a certain time.	Turn the ventilation knob on the fuel tank cap to “ON” position; Check the fuel and oil level. Add them if necessary.
	Breaker trip	Reset circuit breakers.
Generating set has no output	Inadequate cord sets or extension cords.	Check cord sets or extension cords capabilities in section controls; cable size in this manual. Consult Customer Service if necessary.

VI. Storage and transportation

Storage

The generating set should be started at least once every 2 weeks and allowed to run for at least 20 minutes. Follow the instructions below for longer term storage if the generating set will be out of service for 2 months or more.



Fire or explosion

Gasoline is highly flammable and extremely explosive.

Empty the fuel tank and shut off fuel valve before storing or transporting this generating set.

slightly to distribute the oil and lubricate the cylinder. And then attach the spark plug.

7. Store the unit in a clean, dry area out of direct sunlight.

1. Allow the generating set to cool completely before storage.
2. Clean the generating set according to instructions in Maintenance section.
3. Drain all fuel completely from the fuel tank, fuel hose and carburetor to prevent gum from forming.
4. Close the fuel switch to cut down fuel supply.
5. Remove the appearance cover plate. Unscrew the oil dipstick and slightly tilt the whole set to pour out the oil.
6. Remove the spark plug and pour about 15 ml of oil into the cylinder. Pull the recoil starter

Transportation

To prevent fuel spillage when transporting or during temporary storage, the generating set should be secured upright in its normal operating position, with the engine switch OFF. The two-in-one switch should be turned OFF.

WARNING

When transporting:

Do not overfill the tank. Do not operate the generating set while it is on vehicle. Take the generating set off the vehicle and use it in a well-ventilated place. Avoid a place exposed to direct sunlight when putting the generating set on a vehicle. If the generating set is left in an enclosed vehicle for many hours, high temperature inside the vehicle could cause fuel to vaporize resulting in a possible explosion. Do not drive on a rough road for an extended period with the generating set on board. If you must transport the generating set on a rough road, drain the fuel from the generating set beforehand.

VII. Specification

1. Specification parameter table

Feature		Model	RVMP-220472
Engine parameter	Engine model		148FD/P-D
	Style		OHV
	Displacement (cm ³)		79
	Ignition system		CDI
	Start style		Recoil starting
	Oil capacity(L)		0.5
Series parameter	Frequency(Hz)		60
	Voltage(V)		120
	Rated power(kW)		1.9
	Maximum power(kW)		2.0
	Power factor		1
	Insulation rate		F
	Fuel capacity(L)		4
	Operating temperature(°C)		-15~40
	Max. site altitude of installation(m)		1500
	Measured sound pressure level(dB(A))		≤72
	Measurement uncertainty(dB(A))		≤1.5
	Guaranteed sound power level(dB(A))		≤93
	Net weight(kg)		18.3

Note: The generating set with different specification and configurations may have different parameters and may change at any time without notice.

2. Wiring diagram

Recoil starting

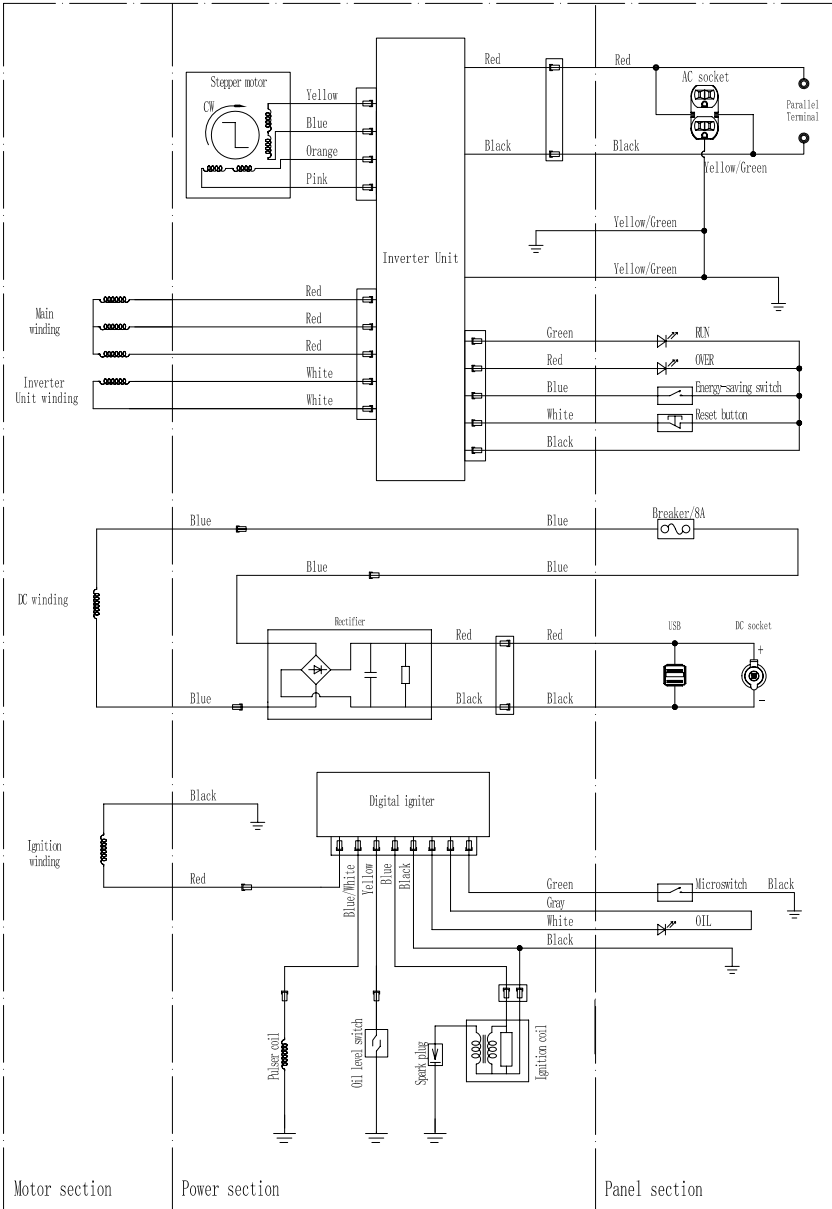

NOTE: Because of the difference of generator, the wiring diagram is only for reference.



FEDERAL and CALIFORNIA EXHAUST AND EVAPORATIVE EMISSIONS CONTROL WARRANTY STATEMENT YOUR WARRANTY RIGHTS AND OBLIGATIONS

The United States Environmental Protection Agency (EPA), the California Air Resources Board, and RV Mobile Power, LLC. (RVMP) are pleased to explain the exhaust and evaporative emissions ("emissions") control system's warranty on your 2023 small off-road engine or equipment (SORE). In California, new equipment that use small off-road engines must be designed, built, and equipped to meet the State's stringent anti-smog standards. RVMP must warrant the emissions control system on your SORE for the periods of time listed below provided there has been no abuse, neglect or improper maintenance of your small off-road engine or equipment leading to the failure of the emissions control system.

Your emissions control system may include parts such as the carburetor or fuel-injection system, the ignition system, catalytic converter, fuel tanks, fuel lines (for liquid fuel and fuel vapors), fuel caps, valves, canisters, filters, clamps and other associated components. Also included may be hoses, belts, connectors, and other emission-related assemblies.

Where a warrantable condition exists, RVMP will repair your SORE at no cost to you including diagnosis, parts and labor.

MANUFACTURER'S WARRANTY COVERAGE:

This exhaust and evaporative emissions control system on your SORE is warranted for two years. If any emissions-related part on your SORE is defective, the part will be repaired or replaced by RVMP.

OWNER'S WARRANTY RESPONSIBILITIES:

As the SORE owner, you are responsible for performance of the required maintenance listed in your owner's manual. RVMP recommends that you retain all receipts covering maintenance on your SORE, but RVMP cannot deny warranty coverage solely for the lack of receipts or for your failure to ensure the performance of all scheduled maintenance.

As the SORE owner, you should however be aware that RVMP may deny your warranty coverage if your SORE or a part has failed due to abuse, neglect, or improper maintenance or unapproved modifications.

You are responsible for presenting your SORE to a RVMP distribution center or service center as soon as the problem exists. The warranty repairs shall be completed in a reasonable amount of time, not to exceed 30 days.

If you have any questions regarding your warranty rights and responsibilities, you should contact RV Mobile Power, LLC. at 1-855-427-7978 or email to support@rvmp.co or <http://www.rvmp.co>.

DEFECTS WARRANTY REQUIREMENTS:

(a) Applicability. This section applies to emissions control systems on small off-road engines or equipment that use small off-road engines subject to the emission standards in this Article. The warranty period begins on the date the engine or equipment is delivered to an ultimate purchaser.

(b) General Emissions Warranty Coverage. The engine or equipment must be warranted to the ultimate purchaser and any subsequent owner that the emissions control system when installed was:

- (1) Designed, built, and equipped so as to conform with all applicable regulations; and
- (2) Free from defects in materials and workmanship that causes the failure of a warranted part for a period of two years.

(c) The warranty on emissions-related parts will be interpreted as follows:

(1) Any warranted part that is not scheduled for replacement as required maintenance in the written instructions furnished with each new engine or equipment must be warranted for the warranty period defined in subsection

(b)(2). If any such part fails during the period of warranty coverage, it must be repaired or replaced by RVMP according to subsection (4) below. Any such part repaired or replaced under the warranty must be warranted for a time not less than the remaining warranty period.

(2) Any warranted part that is scheduled only for regular inspection in the written instructions furnished with each new engine or equipment must be warranted for the warranty period defined in subsection (b)(2). A statement in such written instructions to the effect of "repair or replace as necessary" shall advise owners of the warranty coverage for emissions related parts. Replacement within the warranty period is covered by the warranty and will not reduce the period of warranty coverage. Any such part repaired or replaced under warranty must be warranted for a time not less than the remaining warranty period.

(3) Any warranted part that is scheduled for replacement as required maintenance in the written instructions furnished with each new engine or equipment must be warranted for the period of time prior to the first scheduled replacement point for that part. If the part fails prior to the first scheduled replacement, the part must be repaired or replaced by the manufacturer according to subsection (4) below. Any such part repaired or replaced under warranty must be warranted for a time not less than the remainder of the period prior to the first scheduled replacement point for the part.

(4) Repair or replacement of any warranted part under the warranty provisions of this article must be performed at no charge to the owner at a warranty station.

(5) Notwithstanding the provisions of subsection (4) above, warranty services or repairs must be provided at distribution centers that are franchised to service the subject engines or equipment.

(6) The owner must not be charged for diagnostic labor that leads to the determination that a warranted part is in fact defective, provided that such diagnostic work is performed at a warranty station.

(7) Throughout the emissions control system's warranty period set out in subsection (b)(2), RVMP must maintain a supply of warranted parts sufficient to meet the expected demand for such parts and must obtain additional parts if that supply is exhausted.

(8) Manufacturer-approved replacement parts that do not increase the exhaust or evaporative emissions of the engine or evaporative emission system must be used in the performance of any warranty maintenance or repairs and must be provided without charge to the owner. Such use will not reduce the warranty obligations of RVMP.

(9) The use of add-on or modified parts may be grounds for disallowing a warranty claim made in accordance with this Article. RVMP will not be liable under this Article to warrant failures of warranted parts caused by the use of an add-on or modified part.

(10) RVMP shall provide any documents that describe RVMP's warranty procedures or policies within five working days of request by the Executive Officer.

(d) A list of all emissions warranty parts must be included with each new engine or equipment subject to this Article. The emissions warranty parts list shall include all parts whose failure would increase exhaust or evaporative emissions, and contains the following parts (if applicable):

(1) Fuel Metering System

- Carburetor and internal parts (and/or pressure regulator or fuel injection system).
- Air/fuel ratio feedback and control system.
- Cold start enrichment system.

(2) Air Induction System

- Controlled hot air intake system.
- Intake manifold.
- Air filter.

(3) Ignition System

- Spark Plugs.
- Magneto or electronic ignition system.
- Spark advance/retard system.

(4) Exhaust Gas Recirculation (EGR) System

- EGR valve body, and carburetor spacer if applicable.
- EGR rate feedback and control system.

(5) Air Injection System

- Air pump or pulse valve.
- Valves affecting distribution of flow.
- Distribution manifold.

(6) Catalyst or Thermal Reactor System

- Catalytic converter.
- Thermal reactor.
- Exhaust manifold.

(7) Particulate Controls

- Traps, filters, precipitators, and any other device used to capture particulate emissions.

(8) Miscellaneous Items Used in Above Systems

- Vacuum, temperature, and time sensitive valves and switches.
- Electronic controls.
- Hoses, belts, connectors, and assemblies.

(9) Evaporative Controls

- Fuel Tank
- Fuel Cap
- Fuel Lines (for liquid fuel and fuel vapors)
- Fuel Line Fittings
- Clamps**
- Pressure Relief Valves**
- Control Valves**
- Control Solenoids**
- Electronic Controls**

- Vacuum Control Diaphragms**
- Control Cables**
- Control Linkages**
- Purge Valves
- Gaskets
- Liquid/Vapor Separator
- Carbon Canister
- Canister Mounting Brackets
- Carburetor Purge Port Connector

**Note: As they relate to the evaporative emission control system.

Note: Any other warranty statements apply to engines or equipment units shall not limit the emissions warranty period (two years) or its applicability to subsequent owners after the ultimate purchaser.

Phone: (855) HAPPYRV

Email: support@rvmp.co

Manuals: <https://rvmp.co/manuals>

Visit rvmp.co • Copyright© 2022-2023 RV Mobile Power, LLC. ~ All Rights Reserved.



RV MOBILE POWER, LLC

Phone: (855) HAPPYRV Email: support@rvmp.co

www.rvmp.co

2256#/V1.1