

RUKKET GOLF CHIPPING TARGET FOLD UP INSTRUCTIONS

Our video instructions provide the best guidance for setting up your chipping target. They can be viewed online at



Please call us if you have any questions or concerns at **1-855-4RUKKET**
Please read our product safety warnings before setup

INCLUDED EQUIPMENT

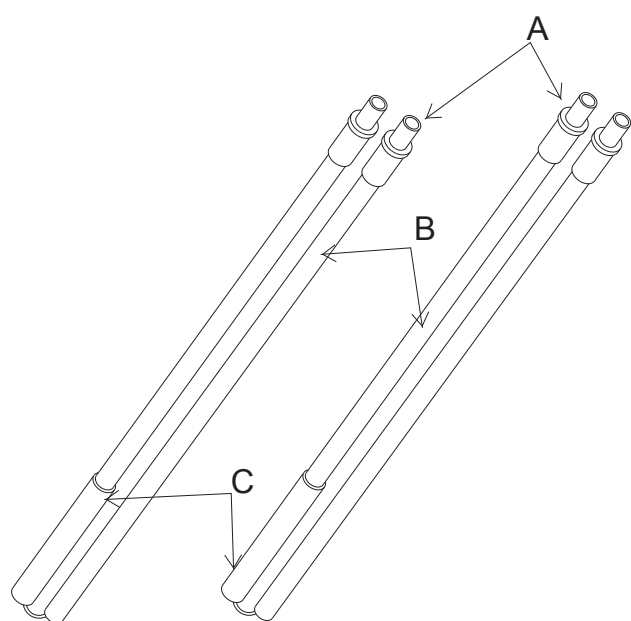

- A. Metal Cap
- B. Fiberglass Poles
- C. Metal Sleeve
- D. Net
- E. Metal Stakes
- F. Foam Golf Balls

QUESTIONS? GIVE US A CALL! (1-855)-478-5538

RUKKET®

RUKKET GOLF CHIPPING TARGET FOLD UP INSTRUCTIONS

Our video instructions provide the best guidance for setting up your chipping target. They can be viewed online at



Please call us if you have any questions or concerns at **1-855-4RUKKET**

Please read our product safety warnings before setup

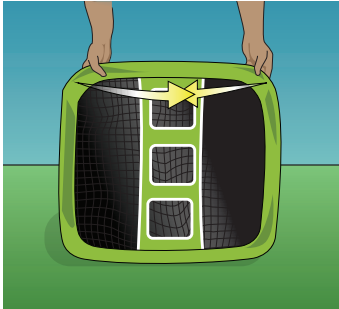

1. After removing, folding, and storing the two fiberglass poles, fold the Golf Chipper flat and grasp the two upper corners.

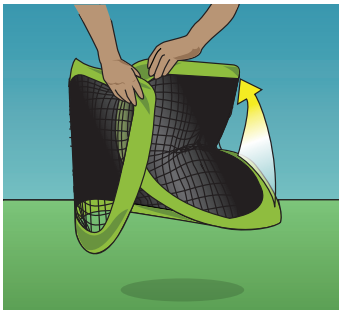

2. Fold inward with one edge going underneath the other. The net will form itself into three circles.

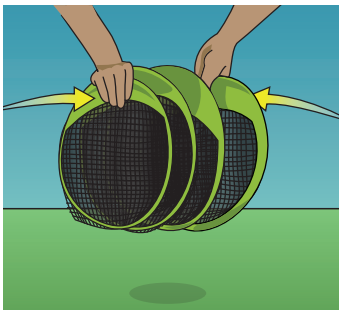

3. Hold the top circles in place and fold the bottom circle onto them before placing into the carry bag.

WARNING:

- Adult supervision is required
- Take care when opening, because the spring steel opens forcefully
- No one should be standing near this product when it is in use
- This product should be set up far away from people, vehicles, and structures
- Failure to follow these precautions could result in serious injury or damage to property.

QUESTIONS? GIVE US A CALL! (1-855)-478-5538

RUKKET®

RUKKET GOLF CHIPPING TARGET

INSTRUCCIONES PARA GUARDAR

Nuestras instrucciones en video brindan la mejor guía para configurar su objetivo de astillado. Se pueden ver en línea en

RUKKET.COM / **RukketSports**

Llámenos si tiene alguna pregunta o inquietud en **1-855-4RUKKET**
Por favor lea nuestras advertencias de seguridad del producto en la página 2 antes de la instalación.

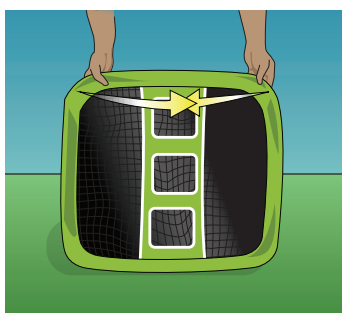

1. Después de mover, doblar y guardar las dos varillas de fibra de vidrio, pliega el blanco para chipping de manera que este plano y sujeta las dos esquinas superiores del blanco mirando hacia afuera.

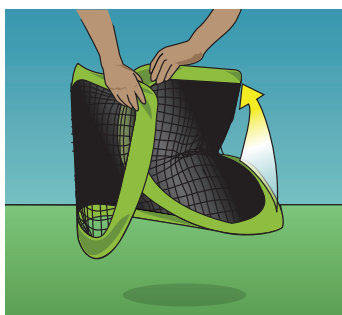

2. Dobla hacia dentro una orilla, tendrá que ir dentro de la otra. La red se plegara por sí sola, dentro de tres círculos.

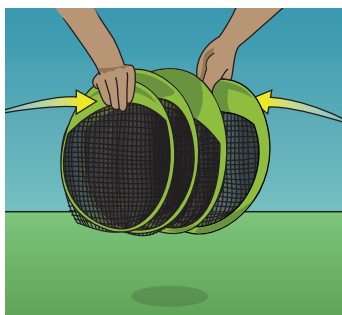

3. Sostén los círculos superiores en el lugar y dobla el círculo inferior dentro, antes de colocar dentro de la bolsa para guardar.

ADVERTENCIA:

• Se requiere la supervisión de un adulto, siempre que esté en uso • Prohibido pararse cerca de este producto cuando está en uso • Este producto debe ser armado lejos de personas, vehículos y estructuras • En caso de no seguir estas precauciones, los resultados pueden causar heridas serias o daños a la propiedad.

PREGUNTAS? ¡LLAMANOS! (1-855)-478-5538

RUKKET®