

RUKKET REBOUNDER

ASSEMBLY INSTRUCTIONS

Our video instructions provide the best guidance for setting up your Rukket Rebounder. They can be viewed online at



Please call us if you have any questions or concerns at **1-855-4RUKKET**
Please read our product safety warnings before setup

INCLUDED EQUIPMENT

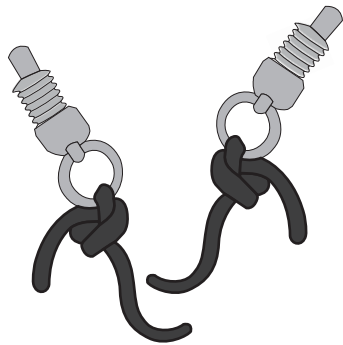

2 Plunger Bolts
connected by a
Paracord

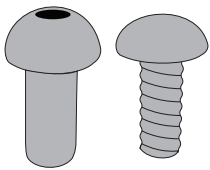

12 Bolt Pairs

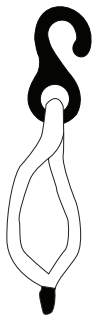

38 Bungees

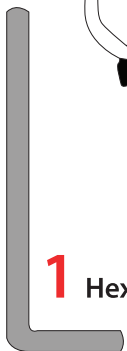

1 Hex Key

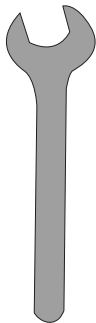

1 Wrench

HARDWARE

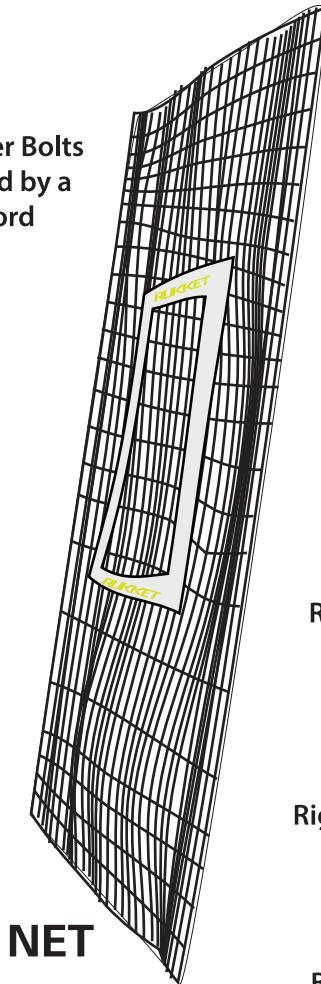

NET



NET EXPANDER

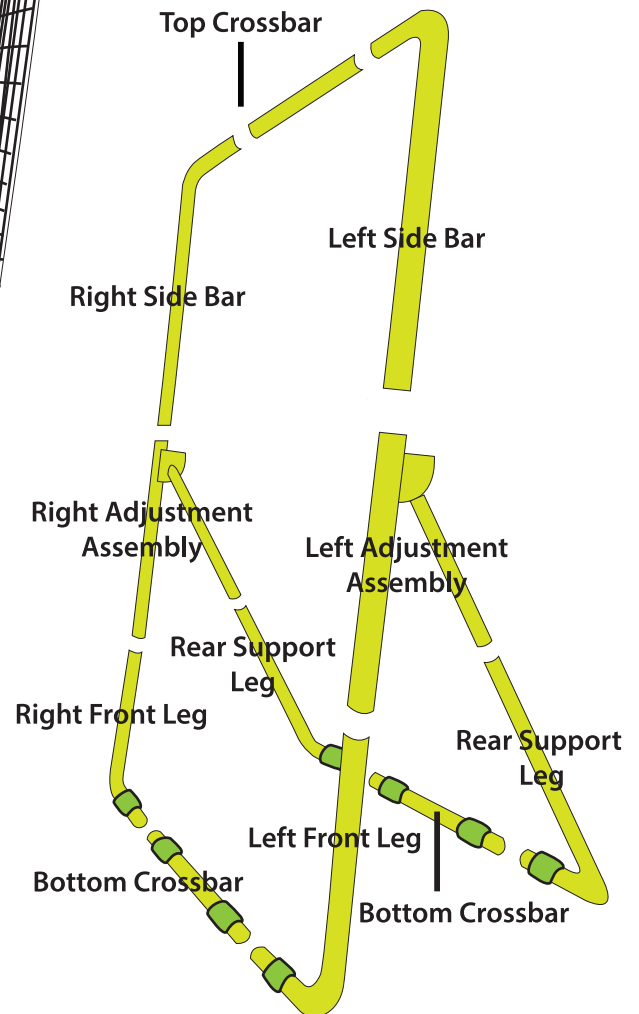

FRAME

RUKKET REBOUNDER

ASSEMBLY INSTRUCTIONS

PRODUCT SAFETY WARNING



- Keep hands and fingers clear of all moving parts.
- When adjusting the angle of the rebounder, keep positive control of the top crossbar so as not to drop it on your head or body.
- Place the rebounder on a level, well-drained surface. Make sure to set the rebounder up in a location where, when a ball misses the rebounder or is missed by the player on its return, the ball will not strike or cause damage to people, pets, houses, or structures.
- Children should not operate the rebounder adjustment; an adult should make adjustments.
- To prevent injury, children should not use the rebounder until properly instructed.

- When adjusting the angle of your rebounder, do not let go of the top crossbar until the plunger bolts are fully extended into the adjustment holes.
- It is important to become familiar with the way a ball reacts to the rebounder; stand at least 30 feet from the rebounder when first using it so you can become familiar with the speed and power of returned balls.
- Always check for loose or missing bolts and for damage to the bungees or netting before use. Loose bolts should be tightened.
- If there is a problem with the netting or any other part of the rebounder, please contact us at 1-855-4RUKKET
- Failure to heed these warnings may result in bodily injury or damage to property.

PRODUCT MAINTENANCE

- The plunger bolts should be periodically oiled to maintain proper function (oil not included).
- To prolong the life of the bungees, we suggest you store your rebounder indoors, as water and UV rays will damage the elastic material and make it less effective.

1.

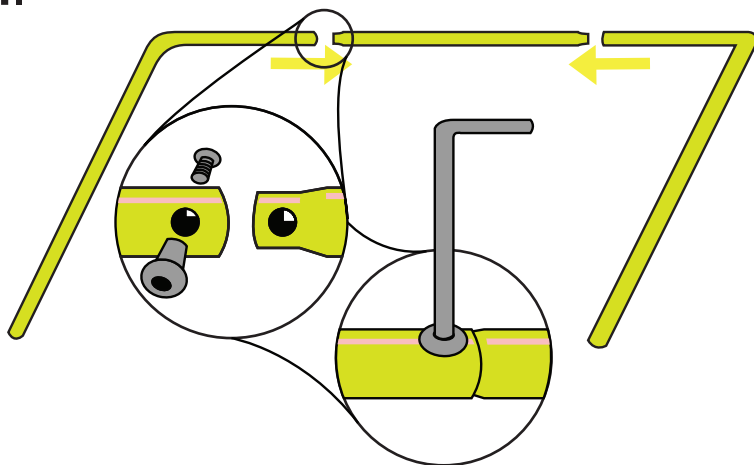

Join both top, side bars to the top crossbar. The fatter, circular receiving nut goes into the round hole and the outside-threaded bolt with the squared neck under the head goes into the square hole. Once you've threaded the bolt into the nut correctly, seat the square bolt neck into the square cut-out in order to tighten the nut with the hex key.

NOTE: The circular holes always face to the inside of the frame. The square holes are always on the outside.

NOTE: You may find it easier to join the carriage bolts together inside the bars by hand-tightening them before seating the square neck of the bolt into the bar's square cut-out and tightening with the hex key.

2.

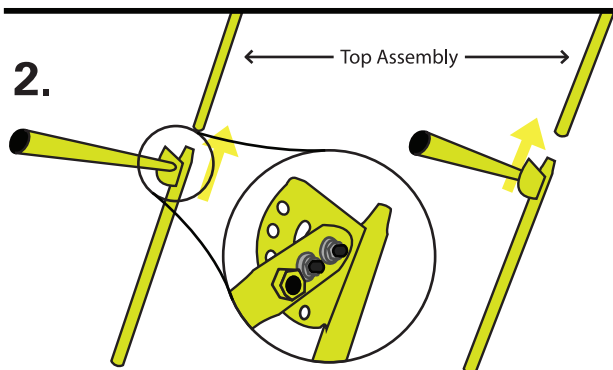

Attach the middle bars with angle-adjustment plates to the top assembly. The adjustment plates should be near the top of the rebounder and the support bar that moves along the plate should be on the inside of the rebounder.

PAGE 2

QUESTIONS? GIVE US A CALL! (1-855)-478-5538

RUKKET®

V2

RUKKET REBOUNDER

ASSEMBLY INSTRUCTIONS

3.

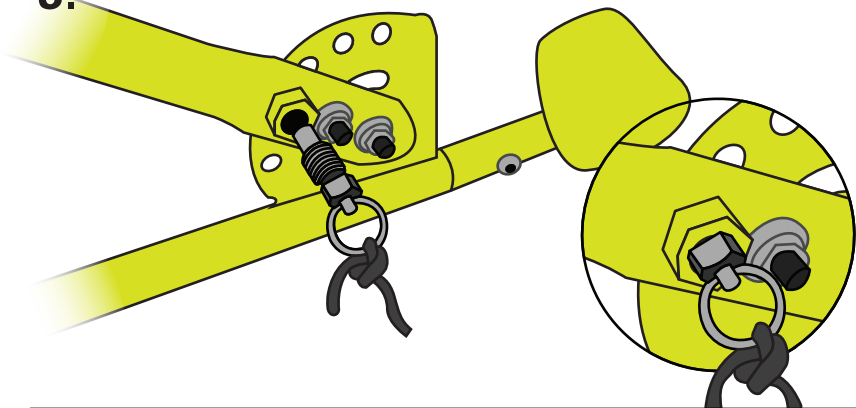

Screw the plunger bolts into the welded on nut and tighten down. Pull the cord to disengage the plunger and release it to allow the plunger to engage one of the holes. Set both of the rear support middle bars at the same setting so that they are both at the same angle.

4.

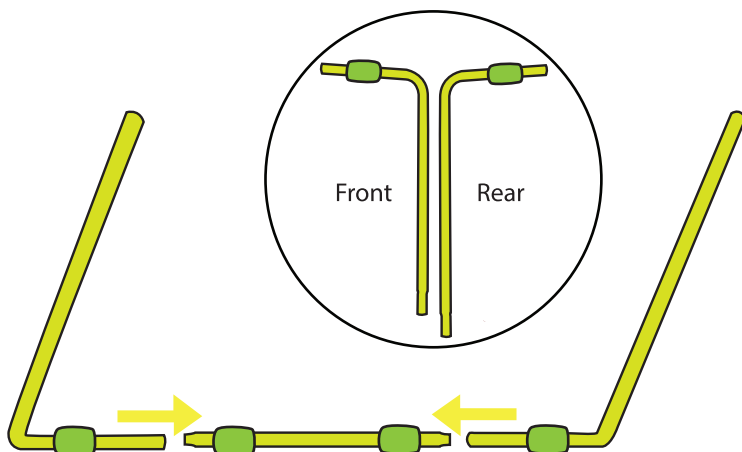

Attach the front legs with the silicone traction pads to one of the bottom crossbars (both bottom crossbars have silicone traction pads).

NOTE: The front legs are slightly shorter than the rear support legs. Place them next to each other to identify which are the front and which are the rear.

5.

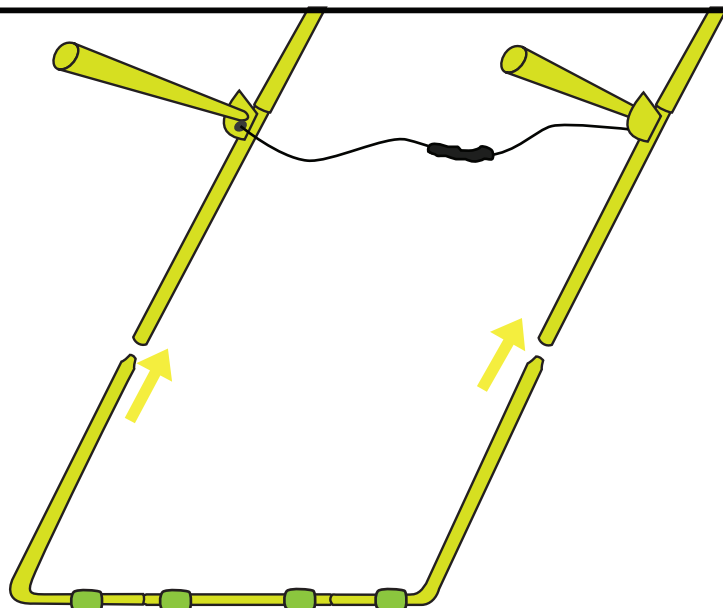

Attach the lower front assembly to the middle bars to complete the front of the rebounder.

RUKKET REBOUNDER

ASSEMBLY INSTRUCTIONS

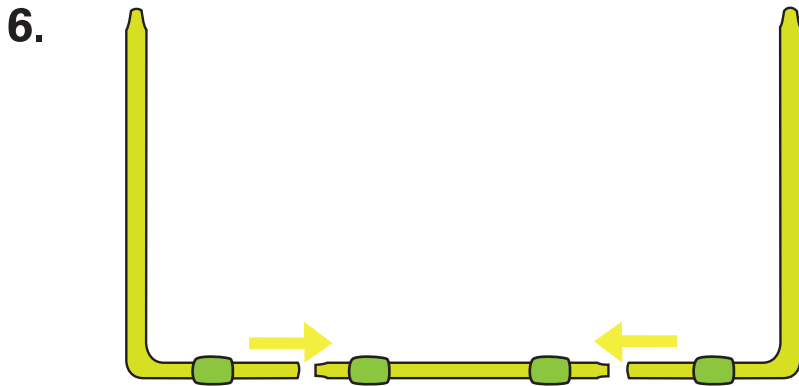

Attach the two lower legs with silicone traction pads to the remaining bottom crossbar to make the rear support assembly.

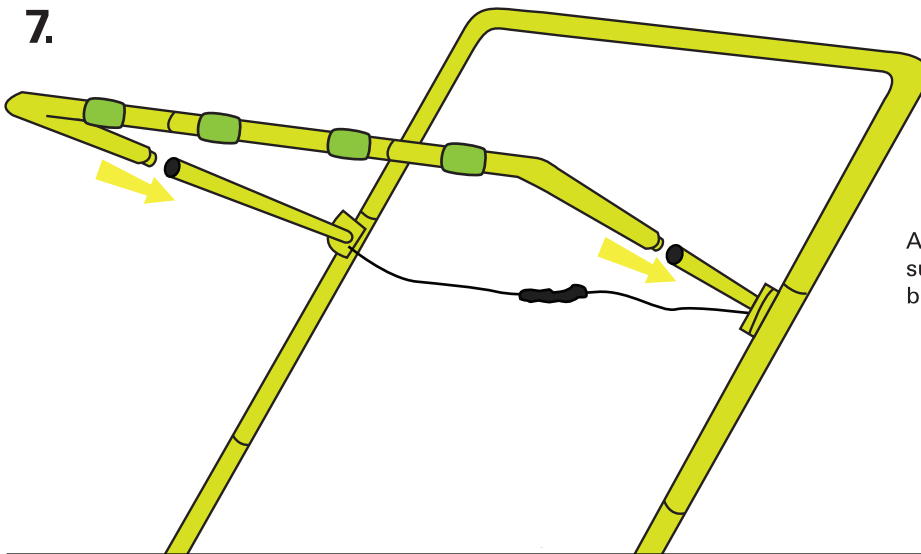

Attach the rear support assembly to the rear support middle bars. When the frame is securely bolted together, stand it up.

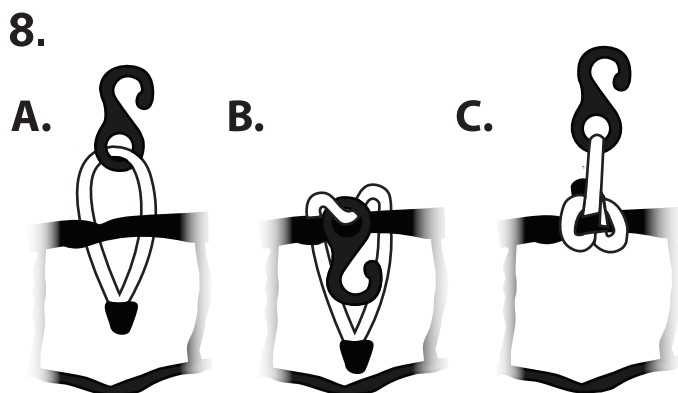

Attach the bungees to the thick woven edge of the netting by using a girth hitch. Hitch 2 bungees in each of the 4 corners of the netting. These 8 bungees will stretch the netting up-and-down and side-to-side. The bungees should not cross each other.

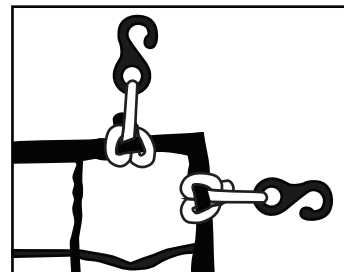

RUKKET REBOUNDER

ASSEMBLY INSTRUCTIONS

9.

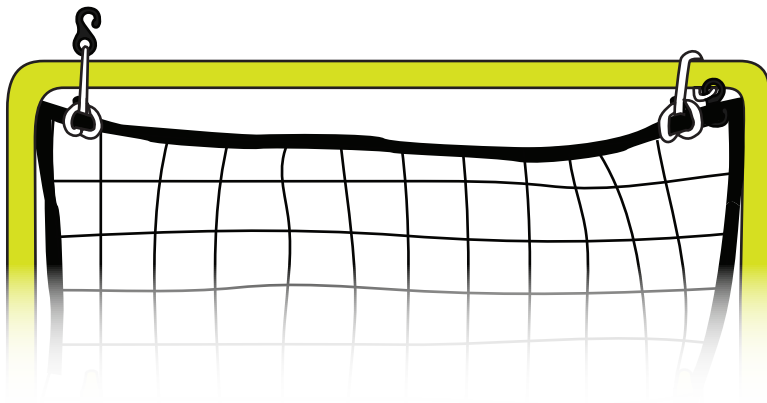

Hang the netting by passing the top crossbar bungees over the upper crossbar and hooking them back onto the thick woven edge of the netting.

10.

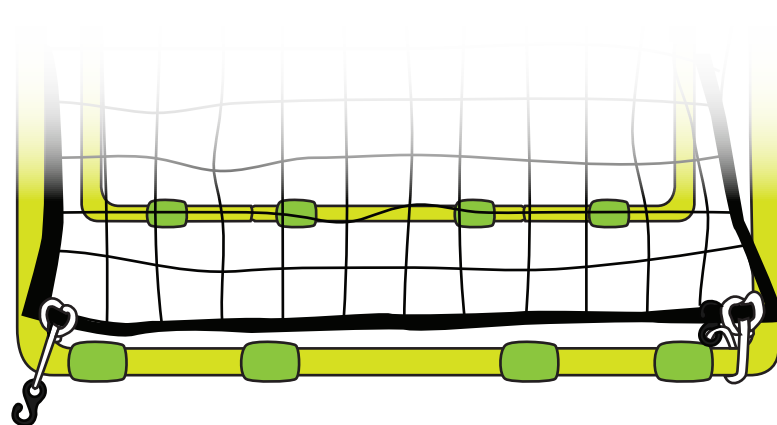

Hook the two bottom lower crossbar bungees around the lower crossbar to stretch the netting up-and-down.

11.

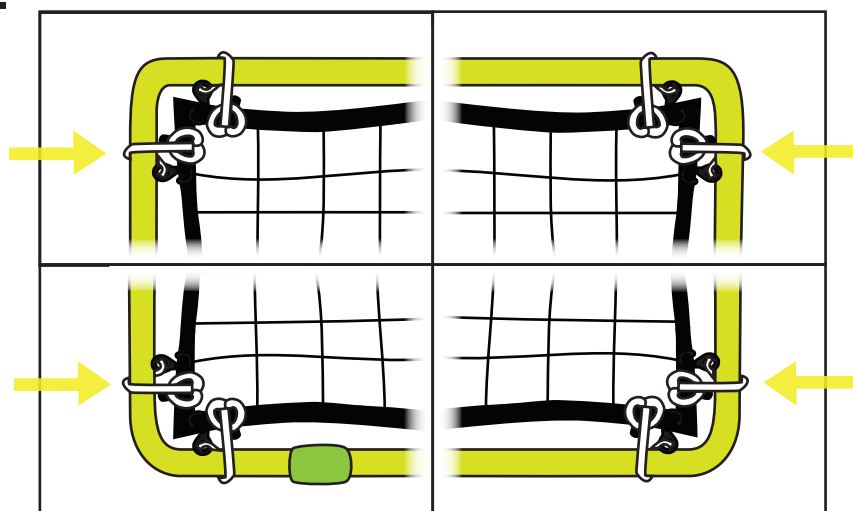

Stretch the netting side-to-side by hooking the 4 remaining corner bungees around the side bars.

RUKKET REBOUNDER

ASSEMBLY INSTRUCTIONS

12.

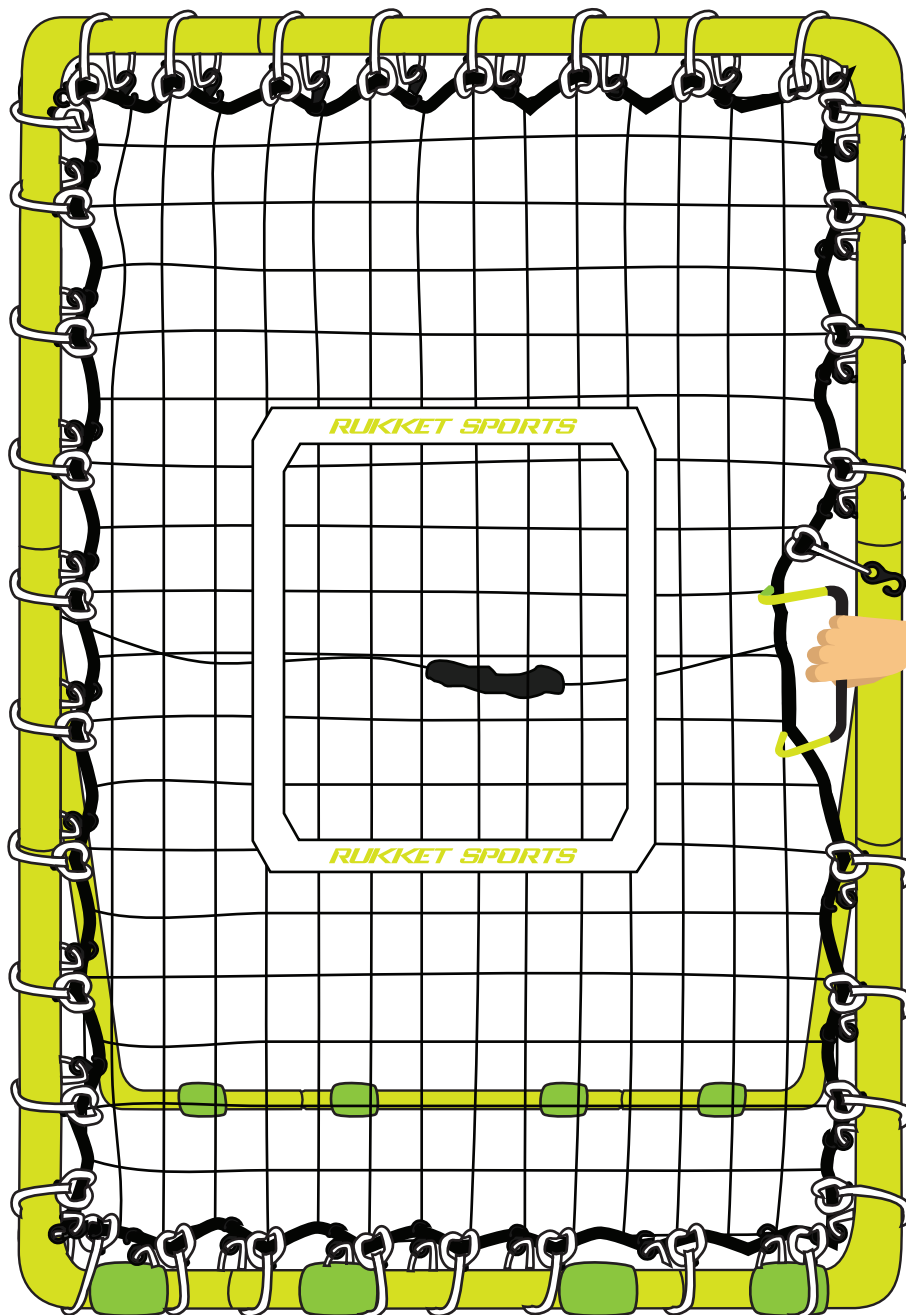

Alternate adding the remaining bungees between the top, bottom, left and right to ensure that the netting is stretched evenly. We suggest using all of the bungees, spaced 3 to 4 squares apart, to create maximum rebounding action.

Use the net expander by grabbing the thick woven edge with both hooks on the same side of the intended bungee.

Intended bungee

RUKKET REBOUNDER ADJUSTMENT INSTRUCTIONS

Please read our product safety warnings on page two before adjusting the rebounder.

