

AIR DEFENSE BACKSTOP ASSEMBLY INSTRUCTIONS

Our video instructions provide the best guidance for setting up your Air Defense Backstop. They can be viewed online at



Please call us if you have any questions or concerns at **1-855-4RUKKET**
Please read our product safety warnings before setup

PRIOR TO USE

Inspect the netting and frame for damage or wear. Make sure the frame and net are assembled correctly and on a flat surface, at least ten (10) feet away from structures and vehicles. Failure to follow these precautions could result in serious injury or damage to property.

INCLUDED EQUIPMENT

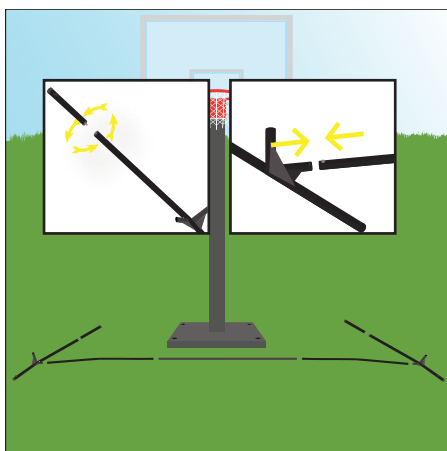
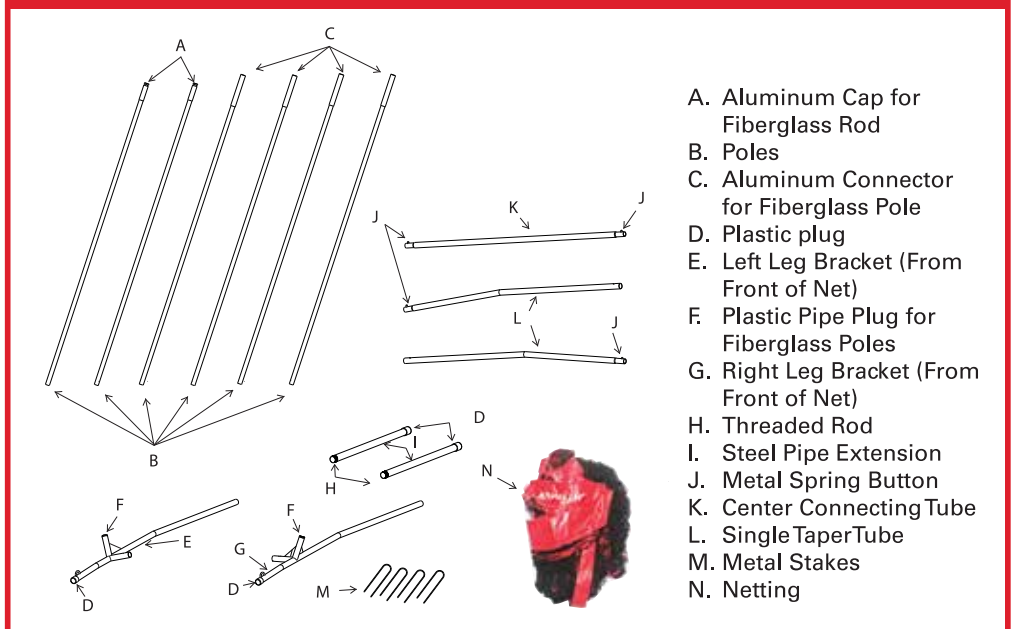

1) Screw the rear leg extenders onto the backs of the legs. Use the buttons to snap the base bars together. Then, attach the assembled base bar to the legs. Now that your base frame is assembled, position it right in front of your basketball goal.

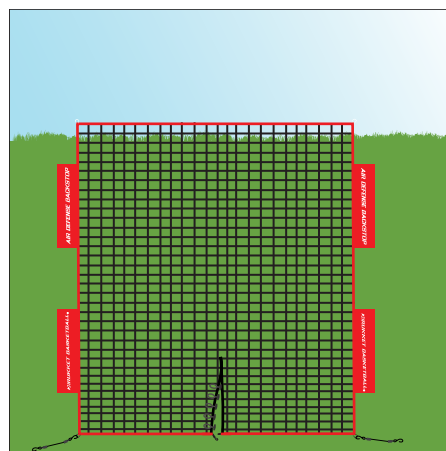

2) Lay the net out flat behind your basketball goal so that the logos are facing up.

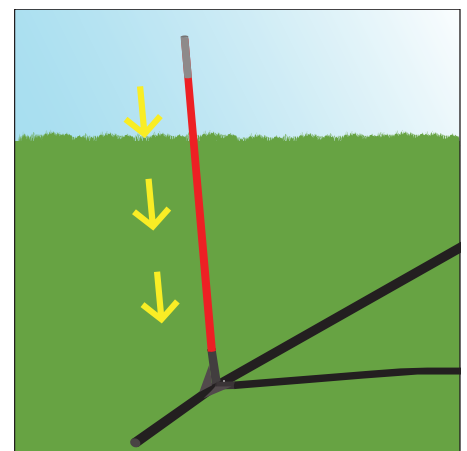

3) Insert two lower fiberglass rods (with coupling tubes on top) into the base.

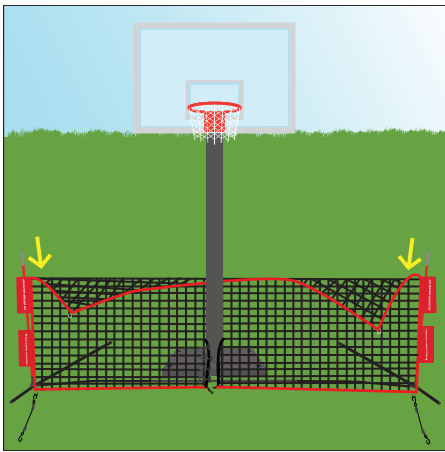

4) Thread the sleeves over the poles making sure that the black bungees and goal post opening are at the bottom.

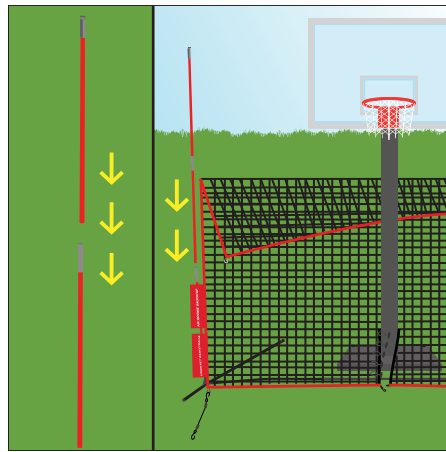

5) Insert a fiberglass pole with metal knob on top into one of the remaining fiberglass poles with metal coupling tube, and then insert that assembled piece into one of the fiberglass poles that is already attached to the base. Repeat for the other side.

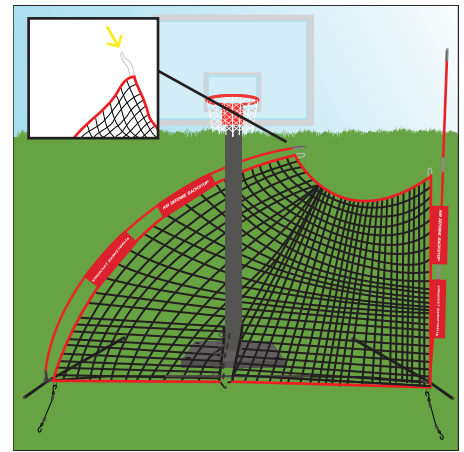

6) With one of the upper corner white loops in hand, bend that side's fiberglass pole down and inward by walking your hands, hand-over-hand style, up the pole as it is bending downward until you reach the top. Then attach the white corner loop to the metal knob and slow let the fiberglass pole return back to an upright position. Repeat for the other side.

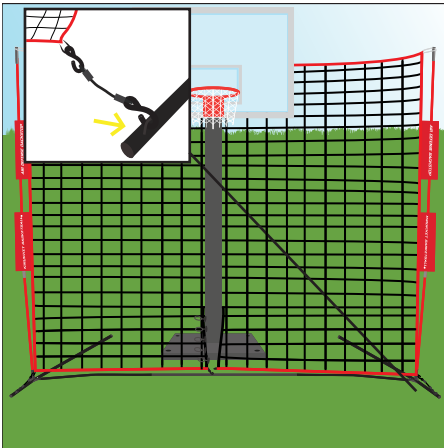

7) Hook the black bungees onto the fronts of the legs.

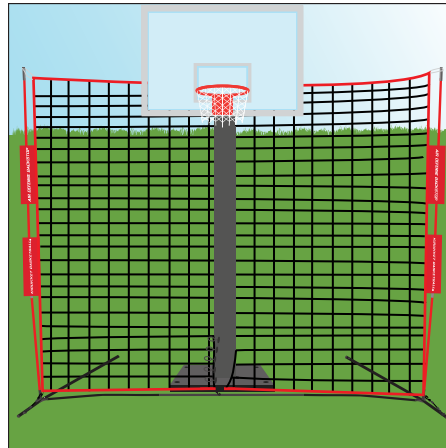

8) Move the net into position behind your basketball goal and then move it forward so that your basketball goal's stand runs up through the net's middle slit. You decide how far forward you want the net.

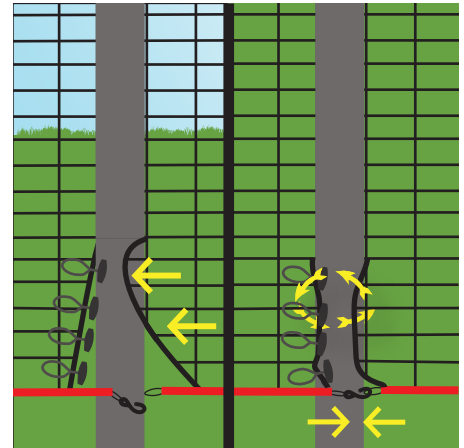

9) When you have the net positioned how you want it, close the slit by running the toggles on the left side of the slit around the black border on the right side of the slit and then back through the loops on the left side of the slit. Attach the black hook on the bottom left of the slit to the loop on the bottom right to unite the bottom edge of the net.

The stakes will help in windy conditions.

WARNING



Please use adult supervision and follow the instructions when setting up and using this net. Regular use or abuse will eventually strain the netting and may break it. Do not stand behind the net. This net is not intended for personal protection. Failure to follow these precautions could result in serious injury or damage to property.