

HAACK GOLF NET ASSEMBLY INSTRUCTIONS

Our video instructions provide the best guidance for setting up your Haack Golf Net.
They can be viewed online at

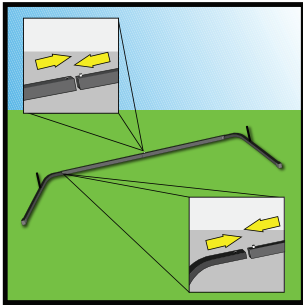

Please call us if you have any questions or concerns at **1-855-4RUKKET**
Please read our product safety warnings before setup



1. Assemble the frame.

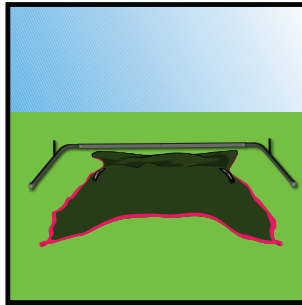

2. Lay the net out with the sleeves on top and the black border near the rear cross-bar.

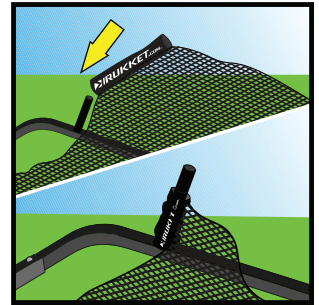

3. Place the sleeves over the vertical posts with Rukket.com facing inside the corner and Haack Golf Net facing the outside of the frame.

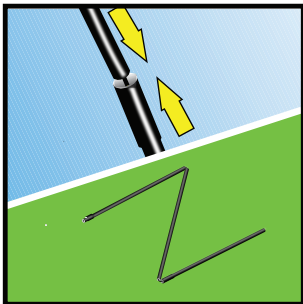

4. Assemble the fiberglass poles.

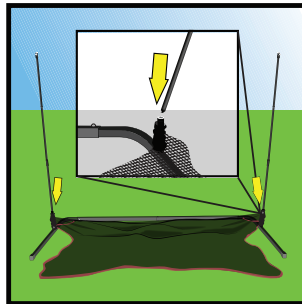

5. Insert the fiberglass poles into the frame posts.

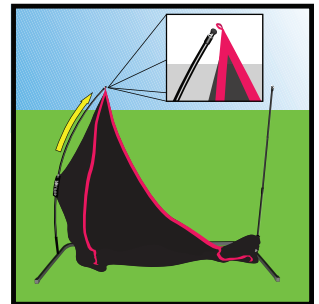

6. Attach the red loops to the tops of the fiberglass poles.

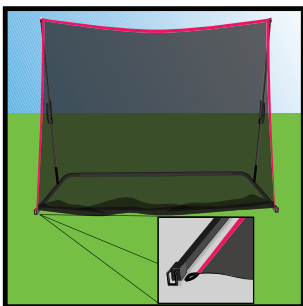

7. Attach the lower black loops to the ends of the legs.

!! WARNING !!

- Please use adult supervision and follow the instructions when setting up and using the net.
- **REGULAR** use or abuse will eventually strain the netting and may break it.
- Do not stand behind the net.
- This net is not intended for personal protection.

PRIOR TO USE

- Inspect the netting and frame for damage or wear.
- Make sure the frame and net are assembled correctly and on a flat surface, at least ten (10) feet away from structures and vehicles.
- The user should be positioned directly in front of the net.
- Failure to follow these precautions could result in serious injury or damage to property.

QUESTIONS? GIVE US A CALL! (1-855)-478-5538



HAACK GOLF NET ASSEMBLY INSTRUCTIONS

WHAT'S INCLUDED

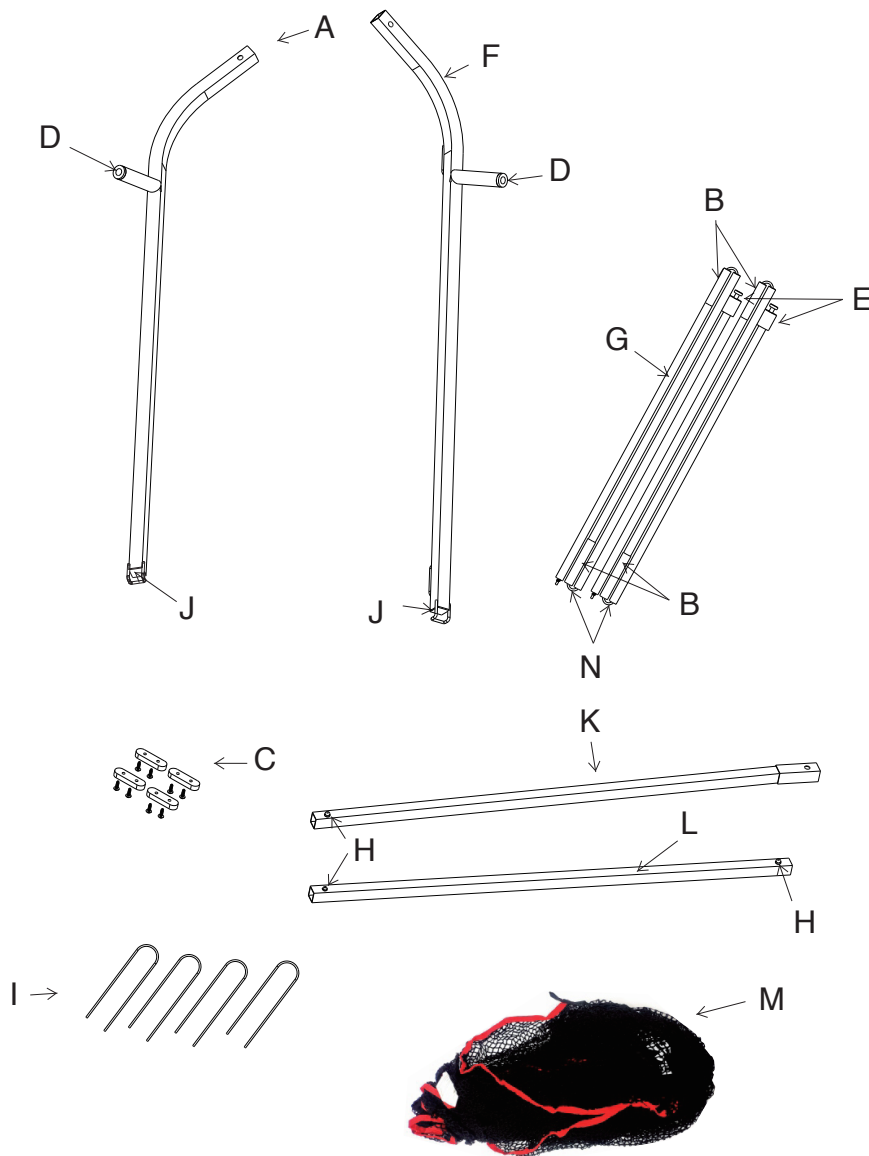

- A: Left front leg tube
- B: Fiberglass connecting iron sleeve
- C: Silicone pads
- D: Plastic pipe plug with fiber rod
- E: Top plastic parts
- F: Right front leg tubes
- G: Fiberglass
- H: Single-sided snap fastener
- I: Metal stakes
- J: Pipe plug plastic parts
- K: Left connecting pipe
- L: Right connecting pipe
- M: Golf net
- N: Bungees inside the fiberglass

QUESTIONS? GIVE US A CALL! (1-855)-478-5538