

# 7X7 SOCK IT! BASEBALL/SOFTBALL NET ASSEMBLY INSTRUCTIONS

Our video instructions provide the best guidance for setting up your 7x7 Sock it! Baseball/Softball Net. They can be viewed online at



Please call us if you have any questions or concerns at **1-855-4RUKKET**  
Please read our product safety warnings before setup

## INCLUDED EQUIPMENT

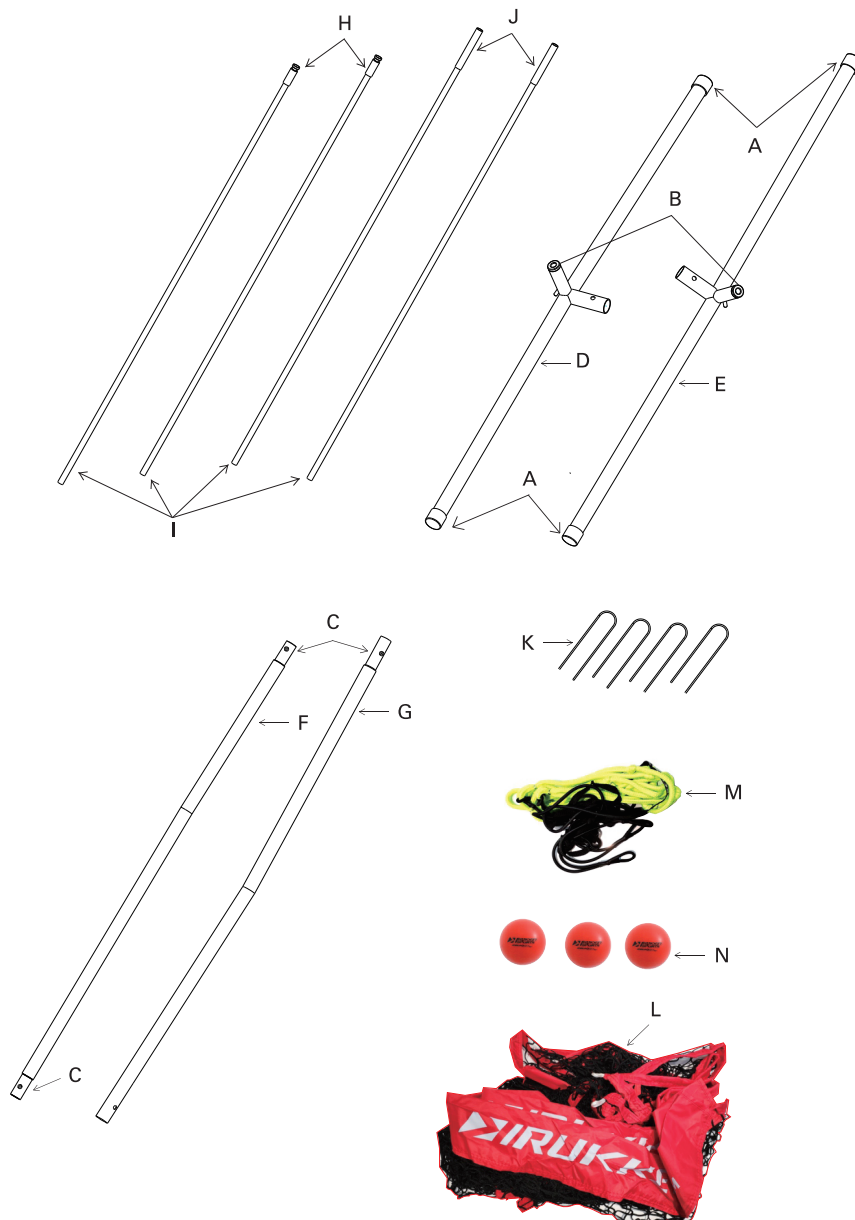

- A. PVC Cap
- B. Plug for Support Tubes
- C. Metal Spring Button
- D. Left Support Tube
- E. Right Support Tube
- F. Double-Taper Tube
- G. Single-Taper Tube
- H. Aluminum Cap for  
Fiberglass Rod
- I. Fiberglass Poles
- J. Aluminum Connector for  
Fiberglass Pole
- K. Metal Stakes
- L. Net
- M. Target
- N. Weighted Balls

QUESTIONS? GIVE US A CALL! (1-855)-478-5538



# 7X7 SOCK IT! BASEBALL/SOFTBALL NET ASSEMBLY INSTRUCTIONS

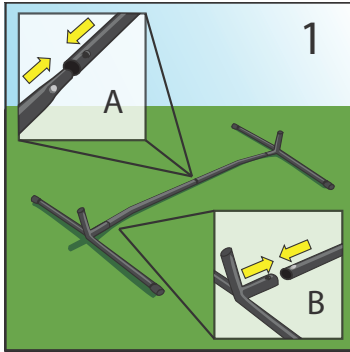

1. Join the two slightly bent pipes together (Fig. A) Then attach both end legs (Fig. B)

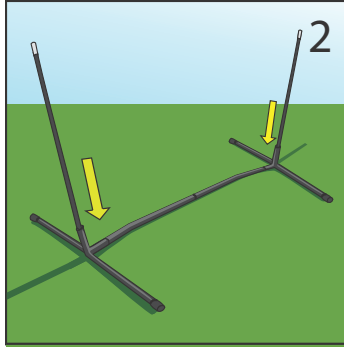

2. Install the two lower fiberglass poles, with coupling tubes at the top, into the angled pipes on the metal base.

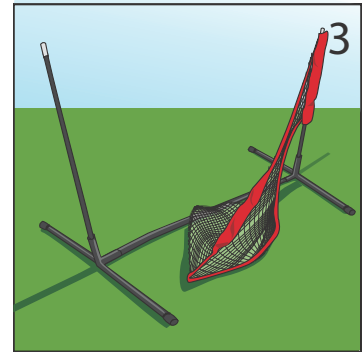

3. Thread a fiberglass pole through one of the net's sleeves making sure the net is right side up (white loops at the top corners and black bungees at the bottom corners).

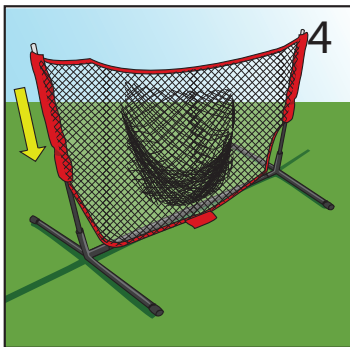

4. Repeat for the other side.

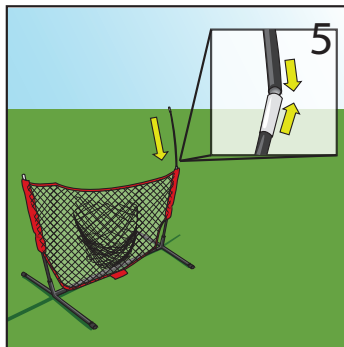

5. Insert an upper fiberglass pole into one of the lower pole's coupling tube. The metal knob should be at the top.

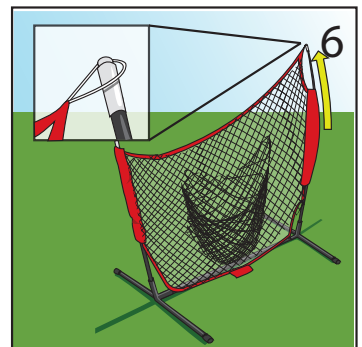

6. Gripping the assembled fiberglass pole, slide the net's sleeve up the pole and loop the white rope onto the metal knob on top.

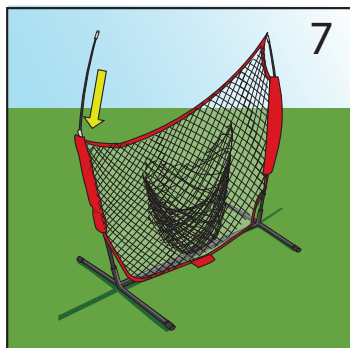

7. Insert the remaining upper fiberglass pole into the remaining lower pole.

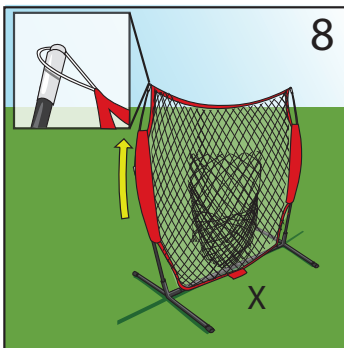

8. Grip the pole and slide the sleeve up before looping the white rope around the metal pole top.

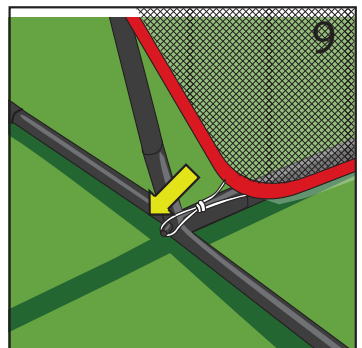

9. Loop the black elastic bungees over the metal posts located on the outside of each end leg. 10. Wrap the velcro around the frame (X in Fig. 8).