

ELAC

SUBWOOFERS

MODELS : SUB1015, SUB1025, SUB1225



OWNER'S MANUAL



Thank you, and Congratulations on bringing home an ELAC Subwoofer.

ELAC subwoofer series are designed to deliver powerful and deep bass notes. These subwoofers are offered in 10 and 12 inches allowing you to choose your needs and space constraints.

Designed with affordability in mind, the subwoofer series offers a budget-friendly option that is suitable for those who are just starting to explore the world of enhanced audio systems. Despite being entry level, these subwoofers still deliver notable performance with their solid construction, reliable components and optimized design.

Installation is made easy with full range of features, including High-Level input for stereo integration.

Enjoy!

If you have any questions about your Subwoofer, please contact us directly.

www.elac.com • customerservice@elac.us • (714)-252-8843

JOURNEY TOGETHER THROUGH - THE LIFE OF SOUND

CONTENTS

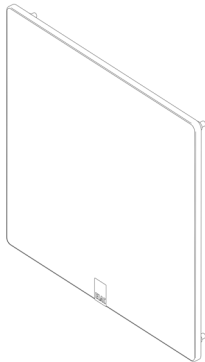

GRILLE

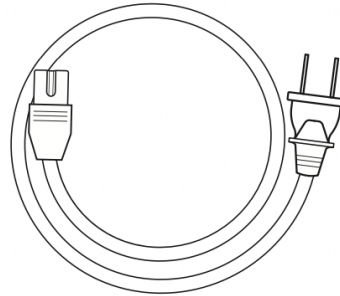

POWER CORD

BACK PANEL FEATURES

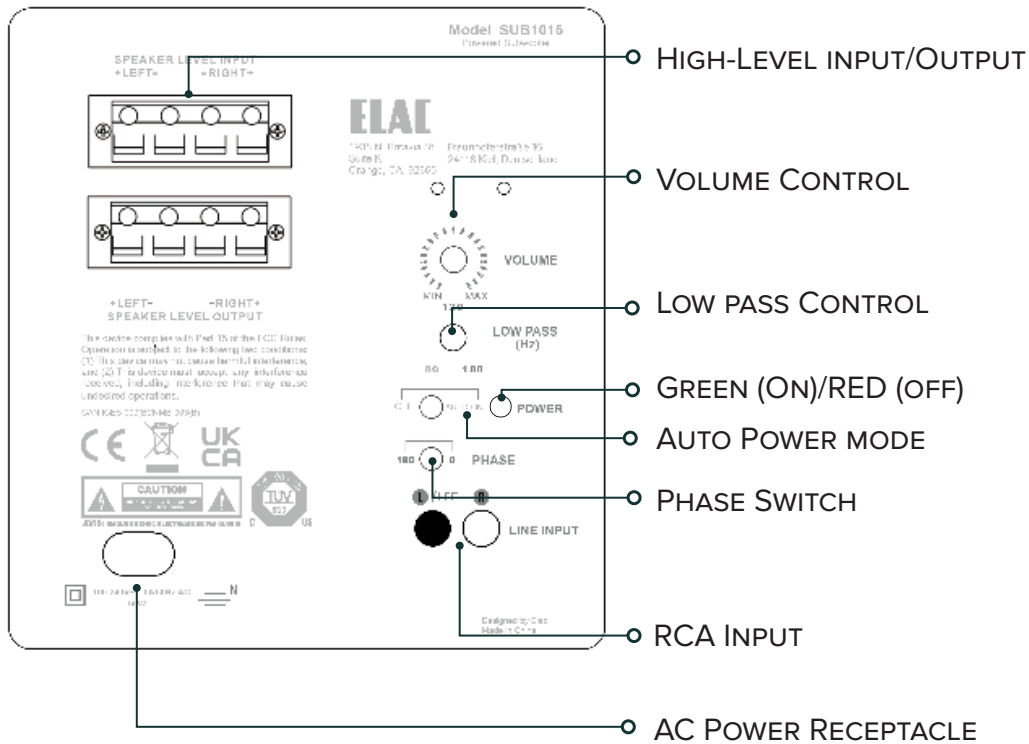

CONNECTING YOUR SUBWOOFER

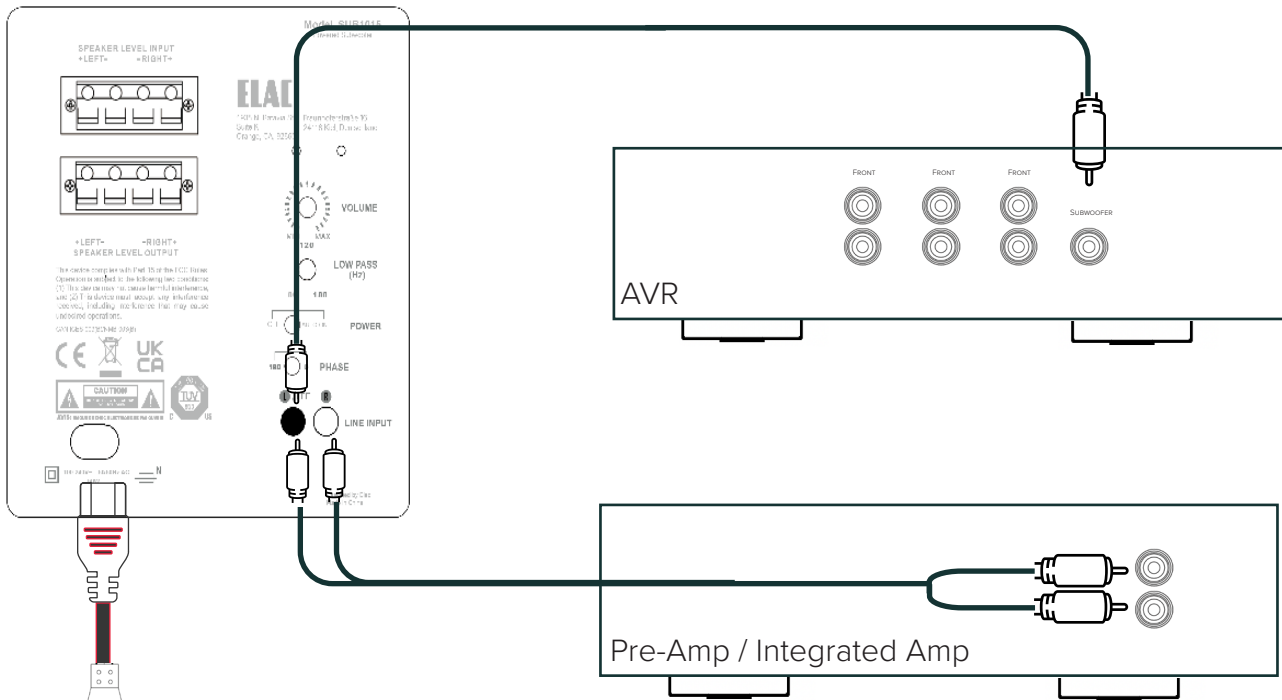

1. If using an AV receiver with a subwoofer output connect a single RCA cable from the subwoofer out to the Right/LFE input on the subwoofer.
2. If your receiver, pre-amp, or integrated amplifier does not have a dedicated subwoofer output connect a set of stereo RCA connectors from the pre-outs (variable) from your pre-amp and integrated amp to the rca inputs on the subwoofer.
3. Turn on power switch to "ON" position



FRONT PLACEMENT

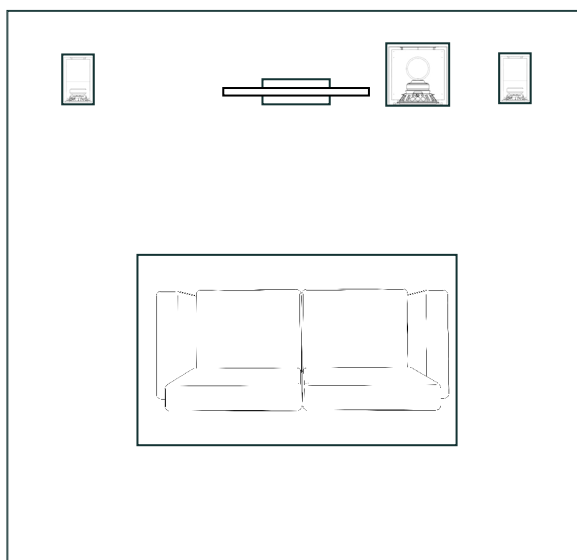

If you believe you are getting too much bass from having your subwoofer located in a corner of the room, you can position the subwoofer between your front left and right speakers.

This will reduce "loading" of bass and can aid in reducing localization of bass frequencies.

CORNER PLACEMENT

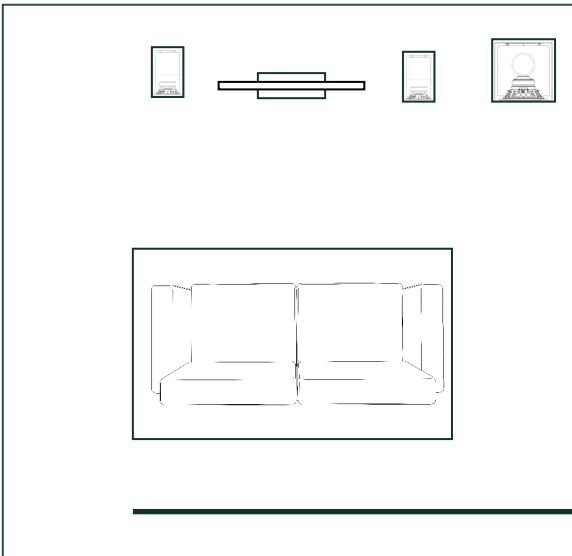

Placing a subwoofer in a corner excites most room modes and offers the best chance of avoiding a null area (a part of the room that experiences an acoustic reduction in bass).

DUAL PLACEMENT

Utilizing dual subwoofers can help distribute bass frequencies more evenly and provide better coverage in the room.

Since every room is unique, if possible the best option is to move the subwoofers around the room and find the location that sounds the best from your normal listening position. There are many test discs you can purchase that provide the correct test signals for helping find this optimum location.

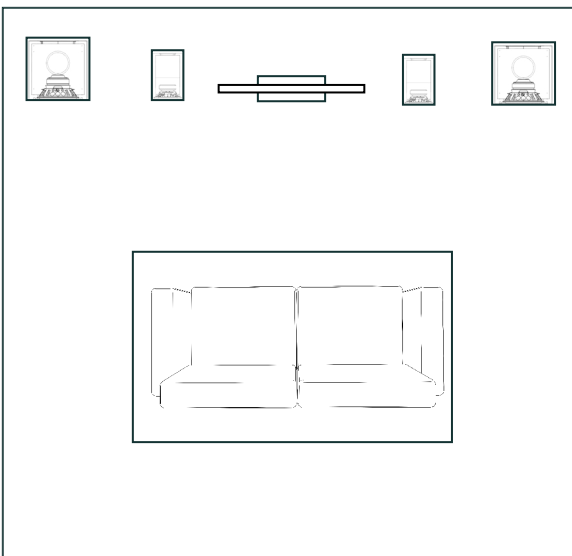

Front stage in the corners or adjacent to the center channel.

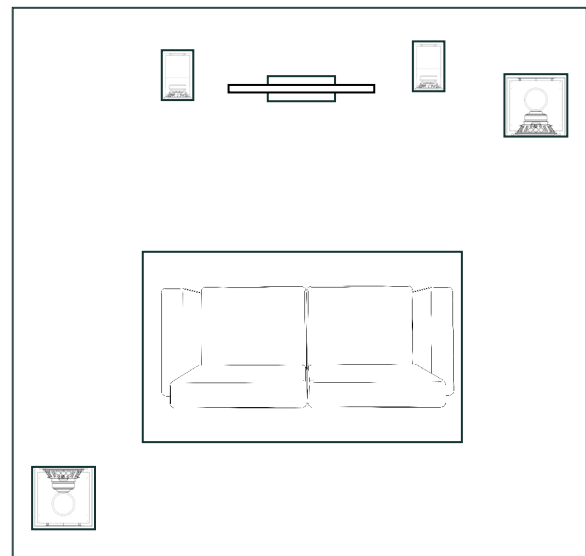

Opposite diagonal front and rear.

SPECIFICATIONS

	SUB1015-BK	SUB1025-BK	SUB1225-BK
SPEAKER TYPE	BASS REFLEX		
WOOFER	10" POLYPROPYLENE CONE	10" POLYPROPYLENE CONE	12" POLYPROPYLENE CONE
FREQUENCY RESPONSE	36HZ TO 150HZ	36HZ TO 150HZ	33HZ TO 150HZ
LOW PASS CROSSOVER, HZ	50HZ TO 150HZ	50HZ TO 150HZ	50HZ TO 150HZ
MAXIMUM/PEAK POWER	60/100 WATTS	100/200 WATTS	150/350 WATTS
Amplifier Topology	CLASS D		
Standby Power Consumption	< 0.5W		
Inputs	RCA LINE LEVEL, SPEAKER LEVEL		
Cabinet Finish	BLACK ASH		
Accessories Included	GRILLE, AC POWER CORD		
Height	325 MM	325 MM	375 MM
Width	310 MM	310 MM	360 MM
Depth	368 MM	368 MM	420 MM
Net Weight (Product)	9.8 KG	10.3 KG	14.0 KG
Gross Weight	11.5 KG	12.0 KG	16.0 KG

SAFETY INSTRUCTIONS

1. General information

- Please read and follow these safety instructions.
- Keep them safe for future reference.
- Observe all warnings on the speaker and in the manual. Please check the speaker for damage before use. The speaker must be in perfect working condition. Damaged parts may lead to personal injury.

2. Use only as directed

- Connect the speaker(s) according to the instructions in the manual.
- Many ELAC speakers are equipped with spikes and/or anti-slip feet. They are explicitly provided for leveling the speaker. For leveling on an uneven floor, unscrew the spikes or anti-slip feet by 2-3 turns of thread. The speaker should always be in perfect vertical alignment: the stability of the speaker must not be compromised by using spikes or anti-slip feet as the speaker may tip-over.

3. Location

- Install the speakers on a level surface only.
- When choosing the location of these speakers do not place them in locations that are:
 - In direct sunlight
 - Very humid
 - Prone to vibrations
 - Exceptionally hot or cold
 - Near CRT Televisions (the speakers are not magnetically shielded and may cause color issues with a CRT based TV)
 - Close to magnetic cards (Since the speakers are not magnetically shielded placing magnetic cards such as credit cards or commuter cards may cause them to fail).

4. Overload

Please ensure the product is perfectly stable to avoid injury from tip-over. Please note, that stability can be increased by using spikes on carpeted surfaces. However, the mounting of spikes must be carried out carefully due to their very sharp ends which may cause injuries. The stability on slippery floors can be increased by using Velcro fastening tape or double-sided adhesive tape. Do not install the speaker near any heat sources such as radiators, heating valves, stoves, or other apparatus (including amplifiers) that produce heat, or in areas where there is a risk of explosion.

- Do not block any ventilation openings. Install in accordance with the manufacturer's instructions.
- Do not install the speaker in a closed rack or in a closed cupboard.
- Do not put burning candles on or near the speaker.
- Do not install the speaker near transformers because electromagnetic stray fields can cause hum noise on woofers.
- In combination with certain materials / lacquers / material surfaces, anti-slip feet or spike washers may cause colored imprints on the surfaces.

Extreme overload of the device due to very high volume may cause individual components to blow. Because of the possible danger, you should never leave loudspeakers under extreme overload conditions unattended.

5. Service

DANGER! Do not open the cabinet because the components and conductors may carry dangerous levels of electricity! Servicing to be carried out by qualified service personnel only.

Servicing is required when the loudspeaker has been damaged in any way, such as damage to the power supply cord or the plug, or when liquid has been spilled or objects have fallen into the loudspeaker, the speaker has been exposed to rain or moisture, does not operate normally, or has been dropped. To reduce the risk of electric shock, do not open the loudspeaker. Servicing to be carried out by qualified service personnel only .

6. Fuse links

Various faults in subwoofers or active speakers may cause the fuse to blow. If the fuse blows, only replace it with the correct fuse type and rating as shown on the rear of the loudspeaker on the fuse holder. A second fuse is included with the device (in the fuse holder beneath the mains socket).

7. Cleaning

NOTE: Clean only with soft, smooth cloth or with dust brush. Do not use scouring agents, alcohol, benzene, furniture polish or other agents for cleaning! Modern furniture is often coated with multiple varnishes and plastics which can be treated with chemical agents. Some of these agents contain substances which degrade or soften the rubber feet. Therefore, we advise you to place an anti-slip mat underneath the loudspeaker.

8. Volume

CAUTION! Continuous high volume may cause severe damage to your hearing. Please listen responsibly.

9. Disposal

The packaging is made from recyclable materials. Dispose of this in an environmentally friendly manner. At end of product life do not dispose of the speaker(s) with standard household waste. The speaker must be recycled in accordance with local legislation. Ask your local government for further information on recycling as the device contains valuable raw materials. Disable the speaker before disposal.

10. Power

This subwoofer is only intended to be connected to voltages that are listed on the rear panel of the cabinet. Connection to any other voltage may cause irreversible damage to the subwoofer and will void the warranty. Use of plug adapters is not recommended because they may allow connection to voltages other than those printed on the back of this subwoofer.

WARRANTY

ELAC Americas Inc.

North America Limited Liability Warranty

ELAC Americas Inc. warrants to the original purchaser that this product be free from defects and or workmanship for a period of 1 (One) year from the original date of purchase. During this time period, repair or replacement of parts will be free of charge to the original owner (See below limitations). Shipping to and return from the repair center will be the responsibility of the original purchaser.

Limitations

- Warranty begins on the date of original purchase from an authorized ELAC Americas Inc. dealer.
- Product is warranted only if used in home applications within the max power rating specified in this manual. Commercial use of this product is not warranted.
- Product that has been modified or altered in anyway will not be warranted.
- Product that has been abused or subjected to faulty equipment will not be warranted.
- Products with defaced or removed serial numbers will not be warranted.

If service is required

In the event that service is required, please contact ELAC America at 888-541-0996 or at customerservice@elac.us to arrange for service or replacement. You will be responsible to provide proof of purchase (Copy or original sales receipt). Shipping to and from our repair center will be the responsibility of the original purchaser.

Warranty Outside of North America

This warranty applies to products purchased in the United States and Canada. For warranty claims outside of North America please contact the local dealer/distributor in the country of purchase.

ELAC The life of sound.

ELAC AMERICAS INC.
1938 N. BATAVIA St. SUITE K
ORANGE, CA 92865

ELAC ELECTROACUSTIC GMBH
FRAUNHOFERSTRASSE 16
D-24118 KIEL, GERMANY