



testo 560i and testo Smart Valve
0564 1560
0560 5600

Instruction manual



Contents

1	About this document	3
2	Safety and disposal	3
3	Product-specific approvals	3
4	Product-specific information	4
5	Intended use	5
6	Product description	6
6.1	Overview of testo 560i	6
6.2	Overview of testo Smart Valve	7
7	First steps	8
7.1	Inserting (rechargeable) batteries	8
7.2	Switching the instrument on and off	9
7.3	Establishing a Bluetooth® connection	9
7.3.1	Establishing a Bluetooth® connection to the testo Smart App	10
7.3.2	Establishing a Bluetooth® connection to the testo 550s / testo 557s manifold	10
7.3.2.1	Switching on	11
7.3.2.2	Switching off	11
8	Using the product	12
8.1	Control via app	13
8.1.1	Creating and editing a customer	15
8.1.2	Creating and editing measuring sites	16
8.1.3	Searching for and deleting measurement results	17
8.1.4	Sensors	18
8.1.4.1	Information	18
8.1.4.2	Settings	19
8.1.5	Language	19
8.1.6	Measurement settings	20
8.1.7	Company details	20
8.1.8	Privacy settings	20
8.1.9	Help and Information	21
8.1.9.1	Instrument information	21
8.1.9.2	Tutorial	21
8.1.9.3	Exclusion of liability	21
8.2	Control via manifold	22
8.3	Connecting the instruments	23





Contents

8.4	Manual charging via weight	24
8.5	Automatic charging by target weight.....	26
8.6	Automatic charging by target superheat	28
8.7	Automatic charging by target subcooling	30
8.8	Automatic charging via target superheat	32
9	Maintenance	34
9.1	Calibration	34
9.2	Cleaning instruments	34
9.3	Keeping connections clean	34
9.4	Removing oil residues	34
9.5	Ensuring measuring accuracy	34
9.6	Changing batteries/rechargeable batteries	35
10	Technical data	36
10.1	Technical data for testo 560i.....	36
10.2	Technical data for testo Smart Valve	37
11	Tips and assistance	37
11.1	Accessories	37
12	Support	38

1 About this document

- The instruction manual is an integral part of the instrument.
- Pay particular attention to the safety instructions and warning advice in order to prevent injury and damage to the product.
- Please read this instruction manual through carefully and familiarize yourself with the product before putting it to use.
- Familiarity with a PC as well as the Microsoft® products is assumed in this documentation.

Symbols and writing standards

Display	Explanation
	Note: basic or further information
	Warning advice, risk level according to the signal word: Warning! Serious physical injury may occur. Caution! Minor physical injury or damage to the equipment may occur. Careful! Possible damage to equipment. - Implement the specified precautionary measures.
1 2 ...	Action: several steps, the sequence must be followed
	Result of an action
	Requirement
Menu	Elements of the instrument, the instrument display or the program interface.
[OK]	Control keys of the instrument or buttons of the program interface.

2 Safety and disposal

Please observe the **Testo information** document (enclosed with the product).

3 Product-specific approvals

For the relevant country approvals, please refer to the printed quick reference guides or short instructions enclosed with the products.

4 Product-specific information

- The instrument being dropped or any other comparable mechanical stress may result in breakage of the pipe sections in the refrigerant hoses. The valve positioners may also suffer damage, causing further damage inside the measuring instrument that is not necessarily visible externally. Therefore, always replace the refrigerant hoses with new ones after the measuring instrument is dropped or after any comparable mechanical stress. For your own safety, return the instrument to Testo Customer Service for technical inspection.
- Electrostatic charging may destroy the instrument. Integrate all the components (system, manifold's valve block, refrigerant bottle, etc.) into the equipotential bonding (earthing). Please see the safety instructions for the system and the refrigerant used.
- Refrigerant gases can harm the environment. Please note the applicable environmental regulations.
- Use with A2L refrigerants

Testo measuring instruments (as of July 2020) can be used in compliance with the prescribed laws, standards, directives and safety regulations for refrigeration systems and refrigerants as well as regulations of the manufacturers of refrigerants of safety group A2L as per ISO 817.

Regional standardization and interpretation must always be observed.

For example, DIN EN 378-Part 1-4 applies to the scope of the EN standards.

During maintenance work, the employer must ensure that a hazardous explosive atmosphere is prevented (see also TRBS1112, TRBS2152 VDMA 24020-3).

A hazardous and potentially explosive atmosphere must be anticipated during maintenance and repair work on refrigeration systems with flammable refrigerants (e.g. those in category A2L and A3).

Maintenance, repairs, removal of refrigerants and commissioning of systems may only be carried out by qualified personnel.

5 Intended use

The **testo 560i** scale and the **testo Smart Valve** are aids for carrying out maintenance and service work on refrigeration systems and heat pumps. They may only be used by qualified authorized personnel.

Via their functions, the instruments help with charging refrigeration systems and heat pumps.

The **testo 560i** and **testo Smart Valve** can be used either in conjunction with the **testo Smart App** or in conjunction with one of the **testo 550s** and **testo 557s** manifolds.

The **testo Smart Valve** is compatible with most non-corrosive refrigerants, water and glycol. The **testo Smart Valve** is not compatible with refrigerants containing ammonia.

The products are suitable for gaseous charging of refrigeration systems.

When charging with liquid refrigerant, an evaporation adapter must be used to protect the compressor or the flow rate limited via the manifold.

ATTENTION

Charging liquid refrigerant too quickly can damage the compressor!

- **Only charge liquid refrigerant slowly.**

The products must not be used in potentially explosive atmospheres!

The **testo Smart Valve** must not be used in the vicinity of a magnetic field.

ATTENTION

Danger due to leaking refrigerant.

The **testo Smart Valve does not constitute a safety mechanism.**

- **Stop the flow of refrigerant at the refrigerant bottle once the charging process has been completed.**
- **Always stop the flow of refrigerant from the refrigerant bottle to the **testo Smart Valve** when not in use.**



Always hang the **testo Smart Valve** up straight using the hook and make sure that the scale and the valve are always level/horizontal.

6 Product description

6.1 Overview of testo 560i

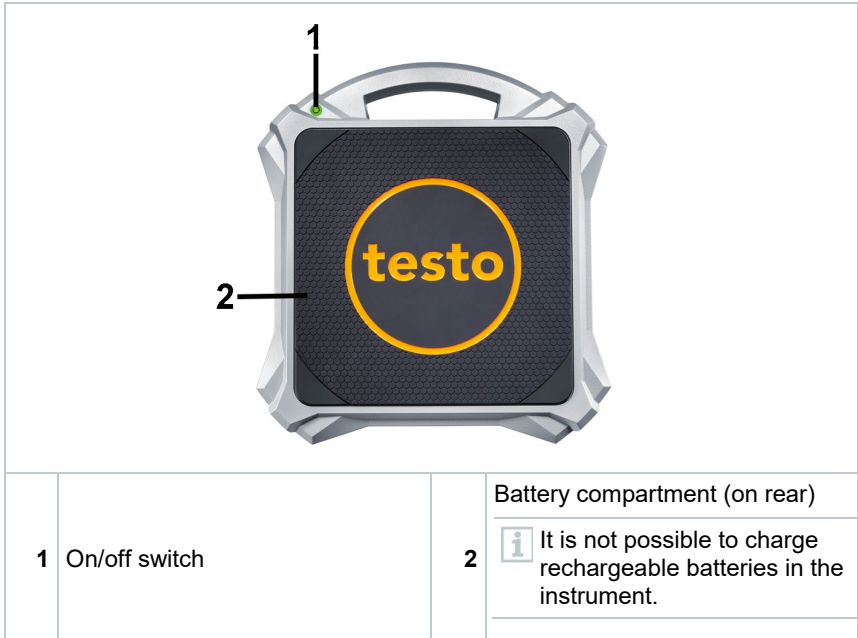

6.2 Overview of testo Smart Valve



1	Folding suspension device (rear)	2 On/off switch - 1x click: Switch on - Hold down: Switch off - 3x clicks: Open valve for 1 s
3	Status LED - Constant red: Valve open	4 Battery compartment (on rear)  It is not possible to charge rechargeable batteries in the instrument.
5	Refrigerant outlet: Connection 7/16" UNF, brass. For refrigerant hoses with quick-release fitting, passage can be closed via valve positioner.	6 Refrigerant inlet: Connection 7/16" UNF, brass. For refrigerant hoses with quick-release fitting, passage can be closed via valve positioner.

7 First steps

7.1 Inserting (rechargeable) batteries

Inserting batteries/rechargeable batteries in the testo 560i

- 1 | Open battery compartment.
 - 2 | Insert the batteries (scope of delivery) or rechargeable batteries (4 x 1.5V, type AA / Mignon / LR6) into the battery compartment. Observe the polarity!
 - 3 | Close the battery compartment.
- ▶ After inserting the batteries, the instrument switches on automatically and is in Bluetooth® connection mode.



In Bluetooth® connection mode, connection can be established to the **testo Smart App** or to a **testo 550s** or **testo 557s** manifold.



Do not change or remove batteries during operation, otherwise the charging process will be interrupted.



When not in use for a long period: Take out the (rechargeable) batteries.

Inserting batteries/rechargeable batteries in the testo Smart Valve

- 1 | Unfold the suspension hook and open the battery compartment (clip lock).
 - 2 | Insert the battery (supplied) or rechargeable battery (1 x 9.0V (6LR61) block battery) into the battery compartment. Observe the polarity!
 - 3 | Close the battery compartment.
- ▶ After inserting the batteries, the instrument switches on automatically and is in Bluetooth® connection mode.



In Bluetooth® connection mode, connection can be established to the **testo Smart App** or to a **testo 550s** or **testo 557s** manifold.



Do not change or remove batteries during operation, otherwise the charging process will be interrupted.



When not in use for a long period: Take out the (rechargeable) batteries.

7.2 Switching the instrument on and off

Switching on testo 560i

- 1 Press the ON key.
 - ▶ The instrument switches on and is in Bluetooth® connection mode.



In Bluetooth® connection mode, connection can be established to the **testo Smart App** or to a **testo 550s** or **testo 557s** manifold.

- 2 Press and hold the ON key.
 - ▶ The instrument is switched off.

Switching on Testo Smart Valve

- ✓ Do not switch on Testo Smart Valve until all hoses have been attached and the installation is ready for charging.
- 1 Press the ON key.
 - ▶ The instrument switches on and is in Bluetooth® connection mode.



In Bluetooth® connection mode, connection can be established to the **testo Smart App** or to a **testo 550s** or **testo 557s** manifold.

- 2 Press and hold the ON key.
 - ▶ The instrument is switched off.

7.3 Establishing a Bluetooth® connection

- ✓ The **testo 560i** scale or the **testo Smart Valve** are switched on.

7.3.1 Establishing a Bluetooth® connection to the testo Smart App



To establish a connection via Bluetooth®, you need a tablet or smartphone with the Testo Smart App already installed on it.

You can obtain the app for iOS devices from the App Store, for Android devices from the Play Store or by scanning the QR code in the manifold.



Compatibility:

Requires iOS 12.0 or later/Android 6.0 or later, requires Bluetooth® 4.0.

- 1 | Open Testo Smart App.
 - ▶ | The app automatically searches for Bluetooth® devices in the vicinity.
- 2 | In the **Bluetooth** menu, check whether the required instrument is connected.
 - ▶ | If necessary, switch the instrument to be connected off and on again to restart the connection mode.

7.3.2 Establishing a Bluetooth® connection to the testo 550s / testo 557s manifold

- ✓ | The instrument is switched on and the measurement menu is displayed.

- 1 | Press **[Menu/Enter]**.
- 2 | Use **[▲] / [▼]** to select **Bluetooth** and **[Menu/Enter]** to confirm.

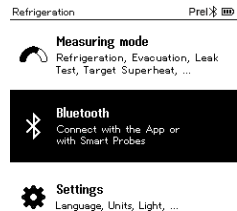

- ▶ The **Bluetooth** menu is displayed.

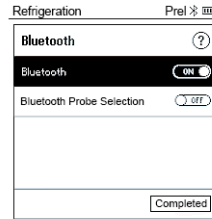

7.3.2.1 Switching on

- ✓ The **Bluetooth** menu is selected.

1 [Menu/Enter]

- ▶ In the On/Off switch icon, **ON** is displayed.



- 2 Enable Bluetooth®: Use [▼] to activate the **Completed** button and [Menu/Enter] to confirm.

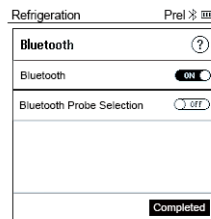

- ▶ When the Bluetooth® icon appears on the display, Bluetooth® is switched on.
- ▶ Bluetooth® automatically searches for and connects available devices.
- ▶ If necessary, switch the instrument to be connected off and on again to restart the connection mode.

7.3.2.2 Switching off

- ✓ The Bluetooth® menu is activated.

1 [Menu/Enter]

- ▶ In the On/Off switch icon, **OFF** is displayed.



- 3 Disable Bluetooth®: Use [▼] to activate the [Completed] button and [Menu/Enter] to confirm.

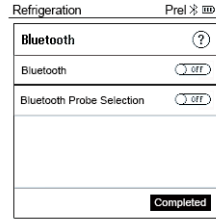

- ▶ When the Bluetooth® icon is not shown on the display, Bluetooth® is switched off.

8 Using the product

The **testo 560i** scale and the **testo Smart Valve** can either be used in conjunction with the **testo Smart App** or in conjunction with one of the **testo 550s** and **testo 557s** manifolds.



This product is suitable for gaseous charging of refrigeration systems. When charging with liquid refrigerant, an evaporation adapter must be used to protect the compressor or the flow rate limited via the manifold. The valve opens and attempts to fill with the set charge quantity. When charging by target weight, no pulsating charging takes place.

ATTENTION

Charging liquid refrigerant too quickly can damage the compressor!

- **Only charge liquid refrigerant slowly.**



It is necessary to enter the maximum capacity of the system to prevent overcharging.



Despite automation, the system can be overcharged. Reasons for this may be due to specific local or system-specific conditions. The technician must always monitor the automatic charging.



If the superheat cannot be measured (display shows xx° superheat), then automatic charging cannot be started. Measuring the superheat forms the basis for automatic charging.



Generally, charging stops in the following situations:

- The weight on the scale changes suddenly or involuntarily.
- The maximum charge quantity has been reached, although the final value (SH/SC) has not yet been reached.





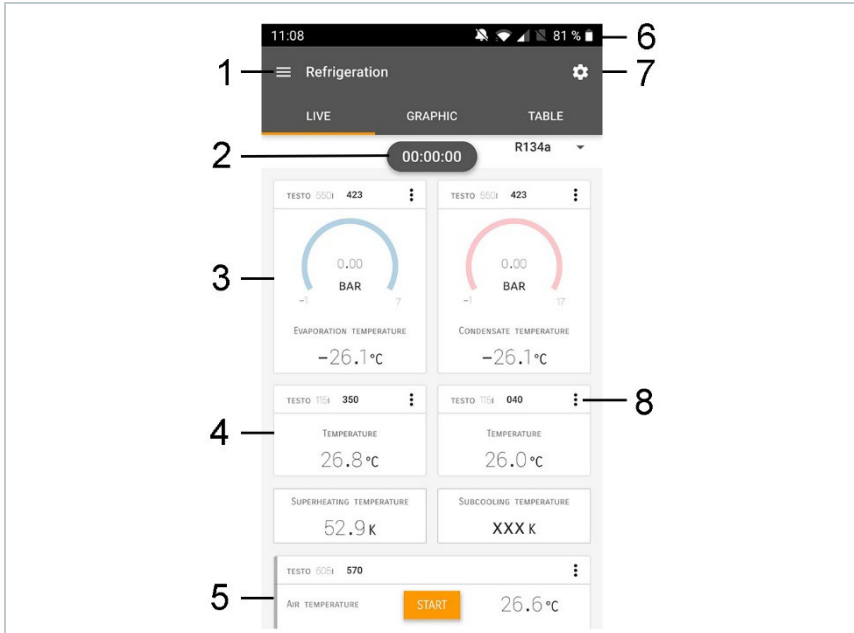



8.1 Control via app

- ✓ Scale and valve are switched on.
- ✓ The app is installed on the smartphone and connected to the valve and scale via Bluetooth®.
- ▶ Settings and controls are implemented via the app.







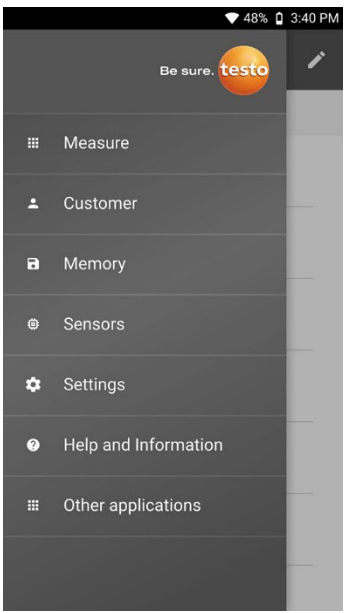

1		Open main menu
2		Display of the measurement period
3		Display of the maximum system charging
4		Reading for each probe
5		Can be controlled with different function keys
6		Instrument status bar
7		Configuration
8		Edit reading display

Further symbols on the user interface (without numbering)



	One level back
	Exit view
	Share measurement data/report
	Search
	Favourite
	Deleting
	Further information
	Display report
	Multiple selection

The **Main menu** can be accessed via the  icon at top left. To exit the main menu, select a menu or right-click on the guided menus. The last screen displayed is shown.

	Measure	
	Customer	
	Memory	
	Sensors	
	Settings	
	Help and Information	
	Other applications	

8.1.1 Creating and editing a customer

In the **Customer** menu, all customer and measuring site information can be created, edited and deleted. Fields marked with * are mandatory. Without any information in this field, no customers or measuring sites can be stored.

- 1 Click on .
- ▶ Main menu opens.
- 2  Click on **Customer**.
- ▶ The **Customer** menu opens.
- 3 Click on **+ New Customer**.
- ▶ A new customer can be created.
- 4 Store all relevant customer data.

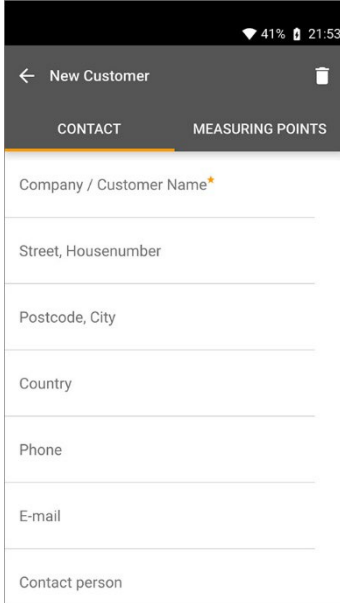



The screenshot shows a mobile application interface for creating a new customer. The top bar is dark with a back arrow, the text "New Customer", and a trash icon. Below this is a tabbed interface with "CONTACT" selected and "MEASURING POINTS" visible. The form contains the following fields:

- Company / Customer Name*
- Street, Housenumber
- Postcode, City
- Country
- Phone
- E-mail
- Contact person

- 5 Click on **Save**.
- ▶ The new customer was saved.

8.1.2 Creating and editing measuring sites

- 1 Click on .
- ▶ Main menu opens.
- 2  Click on **Customer**.
- ▶ The **Customer** menu opens.
- 3 Click on **+ New Customer**.
- 4 Click on right tab **Measuring Points**.
- 5 Click on **+ New Measuring Point**.
- ▶ A new measuring point can be created.
- 6 Store all relevant measuring site information.
- 7 Click on right tab **Parameters**.

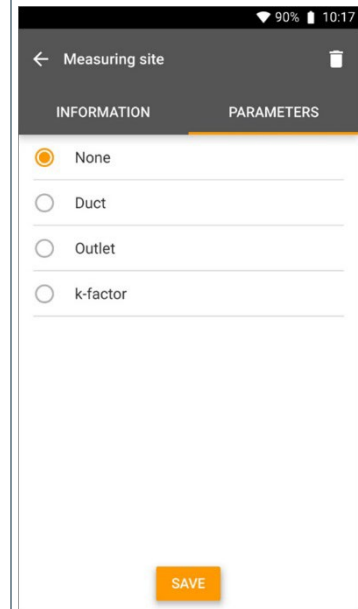

- 8 Select further parameters.



For the duct, outlet or duct with k-factor measuring points, further parameter settings can be implemented.

- 9 | Click on **Save**.
- ▶ | The new measuring site has been saved.

8.1.3 Searching for and deleting measurement results



In the **Memory** menu, you can call up all the stored measurements, analyze them in detail and also create and save csv data and PDF reports. When clicking on a measurement, an overview of the measurement results is displayed.

In the **Memory** menu, all stored measurements are sorted by date and time.

Searching

- ✓ | The **Memory** menu is open.
- 1 | Click on .
- ▶ | Search field with measurements opens.
- 2 | Enter the customer name or measuring site or date/time in the search field.
- ▶ | The result is displayed.

Deleting

- 1 | Click on .
- ▶ | A check box is displayed in front of each measurement.
- 2 | Click on the required measurement.
- ▶ | A tick is displayed in the respective box.
- 3 | Click on .
- ▶ | Information window is displayed.
- 4 | Acknowledge the information.

- ▶ Selected measurements were deleted.

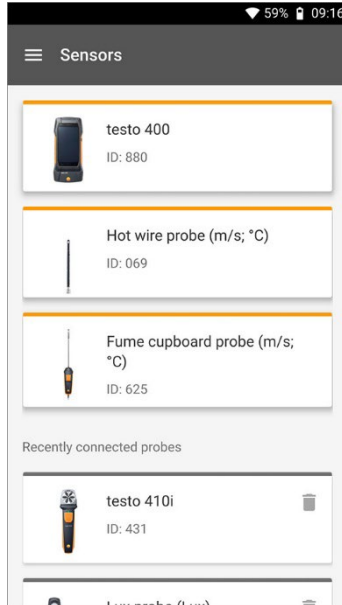

8.1.4 Sensors

All sensors used with the App can be found in the  **Sensors** menu. There, you can view general information about currently connected probes as well as recently connected probes.



8.1.4.1 Information



Information is stored for each probe.

- ✓ The app is connected to **testo 550s / testo 557s**.
- 1 Click on .
- ▶ Main menu opens.
- 2  Click on **Sensors**.
- ▶ The **Sensors** menu opens.
- 3 Click on one of the displayed probes.

- ▶ Information is displayed about the model, order number, serial number and firmware version.

8.1.4.2 Settings



Settings can also be made for each probe.

- ✓ The probe is connected to the App.
- 1 Click on .
- ▶ Main menu opens.
- 2  Click on **Sensors**.
- ▶ The **Sensors** menu opens.
- 3 Click on one of the displayed probes.
- 4 Click on the **Settings** tab.
- 5 Click on one of the displayed probes.
- ▶ Settings appear that can be changed if necessary.



8.1.5 Language

- 1  Click on **Settings**.
- ▶ The **Settings** menu opens.
- 2 Click on **Language**.
- ▶ A window with different languages opens.
- 3 Click on the required language.
- ▶ The required language is set.

8.1.6 Measurement settings

- 1  Click on **Settings**.
 - ▶ The Settings menu opens.
- 2 Click on **Measurement settings**.
 - ▶ A window with different basic settings for measurement opens.
- 3 Click on the required settings and change if necessary.
 - ▶ The required measurement settings are set.
- 4  Exit **Measurement settings**.

8.1.7 Company details

- 1  Click on **Settings**.
 - ▶ The Settings menu opens.
- 2 Click on **Company details**.
 - ▶ A window with company details opens.
- 3 Click on the required data and enter if necessary.
 - ▶ The required company details are set.
- 4  Exit **Company details**.

8.1.8 Privacy settings

- 1  Click on **Settings**.
 - ▶ The Settings menu opens.
- 2 Click on **Privacy settings**.
 - ▶ A window with privacy settings opens.

3 | Activate or deactivate the required settings.

▶ | The required settings are set.

4 |  Exit **Privacy settings**.

8.1.9 Help and Information

Under Help and Information, you will find information about the **testo 550s / testo 557s**, and the tutorial can be called up and implemented. This also where legal information can be found.

8.1.9.1 Instrument information

1 |  Click on **Help and Information**.

▶ | The **Help and Information** menu opens.

2 | Click on **Instrument information**.

▶ | The current App version, Google Analytics instance ID, refrigerant version and update are displayed for the connected instrument.

Automatic updates for instruments can be enabled or disabled.

> | Use the slider to activate or deactivate **Update for connected instruments**.

8.1.9.2 Tutorial

1 |  Click on **Help and Information**.

▶ | The **Help and Information** menu opens.

2 | Click on **Tutorial**.

▶ | The tutorial shows you the most important steps prior to commissioning.

8.1.9.3 Exclusion of liability

1 |  Click on **Help and Information**.

▶ | The **Help and Information** menu opens.

2 Click on **Exclusion of liability**.

▶ The data protection information and licence usage information is displayed.

8.2 Control via manifold

✓ Scale and valve are switched on.

✓ The manifold is switched on and connected to the valve and scale via Bluetooth®.

✓ The firmware of the manifold is up to date.
The firmware is updated by downloading the latest testo Smart App from the App Store or Play Store.

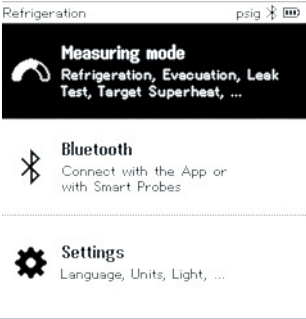

▶ Settings and controls are implemented via the manifold.

Manifold main menu

	
Measuring mode	Refrigeration Evacuation System Leak Test Target Superheat Compressor Test (DLT) Delta T
Bluetooth®	Connection to the testo Smart App or Smart Probes

Settings	Backlight duration Backlight brightness Auto Off Auto Tfac (Temperature compensation factor) Units Language Setup Wizard Restore factory settings Instrument information
-----------------	---

Manifold control keys

Symbol	Meaning
	<ul style="list-style-type: none"> - Open menu - Confirm input - Switch on the display illumination: Press and hold the key for >2s - Switch off the display illumination: Press and hold the key for >2s
	Change/navigate the display screen.
	<ul style="list-style-type: none"> - Switches to the measurement view - Back to the menu - Switch off the instrument: Press and hold the key for >2s

8.3 Connecting the instruments



Before each use, make sure that the refrigerant hoses are in flawless condition.

Observe the system's maximum permitted operating pressure.



Do not switch on the testo Smart Valve until all hoses have been attached and the installation is ready for charging.



Protect the testo Smart Valve from vibrations. Otherwise, safe opening and closing cannot be guaranteed.

If the testo Smart Valve is subjected to a hard impact or a fall, it must be switched on and off again. Otherwise, the valve position may be lost.

✓ All connections must be pressureless (ambient pressure).

1 Place refrigerant bottle on scale.



Make sure that there is always enough refrigerant in the bottle so that the charging process can be carried out correctly.

2 Connect refrigerant bottle to valve.

3.1 From the valve, connect the yellow refrigerant hose to the low pressure side (blue) of the manifold and connect the low pressure side (blue) and high pressure side (red) of the manifold to the system.



Pay attention to the refrigerant flow direction. This is indicated by an arrow on the valve.

3.2 When using the app, connect the valve directly to the system with refrigerant hoses, without the manifold.

8.4 Manual charging via weight

This function enables a refrigerant circuit to be charged manually via weight using the **testo 560i** in combination with the app or **testo 550s / testo 557s** manifold.

By manually opening and closing the valve, the system is charged with refrigerant until the target value (weight/superheating/subcooling) is reached.



When using the manifold, the app is in second-screen mode. All settings must be made on the manifold.



Before each charge, make sure that the refrigerant hoses are in flawless condition.



The system must be supervised by a competent person throughout the entire process.

✓ **testo 560i** is connected via Bluetooth to the **testo Smart App** or the **testo 550s / testo 557s** manifold.

✓ **testo 560i** is integrated into the refrigerant circuit.

1 Select the required refrigerant on the manifold/app and press **[Menu/Enter]** to confirm.

1.1 If necessary, zero sensor on manifold/app [P = 0].

2 Open valve(s) manually and add refrigerant to the system until the required value is reached.

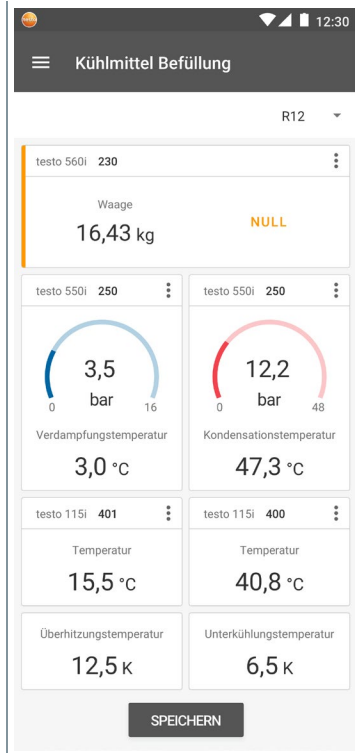

▶ Added refrigerant is displayed in g/kg increments on the manifold/app.

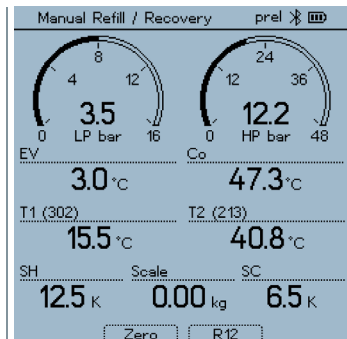

8.5 Automatic charging by target weight

This function enables the system to be charged automatically with an input target weight using the **testo 560i** scale and the **testo Smart Valve** in combination with the app or the **testo 550s / testo 557s** manifold.



The appropriate maximum charge value for a system must be entered in the **[Max charge]** field on the manifold/app.



When using the manifold, the app is in second-screen mode. All settings must be made on the manifold.



Before each measurement, check that the refrigerant hoses are in flawless condition.



The system must be supervised by a competent person throughout the entire process.

-
- ✓ testo 560i and testo Smart Valve are connected via Bluetooth to the testo Smart App or the testo 550s / testo 557s manifold.
 - ✓ testo 560i and testo Smart Valve are integrated into the refrigerant circuit.
 - 1 Select the required refrigerant on the manifold/app and press **[Menu/Enter]** to confirm.
 - 1.1 If necessary, zero sensor on manifold/app [P = 0].

- 2 In the app, set the required weight to be supplied to the system and use the [▼] button to start the process.

▶ The valve opens and attempts to fill with the set charge quantity.

No pulsating charging takes place.

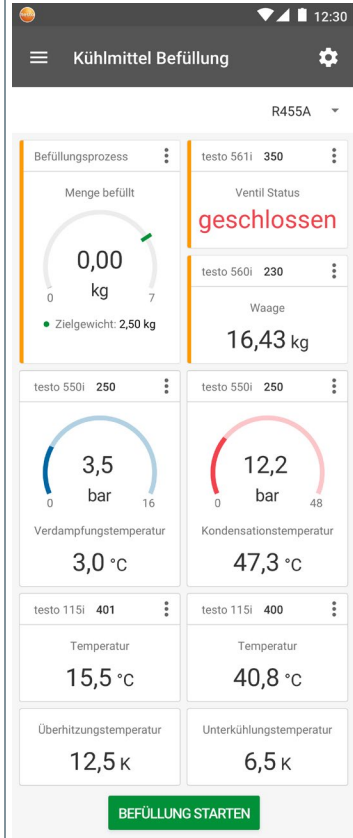

- ▶ Added refrigerant is displayed in g/kg increments on the manifold/app.

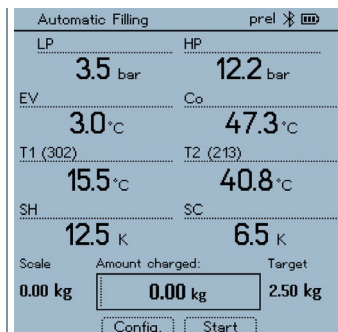

- 3 Once charging is finished, the process can be repeated [New] or another mode for charging [Optimize] can be selected.

8.6 Automatic charging by target superheat

This function enables a refrigerant circuit to be charged via the target superheat value using the **testo 560i** scale and the **testo Smart Valve** in combination with the app or **testo 550s / testo 557s** manifold.

For this, the current superheating value is determined. Based on this information, a target superheat value can be entered. The system is filled automatically until the target value is reached.



The appropriate target superheat value for a system must be entered on the manifold/app.



When using the manifold, the app is in second-screen mode. All settings must be made on the manifold.



Before each measurement, check that the refrigerant hoses are in flawless condition.



The system must be supervised by a competent person throughout the entire process.

-
- ✓ testo 560i and testo Smart Valve are connected via Bluetooth to the testo Smart App or the testo 550s / testo 557s manifold.
 - ✓ testo 560i and testo Smart Valve are integrated into the refrigerant circuit.
 - 1 Select the required refrigerant on the manifold/app and press **[Menu/Enter]** to confirm.
 - 1.1 If necessary, zero sensor on manifold/app [P = 0].

- 2 Set the required target superheat value to be reached on the manifold/app and use the [▼] button to start the process.

- ▶ The valve opens and attempts to reach the set superheat by charging refrigerant.

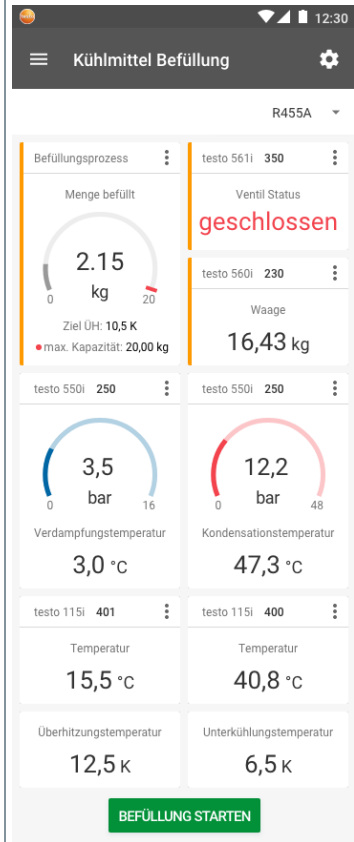

- ▶ Added refrigerant is displayed in g/kg increments on the manifold/app.

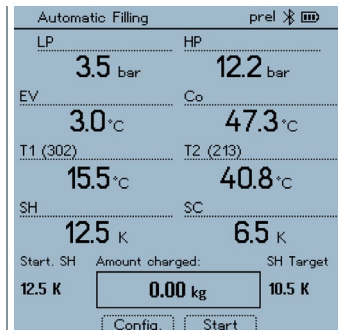

8.7 Automatic charging by target subcooling

This function enables a refrigerant circuit to be charged via the target subcooling value using the **testo 560i** scale and the **testo Smart Valve** in combination with the app or **testo 550s / testo 557s** manifold.

For this, the current subcooling value is determined. Based on this information, a target subcooling value can be entered. The system is filled automatically until the target value is reached.



The appropriate target subcooling value for a system must be entered on the manifold/app.



When using the manifold, the app is in second-screen mode. All settings must be made on the manifold.



Before each measurement, check that the refrigerant hoses are in flawless condition.



The system must be supervised by a competent person throughout the entire process.

-
- ✓ testo 560i and testo Smart Valve are connected via Bluetooth to the testo Smart App or the testo 550s / testo 557s manifold.
 - ✓ testo 560i and testo Smart Valve are integrated into the refrigerant circuit.
 - 1 Select the required refrigerant on the manifold/app and press **[Menu/Enter]** to confirm.
 - 1.1 If necessary, zero sensor on manifold/app [P = 0].

- Set the required target subcooling value to be reached on the manifold/app and use the [▼] button to start the process.

- The valve opens and attempts to reach the set subcooling by charging refrigerant.

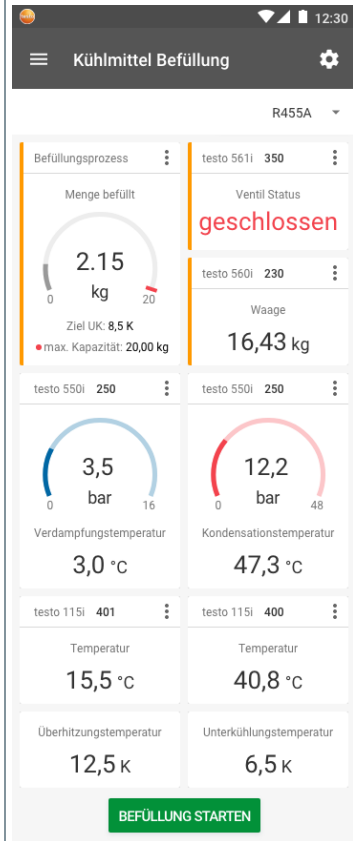

- Added refrigerant is displayed in g/kg increments on the manifold/app.

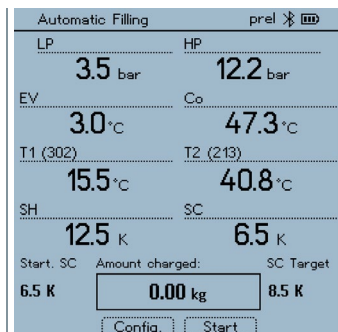

8.8 Automatic charging via target superheat

This function enables a refrigerant circuit to be charged via the target superheat using the **testo 560i** scale and the **testo Smart Valve** in combination with the app or the **testo 550s / testo 557s** manifold.

For this, two testo 605i Smart Probes are connected to the manifold or the testo Smart App. Based on this information, the optimum target superheat can be calculated live. The system is filled automatically until the target value is reached.



The appropriate target superheat value for a system must be entered on the manifold/app.



When using the manifold, the app is in second-screen mode. All settings must be made on the manifold.



Before each measurement, check that the refrigerant hoses are in flawless condition.



The system must be supervised by a competent person throughout the entire process.

-
- ✓ | testo 560i and testo Smart Valve are connected via Bluetooth to the testo Smart App or the testo 550s / testo 557s manifold.
 - ✓ | testo 560i and testo Smart Valve are integrated into the refrigerant circuit.
 - 1 | Select the required refrigerant on the manifold/app and press **[Menu/Enter]** to confirm.
 - 1.1 | If necessary, zero sensor on manifold/app [P = 0].

- 2 Set the required target superheat value to be reached on the manifold/app and use the [▼] button to start the process.

▶ Refrigerant is automatically supplied to the system until the set value is reached.

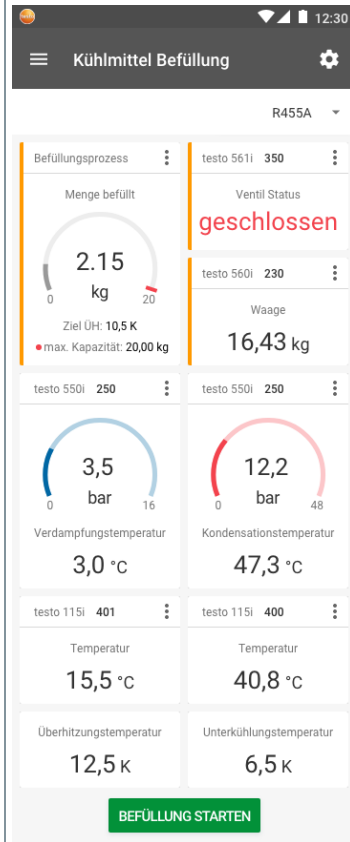

- ▶ Added refrigerant is displayed in g/kg increments on the manifold/app.

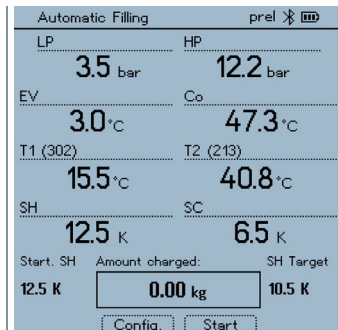

9 Maintenance

9.1 Calibration



The **testo 560i** scale and the **testo Smart Valve** are supplied with a factory calibration certificate as standard.

Recalibration once every 12 months is recommended in many applications.

This can be carried out by Testo Industrial Services (TIS) or other certified service providers.

Please contact testo for further information.

9.2 Cleaning instruments



Do not use any aggressive cleaning agents or solvents! Mild household cleaning agents and soap suds may be used.

- > If the instrument housing is dirty, clean it with a damp cloth.

9.3 Keeping connections clean

- > Keep screw connections clean and free of grease and other deposits; clean with a damp cloth as required.

9.4 Removing oil residues

- > Carefully blow out oil residues in the valve block using compressed air.

9.5 Ensuring measuring accuracy

Testo Customer Service will be happy to help you as required.

- > Check the instrument regularly for leaks. Keep to the permissible pressure range!
- > Calibrate the instrument regularly (recommendation: once a year).

9.6 Changing batteries/rechargeable batteries

Changing batteries/rechargeable batteries in the testo 560i scale

- ✓ The instrument is switched off.
- 1 Open battery compartment.
- 2 Remove spent batteries/rechargeable batteries and insert new ones (4 x 1.5V, type AA / Mignon / LR6) into the battery compartment. Observe the polarity!
- 3 Close the battery compartment.
- ▶ After inserting the batteries, the instrument switches on automatically and is in Bluetooth® connection mode.



In Bluetooth® connection mode, connection can be established to the **testo Smart App** or to a **testo 550s** or **testo 557s** manifold.



Do not change or remove batteries during operation, otherwise the charging process will be interrupted.



When not in use for a long period: Take out the (rechargeable) batteries.

Changing the batteries/rechargeable batteries in the testo Smart Valve

- ✓ The instrument is switched off.
- 1 Unfold the suspension hook and open the battery compartment (clip lock).
- 2 Remove the spent battery/rechargeable battery and insert a new one (1 x 9.0V (6LR61) block battery) into the battery compartment. Observe the polarity!
- 3 Close the battery compartment.
- ▶ After inserting the batteries, the instrument switches on automatically and is in Bluetooth® connection mode.



In Bluetooth® connection mode, connection can be established to the **testo Smart App** or to a **testo 550s** or **testo 557s** manifold.



Do not change or remove batteries during operation, otherwise the charging process will be interrupted.



When not in use for a long period: Take out the (rechargeable) batteries.

10 Technical data

10.1 Technical data for testo 560i

Feature	Value
Connection to the sensor	BLE 4.2+
Interface	BLE 4.2+
Power supply	Power source: Rechargeable batteries / batteries 4 x 1.5 V type AA / Mignon / LR6 Battery life: > 70 h at 25 °C
IP class	44
Weight	4.01 kg (with batteries, with bag) 3.11 kg (with batteries, without bag)
Dimensions	Approx. 310 x 287 x 58 mm
Ambient conditions	Operating temperature: -10 to 50 °C / 14 to 122 °F Storage temperature: -10 to 50 °C / 14 to 122 °F
Measuring range	0.00 to 100.00 kg
Accuracy (nominal temperature 22 °C/71.6 °F)	(After zeroing) Operating temperature 25 ± 5 °C (inclination angle around 0°): ≤ ± (10 g + 0.03 %RH) (0~30 kg) ≤ ± (10 g + 0.05 %RH) (30~100 kg) Other operating temperature (inclination angle around 0°): ≤ ± (20 g) (0~10 kg) ≤ ± (10 g + 0.15 %RH) (10~100 kg)
Solution	0.01 kg
Bluetooth range	≥ 30 m in all directions in an open area

10.2 Technical data for testo Smart Valve

Feature	Value
Connection to the sensor	BLE 4.2+
Interface	BLE 4.2+
Power supply	Power source: Rechargeable batteries / batteries 9.0 V, type 6LR61 Battery life: > 60 h at 3000 valve actuations
IP class	54
Weight	0.57kg (with battery)
Dimensions	Approx. 95 x 119 x 47 mm
Ambient conditions	Operating temperature: -10 to 50 °C / 14 to 122 °F Storage temperature: -10 to 50 °C / 14 to 122 °F
Bluetooth range	≥ 50 m in all directions in an open area
Max. permitted operating pressure	35 bar

11 Tips and assistance

11.1 Accessories

Description	Order no.
Magnetic strap for valve	0564 1001

For a complete list of all accessories and spare parts, please refer to the product catalogues and brochures or visit our website www.testo.com

12 Support

You can find up-to-date information on products, downloads and links to contact addresses for support queries on the Testo website at: www.testo.com.

If you have any questions please contact your local dealer or the Testo Customer Service. You can find contact details on the back of this document or online at www.testo.com/service-contact.



People • Technology • Solutions

HEAD OFFICE : AUCKLAND Tel : (09) 579 1990
WELLINGTON : Tel : (04) 499 3591 CHRISTCHURCH : Tel : (03) 366 0017
Email : sales@eurotec.co.nz WEBSITE : www.eurotec.co.nz

HVAC • Refrigeration • Electrical • Measurement

0970 5610 en 01 – 04.2022