

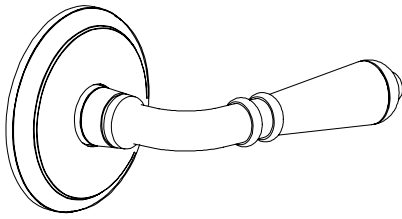

WARNING: This product can expose you to chemicals including lead, which is known to the state of California to cause cancer and birth defects or other reproductive harm. For more information go to www.P65Warnings.ca.gov.



Installation Guide - Passage/ Privacy - Knob or Lever
Guía de Instalación - De Paso / Privacidad - Perilla o Manija
Guide d'installation - Passage / Intimité - Bouton ou béquille

1. Door Prep

Preparación de la puerta
Préparation de la porte

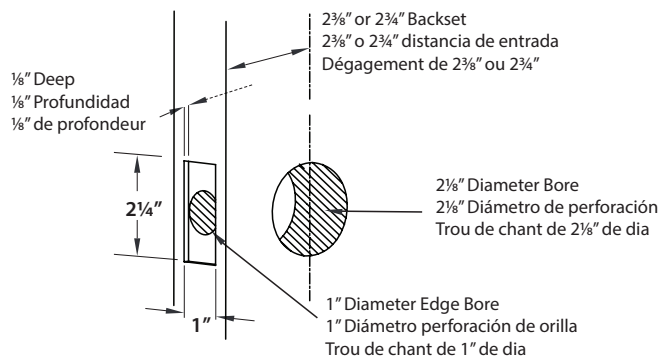

2. Standard Strike Plate Door Jamb Prep

Placa de pestillo estándar para jamba de puerta
Prep pour jambage de porte à gâche standard

Door Thickness (A)
Espesor de la puerta (A)
Épaisseur de porte (A)

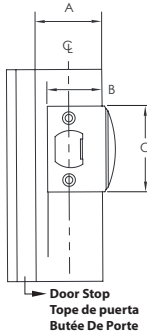

A	B	C
1 3/8"	1 1/4"	2 1/4"
1 1/2"	1 5/8"	2 1/4"
1 3/4"	1 7/16"	2 1/4"

NOTE: Dimensions B & C should be used as reference only. Due to tolerances actual door jamb prep dimensions will vary. Using the strike plate outline edges and locate screw holes on strike with center line on jamb.

NOTA: Las dimensiones B y C deben utilizarse solamente como referencia. Debido a las tolerancias, las dimensiones reales de la placa de pestillo para jamba de puerta variarán. Use los bordes de la placa de pestillo para localizar los orificios de los tornillos y alinear con la línea central de la jamba.

REMARQUE: Les dimensions B et C n'ont qu'une valeur indicative. Compte tenu des tolérances, les dimensions de la prep de jambage de porte réelles peuvent varier. Définissez les contours à l'aide de la gâche et localisez les trous de vis sur la gâche avec la ligne centrale sur le jambage.

3. Install Strike Plate

Instalar Contra
Instalar la gâche

Fasten Strike Plate with #8 wood screws (provided).

Fijar la contra con los tornillos #8 para madera (incluidos).

Fixer la gâche à l'aide des vis à bois n°8 (fournies).

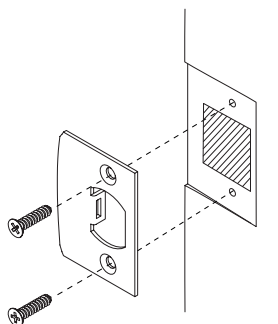

4. Place Plastic Alignment Tool in Bore Hole & Install Latch

Coloque la herramienta de alineación de plástico en el orificio & Instalar picaporte
Mettre l'outil d'alignement en plastique dans le trou & Installer le pêne

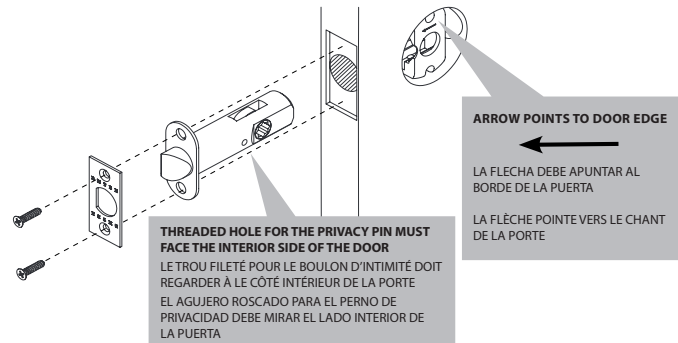

5. Install Outside and Inside Trims

Instalación de unidades externa e interna
Installer les garnitures intérieures et extérieure

1 Position the outside trim through the bore hole.

Coloque la unidad externa através del orificio perforado.

Placer la garniture extérieure dans le trou.

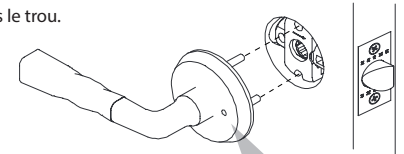

MAKE SURE THE RELEASE HOLES LINE UP WITH THE PRIVACY PIN
ASEGÚRESE QUE EL ORIFICIO DE LIBERACIÓN ESTE ALINEADO CON EL PIN DE PRIVACIDAD
S'ASSURER QUE LES TROUS DE DÉGAGEMENT S'ALIGNE SUR LA TIGE D'INTIMITÉ

2 Fasten Inside Trim using two #8 machine screws (provided), and install Privacy Pin.

Fije la unidad interna usando dos tornillos #8 (incluidos), e instale el pin de privacidad.

Fixer la garniture intérieure à l'aide des deux vis à métal (fournies) et installer la tige d'intimité.

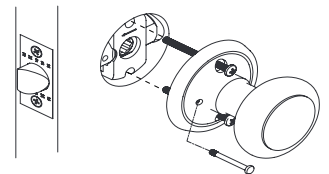

Dummy Installation

Instalación de la función Dummy
Installation du faux ensemble

1 Align Mounting Plate

Aligner la Plaque de Montage
Alinear la Placa de Montaje

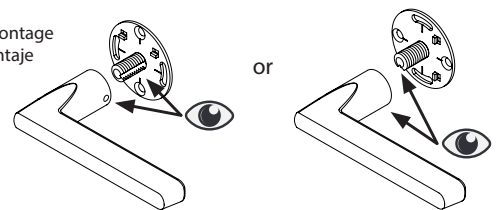

2 Install Mounting Plate & Adjust for Level

Instalar la Plaque de Montaje y Ajustar au Niveau

Instalar la Placa de Montaje y Ajustar al Nivel

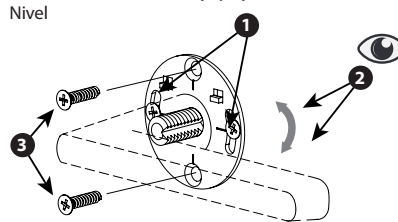

3 Assemble Lever/Knob & Rosette

Montar el Levier/Poignée y la Rosetón
Montar la Palanca/Perilla y el Rosetón

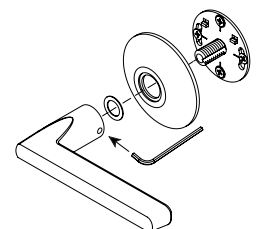

CF Mechanism

Passage & Privacy Locksets

Installation Guide

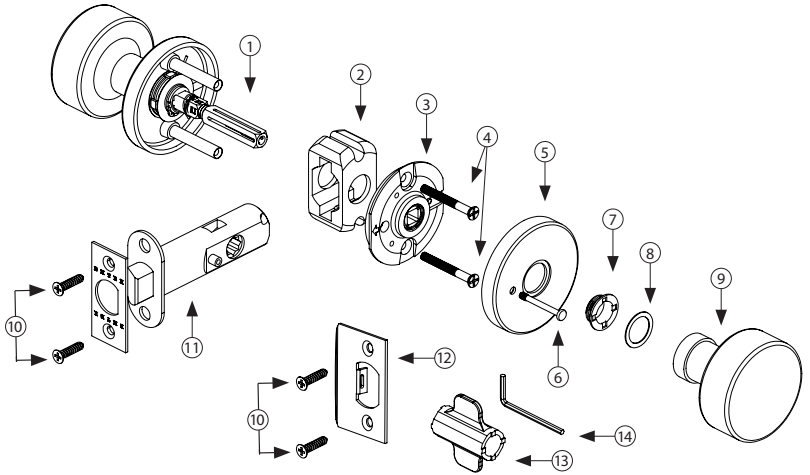

What's in the Box

ITEM	DESCRIPTION	QTY
1	Pre-Assembled Trim	1
2	Plastic Alignment Tool	1
3	Concealed Fastener Mechanism	1
4	#8-32 x 1" Flat Head Machine Screws	2
5	Rosette	1
6	Privacy Pin (For Privacy Lock Only)	1
7	Ring Fastener	1
8	Plastic Washer	1
9	Knob or Lever	1
10	#8 x 3/4" Wood Screws	4
11	Latch	1
12	Strike Plate	1
13	Ring Fastener Wrench	1
14	3/32" Allen Wrench	1

Download the **BILT** App
for EMTEK Interactive installation



BILT®



1. Door Prep

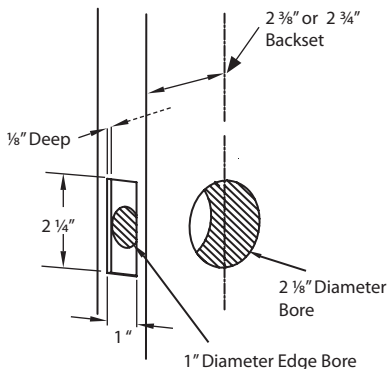

4. Install Latch

Step 1: Place Plastic Alignment tool in bore hole.

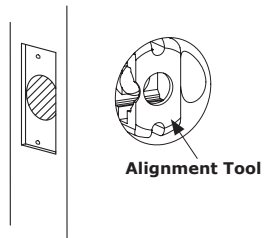

2. Standard Strike Plate Door Jamb Prep

Door Thickness (A)

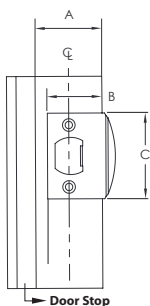

A	B	C
1 3/8"	1 1/4"	2 1/4"
1 1/2"	1 5/16"	2 1/4"
1 3/4"	1 7/16"	2 1/4"

NOTE: Dimensions B & C should be used as reference only. Due to tolerances actual door jamb prep dimensions will vary. Using the strike plate outline edges and locate screw holes on strike with center line on jamb.

Step 2: Insert the latch through the alignment tool.

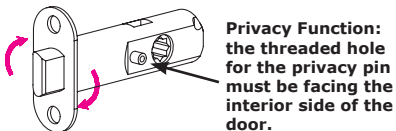

Privacy Function: the threaded hole for the privacy pin must be facing the interior side of the door.

! ROTATE THE NOSE BOLT SO THAT THE CURVED FACE WILL HIT THE STRIKE PLATE WHEN CLOSING THE DOOR.

3. Install Strike Plate

Fasten Strike Plate using two #8 x 3/4" wood screws.

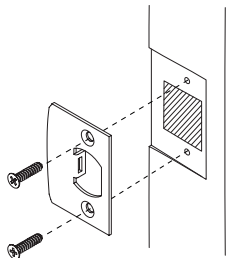

Step 3: Fasten Latch using two #8 x 3/4" wood screws.

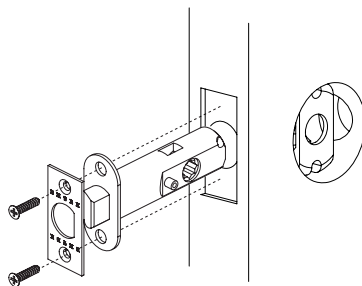

5. Install Inside Trim

Lever sets are universal and can be flipped for right or left handed doors.

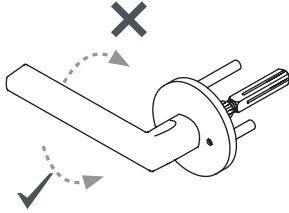

Step 1: Mount Pre-Assembled Trim, with the spindle entering the center of the plastic alignment tool.

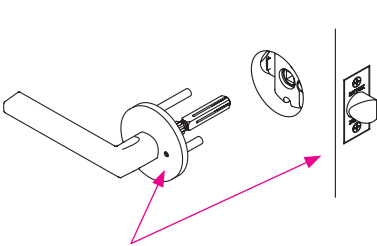

! If this handle set has a privacy function, ensure that the release hole is on the side closest to the edge of the door.

Step 2: Place the CF Mechanism with the arrow pointing to the door edge. Fasten it with (2) machine screws. Check the trim alignment before fully tightening the screws.

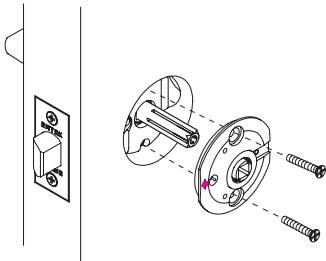

! Ensure the hole in the CF Mechanism aligns with the privacy pin hole in the Latch.

Step 3: Fully extend the spindle by pulling it outwards to ensure it is against the internal stop.

! It's important to check if the spindle is fully engaged with the latch. Rotate the lever or knob until the spindle is retracting the latch. Pull the spindle again if necessary.

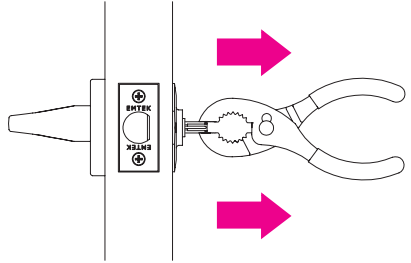

Step 4: After the spindle has been fully extended, tighten the Pre-installed set screw in the lever or knob with the provided Allen wrench. Ensure that it is firmly tightened.

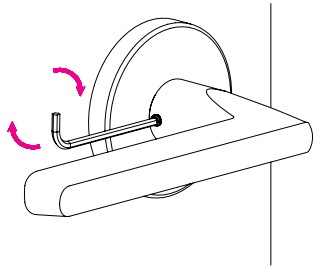

Step 5: Insert the short end of Allen wrench into the spindle and ensure that it is securely tightened.

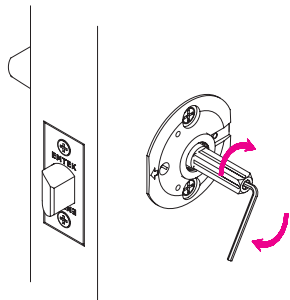

6. Place the Outside Trim

Step 1: Place the rosette.

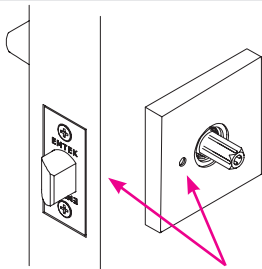

! In the privacy function, ensure the privacy pin hole in the rosette is on the side closest to the door edge and aligns with the hole in the CF Mechanism.

Step 2: Secure the rosette to the door using the Ring Fastener Wrench.

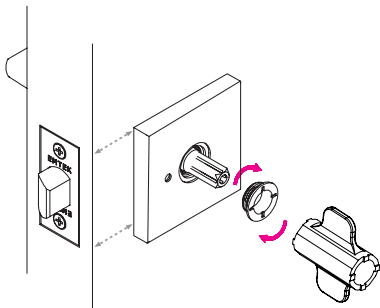

Step 3: Place the Plastic Washer on the door lever or knob.

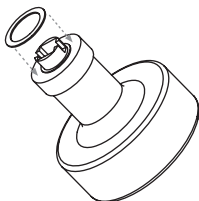

Step 4: Slide the door lever or knob onto the spindle. Make sure the plastic washer remains centered on the stem as you slide the lever or knob onto the spindle and up against the rosette.

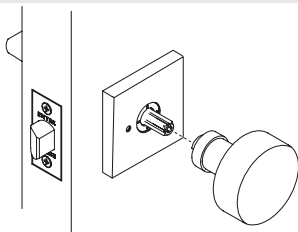

Step 5: Firmly tighten the Pre-installed set screw in the lever or knob with the provided Allen wrench. Ensure that it is firmly tightened.

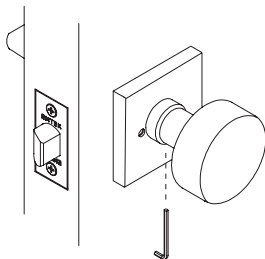

Step 6: For Privacy Lock, screw the Privacy Pin through the rosette, into the latch. To check functionality, turn the interior lever/knob to engage the latch. Now, push the privacy pin in and turn the exterior lever/knob. The exterior lever/knob should not retract the latch.

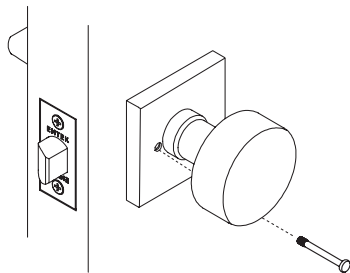

! For emergency, insert a nail type object into the release hole of the exterior rosette to open the lock.

! **WARNING:** This product can expose you to chemicals including lead, which is known to the state of California to cause cancer and birth defects or other reproductive harm. For more information go to www.P65Warnings.ca.gov.