

Installation Guide - Tubular Monolithic Entry Set - Single Cylinder Deadbolts

1. Door Prep

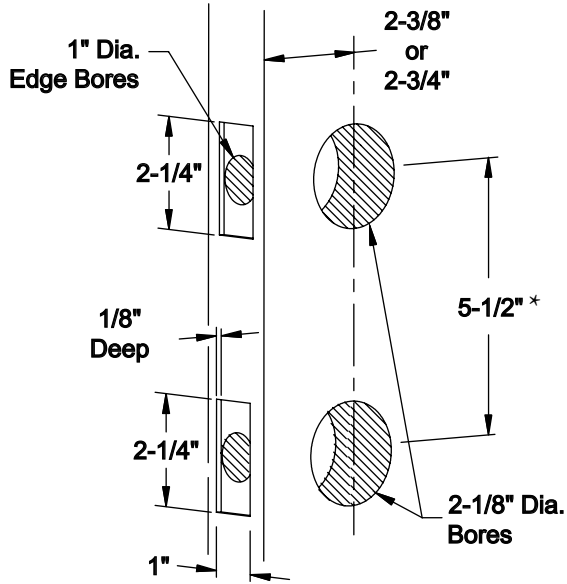

* Marretta 6 style locks have 6" center to center bore spacing.

2. Door Jamb Prep

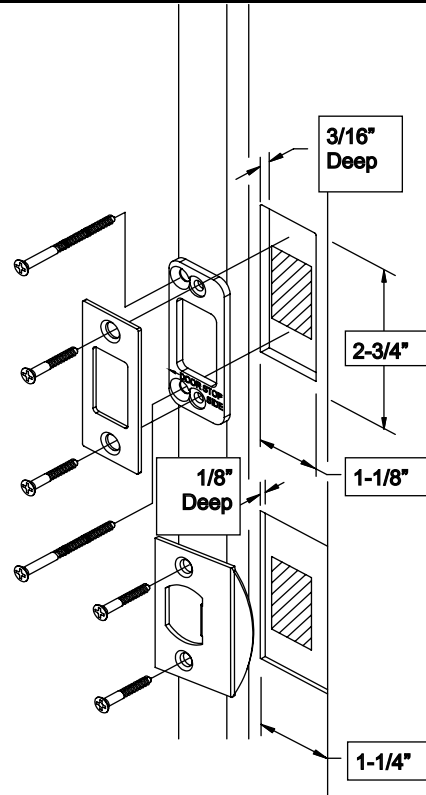

3. Outside Installation

Extension Collar is provided for thin doors.

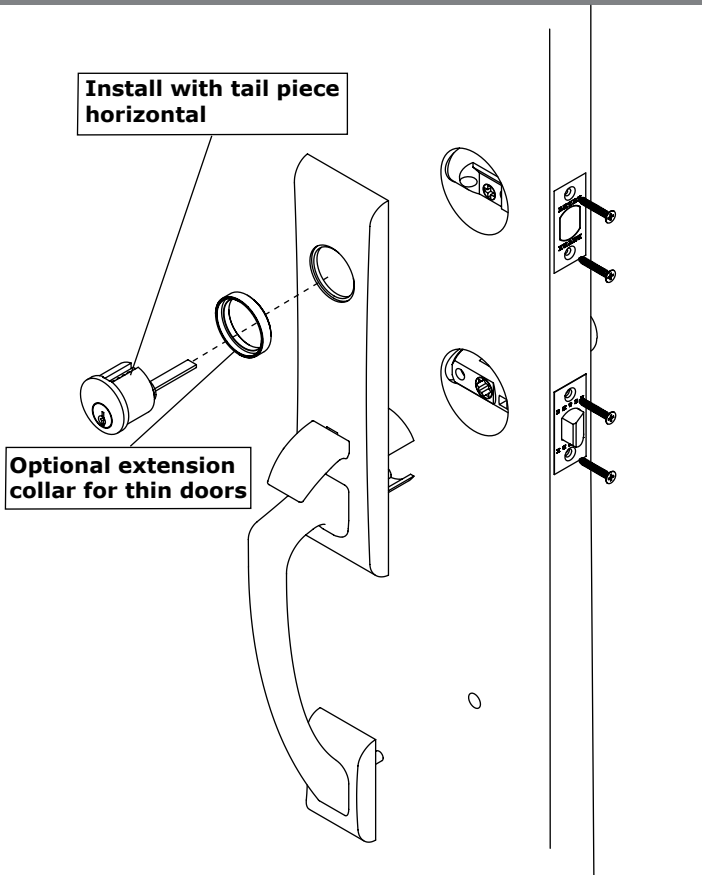

Plates and grips vary depending on style.

4. Inside Installation

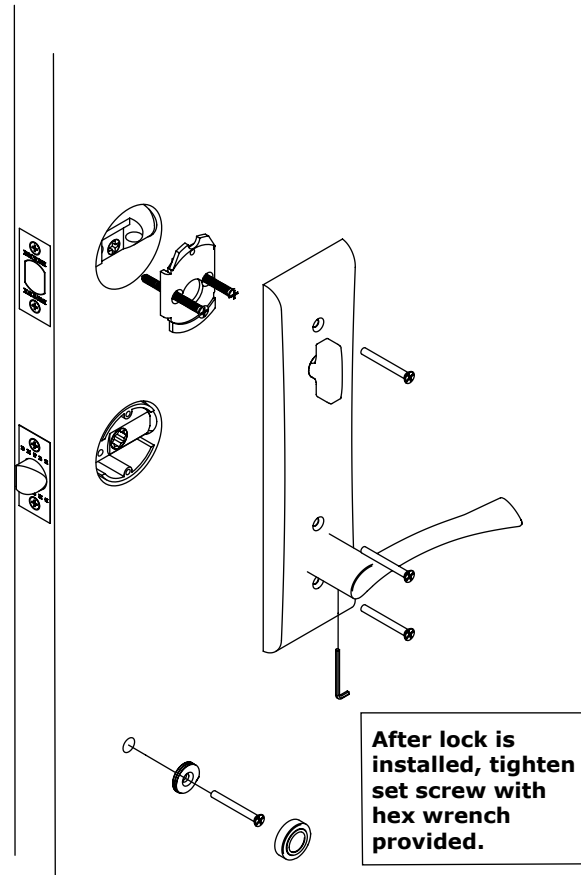

Installation Instructions-Tubular Monolithic Entry Set - Dummy

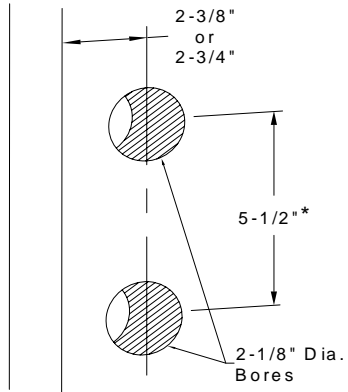

* Marietta 6 style locks have 6" center to center bore spacing.

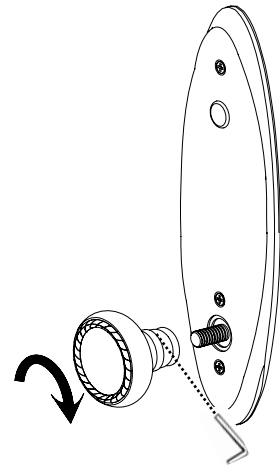
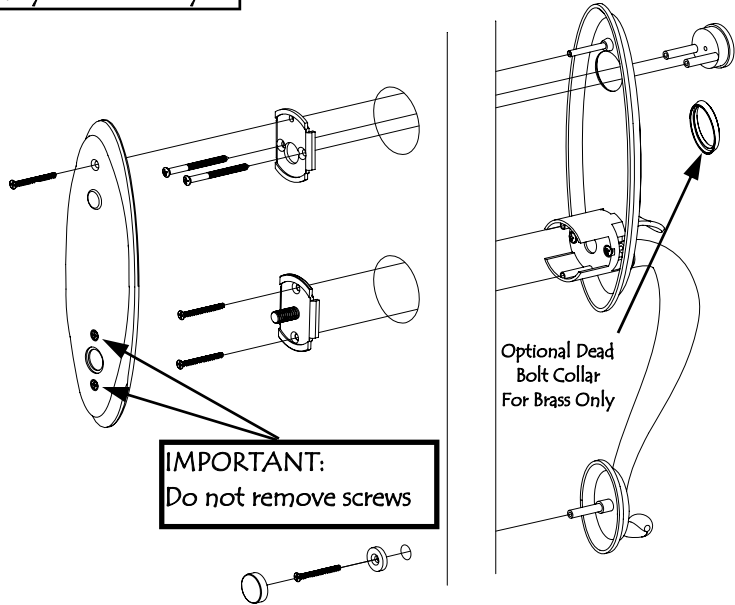

AFTER LOCK HAS BEEN INSTALLED
Tighten Set Screws with Allen Wrench

Installation Instructions-Tubular Sectional Entry Set - Dummy

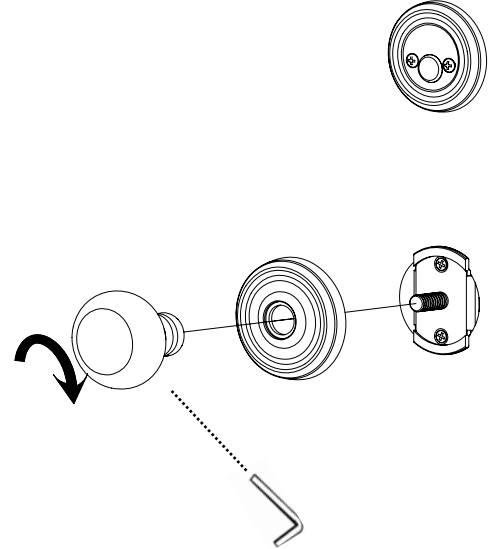
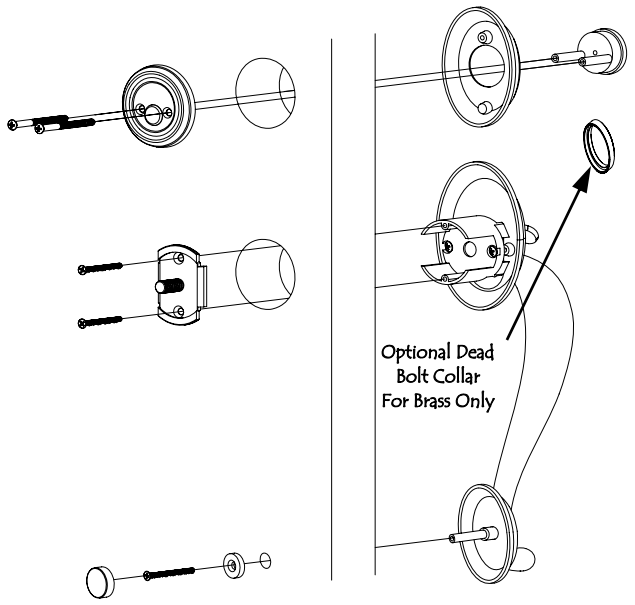
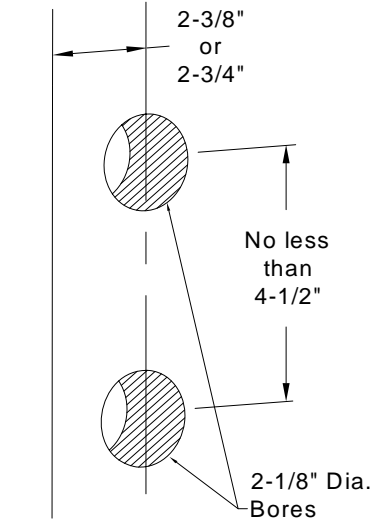

AFTER LOCK HAS BEEN INSTALLED
Tighten Set Screws with Allen Wrench