

REQUIRED TOOLS:

Electric Drill

1/2" Drill Bit

Phillips Head Screwdriver

INCLUDED HARDWARE:



#10-24 x 1.75" Machine Screw (x2)

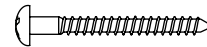

#8 x 1.75" Wood Screw (x2)

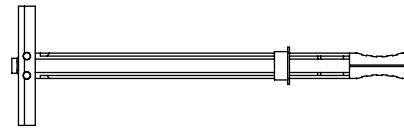

Zip Toggle (x2)

Mounting Template (x1)

INSTALLATION INSTRUCTIONS

1. Hold Donna Sconce against wall in mounting location. With a pencil, mark top/center of Wall Canopy.

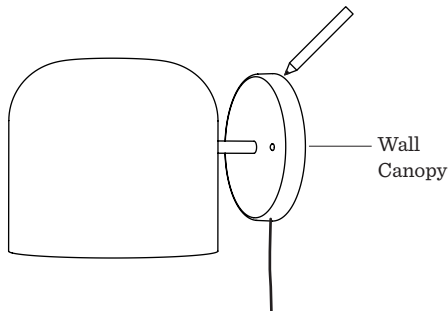

2. Align Point A on enclosed Mounting Template with pencil mark on wall. Attach Template securely to wall using low tack tape.
3. Determine wall substrate behind points B and C. For stud locations, proceed to Step 4. For non-stud locations, skip to Step 5.
4. For stud locations, drill through drywall and into stud at points B and C using 1/8" Drill Bit.

5. For non-stud locations, drill through drywall at points B and C using 1/2" Drill Bit. Remove Mounting Template and install Zip Toggles as follows.
6. Push Metal Wing end of Zip Toggle through drywall while holding Zipper end of Zip Toggle.

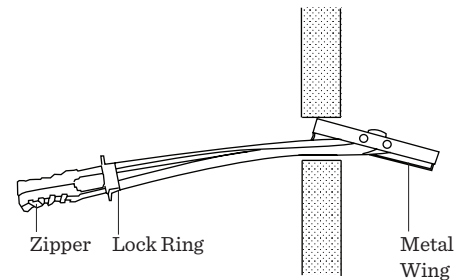

7. When Metal Wing flips back into the open position, push Lock Ring up tight against wall and separate Zipper halves. Zippers will break off against Lock Ring.

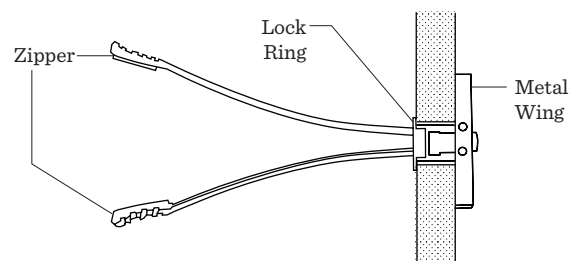

8. Thread Machine Screws into Lock Rings and/or Wood Screws into pre-drilled holes. Tighten with Phillips Head Screwdriver leaving screwheads 1/4" from wall.

.....
Non-stud Location

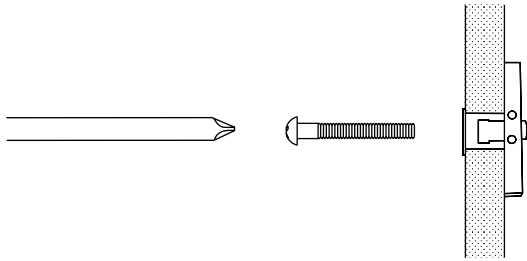

.....
Stud Location

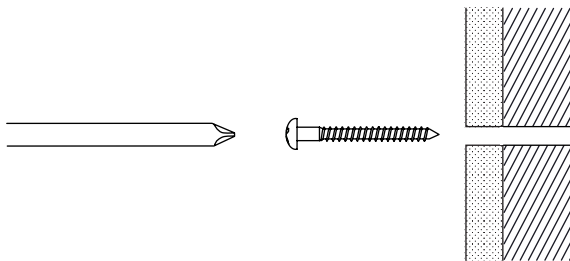

9. Align mounting bracket keyholes with Screws and slide Donna Sconce down to mount. If Sconce is loose, remove from wall and tighten Screws. Install Sconce again to check fit. Repeat as necessary.

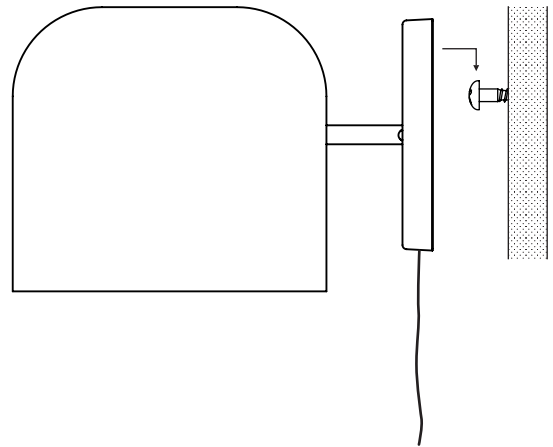

Donna Plug-In Scone

MOUNTING TEMPLATE

