

# Systems Protector

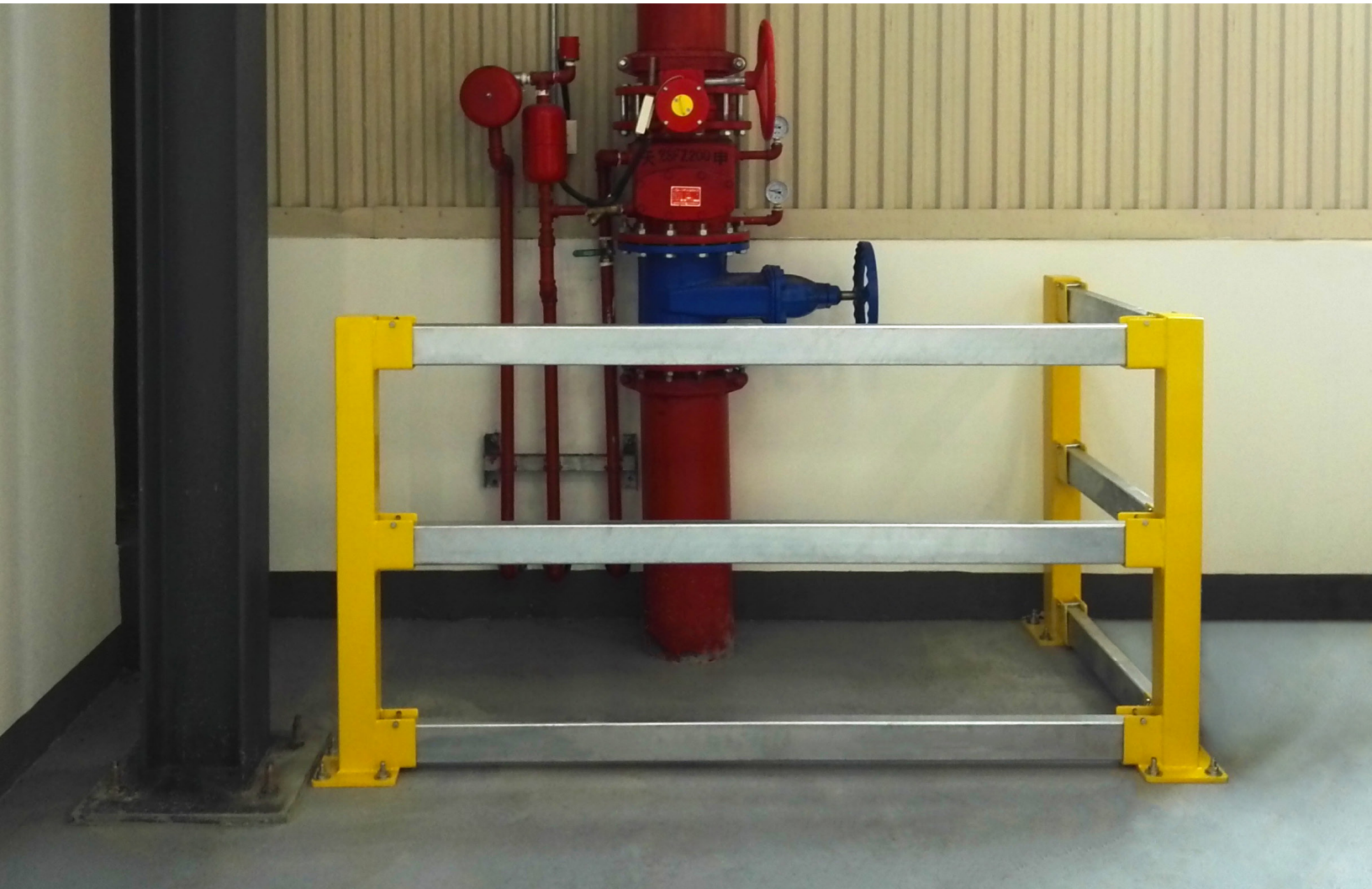

## Protects essential systems while maintaining accessibility.

Are you tired of runaway pallets, stock carts and forklifts banging up the electrical, plumbing, refrigeration and information systems that are critical to keeping your business running? CartStop Systems Protector provides reliable protection from damaging blows, saving you money on costly repairs, while allowing full access to your systems when needed.

**Tough** Heavy-duty steel construction with safety yellow powder coat finish is impact resistant to warehouse equipment

**Shock Absorbing** Steel cross members safely protect critical systems, yet can be easily removed to allow access for maintenance and service

**Speedy Install** Self-threading concrete anchors eliminate the need for messy adhesives or quick-set cement

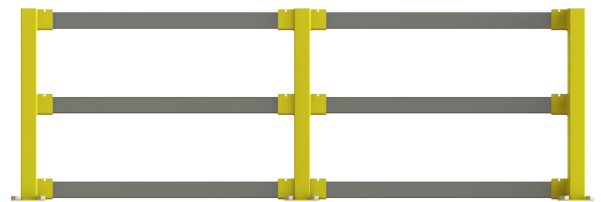

# Systems Protector

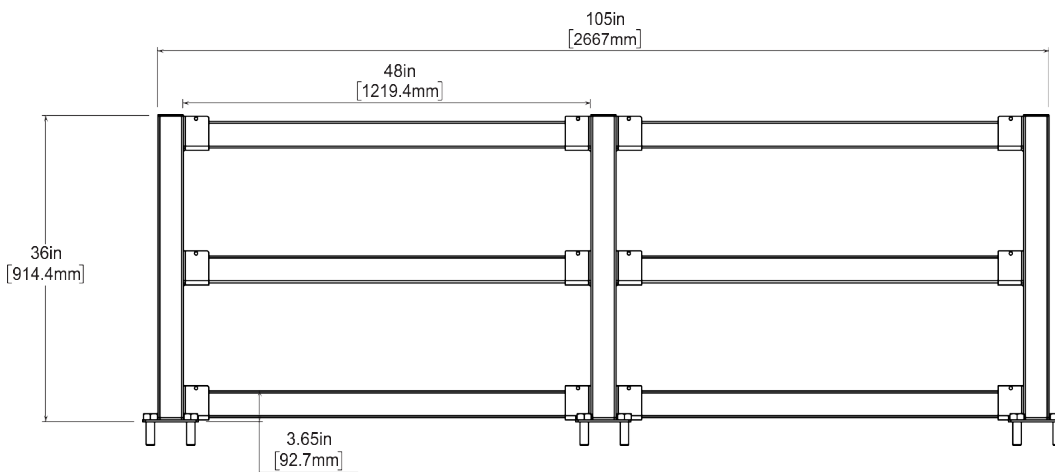
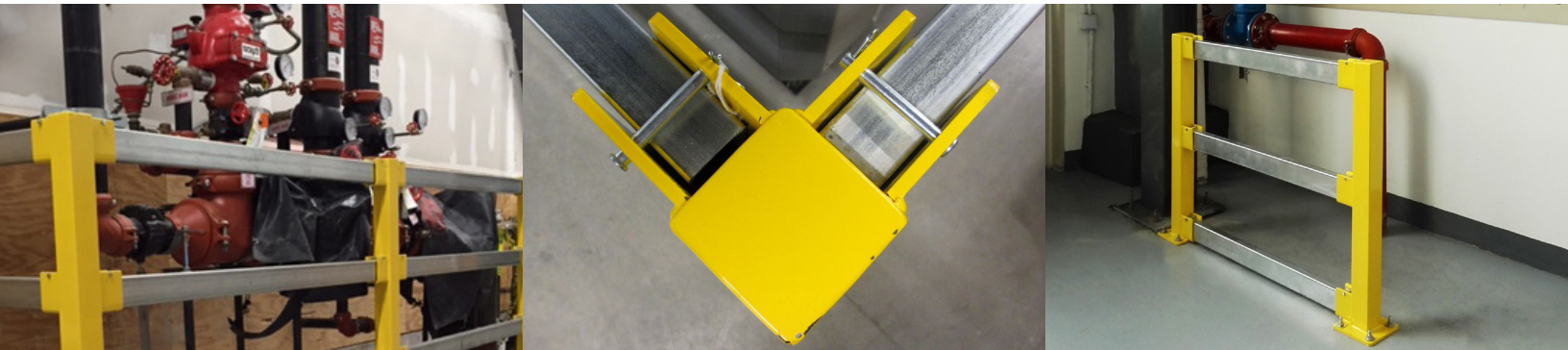

**Steel cross members safely protect critical systems, yet easily removed to allow access for maintenance**



## 36" Uprights Components:

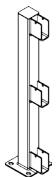

### End

Hardware included—all uprights ship with concrete anchors

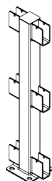

### Middle

Hardware included—all uprights ship with concrete anchors

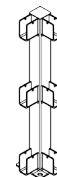

### Corner

Hardware included—all uprights ship with concrete anchors

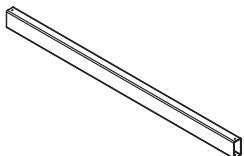

### Box Rail 8' Length

Electroplated Cold Rolled Steel



### 5/8 inch Concrete Anchor

3 inches long, self threading, & with anti-rotation serrations to prevent back-out

Red Head 5/8" x 3" LDT

**Safety Yellow**

Standard Colors – 2 week lead for quantity 1-10. Inquire for quantities 11 or more.



### McCue Corporation

Peabody, MA 01960, USA  
+1 (800) 800 8503  
customercare@mccue.com

### McCue UK & Europe

Milton Keynes, United Kingdom  
+44 (0)1908 365 511  
uksales@mccue.com

### McCue Asia

迈客(厦门)有限公司  
Xiamen, Fujian, China  
+86-592-2200790

[mccue.com](http://mccue.com)

