

S-LOCK MOUNTING

Patent: US D918,323 S

Slide the bottom of the light into any S-LOCK mount until the clip 'clicks' into place. Ensure it's secure before riding.

To remove, press down on the front lever to disengage S-LOCK, then slide the light away from the mount.



Far Focus Lens

- + Focuses light for maximum throw distance
- + 180° lens wrap to increase visibility from both sides.
- + Battery level colors
Green > 75%
Orange = 25% - 75%
Red < 25%

S-LOCK™

Charging Port

- + Lift waterproof cover to access USB-C charging port.

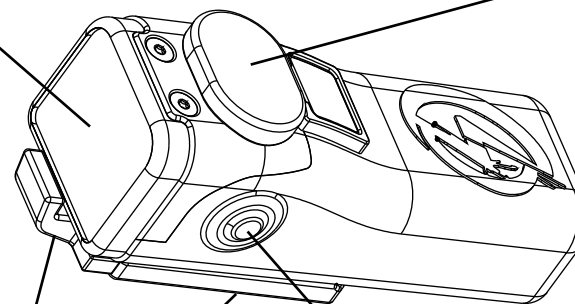

Dual Side Buttons

- + Press and hold for 1s to power on/off
- + Switch between light modes
- + Hold for 5s to enable pairing mode

WARNING

- 1) Riding at night can be more dangerous than during the day. Use extra caution and ride within your limits. Always wear a helmet and other protective gear to help avoid serious injury or death.
- 2) Avoid using this light in full power when riding towards oncoming cars and/or pedestrians. Use caution when operating at full power to avoid temporarily blinding yourself or others.

Light Specs

SIZE	25 x 75 x 25 (mm)
WEIGHT	50 grams
BATTERY	1000 mAh
WATER RATING	IPX7 Waterproof (submersible up to 1 meter for 30 minutes)
CHARGE TIME	2 hours
LED	5700K / RED

SL-300+

	LIGHT MODE	LUMENS	BATTERY
1	LOW	50	12h
2	MEDIUM	150	4h
3	HIGH	300	2h
4	SLOW FLASH	150	20h
5	FAST FLASH	150	10h
6	BURST FLASH	150	20h

SL-R1+

	LIGHT MODE	LUMENS	BATTERY
1	LOW	10	22h
2	MEDIUM	20	12h
3	HIGH	40	6h
4	SLOW FLASH	20	60h+
5	FAST FLASH	20	40h
6	BURST FLASH	20	60h+

1 YEAR WARRANTY

ShredLights include a 1 year warranty covering manufacturing defects, failures with S-LOCK, and electronic failures such as inability to charge or operate properly.

For any issues with your lights, visit [ShredLights.com/Warranty](https://www.shredlights.com/warranty)



WWW.SHREDLIGHTS.COM



@ShredLights | #ShredLights



ShredLights

Download the App for **Faster Setup & Full Control** over Lights and Groups.

How to Pair Lights into Groups Without the App

(App is recommended for first pairing out of the box)

1 Enable Pairing Mode

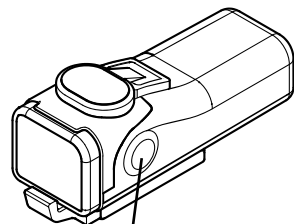

Press and hold the side button for 5 seconds

Light will flash at 10% brightness when pairing mode is enabled.

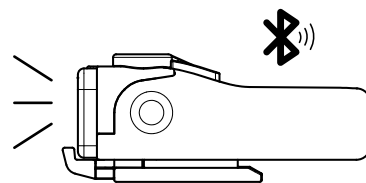

2 Pair 2 Lights to Create a Group

Enable pairing mode on Light 1

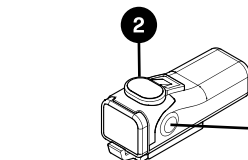
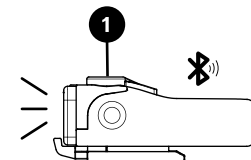

Press the side button on Light 2 for 1 second

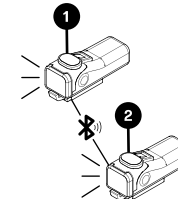

Both lights will turn on to indicate successful pairing.

Group 1

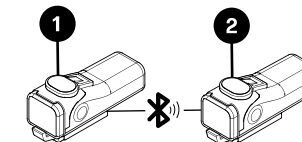

Lights 1 & 2 can now be controlled together as Group 1.

Bluetooth Control

Bluetooth is always on and ready to communicate with the app or other lights in the group.

Control Full Groups With One Button

- + Use any light in the group to turn the group on/off (hold 1s) and change group light modes (press)
- + Use the app to customize group light modes and check the battery status of lights and groups
- + Lights remained paired to group after dying and being recharged

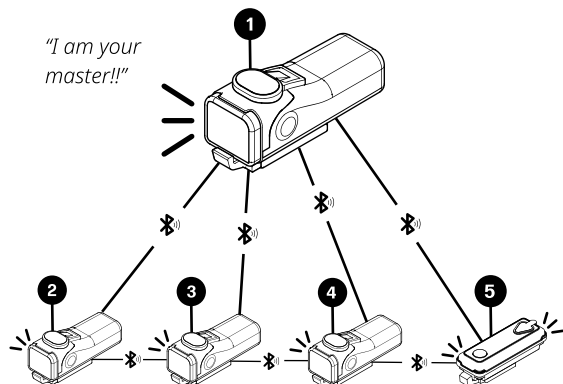

3 Add Lights to a Group

Enable pairing mode on Light 3

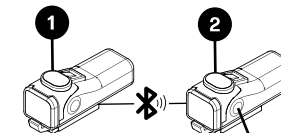
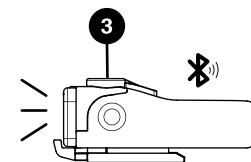

Press the side button on any light in Group 1 for 1 second

All 3 lights will turn on indicating Light 3 is paired to Group 1. Repeat this process to add lights to any group.

How to Remove Lights from a Group

1. Enable pairing mode on the light you want to remove
2. Press and hold the side button of a different light in the group