

Installation Guidelines

60 Hz Air-Cooled Generators

10 kW to 26 kW

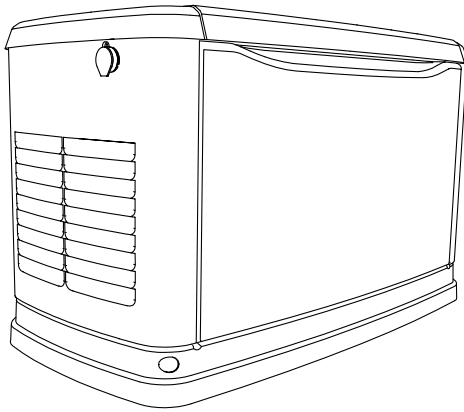

WARNING

Loss of life. This product is not intended to be used in a critical life support application. Failure to adhere to this warning could result in death or serious injury. (000209b)

Register your Generac product at:

WWW.GENERAC.COM

1-888-GENERAC

(888-436-3722)

Para español, visita: <http://www.generac.com/service-support/product-support-lookup>

Pour le français, visiter : <http://www.generac.com/service-support/product-support-lookup>

SAVE THIS MANUAL FOR FUTURE REFERENCE

Use this page to record important information about this generator.

Model:	
Serial:	
Production Date:	
Volts:	
LPV Amps:	
NG Amps:	
Hz:	
Phase:	
Controller P/N:	
STA MAC ID:	
SSID:	

Record the information found on the unit data label on this page. See **General Information** for the location of the unit data label. The unit has a label plate affixed to the inside partition, to the left of the control panel console as shown in **Figure 2-1**, **Figure 2-2**, or **Figure 2-3**. See **Operation** for directions on how to open the top lid and remove the front panel. Always supply the complete model and serial numbers of the unit when contacting an Independent Authorized Service Dealer (IASD) about parts and service.

Operation and Maintenance: Correct maintenance and care of the unit ensures a minimum number of problems, and keeps operating expenses at a minimum. It is the operator's responsibility to perform all safety inspections, to verify all maintenance for safe operation is performed promptly, and to have the equipment inspected periodically by an IASD. Normal maintenance, service, and replacement of parts are the responsibility of the owner/operator and are not considered defects in materials or workmanship within the terms of the warranty. Individual operating habits and usage may contribute to the need for additional maintenance or service.

When the generator requires servicing or repairs, Generac recommends contacting an IASD for assistance. Authorized service technicians are factory-trained and are capable of handling all service needs. To locate the nearest IASD, please visit the dealer locator at: www.generac.com/Dealer-Locator.

 **WARNING**

CANCER AND REPRODUCTIVE HARM

www.P65Warnings.ca.gov.

(000393a)

Table of Contents

Section 1: Safety Rules & General Information

Introduction	1
Read This Manual Thoroughly	1
Safety Rules	1
How to Obtain Service	1
General Hazards	2
Exhaust Hazards	2
Electrical Hazards	3
Fire Hazards	3
Explosion Hazards	3
Battery Hazards	4
General Rules	4
Before You Begin	4
NEC Requirements	5
Standards Index	5

Section 2: Unpacking and Inspection

General	7
Required Tools	7
Unpacking	7
Opening the Lid	8
Enclosure Panel Removal	8
Front Access Panel Removal	8
Intake Side Panel Removal	9
Customer Connections and Loose Parts	9
Rear Connections	9
Main Line Circuit Breaker (Generator Disconnect)	10
Parts Shipped Loose	10
Generator Emergency Shutdown Switch	11

Section 3: Site Selection and Preparation

Site Selection	13
Carbon Monoxide	13
Carbon Monoxide Detectors	13
Potential CO Entry Points	14
Protect the Structure	14
Fire Prevention	15
Distance Requirements	15
Fire Codes, Standards, and Guidelines	16
Generator Maintenance	16
Fresh Air for Ventilation and Cooling	16

Water Ingress Avoidance	16
Proximity to Utilities	16
Verify Wi-Fi Range	17
Transportation Recommendations	17
Suitable Mounting Surface	17
Placement on Roofs, Platforms, and Other Supporting Structures	17

Section 4: Generator Placement

Generator Placement	18
Fascia Installation (If Applicable)	18
Base Plug Installation (If Applicable)	19

Section 5: Fuel Conversion / Gas Connections

Fuel Requirements and Recommendations	20
BTU Content	20
Fuel Pressure	20
Fuel Conversion	20
Fuel Consumption	21
Fuel Line Sizing	21
Flexible Fuel Line Extensions	21
Natural Gas Pipe Sizing	22
LP Gas Pipe Sizing	22
Installing and Connecting Fuel Lines	23
Fuel Shutoff Valve	23
Flexible Fuel Line	23
Sediment Trap	23
Checking Fuel Line Connections	24
Checking Fuel Pressure	24
Performing Fuel System Leak Test	24
Natural Gas Installation (Typical)	25
LP Gas (Vapor) Installation (Typical)	26

Section 6: Electrical Connections

Generator Connections	28
Control Wiring	29
Main AC Wiring	30
Service Entrance Decals.....	30
Common Alarm Relay (Option).....	30
Battery Requirements	31
Battery Installation.....	31
Connecting the Battery	31
Battery Disposal	31

Section 7: Control Panel Startup / Testing

Control Panel Interface	32
Using the AUTO/OFF/MANUAL Buttons	32
Generator Setup	32
Activation	32
Cold Smart Start	34
Setting The Exercise Timer	34
Before Initial Startup.....	34
Install Wizard	34
Interconnect System Self Test Feature	35
Before starting, complete the following:	35
Checking Manual Transfer Switch Operation	38
Electrical Checks.....	38
Generator Tests Under Load	38
Checking Automatic Operation	39
Installation Summary.....	39
Shutting Generator Down While Under Load or During a Utility Outage.....	39

Section 8: Troubleshooting

Generator Troubleshooting	41
---------------------------------	----

Section 9: Quick Reference Guide

System Diagnosis	43
------------------------	----

Section 10: Accessories

Section 11: Diagrams

Installation Drawing (A0002360608 rev B—1 of 2)	49
Installation Drawing (A0002360608 rev B—2 of 2)	50

Section 1: Safety Rules & General Information

Introduction

Thank you for purchasing this compact, high performance, air-cooled, engine-driven generator. It is designed to automatically supply electrical power to operate critical loads during a utility power failure.

This unit is factory installed in an all-weather, metal enclosure intended exclusively for outdoor installation. This generator will operate using either vapor withdrawn liquid propane (LP) or natural gas (NG).

NOTE: This generator is suitable for supplying typical residential loads such as induction motors (sump pumps, refrigerators, air conditioners, furnaces, etc.), electronic components (computer, monitor, TV, etc.), lighting loads, and microwaves, when sized correctly. This unit is also equipped with a Wi-Fi[®] module, which allows the generator owner to monitor generator status from anywhere they have Internet access.

NOTE: Wi-Fi[®] is a registered trademark of Wi-Fi Alliance[®].

The information in this manual is accurate based on products produced at the time of publication. The manufacturer reserves the right to make technical updates, corrections, and product revisions at any time without notice.

Read This Manual Thoroughly



WARNING

Consult Manual. Read and understand manual completely before using product. Failure to completely understand manual and product could result in death or serious injury. (000100a)

If any section of this manual is not understood, contact the nearest Independent Authorized Service Dealer (IASD) or Generac Customer Service at 1-888-436-3722 (1-888-GENERAC), or visit www.generac.com for starting, operating, and servicing procedures. The owner is responsible for correct maintenance and safe use of the unit.

This manual must be used in conjunction with all other supporting product documentation supplied with the product.

SAVE THESE INSTRUCTIONS for future reference. This manual contains important instructions that must be followed during placement, operation, and maintenance of the unit and its components. Always supply this manual to any individual that will use this

unit, and instruct them on how to correctly start, operate, and stop the unit in case of emergency.

Safety Rules

The manufacturer cannot anticipate every possible circumstance that might involve a hazard. The alerts in this manual, and on tags and decals affixed to the unit, are not all inclusive. If using a procedure, work method, or operating technique that the manufacturer does not specifically recommend, verify that it is safe for others and does not render the equipment unsafe.

Throughout this publication, and on tags and decals affixed to the unit, DANGER, WARNING, CAUTION, and NOTE blocks are used to alert personnel to special instructions about a particular operation that may be hazardous if performed incorrectly or carelessly. Observe them carefully. Alert definitions are as follows:

DANGER

Indicates a hazardous situation which, if not avoided, will result in death or serious injury.

(000001)

WARNING

Indicates a hazardous situation which, if not avoided, could result in death or serious injury.

(000002)

CAUTION

Indicates a hazardous situation which, if not avoided, could result in minor or moderate injury.

(000003)

NOTE: Notes contain additional information important to a procedure and will be found within the regular text of this manual.

These safety alerts cannot eliminate the hazards that they indicate. Common sense and strict compliance with the special instructions while performing the action or service are essential to preventing accidents.

How to Obtain Service

When the unit requires servicing or repairs, contact Generac Customer Service at 1-888-GENERAC (1-888-436-3722) or visit www.generac.com for assistance.

When contacting Generac Customer Service about parts and service, always supply the complete model and serial number of the unit as given on its data decal located on the unit. Record the model and serial numbers in the spaces provided on the front cover of this manual.

General Hazards

⚠ DANGER

Loss of life. Property damage. Installation must always comply with applicable codes, standards, laws and regulations. Failure to do so will result in death or serious injury. (000190)

⚠ DANGER

Automatic start-up. Disconnect utility power and render unit inoperable before working on unit. Failure to do so will result in death or serious injury. (000191)



⚠ WARNING

Electrocution. Potentially lethal voltages are generated by this equipment. Render the equipment safe before attempting repairs or maintenance. Failure to do so could result in death or serious injury. (000187)



⚠ WARNING

Loss of life. This product is not intended to be used in a critical life support application. Failure to adhere to this warning could result in death or serious injury. (000209b)

⚠ WARNING

Accidental Start-up. Disconnect the negative battery cable, then the positive battery cable when working on unit. Failure to do so could result in death or serious injury. (000130)

⚠ WARNING

Equipment damage. Only qualified service personnel may install, operate, and maintain this equipment. Failure to follow proper installation requirements could result in death, serious injury, and equipment or property damage. (000182a)

⚠ WARNING

Equipment damage. This unit is not intended for use as a prime power source. It is intended for use as an intermediate power supply in the event of temporary power outage only. Doing so could result in death, serious injury, and equipment damage. (000247a)

⚠ WARNING

Electric shock. Only a trained and licensed electrician should perform wiring and connections to unit. Failure to follow proper installation requirements could result in death, serious injury, and equipment or property damage. (000155a)



⚠ WARNING

Moving Parts. Do not wear jewelry when starting or operating this product. Wearing jewelry while starting or operating this product could result in death or serious injury. (000115)



⚠ WARNING

Moving Parts. Keep clothing, hair, and appendages away from moving parts. Failure to do so could result in death or serious injury. (000111)



⚠ WARNING

Hot Surfaces. When operating machine, do not touch hot surfaces. Keep machine away from combustibles during use. Hot surfaces could result in severe burns or fire. (000108)

⚠ WARNING

Equipment and property damage. Do not alter construction of, installation, or block ventilation for generator. Failure to do so could result in unsafe operation or damage to the generator. (000146)

⚠ WARNING

Risk of injury. Do not operate or service this machine if not fully alert. Fatigue can impair the ability to operate or service this equipment and could result in death or serious injury. (000215a)

⚠ WARNING

Environmental Hazard. Always recycle batteries at an official recycling center in accordance with all local laws and regulations. Failure to do so could result in environmental damage, death, or serious injury. (000228)

⚠ WARNING

Injury and equipment damage. Do not use generator as a step. Doing so could result in falling, damaged parts, unsafe equipment operation, and could result in death or serious injury. (000216)

- Inspect the generator regularly, and contact the nearest IASD for parts needing repair or replacement.

Exhaust Hazards



⚠ DANGER

Asphyxiation. Running engines produce carbon monoxide, a colorless, odorless, poisonous gas. Carbon monoxide, if not avoided, will result in death or serious injury. (000103)



⚠ DANGER

Asphyxiation. Carbon monoxide can kill in minutes. Operate this unit outdoors only. Failure to do so will cause death or serious injury. (000525)

⚠️ WARNING

Equipment and property damage. Do not alter construction of, installation, or block ventilation for generator. Failure to do so could result in unsafe operation or damage to the generator. (000146)



⚠️ WARNING

Asphyxiation. Always use a battery operated carbon monoxide alarm indoors and installed according to the manufacturer's instructions. Failure to do so could result in death or serious injury. (000178a)

Electrical Hazards



⚠️ DANGER

Electrocution. Contact with bare wires, terminals, and connections while generator is running will result in death or serious injury. (000144)



⚠️ DANGER

Electrocution. Never connect this unit to the electrical system of any building unless a licensed electrician has installed an approved transfer switch. Failure to do so will result in death or serious injury. (000150)

⚠️ DANGER

Electrical backfeed. Use only approved switchgear to isolate generator from the normal power source. Failure to do so will result in death, serious injury, and equipment damage. (000237)



⚠️ DANGER

Electrocution. Verify electrical system is properly grounded before applying power. Failure to do so will result in death or serious injury. (000152)



⚠️ DANGER

Electrocution. Do not wear jewelry while working on this equipment. Doing so will result in death or serious injury. (000188)



⚠️ DANGER

Electrocution. Water contact with a power source, if not avoided, will result in death or serious injury. (000104)



⚠️ DANGER

Electrocution. In the event of electrical accident, immediately shut power OFF. Use non-conductive implements to free victim from live conductor. Apply first aid and get medical help. Failure to do so will result in death or serious injury. (000145)

Fire Hazards



⚠️ WARNING

Fire hazard. Do not obstruct cooling and ventilating airflow around the generator. Inadequate ventilation could result in fire hazard, possible equipment damage, death or serious injury. (000217)



⚠️ WARNING

Fire and explosion. Installation must comply with all local, state, and national electrical building codes. Noncompliance could result in unsafe operation, equipment damage, death, or serious injury. (000218)



⚠️ WARNING

Fire hazard. Use only fully-charged fire extinguishers rated "ABC" by the NFPA. Discharged or improperly rated fire extinguishers will not extinguish electrical fires in automatic standby generators. (000219)



⚠️ WARNING

Electrocution. Refer to local codes and standards for safety equipment required when working with a live electrical system. Failure to use required safety equipment could result in death or serious injury. (000257)



⚠️ WARNING

Risk of Fire. Unit must be positioned in a manner that prevents combustible material accumulation underneath. Failure to do so could result in death or serious injury. (000147)

Comply with regulations the local agency for workplace health and safety has established. Also, verify that the generator is installed in accordance with the manufacturer's instructions and recommendations. Following proper installation, do nothing that might alter a safe installation and render the unit in non-compliance with the aforementioned codes, standards, laws, and regulations.

Explosion Hazards



⚠️ DANGER

Explosion and fire. Fuel and vapors are extremely flammable and explosive. No leakage of fuel is permitted. Keep fire and spark away. Failure to do so will result in death or serious injury. (000192)

⚠️ DANGER

Explosion and fire. Connection of fuel source must be completed by a qualified professional technician or contractor. Incorrect installation of this unit will result in death, serious injury, and property and equipment damage. (000151a)



⚠️ DANGER

Risk of fire. Allow fuel spills to completely dry before starting engine. Failure to do so will result in death or serious injury. (000174)



WARNING

Risk of Fire. Hot surfaces could ignite combustibles, resulting in fire. Fire could result in death or serious injury.

(000110)

Battery Hazards



DANGER

Electrocution. Do not wear jewelry while working on this equipment. Doing so will result in death or serious injury.

(000188)



WARNING

Explosion. Do not dispose of batteries in a fire. Batteries are explosive. Electrolyte solution can cause burns and blindness. If electrolyte contacts skin or eyes, flush with water and seek immediate medical attention.

(000162)



WARNING

Explosion. Batteries emit explosive gases while charging. Keep fire and spark away. Wear protective gear when working with batteries. Failure to do so could result in death or serious injury.

(000137a)



WARNING

Electrical shock. Disconnect battery ground terminal before working on battery or battery wires. Failure to do so could result in death or serious injury.

(000164)



WARNING

Risk of burns. Batteries contain sulfuric acid and can cause severe chemical burns. Wear protective gear when working with batteries. Failure to do so could result in death or serious injury.

(000138a)



WARNING

Risk of burn. Do not open or mutilate batteries. Batteries contain electrolyte solution which can cause burns and blindness. If electrolyte contacts skin or eyes, flush with water and seek immediate medical attention.

(000163a)

WARNING

Environmental Hazard. Always recycle batteries at an official recycling center in accordance with all local laws and regulations. Failure to do so could result in environmental damage, death, or serious injury.

(000228)

Always recycle batteries in accordance with local laws and regulations. Contact your local solid waste collection site or recycling facility to obtain information on local recycling processes. For more information on battery recycling, visit the Battery Council International website at: <http://batteryCouncil.org>.

General Rules

DANGER

Loss of life. Property damage. Installation must always comply with applicable codes, standards, laws and regulations. Failure to do so will result in death or serious injury.

(000190)

DANGER

Electrical backfeed. Use only approved switchgear to isolate generator from the normal power source. Failure to do so will result in death, serious injury, and equipment damage.

(000237)

WARNING

Equipment damage. Only qualified service personnel may install, operate, and maintain this equipment. Failure to follow proper installation requirements could result in death, serious injury, and equipment or property damage.

(000182a)



WARNING

Electrocution. Refer to local codes and standards for safety equipment required when working with a live electrical system. Failure to use required safety equipment could result in death or serious injury.

(000257)



WARNING

Consult Manual. Read and understand manual completely before using product. Failure to completely understand manual and product could result in death or serious injury.

(000100a)

- Follow all safety precautions in the owner's manual, installation guidelines manual, and other documents included with the equipment.
- Never energize a new system without opening all disconnects and breakers.
- Always consult local code for additional requirements for where unit is being installed.
- Incorrect installation can result in personal injury and damage to the unit. It may also result in the warranty being suspended or voided. All instructions listed below must be followed including location clearances and pipe sizes.

Before You Begin

- Contact local inspector or city hall to be aware of all federal, state, and local codes which could impact installation. Secure all required permits before installing.
- Fully comply with all relevant NEC, NFPA, and OSHA standards, as well as all federal, state, and local building and electric codes. This unit must be installed in accordance with current NFPA 37 and NFPA 70 standards, and any other federal, state, and local codes for minimum distances from other structures.

- Verify capacity of NG meter or LP tank in regards to providing sufficient fuel for both the unit and other household and operating appliances.

NEC Requirements

Local code enforcement may require Arc Fault Circuit Interrupters (AFCIs) to be incorporated into the transfer switch distribution panel. The transfer switch provided with this generator has a distribution panel which will accept AFCIs (pre-wired transfer switches only).

Siemens Part No. Q115AF - 15A or Q120AF - 20A can be obtained from a local electrical wholesaler and will simply replace any of the single pole circuit breakers supplied in the pre-wired transfer switch distribution panel.

Standards Index



WARNING

Loss of life. This product is not intended to be used in a critical life support application. Failure to adhere to this warning could result in death or serious injury. (000209b)

Strictly comply with all applicable national, state, and local laws, as well as codes or regulations pertaining to the installation of this engine-generator power system. Use the most current version of applicable codes or standards relevant to the local jurisdiction, generator used, and installation site.

NOTE: Not all codes apply to all products and this list is not all-inclusive. In the absence of pertinent local laws and standards, the following publications may be used as a guide (these apply to localities which recognize NFPA and ICC).

1. National Fire Protection Association (NFPA) 70: The NATIONAL ELECTRIC CODE (NEC) *
2. NFPA 10: Standard for Portable Fire Extinguishers *
3. NFPA 30: Flammable and Combustible Liquids Code *
4. NFPA 37: Standard for Stationary Combustion Engines and Gas Turbines *
5. NFPA 54: National Fuel Gas Code *
6. NFPA 58: Standard for Storage and Handling Of Liquefied Petroleum Gases *
7. NFPA 68: Standard On Explosion Protection By Deflagration Venting *
8. NFPA 70E: Standard For Electrical Safety In The Workplace *
9. NFPA 110: Standard for Emergency and Standby Power Systems *

10. NFPA 211: Standard for Chimneys, Fireplaces, Vents, and Solid Fuel Burning Appliances *
11. NFPA 220: Standard on Types of Building Construction *
12. NFPA 5000: Building Code *
13. International Building Code **
14. Agricultural Wiring Handbook ***
15. Article X, NATIONAL BUILDING CODE
16. ASAE EP-364.2 Installation and Maintenance of Farm Standby Electric Power ****
17. ICC:IFGC

This list is not all-inclusive. Check with the Authority Having Local Jurisdiction (AHJ) for any local codes or standards which may be applicable to your jurisdiction. The above listed standards are available from the following internet sources:

* www.nfpa.org

** www.iccsafe.org

*** www.nerc.org Rural Electricity Resource Council P.O. Box 309 Wilmington, OH 45177-0309

**** www.asabe.org American Society of Agricultural & Biological Engineers 2950 Niles Road, St. Joseph, MI 49085

This page intentionally left blank.

Section 2: Unpacking and Inspection

General

NOTE: Carefully inspect contents for damage after unpacking. Unpack and inspect unit immediately upon delivery to identify any damage which may have occurred in transit. Any claims for shipping damage must be filed as soon as possible with freight carrier. This is especially important if unit will not be installed for a period of time.

- This standby generator is ready for installation with a factory supplied and pre-mounted base pad and has a weather protective enclosure intended for outdoor installation only.
- If any loss or damage is noted at time of delivery, have delivery person(s) note all damage on the freight bill, or affix their signature under consignor's memo of loss or damage.
- If a loss or damage is noted after delivery, separate damaged materials and contact freight carrier for claim procedures.
- "Concealed damage" is understood to mean damage to contents of a package not evident at time of delivery, but discovered later.

Required Tools

- General SAE and Metric hand tools
 - Wrenches
 - Sockets
 - Screwdrivers
- Standard electrician's hand tools
 - Drill and bits for mounting and routing conduits
- 4 mm hex key (for access to customer connections)
- 3/16 in hex key (test port on fuel regulator)
- Manometer (for fuel pressure checks)
- Meter capable of measuring AC/DC voltage and frequency
- Torque wrenches

Unpacking

Proceed as follows to unpack the generator:

1. Remove outer shipping carton.
2. See [Figure 2-1](#). Remove wood frame.

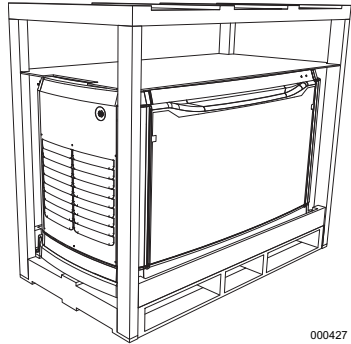

Figure 2-1. Crated Generator

3. See [Figure 2-2](#). Lid will be locked. A set of keys is attached to the cardboard sheet on top of unit. An additional set is attached to the pallet bracket on the front intake end of unit. Remove keys from cardboard and pallet bracket.

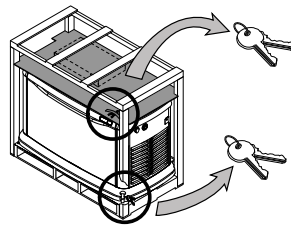

Figure 2-2. Keys As Shipped

NOTE: The enclosed keys provided with this unit are intended for service personnel only. (Part number 0G66240KEY)

IMPORTANT NOTE: DO NOT perform next step until generator has been transported to installation site.

- See [Figure 2-3](#). Remove bolts and pallet brackets (A). Exercise caution when removing generator. Dragging it off pallet will damage base. The unit must be lifted from wooden pallet to remove.

NOTE: Bolts and pallet brackets are provided only for shipping purposes and can be discarded after removal.

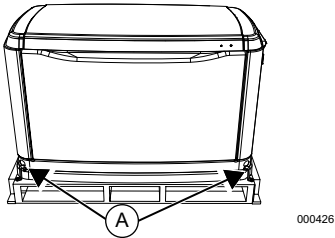

Figure 2-3. Pallet Bracket Locations

Opening the Lid

Proceed as follows to open the generator lid:

- Use keys to open generator lid.
- See [Figure 2-4](#). Two locks (A) secure lid; one on each side. Press down on lid above side lock, and unlock latch to correctly open lid.

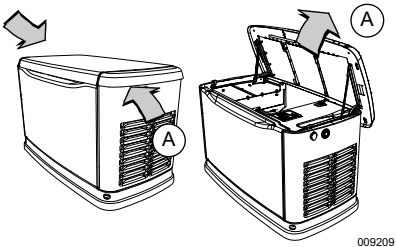

Figure 2-4. Opening the Lid

- Repeat for other side. Lid may appear stuck if pressure is not applied from the top.

NOTE: Always verify side locks are unlocked before attempting to lift lid.

Enclosure Panel Removal

Generator installation requires removal of front panel and intake side panel. Remove these panels when necessary. Proceed as follows to remove the panels.

Front Access Panel Removal

See [Figure 2-5](#). Remove front access panel (A) by lifting straight up and out once lid is open.

NOTE: Always lift front access panel straight up before pulling away from enclosure (B and C). Do not pull panel away from the enclosure before lifting up (D).

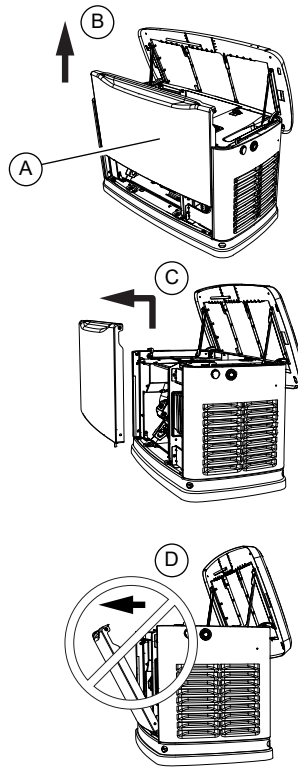

Figure 2-5. Remove Front Access Panel

Intake Side Panel Removal

See **Figure 2-6**. The intake side panel (A) must be removed to access battery compartment, fuel regulator, and sediment trap.

1. Raise lid and remove front panel.
2. Use a hex key to remove two mounting screws (B) and the hex screw (C) on the L-bracket.
3. Lift intake panel up and away from generator.
4. Inspect for any hidden freight damage. Contact freight carrier if damage is present.

NOTE: Always lift intake side panel straight up before pulling away from enclosure. Do not pull panel away from enclosure before lifting up (D).

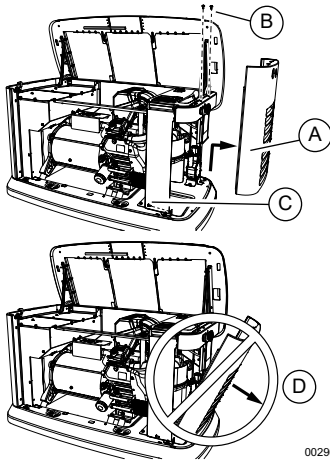
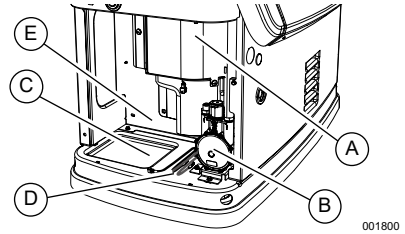

Figure 2-6. Intake Side Panel Removal

Customer Connections and Loose Parts

See **Figure 2-7** and **Figure 2-8** for customer connections and loose parts location. **Figure 2-10** illustrates parts shipped loose.



A	Customer electrical connection area (behind access panel)
B	Fuel regulator with sediment trap
C	Battery compartment (battery not supplied) (PN 0H3421S)
D	Positive (+) and negative (-) battery cables
E	Location of "Loose Shipped Parts"

Figure 2-7. Customer Connection Area and Loose Parts Location

Rear Connections

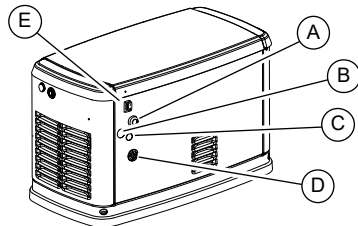

A	Wi-Fi module
B	Main AC/Control wiring hole for 1-1/4 in conduit
C	Main AC/Control wiring hole for 3/4 in conduit (if equipped)
D	Fuel connection hole
E	Generator emergency shutdown switch

Figure 2-8. Rear Connections

NOTE: Generator is equipped with a Wi-Fi module. See Wi-Fi module owner's manual for further instruction.

Main Line Circuit Breaker (Generator Disconnect)

See **Figure 2-9**. The 2-pole main line circuit breaker (MLCB) (generator disconnect) (A) is rated according to relevant specifications.

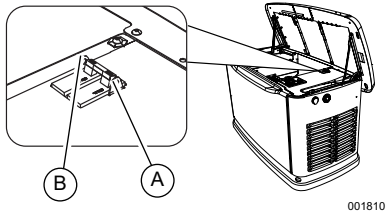
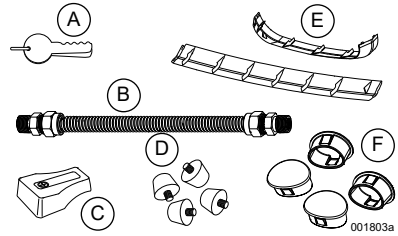

Figure 2-9. Generator Main Line Circuit Breaker

Generator MLCB (generator disconnect) can be locked in OFF (OPEN) position for security during maintenance or transfer switch service. Use an appropriately-sized padlock (not included) with a shackle long enough to pass through both lock tabs (B).

NOTE: DO NOT leave generator MLCB (generator disconnect) locked in the OFF (OPEN) position during normal generator operation. Leaving the generator MLCB (generator disconnect) in OFF (OPEN) position will prevent generator from powering structure during a power outage when placed in AUTO mode.

Parts Shipped Loose



A	Keys
B	Flexible fuel line
C	Battery terminal cap
D	Rubber mounts (only for units including fascia)
E	Fascia (if applicable)
F	Base plugs (if applicable)
G	Decal—Service entrance warning (not shown)
H	Decal—Through conductors warning (not shown)
J	Decal—Service disconnect (not shown)
K	Owner's and installation manuals (not shown)
L	Wi-Fi manual (not shown)
M	Wi-Fi Quick Start Guide (not shown)

Figure 2-10. Parts Shipped Loose

Generator Emergency Shutdown Switch

CAUTION

Equipment Damage. The emergency shutdown switch is not to be used to power down the unit under normal operating circumstances. Doing so will result in equipment damage. (000399a)

All generators are equipped with an external means of shutting down the generator which complies with the latest NEC code requirement. The primary generator shutdown sequence is described in [Control Panel Startup / Testing](#).

See [Figure 2-11](#). An emergency shutdown switch (A) is located on the exterior of the generator back panel. This switch shuts down the generator and disables restarts.

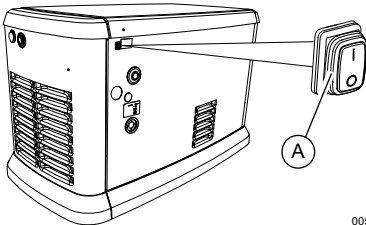

005492

Figure 2-11. Emergency Shutdown Switch (all models)

NOTE: Whenever possible, perform primary shutdown procedure before disabling generator with emergency shutdown switch.

See [Figure 2-12](#). 14–26 kW generators have an emergency shutdown switch (B) located inside the generator.

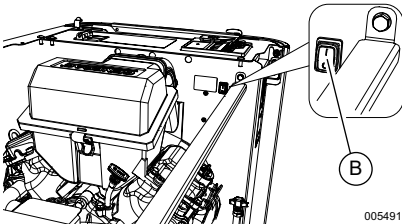

005491

Figure 2-12. Emergency Shutdown Switch (14–26 kW)

NOTE: Generator will not start if either switch is OPEN (O). Controller displays a “Shutdown Switch” alarm, and red LED “Alarm” light illuminates and flashes until switch or switches are CLOSED (I) and alarm is cleared by pressing OFF mode button, and then ENTER. Once cleared, generator can be placed back in AUTO or MANUAL.

This page intentionally left blank.

Section 3: Site Selection and Preparation

Site Selection

Site selection is critical for safe generator operation. It is important to discuss these factors with the installer when selecting a site for generator installation:

- Carbon monoxide
- Fire prevention
- Fresh air for ventilation and cooling
- Water ingress prevention
- Proximity to utilities
- Suitable mounting surface
- Readily accessible for maintenance, repair, and first responders

The following pages describe each of these factors in detail.

NOTE: The term “structure” is used throughout this section to describe the home or building where generator is being installed. Illustrations depict a typical residential home. However, instructions and recommendations presented in this section apply to all structures regardless of type.

Carbon Monoxide



▲ DANGER

Asphyxiation. Running engines produce carbon monoxide, a colorless, odorless, poisonous gas. Carbon monoxide, if not avoided, will result in death or serious injury.

(000103)

IMPORTANT NOTE: Move to fresh air immediately and seek medical attention if you feel sick, dizzy, or weak while the generator is running or after it stops.

Generator exhaust contains carbon monoxide (CO)—a poisonous, potentially lethal gas that cannot be seen or smelled. The generator must be installed in a well ventilated area away from windows, doors, and openings. The selected location should not allow exhaust gases to be drawn into structures where people or animals may be present.

Carbon Monoxide Detectors

See [Figure 3-1](#). CO detectors (K) must be installed and used to monitor for CO and to warn individuals about the presence of CO. CO detectors must be installed and tested in accordance with the CO detector manufacturer’s instructions and warnings. Contact local building inspection department for any applicable requirements concerning CO detectors. See NFPA 72, National Fire Alarm and Signaling Code, and Section R315 in the ICC International Residential Code for more information.

IMPORTANT NOTE: Common smoke alarms do NOT detect CO gas. Do not rely on smoke alarms to protect residents or animals from CO. The only way to detect CO is to have functioning CO alarms.

Potential CO Entry Points

See [Figure 3-1](#). Generator exhaust can enter a structure through large openings, such as windows and doors. However, exhaust and CO can also seep into the structure through smaller, less obvious openings.

Protect the Structure

Verify structure itself is correctly caulked and sealed to prevent air from leaking in or out. Voids, cracks, or openings around windows, doors, soffits, pipes, and vents can allow exhaust gas to be drawn into the structure.

Some examples of potential entry points are described and included in, but not limited to, the accompanying table.

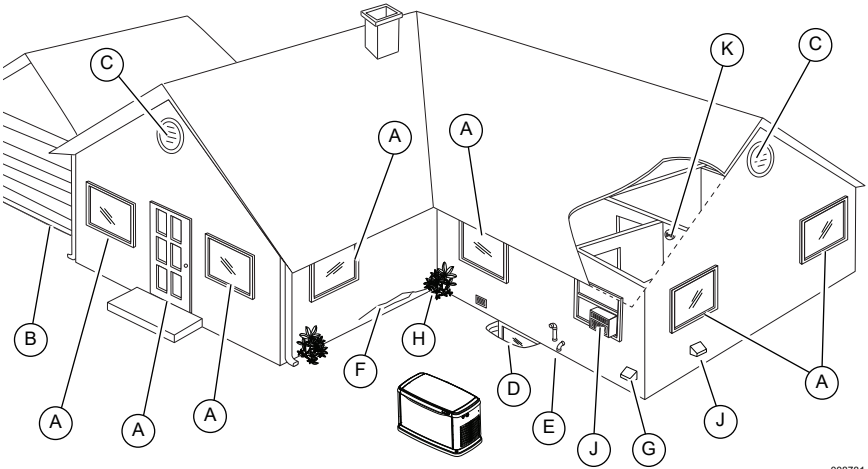

008781

Figure 3-1. Carbon Monoxide—Potential Entry Points

ID	Entry Point	Description / Comments
A	Windows and doors	Architectural details which can be (or are) opened to admit fresh air into the structure.
B	Garage door	CO can leak into garage if door is open, or does not seal correctly when closed.
C	Attic vent	Attic vents, ridge vents, crawl space vents, and soffit vents can all admit generator exhaust.
D	Basement windows	Windows or hatches allowing ventilation to or from lower level of a structure.
E	Furnace intake/exhaust vent	Air intake and exhaust pipes for furnace.
F	Wall cracks	Includes (but not limited to) cracks in wall, foundation, mortar, or air gaps around doors, windows, and pipes. See Protect the Structure .
G	Dryer vent	Exhaust duct for clothes dryer.
H	Airflow restrictions	Structural features, including but not limited to: corners, alcoves, fences, courtyards, and areas with heavy vegetation can restrict correct airflow around unit. Exhaust gases can be collected in these areas.
J	HVAC components	Do not direct generator discharge into HVAC components, including but not limited to: make up air systems, AC condensers, and window AC units. IMPORTANT NOTE: Mechanical and gravity outdoor air intake openings for HVAC supply air systems shall be located according to Section 401 in the ICC Mechanical Code. See ICC Mechanical Code for any additional requirements.

Fire Prevention

The generator must be installed at a safe distance away from combustible materials. Engine, alternator, and exhaust system components become very hot during operation. Fire risk increases if unit is not correctly ventilated, is not correctly maintained, operates too close to combustible materials, or if fuel leaks exist. Also, accumulations of flammable debris within or outside the generator enclosure may ignite.

Distance Requirements

See [Figure 3-2](#). Minimum clearances must be maintained around the generator enclosure. These clearances are primarily for fire prevention, but also to provide sufficient room for removing front and end panels for maintenance purposes.

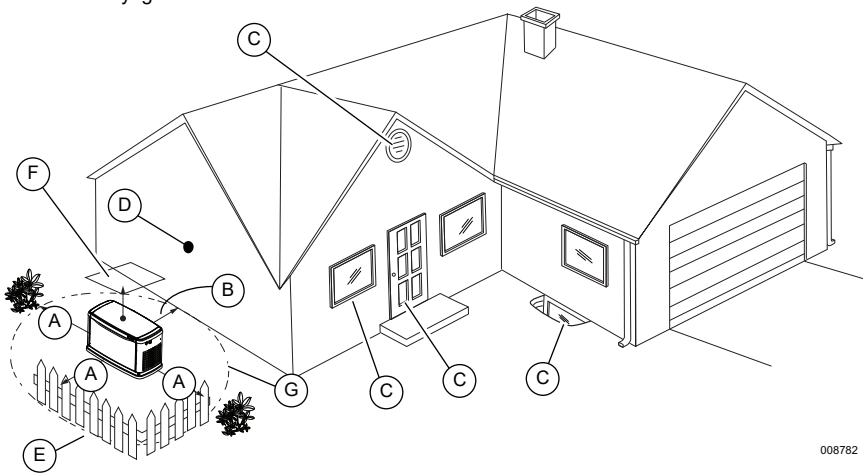

008782

Figure 3-2. Generator Distance Requirements

ID	Description	Definition
A	Front and end clearance	Minimum clearance from the front and ends of generator must be 3 ft (0.91 m). This includes shrubs, bushes, and trees.
B	Rear clearance	Fuel and electrical connections are made here. 18 in (457 mm) minimum clearance per SwRI testing, labeling, and listing, unless state or local codes dictate otherwise.
C	Windows, vents, and openings	No operable windows, doors, vents, window wells, or openings in the wall are permitted closer to any point of the generator than what is permitted by locally adopted codes. See Fire Codes, Standards, and Guidelines for more information.
D	Existing wall	The generator should not be placed closer to existing walls than what is permitted by locally adopted codes, while abiding by the front, end, and rear clearances listed above.
E	Removable fence	A removable barrier (non-permanent; without footings) installed as a visual surround. Removable fence panels for servicing cannot be placed less than 3 ft (0.91 m) in front of the generator.
F	Overhead clearance	5 ft (1.52 m) minimum distance from any structure, overhang, or projections from wall.
G	Maintenance and servicing	Maneuvering space around generator for performing routine maintenance tasks such as battery replacement and engine service. Do not attempt to conceal generator with shrubs, bushes, or plants. See NEC Article 110.26 for more information.

Fire Codes, Standards, and Guidelines

Generator installation must comply strictly with ICC IFGC, NFPA 37, NFPA 54, NFPA 58, and NFPA 70 standards. These standards prescribe the minimum safe clearances around and above the generator enclosure.

NFPA 37

NFPA 37 is the The National Fire Protection Association’s standard for the installation and use of stationary combustion engines. Its requirements limit the spacing of an engine generator to a minimum of 5 ft (1.5 m) from an opening in a structure or a structure having combustible walls, and require the engine generator to be located where it is readily accessible for maintenance, repair, and first responders. The standard contains an exception which allows an engine generator to be closer to a combustible wall when approved testing demonstrates a fire originating at the engine does not ignite the combustible structure.

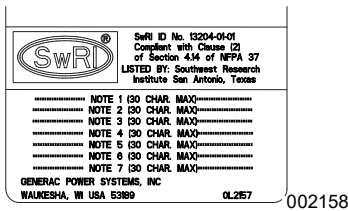

Figure 3-3. Southwest Research Institute Marking

NOTE: The Southwest Research Institute (SwRI) is a nationally recognized third party testing and listing agency. SwRI testing certifies a reduction of the minimum clearance from the engine generator to a structure having combustible walls.

The test criteria was to determine the worst case fire scenario within the generator and to determine the ignitability of items outside the engine enclosure at various distances. The enclosure is constructed of non-combustible materials, and the results and conclusions from the independent testing lab indicated that any fire within the engine generator enclosure would not pose any ignition risk to nearby combustibles or structures.

Based on this testing and the requirements of NFPA 37, Sec 4.1.4, the guidelines for installation of the generators listed above are changed to 18 in (457 mm) from the back side of the generator and 3 ft (914 mm) from the front and ends of the generator to a struc-

ture having combustible walls. This offset reduction does not apply to clearances from openings in the structure. For adequate maintenance and airflow clearance, the area above the generator should be at least 5 ft (1.52 m) with a minimum of 3 ft (0.91 m) at the front and ends of the enclosure. This includes trees, shrubs, and bushes. Vegetation not in compliance with these clearance parameters could obstruct air flow. In addition, exhaust fumes from the generator could inhibit plant growth. See **Figure 3-2** and the accompanying descriptions.

Generator Maintenance

Regular maintenance is crucial for minimizing exhaust emissions and reducing the risk of fire or equipment failure. For example:

- A dirty air filter or low engine oil level may cause engine to overheat.
- Incorrect spark plug gaps may cause engine backfiring and incomplete combustion.

IMPORTANT NOTE: See Maintenance section of generator owner’s manual to view a table of scheduled maintenance tasks and procedures. Perform all maintenance tasks as directed.

Fresh Air for Ventilation and Cooling

Install unit where air inlet and outlet openings will not become obstructed by leaves, grass, snow, etc. If prevailing winds will cause blowing or drifting, consider using a windbreak at a safe distance to protect the unit.

Water Ingress Avoidance

- Select a location on high ground where water levels will not rise and flood the generator. This unit should not operate in, or be subjected to, standing water.
- Install unit where rain gutter downspouts, roof run-off, landscape irrigation, water sprinklers, or sump pump discharge does not flood unit or spray enclosure, including any air inlet or outlet openings.
- Excess moisture can cause excess corrosion and decrease life expectancy of the unit.

Proximity to Utilities

- Contact local utility providers and verify proposed site selection meets all required utility placement requirements before installation. This could affect warranty coverage.

- Remember, laws and or codes may regulate distance and location of unit to specific utilities.
- It is recommended to pick a location where the generator is as close as possible to the transfer switch and the fuel supply, while verifying the site location conforms to the rest of the Site Selection section.

Verify Wi-Fi Range (If Applicable)

See wireless communication accessory manual shipped with the unit if planning to use the Wi-Fi feature.

Transportation Recommendations

Use a suitable cart or equipment to carry generator, including wooden pallet, to installation site. Place cardboard between cart and generator to prevent any damage or scratches to generator.

Do not lift, carry, or move generator by grasping the louvers. Doing so may bend or damage the sheet metal.

Suitable Mounting Surface

Select non-combustible base type as desired or as required by local laws or codes. The generator is typically approved to be placed on pea gravel, crushed stone, a concrete base pad, or an approved composite base pad. Follow all applicable codes if a concrete base pad is required. Verify any base pad meets or exceeds local codes and requirements for wind ratings.

See [Figure 3-4](#). Prepare a rectangular area approximately 5 in (127 mm) thick (A) and approximately 3 in (76.2 mm) longer and wider (B) than the footprint of the generator on all sides when using pea gravel or crushed stone.

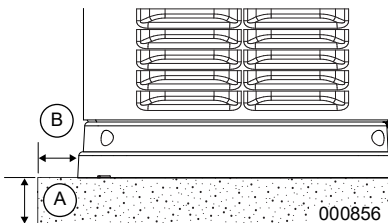

Figure 3-4. Pea Gravel or Crushed Stone

Concrete base pads must be appropriately sized in accordance with national, state, or local building codes.

Verify surface where generator will be mounted is compacted, leveled, and will not erode over time. Generator must be level within 0.5 in (13 mm) all around.

Recommended concrete base pads:
10000007852 – 3 in (76.2 mm),
10000007848 – 4 in (102 mm).

Placement on Roofs, Platforms, and Other Supporting Structures

Where required to place generator on a roof, platform, deck, or other supporting structure, generator must be placed in accordance with the requirements in NFPA 37, Section 4.1.3. See [Fire Codes, Standards, and Guidelines](#) for permissible clearance reductions. Surface beneath the generator and beyond must be noncombustible to a minimum distance of 12 in (30.5 cm). Contact local building inspection department or fire department to determine which noncombustible materials are approved for installation.

Section 4: Generator Placement

Generator Placement

See [Figure 4-1](#). All air-cooled generators come with an integrated composite pad. This integrated composite pad elevates the generator and helps prevent water from pooling around base.

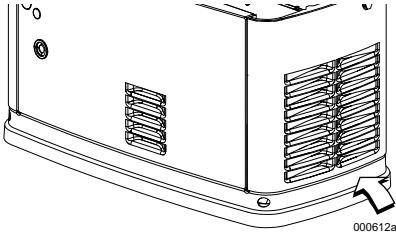

Figure 4-1. Integrated Composite Pad

The integrated composite pad allows the generator to be placed on two types of manufacturer approved surfaces:

- on 5 in (12.7 cm) of compacted pea gravel or crushed stone
- on a manufacturer approved composite or concrete base pad

See local codes to verify what type of site base is required. If a concrete pad is required, all federal, state, and local codes must be followed. Place generator, with integrated composite pad attached, and position correctly as per dimensional information given in [Site Selection and Preparation](#).

NOTE: Generator must be level within 0.5 in (13 mm).

NOTE: See [Figure 4-2](#). DO NOT remove integrated composite pad for mounting generator to concrete. The integrated composite pad is pre-drilled to accommodate mounting bolts.

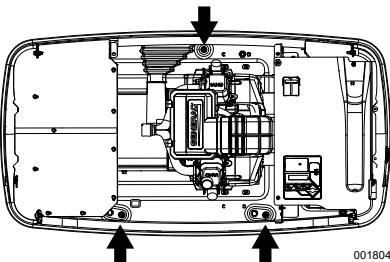

Figure 4-2. Mounting Hole Locations

Three mounting holes are available if codes require securing generator to concrete. Mounting holes are located inside the generator compartment—two in front and one in back.

Three 3/8 in (or M10) lag bolts (not supplied) are recommended for securing generator to a concrete pad.

NOTE: The top of the generator carton has a template which can be used to mark concrete pad to pre-drill the mounting holes.

Fascia Installation (If Applicable)

1. Locate the four threaded black rubber bumpers supplied with loose parts. (See [Parts Shipped Loose](#).)
2. See [Figure 4-3](#). Remove rubber bumpers from bag and screw them into threaded holes located inside the end pieces of the fascia (two each) opposite one another (A).

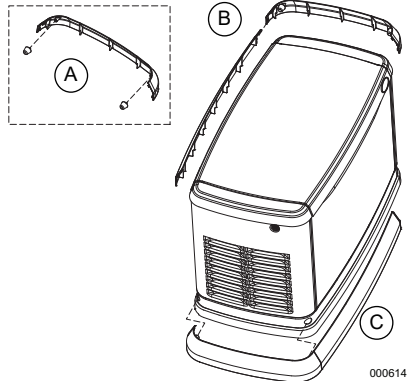

Figure 4-3. Fascia Installation

3. Snap one of the end pieces into one of the front/rear pieces of fascia. Repeat this action with the other two remaining pieces of fascia (B).

NOTE: Do not assemble all four pieces together at this point.

4. Place both assemblies at generator base and fit the rubber mounts into the lifting holes in the generator base (C).
5. Once aligned, snap together the two remaining connection points.

Base Plug Installation (If Applicable)

Proceed as follows to install base plugs:

1. Locate the four base plugs supplied with the loose parts. (See **Parts Shipped Loose**.)
2. Locate the four holes in the corners of the generator base.
3. See **Figure 4-1**. Install base plugs into generator base.

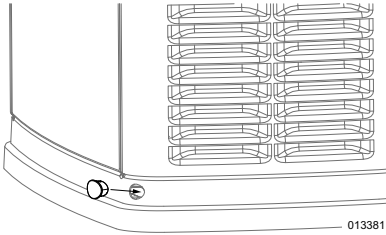

Figure 4-1. Installing Base Plugs

Section 5: Fuel Conversion / Gas Connections

Fuel Requirements and Recommendations



▲ DANGER

Explosion and fire. Fuel and vapors are extremely flammable and explosive. No leakage of fuel is permitted. Keep fire and spark away. Failure to do so will result in death or serious injury. (000192)

NOTE: NG is lighter than air and will collect in high areas. LP gas is heavier than air and will settle in low areas.

LP gas should only use a vapor withdrawal system. This type of system uses vapors formed above liquid propane in the storage tank.

The unit will run on NG or LP gas, but has been factory-configured to run on NG.

NOTE: Should the primary fuel need to be changed to LP gas, the fuel system must be reconfigured. See [Fuel Conversion](#) for instructions on converting the fuel system.

BTU Content

Recommended fuels should have a BTU content of at least 1,000 BTU/ft³ (37.26 MJ/m³) for NG; or at least 2,500 BTU/ft³ (93.15 MJ/m³) for LP gas.

NOTE: BTU fuel content information is available from fuel supplier.

Fuel Pressure

Required fuel pressure for NG is 3.5–7.0 in water column (0.87–1.74 kPa) at generator fuel inlet. Required fuel pressure for LP gas is 10–12 in water column (2.49–2.99 kPa) at generator fuel inlet.

NOTE: The primary regulator for LP gas supply is NOT INCLUDED with generator.

NOTE: All pipe sizing, construction, and layout must comply with NFPA 54 for NG applications and NFPA 58 or ICC IFGC for LP gas

applications. Verify fuel pressure NEVER drops below required specification once generator is installed. See the NFPA website at www.nfpa.org for further information regarding NFPA requirements.

Always contact local fuel suppliers or fire marshal to verify codes and regulations for correct installation. Local codes will mandate correct routing of gaseous fuel line piping around gardens, shrubs, and other landscaping.

Piping strength and connections should be given special consideration for installations in areas at risk for flooding, tornadoes, hurricanes, earthquakes, and unstable ground.

IMPORTANT NOTE: Use an approved pipe sealant or joint compound on all threaded NPT fittings.

NOTE: All installed gaseous fuel piping must be purged and leak tested prior to initial startup in accordance with local codes, standards, and regulations.

Fuel Conversion

Proceed as follows to convert from NG configuration to LP gas.

See [Figure 5-1](#) for fuel conversion knob (A) locations. Orange fuel conversion knob is located beneath fuel mixer on 10 kW units (B) and above fuel mixer on 14 kW–26 kW units (C).

To select fuel type, turn fuel conversion knob towards marked fuel source arrow until it stops. Fuel conversion knob will rotate 180° and slide into mixer body when converting to LP gas.

NOTE: It may be necessary to remove intake snorkel to access fuel conversion knob on 26 kW units.

NOTE: The fuel selection (LP/NG) must be entered on the controller during initial startup using the [Install Wizard](#) navigation menu, or in EDIT menu under "Fuel Selection."

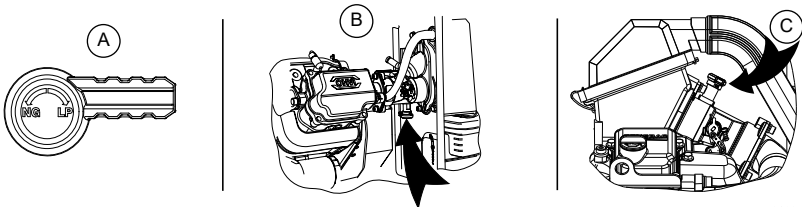

Figure 5-1. Fuel Conversion Knob Locations

014655

Fuel Consumption

Generator	Natural Gas*		Propane**	
	1/2 Load	Full Load	1/2 Load	Full Load
10 kW	2.86 / 101	3.60 / 127	0.97 / 3.66 / 36	1.48 / 5.62 / 54
14 kW	5.52 / 195	7.25 / 256	1.81 / 6.87 / 65	3.07 / 11.61 / 112
18 kW	4.79 / 169	6.99 / 247	1.70 / 6.45 / 62	3.02 / 11.44 / 110
20 kW	4.64 / 164	8.13 / 287	2.36 / 8.95 / 86	3.74 / 14.15 / 136
22 kW	5.78 / 204	9.26 / 327	2.53 / 9.57 / 92	3.90 / 14.77 / 142
24 kW	5.75 / 203	8.66 / 306	2.53 / 9.57 / 92	3.90 / 14.77 / 142
26 kW	5.32 / 188	9.43 / 333	2.06 / 7.78 / 75	3.63 / 13.73 / 132

* Natural gas is in m³/h / ft³/h

** Propane is in gal/h (LP) / L/h (LP) / ft³/h (LPV)

*** Values given are approximate

These are approximate values. Use the appropriate spec sheet or fuel data decal for specific values. Verify gas meter is capable of providing enough fuel flow to include household appliances and all other loads.

NOTE: The fuel supply and pipe **MUST** be sized at 100% load BTU/h (Megajoule/h) rating.

Always see fuel data decal for the correct BTU/h or Megajoule/h, and required fuel pressures:

- Natural Gas:

$$\text{BTU/h} = \text{ft}^3/\text{h} \times 1000$$

$$\text{Megajoules/h} = \text{m}^3/\text{h} \times 37.26$$

- Liquid Propane Gas (Vapor):

$$\text{BTU/h} = \text{ft}^3/\text{h} \times 2500$$

$$\text{Megajoules/h} = \text{m}^3/\text{h} \times 93.15$$

Fuel Line Sizing

Selecting the correct size fuel line is crucial to correct operation of the unit.

IMPORTANT NOTE: Generator inlet size DOES NOT dictate size of gas pipe to be used!

For further information, see NFPA 54 for NG, or NFPA 58 or ICC IFGC for LP.

Measure distance from generator to fuel source on a low pressure gas system.

IMPORTANT NOTE: Generator should be plumbed directly from the fuel source through an appropriately sized and correctly placed fuel pressure regulator, not off the end of an existing low pressure system.

Flexible Fuel Line Extensions

Part #	Length	Interior Diameter
10000006498	24 in (61 cm)	1 in (25 mm)
10000000499	48 in (122 cm)	1 in (25 mm)
10000000500	72 in (183 cm)	1 in (25 mm)
10000009776	48 in (122 cm)	3/4 in (19 mm)
10000009777	72 in (183 cm)	3/4 in (19 mm)
10000009793	24 in (61 cm)	3/4 in (19 mm)

Natural Gas Pipe Sizing

To determine correct NG pipe size, find the kW rating of generator in the left column, and trace to the right. The number to the right is maximum length (measured in ft / m) allowed for the pipe sizes on top. Pipe sizes are measured by trade size diameter to include any fittings, valves (must be full flow), elbows, tees, or angles.

NOTE: See Table B.3.2 in NFPA 54 or Table A.2.2 in the ICC IFGC, Equivalent Lengths of Pipe Fittings and Valves for the correct values to be added to overall fuel piping length. Tables are based on schedule 40 black pipe. If installing any other piping system, follow pipe sizing charts for selected piping system.

Table 5-1. NG Pipe Sizing

Pipe Size (in / mm)	For 5–7 in Water Column (1.24–1.74 kPa)					For 3.5–5 in Water Column (0.87–1.24 kPa)				
	Allowable Pipe Distances (ft/m)									
	0.5/13	0.75/19	1/25	1.25/32	1.5/38	0.75/19	1/25	1.25/32	1.5/38	
10 kW	10/3.1	60/18.3	200/61	750/228.6	—	20/6.1	60/18.3	175/53.3	—	
14/18 kW	—	10/3.1	55/16.7	200/60.9	450/137.1	—	30/9.1	125/38.1	200/61	
20 kW	—	10/3.1	35/10.7	140/42.3	300/91.4	—	10/3.1	60/18.3	125/38.1	
22–26 kW	—	10/3.1	30/9.1	115/35.1	250/76.2	—	10/3.1	60/18.3	125/38.1	

LP Gas Pipe Sizing

To determine correct LP gas pipe size, find the kW rating of generator in the left column, and trace to the right. The number to the right is maximum length (measured in ft / m) allowed for pipe sizes on top. Pipe sizes are measured by trade size diameter to include any fittings, valves (must be full flow), elbows, tees, or angles. See Table B.3.2 in NFPA 54 or Table A.2.2 in the ICC IFGC, Equivalent Lengths of Pipe Fittings and Valves for the correct values to be added to overall fuel piping length.

NOTE: Pipe sizes are from the outlet of the second stage regulator to the fuel shutoff valve. Table is based on schedule 40 black pipe. If installing any other piping system, follow the pipe size charts for the selected piping system.

NOTE: Recommended minimum LP tank size is 250 gal (946 L). Contact LP provider to correctly size LP tank to generator. Vertical tanks, which are measured in pounds (or kilograms), are permitted if correctly sized for the generator. Do not connect generator to a 20 or 30 lbs LP tank.

Table 5-2. LP Gas Pipe Sizing

Pipe Size (in / mm)	For 10–12 in Water Column (2.49–2.99 kPa)			
	Allowable Pipe Distances (ft/m)			
	0.5/13	0.75/19	1/25	1.25/32
10 kW	30/9.1	175/53.3	400/121.9	—
14/18 kW	—	80/24.4	350/106.7	600/182.9
20–26 kW	—	40/12.2	175/53.3	550/167.6

Installing and Connecting Fuel Lines



▲ DANGER

Explosion and fire. Fuel and vapors are extremely flammable and explosive. No leakage of fuel is permitted. Keep fire and spark away. Failure to do so will result in death or serious injury. (000192)

IMPORTANT NOTE: NG and LP gas are highly volatile substances. Strictly adhere to all safety procedures, codes, standards, and regulations.

Fuel line connections should be made by a certified contractor familiar with local codes. Always use AGA-approved gas pipe and a quality pipe sealant or joint compound.

Verify capacity of NG meter or LP tank to provide sufficient fuel for both the generator and other operating appliances.

Fuel Shutoff Valve

See [Figure 5-2](#). The generator will require an external manual fuel shutoff valve (A) on the fuel line.

NOTE: Fuel shutoff valve must be installed at a readily accessible location, and within 6 ft (1.8 m) of generator fuel inlet.

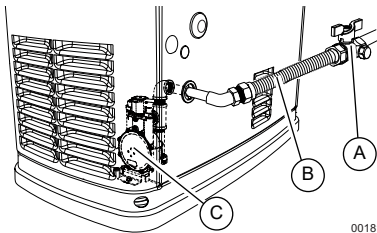

001816

Figure 5-2. Sediment Trap, Fuel Shutoff Valve with Manometer Port, and Flexible Fuel Line

[Figure 5-3](#) illustrates a fuel shutoff valve with a manometer port for making fuel pressure checks. This optional accessory fuel shutoff valve permits making pressure checks for diagnostic purposes without going into the generator enclosure.

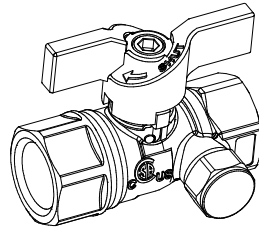

000743

Figure 5-3. Fuel Shutoff Valve with Manometer Port

Fuel shutoff valves available through an IASD:

- 1/2 in ball valve, part number 0K8752
- 3/4 in ball valve, part number 0K8754
- 1 in ball valve, part number 0K8184
- 1-1/4 in ball valve, part number 0L2844
- 1-1/2 in ball valve, part number 0L2845

Flexible Fuel Line

See [Figure 5-2](#). When connecting flexible fuel line (B) to generator, use a listed assembly meeting the requirements of ANSI Z21.75/CSA 6.27—Connectors for Outdoor Gas Appliances and Manufactured Homes or AGA-approved flexible fuel line in accordance with local regulations.

Flexible fuel line must not be connected directly to generator fuel inlet. Always connect flexible fuel line to an approved gas fitting.

The purpose of flexible fuel line is to isolate vibration from the generator to reduce possibility of a gas leak at one of the connection points. Installation of a flexible fuel line is a fuel gas code and installation requirement.

NOTE: Follow all installation instructions and warnings provided with the flexible fuel line. Do not remove any labels or tags. Flexible fuel line must be installed horizontally, and must be installed between fuel shutoff valve and generator fuel inlet.

Sediment Trap

See [Figure 5-2](#). Some local codes require a sediment trap (C). The fuel regulator connection has an integrated sediment trap.

The sediment trap must be cleaned periodically according to local codes. See owner's manual for more information.

Checking Fuel Line Connections

Checking Fuel Pressure

Proceed as follows to check fuel pressure at fuel regulator in the generator.

1. Close fuel supply valve.
2. See [Figure 5-4](#). Remove top fuel pressure test port from fuel regulator and install fuel pressure tester (manometer).

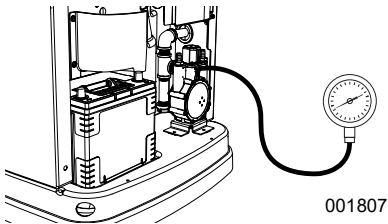

Figure 5-4. Checking Pressure with Manometer

3. Open fuel supply valve and verify fuel pressure is within specified values.
4. Record static fuel pressure: _____

NOTE: Fuel pressure can also be tested at manometer port on fuel shutoff valve shown in [Figure 5-2](#).

NOTE: See fuel data decal or spec sheet for correct fuel pressure specifications. Contact local fuel supplier if fuel pressure is not within specifications.

5. Close fuel supply valve when completed. Keep manometer connected for future tests of generator while starting, running, and under loads.

Performing Fuel System Leak Test



▲ DANGER

Explosion and fire. Fuel and vapors are extremely flammable and explosive. No leakage of fuel is permitted. Keep fire and spark away. Failure to do so will result in death or serious injury. (000192)

All products are factory-tested before shipping to verify the performance and integrity of the fuel system. However, it is important to perform a final fuel system leak test before starting the generator. The entire fuel system should be tested from supply to regulator.

See [Figure 5-5](#). Perform a final fuel system leak test after generator installation. The test will identify possible leaks at all connection points (A).

It is best practice to perform a fuel system leak test during normally-scheduled maintenance.

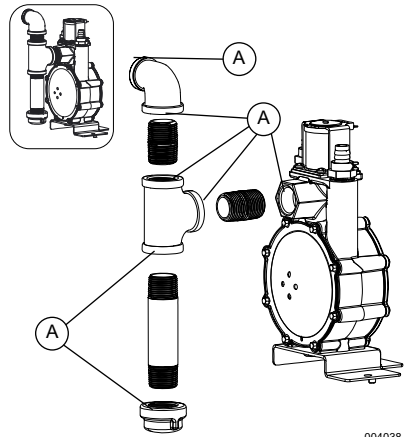
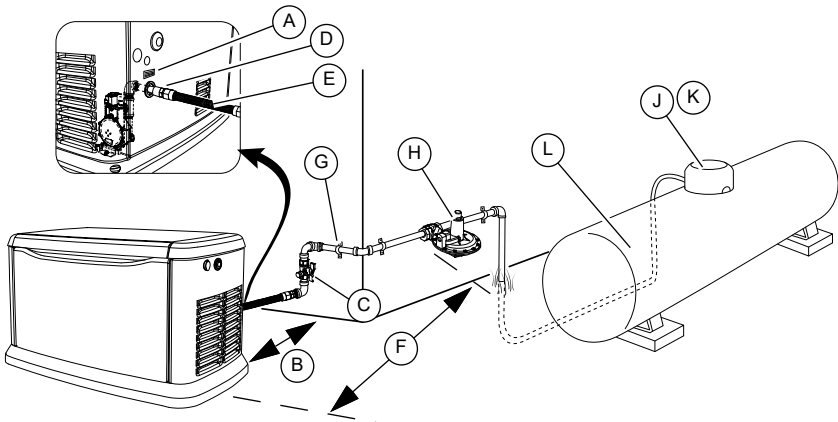

Figure 5-5. Connection Points to Leak Check

Inspect for leaks by spraying all connection points with a non-corrosive gas leak detection fluid. The solution should not be blown away or form bubbles.

LP Gas (Vapor) Installation (Typical)



008966

LPG BTU/h = ft ³ /h X 2500	Megajoules/h = m ³ /h X 93.15
A	Fuel data decal
B	Minimum distance from rear obstruction—see Distance Requirements
C	Manual fuel shutoff valve (pressure port optional) Must be located no more than 6 ft (1.83 m) away from fuel inlet.
D	Pipe fittings (field supplied)
E	Flexible fuel line
F	Verify minimum distance requirements for regulator vent according to local gas codes. Regulator should be a minimum of 5 ft (1.5 m) from generator. Local codes and regulator manufacturer may have further clearance requirements.
G	Clamp
H	Secondary fuel pressure regulator
J	Manual shutoff valve
K	Primary fuel pressure regulator
L	Fuel tank—sized large enough to provide required MJ/BTU for generator operating at FULL load and ALL connected appliance loads. Be sure to correct for weather evaporation.

Figure 5-7. LP Gas (Vapor) Installation (typical)

This page intentionally left blank.

Section 6: Electrical Connections

Generator Connections

See [Figure 6-1](#). The electrical wiring enclosure is located behind an access panel on intake end of unit. Remove intake side panel as directed in [Intake Side Panel Removal](#), and then remove access panel. Connect wires according to diagram and tables.

1. Remove main AC / control wiring knock-out plugs from back of generator.
2. Using appropriate wiring hole, install conduit and main AC and control wires between generator and transfer switch.
3. Close unused hole with a NEMA 3R rated plug (field-supplied).

NOTE: All conductors must be rated for minimum 300V. Control system interconnections may consist of N1, N2, T1, leads 23 and 194, and NEU/00. All of the generator control wiring circuits are Class 1 remote control or signaling circuits. These circuits are required to be installed in accordance with Part 1 of NEC Article 300 and with a NEC recognized Chapter 3 wiring method. The use of low voltage cables for the generator control circuit wiring is prohibited. See instruction manual of the specific engine generator for wiring connection details. Recommended wire gauge sizes for this wiring depends on wire length, as recommended in [Table 6-3](#).

Exception: Conductors of AC and DC circuits, rated 1000 volts nominal or less, shall be permitted to occupy the same equipment, cable, or conduit. All conductors shall have an insulation rating equal to at least the maximum circuit voltage applied to any conductor within the equipment, cable, or conduit. See NEC 300.3(C)(1).

4. See [Figure 6-1](#). Strip insulation from wire ends. Do not remove excessive insulation. Route sense wires through supplied wire tie (C1), and connect to sense wire terminal block (B). Push down on spring loaded connection point with a flat head screwdriver, insert wire, and release.
5. Using the same process, route control wires through second supplied wire tie (C2), and connect to control wire terminal block (A).
6. When all wires are securely connected to correct terminals, tighten wire ties and clip excess length.

NOTE: Only bare wire should be inserted into each terminal. Do not insert any wire insulation into terminals.

NOTE: Damage caused by mis-wiring of the interconnect wires is not warrantable.

Control Wiring

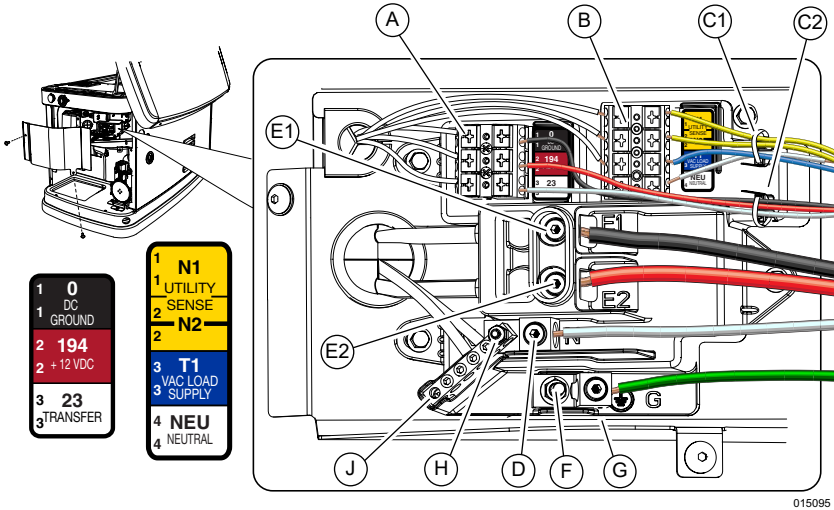

Figure 6-1. Electrical Wiring Connections

015095

Table 6-1. Electrical Wiring Connection Points

ID	Description	ID	Description	ID	Description
A	Control wire terminal block	D	Neutral lug	G	Ground lug
B	Sense wire terminal block	E1	Power lug E1	H	Neutral stud
C1	Wire tie for sense wires	E2	Power lug E2	J	Neutral bar
C2	Wire tie for control wires	F	Ground stud	—	—

Table 6-2. Customer Wiring Connections

Terminal No. Decal	Wire Numbers
YELLOW	N1 & N2 - 240 VAC - Sensing for utility dropout and pickup
BLUE *	T1 - Fused 120 VAC for battery charger
WHITE *	NEU/00 - Neutral for battery charger
BLACK **	0 - DC (-) Common ground wire
RED	194 - DC (+) 12 VDC for transfer controls
WHITE	23 - Transfer control signal wire

Table 6-3. Control Wire Recommended Length and Size (Copper Conductors Only)

Maximum Wire Length	Recommended Wire Size
1–115 ft (0.3–35 m)	No. 18 AWG
115–185 ft (35–56 m)	No. 16 AWG
185–295 ft (56–89 m)	No. 14 AWG
295–460 ft (89–140 m)	No. 12 AWG

* Must be connected to keep battery charged whether unit is running or not.

** Required if generator is paired with optional Digital Power Management (DPM) smart technology.

Table 6-4. Ground and Neutral Connections (Copper or Aluminum Conductors)			
See national and/or local codes to verify correct wire sizes.			
#	Description	Recommended Wire Size	Torque Spec
1	Power wire terminals	2/0 to 8 AWG	120 in-lbs (13.56 Nm)
2	Large neutral lug	2/0 to 14 AWG	120 in-lbs (13.56 Nm)
3	Large ground lug	2/0 to 14 AWG	120 in-lbs (13.56 Nm)
4	Neutral bus bar	4-6 AWG	35 in-lbs (3.95 Nm)
		8 AWG	25 in-lbs (2.82 Nm)
		10-14 AWG	20 in-lbs (2.26 Nm)

Main AC Wiring

NOTE: Main AC wiring must be in accordance with local jurisdiction and codes.

NOTE: Raceway connections to the generator must be flexible. Ridged raceway connections to the generator are only permitted where approved expansion fittings are installed.

NOTE: If used, splices must be rated for minimum 167 °F (75 °C) (copper or aluminum).

NOTE: Generator lugs are rated at 167 °F (75 °C), copper or aluminum.

- Strip insulation off wire ends. Do not remove excessive insulation.
- See [Figure 6-1](#). Loosen lugs at neutral (D), ground (G), and power wire (mains) terminals (E1, E2).
- Connect ground wire to ground lug and tighten to required specification. See [Table 6-4](#).
- Connect neutral wire to neutral lug, if applicable. Tighten to required specification. See [Table 6-4](#).
- Insert power wires (E1 and E2) into their corresponding lugs. Tighten to required specification.
- Verify factory-installed ground array and neutral connections are correctly tightened to 25 **in-lbs** (2.82 Nm).

NOTE: Neutral wire must remain connected to keep battery charged whether generator is running or not.

NOTE: Neutral bonding – For installations requiring neutral to be bonded to ground, this is done on the customer connections terminals inside generator.

See [Figure 6-1](#). Connect a suitably sized system bonding jumper in accordance with NEC Table 250.102(C)(1) from neutral bar (J) to ground stud (F). Tighten ground stud nut to 35 **in-lbs** (3.95 Nm). This is required when generator is installed as a separately derived system. Generator will also require a connection to a grounding electrode system in accordance with NEC Article 250.64. It is not required when generator is a backup source in a utility supplied electrical system with a 2-pole transfer switch. Installation must be made in accordance with NEC Articles 250.30 and 250.35(A) if generator will be installed as a separately derived system.

NOTE: Tighten all wiring lugs, bus bars, and connection points to required torque specifications.

Conductors of AC and DC circuits, rated 1,000 volts nominal or less, shall be permitted to occupy the same equipment, cable, or conduit. All conductors must have an insulation rating equal to at least the maximum circuit voltage applied to any conductor within the equipment, cable, or conduit. See NEC 300.3(C)(1).

Service Entrance Decals

See [Figure 2-10](#). Locate service entrance-related decals in the loose parts bag.

- Place service disconnect decal next to generator MLCB (generator disconnect) (if required by local codes).
- Place service entrance warning decal in an appropriate location according to instructions printed on the decal.

Common Alarm Relay (Option)

Alarms relating to generator and engine performance appear on the controller and in the Mobile Link® application (if used). The controller is equipped with a common alarm relay, providing contacts for an optional customer-supplied external alarm indicator.

The common alarm relay is normally open until an alarm occurs, triggering relay to close contacts.

Terminals for common alarm relay are provided in the wiring harness near the controller plug (Wires 209 and 210).

Contact rating is for resistive load only:

Contact rating	200 mA at 12 VDC
----------------	------------------

Battery Requirements

12 volts, Group 26R Wet Cell 540CCA minimum, or Group 35 AGM 650CCA minimum. Recommended part number 0H3421S.

NOTE: Do not use external battery chargers.

Battery Installation



⚠️ WARNING

Explosion. Batteries emit explosive gases while charging. Keep fire and spark away. Wear protective gear when working with batteries. Failure to do so could result in death or serious injury.

(000137a)



⚠️ WARNING

Risk of burns. Batteries contain sulfuric acid and can cause severe chemical burns. Wear protective gear when working with batteries. Failure to do so could result in death or serious injury.

(000138a)



⚠️ WARNING

Explosion. Batteries emit explosive gases. Always connect positive battery cable first to avoid spark. Failure to do so could result in death or serious injury.

(000133)



⚠️ WARNING

Risk of burn. Do not open or mutilate batteries. Batteries contain electrolyte solution which can cause burns and blindness. If electrolyte contacts skin or eyes, flush with water and seek immediate medical attention.

(000163a)

- **(Unsealed 26R batteries only):** Fill battery with the correct electrolyte fluid, if necessary.

- Fully charge battery before installing it.

Complete the following steps before installing and connecting battery:

1. Verify generator is OFF.
2. Turn off utility power supply to transfer switch.
3. Remove 7.5A fuse from generator control panel.

Connecting the Battery



⚠️ WARNING

Explosion. Batteries emit explosive gases. Always connect positive battery cable first to avoid spark. Failure to do so could result in death or serious injury.

(000133)



⚠️ CAUTION

Equipment damage. Do not make battery connections in reverse. Doing so will result in equipment damage.

(000167a)

See [Figure 6-2](#). Battery cables (A, B) were factory connected at the generator.

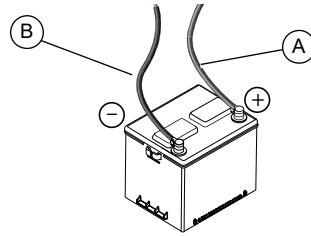

0001832

Figure 6-2. Battery Cable Connections

Proceed as follows to connect battery cables to battery posts:

1. Connect red positive battery cable (A: from starter contactor) to positive battery post. Tighten to 70 **in-lbs** (8 Nm).
2. Connect black negative battery cable (B: from frame ground) to negative battery post. Tighten to 70 **in-lbs** (8 Nm).
3. Install red battery post cover (shipped with loose parts).

NOTE: Apply dielectric grease to battery posts to prevent corrosion.

NOTE: In areas where temperatures fall below 0 °F (-18 °C), a pad type battery warmer is recommended to aid in cold climate starting. The battery warmer is available as part of a cold weather kit (PN: G007101-0) from any IASD.

NOTE: A battery warmer is not necessary for AGM-style batteries.

Battery Disposal

⚠️ WARNING

Environmental Hazard. Always recycle batteries at an official recycling center in accordance with all local laws and regulations. Failure to do so could result in environmental damage, death, or serious injury. (000228)

Always recycle batteries in accordance with local laws and regulations. Contact your local solid waste collection site or recycling facility to obtain information on local recycling processes. For more information on battery recycling, visit the Battery Council International website at: <http://batteryCouncil.org>.

Section 7: Control Panel Startup / Testing

Control Panel Interface

The control panel interface is located under the enclosure lid. Verify both left and right side locks are unlocked before attempting to lift enclosure lid. Open lid as directed in [Opening the Lid](#).

Using the AUTO/OFF/MANUAL Buttons

Button	Description of Operation
AUTO	Activates fully automatic system operation. Automatic operation allows unit to automatically start and exercise generator according to exercise timer settings (see Setting The Exercise Timer).
OFF	Shuts down engine and also prevents automatic operation and exercise of unit.
MANUAL	Cranks and starts generator. Transfer to standby power will not occur unless there is a utility failure.

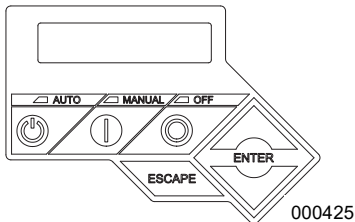

Figure 7-1. Generator Control Panel

Generator Setup

The controller illuminates when battery power is applied to generator during the installation process. Generator must be activated before it will automatically run in the event of a power outage.

Activation

To activate the generator, go to www.activategen.com and follow the instructions.

Activation is a simple, one-time process. The generator will not prompt to activate again once the unit is activated, even if the generator battery, fuse, and battery charge circuit (T1) are disconnected.

NOTE: The generator must be connected to the home Wi-Fi network for automatic authentication to be completed successfully. See Wi-Fi manual for more information.

NOTE: If home Wi-Fi network is not available, follow instructions on www.activategen.com.

Proceed as follows after activating generator on-line:

1. The display interface will launch Install Wizard upon first power-up of the generator.
2. Follow on-screen instructions on the generator along with Quick Start Guide supplied with the unit to connect generator to home Wi-Fi network.
3. Wait for on-line authentication of generator activation through connected home Wi-Fi network.
4. Follow on-screen instructions to complete the Install Wizard.

NOTE: See [Figure 7-2](#). If generator screen shows message shown below, press ESC and then ENTER to reset to Install Wizard.

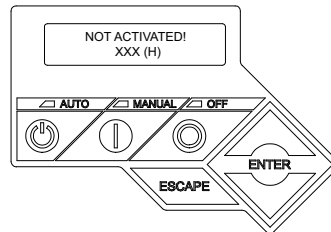
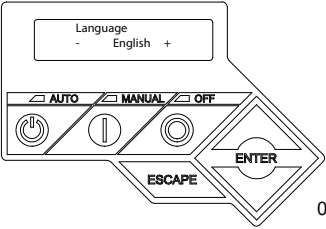
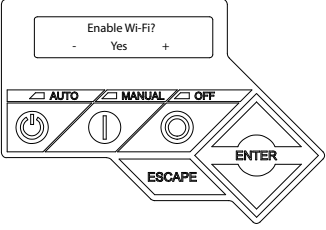
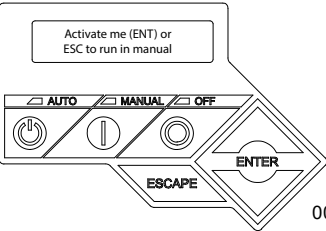
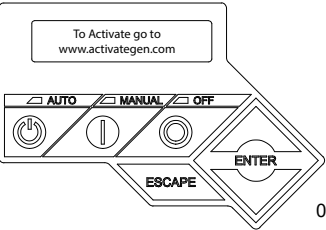
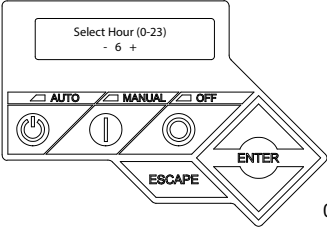

Figure 7-2. Not Activated Screen

NOTE: Generator can only be placed in AUTO mode after completing activation process.

IMPORTANT NOTE: Fuel selector knob must be set to the correct fuel for generator to function correctly.

Display Reads		Troubleshooting
 <p>002227</p>	<p>Use arrow keys to scroll to desired language. Press ENTER to select.</p>	<p>Language can be changed later using the EDIT menu.</p>
 <p>004498</p>	<p>Use arrow keys to either enable or disable Wi-Fi. If YES, see Wi-Fi manual. If NO, continue.</p>	
 <p>002228</p>	<p>Press ENTER to begin activation process.</p>	<p>If ESCAPE is pressed instead of ENTER, generator will only run in manual mode (for test purposes) and NOT ACTIVATED will be displayed. Press ESC and then ENTER to reset Install Wizard.</p>
 <p>002229</p>	<p>If unit has not been activated, go to www.activategen.com. If unit has been activated, press ESC and then ENTER.</p>	

Display Reads		Troubleshooting
	<p>Activation is complete when this screen is displayed. Follow controller prompts to complete installation.</p>	

Cold Smart Start

The Cold Smart Start feature is factory-enabled, and can be disabled in the EDIT menu. Generator will monitor ambient temperature and adjust its warm-up delay accordingly when Cold Smart Start is enabled. If ambient temperature is below a fixed temperature upon startup in AUTO mode (per chart below), generator will warm up for 30 seconds, allowing engine to warm before load is applied. If ambient temperature is at or above fixed temperature, generator will start up with normal warm-up delay of six seconds. See Cold Smart Start section in owner’s manual.

Generator Size	10–20 kW	22-26 kW
Fixed Temperature	50 °F (10 °C)	20 °F (-7 °C)

Setting The Exercise Timer

This generator is equipped with a configurable exercise timer. There are two settings for the exercise timer:

- **Day/Time:** Generator will start and exercise for period defined, on day of week and at time of day specified. During this exercise period, unit runs for five minutes on all models, and then shuts down.
- **Exercise frequency (how often exercise will take place):** Can be set to Weekly, Biweekly, or Monthly. If Monthly is selected, day of the month must be selected from 1–28. Generator will exercise on that day each month. Transfer of loads to generator output does not occur during exercise cycle unless utility power is lost.

NOTE: If installer tests generator prior to installation, press ENTER button to skip setting up exercise timer.

NOTE: The exercise feature will operate only when generator is placed in AUTO mode, and will not work unless this procedure is performed. If Wi-Fi is **not** enabled, current date/time must be reset every time power is removed from controller via the controller fuse and T1 circuit and/or battery connections.

NOTE: If Wi-Fi is enabled, exercise timer will automatically adjust for Daylight Saving Time.

NOTE: If using Wi-Fi feature, exercise time will be set to a random weekday during daylight hours. This setting can be changed later. See Wi-Fi manual for details.

Before Initial Startup

CAUTION

Engine damage. Verify proper type and quantity of engine oil prior to starting engine. Failure to do so could result in engine damage.

(000135)

NOTE: The unit comes filled with 5W-30 weight organic oil from the factory. Check oil level and add appropriate viscosity and amount of oil if necessary.

After the 25 hour break-in period, it is recommended to use Generac’s proprietary 5W-20 gaseous engine oil (GEO) for continuous use. It is specifically formulated for use in gaseous powered Generac generators.

Install Wizard

See **Figure 7-3**. The Install Wizard immediately appears upon initial startup. It allows user to input generator settings.

The Install Wizard starts every time AC and DC power are removed and reapplied to generator.

Interconnect System Self Test Feature

This controller goes through a system self test at startup, which checks for utility voltage on DC circuits. This test prevents damage if installer incorrectly connected AC utility power sense wires into the DC terminal block. The controller will display a warning message and lock out the generator if utility voltage is detected at the DC terminal block, preventing damage to the controller. Power to controller must be removed to clear this warning.

Utility voltage must be turned on and present at the N1 and N2 terminals inside the generator control panel for this test to be performed and pass.

NOTE: All appropriate panels must be in place during any operation of generator. This includes operation by a servicing technician, while conducting troubleshooting procedures.

Before starting, complete the following:

1. Verify generator is OFF.
2. Set generator MLCB (generator disconnect) to OFF (OPEN).
3. Turn OFF all breakers to be supplied by generator.
4. Verify emergency shutdown switch(es) are CLOSED (I).
5. Check engine crankcase oil level and, if necessary, fill to oil dipstick FULL mark with recommended oil. Do not overfill.
6. Inspect fuel supply. Gaseous fuel lines must have been correctly purged and leak tested in accordance with applicable fuel-gas codes. All fuel shutoff valves in the fuel supply lines must be open.

During initial startup only, generator may exceed normal number of start attempts and experience an "OVERCRANK" fault. This is due to accumulated air in the fuel system during installation. Reset control board by pressing OFF mode button and ENTER button, and restart up to two more times if necessary. If unit fails to start, contact an IASD for assistance.

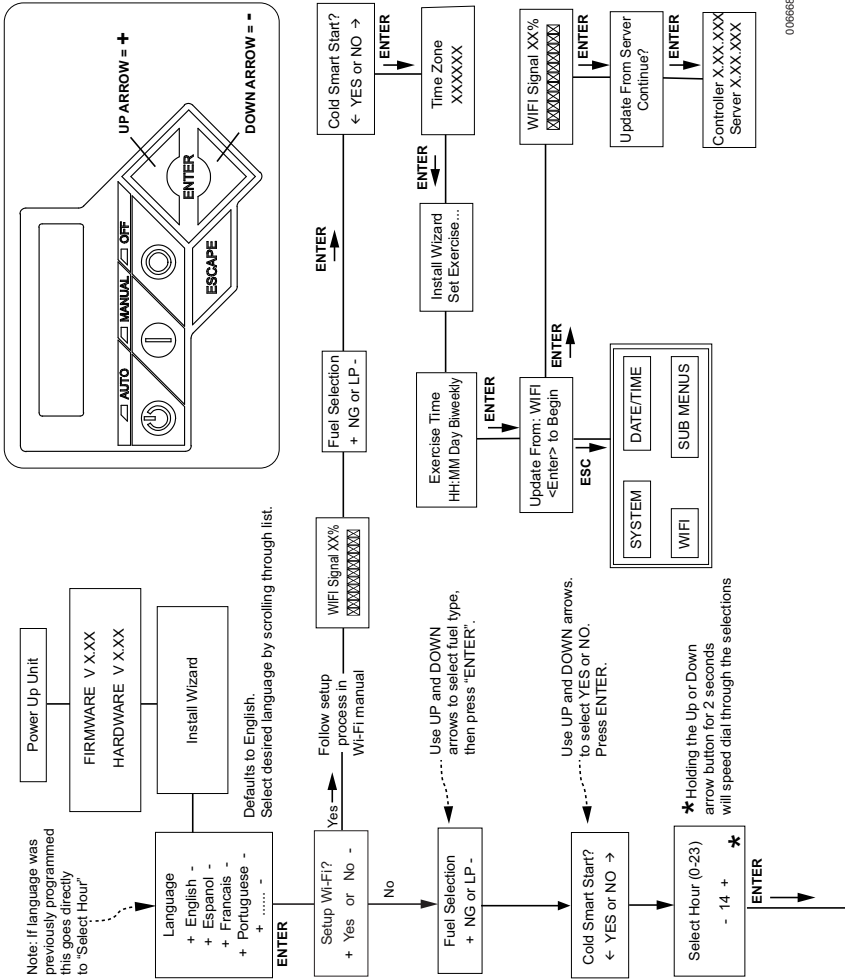

0.06688

Figure 7-3. Install Wizard Menu Map

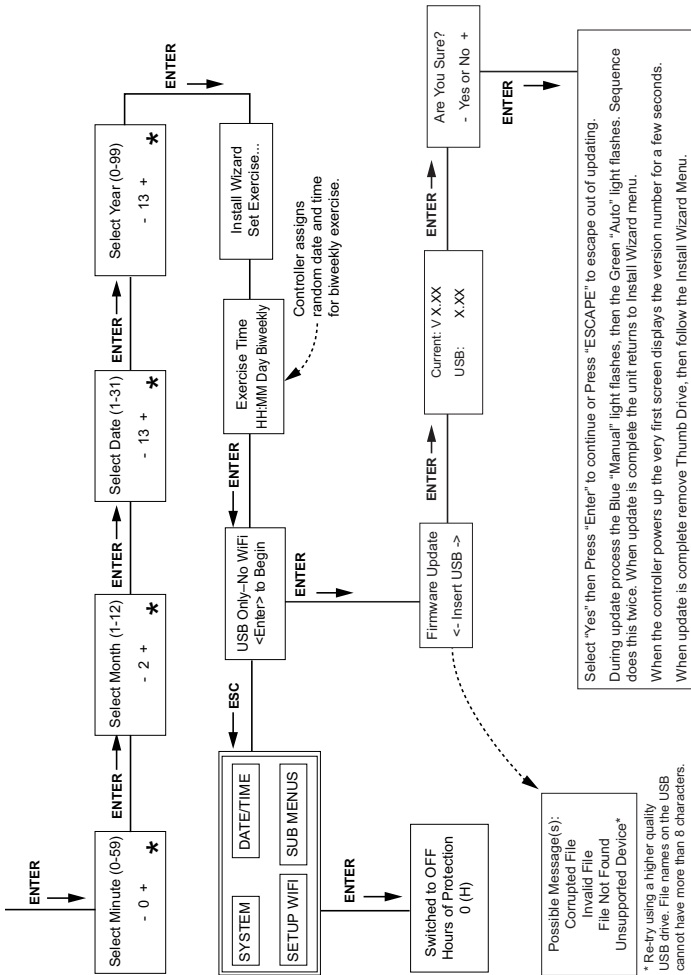

Figure 7-4. Install Wizard Menu Map

Checking Manual Transfer Switch Operation



▲ DANGER

Electrocution. High voltage is present at transfer switch and terminals. Contact with live terminals will result in death or serious injury.

(000129)

See Manual Transfer Operation section of owner's manual for procedures.

Electrical Checks



▲ DANGER

Electrocution. High voltage is present at transfer switch and terminals. Contact with live terminals will result in death or serious injury.

(000129)

Proceed as follows to complete electrical checks:

1. Verify generator is in OFF mode.
2. Set generator MLCB (generator disconnect) to OFF (OPEN).
3. Turn off all circuit breakers/electrical loads to be supplied by generator.
4. Turn on utility power supply to transfer switch using means provided (such as a utility MLCB).
5. Use a calibrated AC voltmeter to verify utility power source voltage across transfer switch terminals N1 and N2. Nominal line-to-line voltage should be 240 volts AC. If voltage is incorrect, verify AC output and wiring from utility source to N1 and N2 lugs at transfer switch.
6. Verify utility power source voltage across terminals N1 and transfer switch neutral lug; then across terminal N2 and neutral. Nominal line-to-neutral voltage should be 120 volts AC (if wired with a neutral). If voltage is incorrect, verify AC output and wiring from utility source to N1 and N2 lugs at transfer switch.
7. Turn off utility power supply to transfer switch when utility supply voltage is verified to meet specification provided in Step 6.
8. Press MANUAL mode button on generator panel. The engine will crank and start. Record cranking fuel pressure: _____.
9. Allow engine to warm up for approximately five minutes for internal temperatures to stabilize. Then set generator MLCB (generator disconnect) to ON (CLOSED). Record running fuel pressure: _____.

10. Connect a calibrated accurate AC voltmeter and a frequency meter across transfer switch terminal lugs E1 and E2. Voltage should be 238–242V at a frequency of 59.5–60.5 Hz. If voltage is incorrect, verify generator MLCB (generator disconnect) is closed, and verify AC output and frequency (Hertz or Hz) at generator MLCB (generator disconnect). Verify wiring from generator to E1 and E2 lugs at transfer switch.
11. Connect AC voltmeter test leads across terminal lugs E1 and neutral, then across E2 and neutral (if wired with a neutral). In both cases, voltage reading should be 119–121 volts AC. If voltage is incorrect, verify generator MLCB (generator disconnect) is closed, and verify AC output between E1 and E2 of generator MLCB (generator disconnect) and neutral at generator.
12. Verify wiring from generator to E1, E2, and neutral lugs at transfer switch.
13. Set generator MLCB (generator disconnect) to OFF (OPEN).
14. Press generator OFF mode button. The engine will shut down.

IMPORTANT NOTE: DO NOT proceed until generator AC voltage and frequency are correct and within stated limits.

Generator Tests Under Load



▲ DANGER

Electrocution. Do not manually transfer under load. Disconnect transfer switch from all power sources prior to manual transfer. Failure to do so will result in death or serious injury, and equipment damage.

(000132)

Proceed as follows to test generator with electrical loads applied:

1. Verify generator is in OFF mode.
2. Set generator MLCB (generator disconnect) to OFF (OPEN).
3. Turn off all circuit breakers/electrical loads to be supplied by generator.
4. Turn off utility power supply to transfer switch using means provided (such as a utility MLCB).
5. Manually set transfer switch to STANDBY, with load terminals connected to generator's E1/E2 terminals. Transfer switch operating lever should be down.
6. Press generator MANUAL button. Engine will crank and start immediately.
7. Verify fuel pressure while cranking. Record cranking fuel pressure: _____.
8. Allow engine to stabilize and warm up for a few minutes.

9. Verify fuel pressure while running. Record running fuel pressure: _____
10. Set generator MLCB (generator disconnect) to ON (CLOSED). Loads are now powered by standby generator.
11. Turn on circuit breakers/electrical loads to be supplied by generator one by one.
12. Connect a calibrated AC voltmeter and a frequency meter across terminal lugs E1 and E2. Voltage should be approximately 240 volts and frequency should be approximately 60 Hz. If voltage and frequency are rapidly dropping as loads are applied, generator may be overloading, or there may be a fuel issue. Verify output current measurement of loads and/or fuel pressure.
13. Allow generator to run at full rated load for 20–30 minutes. Listen for unusual noises, vibration, or other indications of abnormal operation. Inspect for oil leaks, evidence of overheating, etc.
14. Verify fuel pressure while under full load. Record loaded fuel pressure: _____
15. Turn off circuit breakers/electrical loads when testing under load is complete.
16. Set generator MLCB (generator disconnect) to OFF (OPEN).
17. Allow engine to run at no-load for 2–5 minutes.
18. Press generator OFF button. Engine will shut down.

NOTE: If fuel pressure under full load is below minimum operating fuel pressure guideline, generator may not function correctly. The fuel pressure gauge needle should also remain steady while testing. A fluctuating fuel pressure gauge needle indicates gas piping may be undersized or restricted. It may also indicate a step-down gas regulator is too small, or too close to unit.

Checking Automatic Operation

Proceed as follows to check system for correct automatic operation:

1. Verify generator is OFF.
2. Install front cover of transfer switch.
3. Turn on utility power supply to transfer switch using the means provided (such as a utility MLCB).

NOTE: Transfer switch will transfer to utility position.

4. Set generator MLCB (generator disconnect) to ON (CLOSED).
5. Press generator AUTO button. The system is now ready for automatic operation.

6. Turn off utility power supply to transfer switch.

The generator is ready for automatic operation. The engine will crank and start when utility source power is turned off after a five second delay (factory default setting). After starting, transfer switch will connect load circuits to the standby side after a 5 or 30 second delay (dealer programmable). See **Cold Smart Start**. Allow system to operate through entire automatic sequence of operation.

With generator running and loads powered by generator AC output, turn on utility power supply to transfer switch. The following will occur:

- After approximately 15 seconds (dealer programmable), the transfer switch will transfer loads to the utility power source.
- Approximately one minute after transfer, engine will shut down.

Installation Summary

1. Verify installation has been performed correctly as outlined by the manufacturer and that it meets all applicable laws and codes.
2. Test and verify correct operation of the system as outlined in the appropriate installation and owner's manuals.
3. Educate end-user on correct operation, maintenance, and service call procedures.

Shutting Generator Down While Under Load or During a Utility Outage

DANGER

Automatic start-up. Disconnect utility power and render unit inoperable before working on unit. Failure to do so will result in death or serious injury.

(000191)

IMPORTANT NOTE: To avoid equipment damage, follow these steps, in order, during utility outages. Shutdowns may be required during utility outages to perform routine maintenance or to conserve fuel.

To turn generator OFF:

1. Set utility MLCB to OFF (OPEN).
2. Set generator MLCB (generator disconnect) to OFF (OPEN).
3. Allow generator to run for cool-down for approximately one minute.
4. Set generator to OFF at the controller.
5. Remove 7.5A fuse from controller.

To turn generator back ON:

1. Install 7.5A fuse in controller.

2. Verify generator MLCB (generator disconnect) is OFF (OPEN).
3. Set generator to AUTO mode at the controller.
4. Generator will start and run. Allow generator to run and warm up for a few minutes.
5. Set generator MLCB (generator disconnect) to ON (CLOSED).
6. Set utility MLCB to ON (CLOSED).

The system now operates in automatic mode.

Section 8: Troubleshooting

Generator Troubleshooting

Problem	Cause	Correction
Engine will not crank	Blown fuse.	Correct short circuit condition by replacing 7.5A fuse in generator control panel. Contact an IASD if fuse continues to blow.
	Loose, corroded, or faulty battery cables.	Tighten, clean, or replace as necessary.*
	Faulty starter contact.	
	Faulty starter motor.	
	Discharged battery.	Charge or replace battery.
Engine cranks but will not start	No fuel.	Replenish fuel / turn on fuel shutoff valve.
	High fuel pressure.	Check and adjust fuel pressure.
	Fuel selector in wrong position.	Set fuel conversion valve to correct position and program controller for fuel type, if necessary.
	Faulty fuel solenoid (FS).	Contact an IASD for assistance.
	Harness/wiring issue.	
	Faulty spark plug(s).	Replace spark plug(s).
Valve clearance out of adjustment. (If applicable. See Specification section in owner's manual.)	Inspect and adjust valve clearance.	
Engine starts hard and runs rough	Plugged or damaged air cleaner.	Inspect and clean or replace air cleaner.
	Faulty spark plug(s).	Replace spark plug(s).
	Incorrect fuel pressure.	Verify fuel pressure to fuel regulator is 10–12 in water column (2.49–2.99 kPa) for LP, and 3.5–7.0 in water column (0.87–1.74 kPa) for NG.
	Fuel selector in wrong position.	Set fuel conversion valve to correct position and program controller for fuel type, if necessary.
	Valve clearance out of adjustment. (If applicable. See Specification section in owner's manual.)	Inspect and adjust valve clearance.
	Internal engine issue.	Contact an IASD for assistance.

Problem	Cause	Correction
Unit is set to OFF, but engine continues to run	Controller wired incorrectly.	Contact an IASD for assistance.
	Faulty control board.	
No AC output from generator	Generator MLCB (generator disconnect) is OFF (OPEN).	Set generator MLCB (generator disconnect) to ON (CLOSED).
	Generator internal failure.	Contact an IASD for assistance.
	Engine may be warming up. See Cold Smart Start .	Check controller screen to verify status.
No transfer to standby after utility source failure	Generator MLCB (generator disconnect) is OFF (OPEN).	Set generator MLCB (generator disconnect) to ON (CLOSED).
	Faulty transfer switch coil.	Contact an IASD for assistance
	Faulty transfer relay.	
	Transfer relay circuit open.	
	Faulty control logic board.	Check controller screen to verify status.
Engine may be warming up. See Cold Smart Start .		
Unit consumes large amounts of oil	Excessive engine oil.	Adjust oil to correct level. See checking engine oil level section in owner's manual.
	Faulty engine breather.	Contact an IASD for assistance
	Incorrect type or viscosity of oil.	See engine oil requirements in owner's manual.
	Damaged gasket, seal, or hose.	Inspect for oil leaks.
	Restricted air filter.	Replace air filter.
Wi-Fi network connection broken or intermittent	Various.	See Wi-Fi module owner's manual.
* Contact an IASD or visit www.generac.com for assistance.		

NOTE: IASD must have an active Tech ID and be air-cooled certified to perform any warrantable repairs and submit warranty claims related to air-cooled products.

Section 9: Quick Reference Guide

System Diagnosis

To clear an active alarm, press ENTER button twice and then press AUTO. If alarm reoccurs, contact an air-cooled certified IASD.

Active Alarm	LED	Problem	Action	Solution
NONE	FLASHING GREEN	Unit running in AUTO but no power in house.	Check generator MLCB (generator disconnect).	Check generator MLCB (generator disconnect). If it is ON, contact an IASD.
HIGH TEMPERATURE	RED	Unit shuts down during operation.	Check LED's / Screen for alarms.	Inspect ventilation around generator, intake, exhaust, and rear of generator. If no obstructions are present, contact an IASD.
OVERLOAD REMOVE LOAD	RED	Unit shuts down during operation.	Check LED's / Screen for alarms.	Clear alarm and remove household loads from generator. Put back in AUTO and restart.
RPM SENSE LOSS	RED	Unit was running and shuts down, attempts to restart.	Check LED's / Screen for alarms.	Clear alarm and remove household loads from generator. Put back in AUTO and restart. If generator does not start, contact an IASD.
NOT ACTIVATED	NONE	Unit will not start in AUTO with utility loss.	Verify if screen says unit not activated.	See Activation .
NONE	GREEN	Unit will not start in AUTO with utility loss.	Check screen for start delay countdown.	If startup delay is greater than expected, contact an IASD to adjust between 2 to 1500 seconds.
LOW OIL PRESSURE	RED	Unit will not start in AUTO with utility loss.	Check LED's / Screen for alarms.	Check oil level and add oil as needed. If oil level is correct, contact an IASD.
RPM SENSE LOSS	RED	Unit will not start in AUTO with utility loss.	Check LED's / Screen for alarms.	Clear alarm. Using control panel, check battery by navigating to BATTERY MENU option from MAIN MENU. If battery condition displays GOOD, contact an IASD. If control panel displays CHECK BATTERY, replace battery.

Active Alarm	LED	Problem	Action	Solution
OVERCRANK	RED	Unit will not start in AUTO with utility loss.	Check LED's / Screen for alarms.	Verify fuel line shutoff valve is ON. Clear alarm. Start unit in MANUAL. If it does not start, or starts and runs rough, contact an IASD.
LOW VOLTS REMOVE LOAD	RED	Unit will not start in AUTO with utility loss.	Check LED's / Screen for alarms.	Clear alarm and remove household loads from generator. Put into AUTO and restart.
OVERSPEED	RED	Unit will not start in AUTO with utility loss.	Check LED's / Screen for alarms.	Contact an IASD.
UNDERVOLTAGE	RED	Unit will not start in AUTO with utility loss.	Check LED's / Screen for alarms.	Contact an IASD.
UNDERSPEED	RED	Unit will not start in AUTO with utility loss.	Check LED's / Screen for alarms.	Contact an IASD.
STEPPER OVERCURRENT	RED	Unit will not start in AUTO with utility loss.	Check LED's / Screen for alarms.	Contact an IASD.
WIRING ERROR	RED	Unit will not start in AUTO with utility loss.	Check LED's / Screen for alarms.	Contact an IASD.
OVERVOLTAGE	RED	Unit will not start in AUTO with utility loss.	Check LED's / Screen for alarms.	Contact an IASD.
SHUTDOWN SWITCH	FLASHING RED	Unit will not start.	Check emergency shutdown switch(es).	Set emergency shutdown switch(es) to CLOSED (I).
LOW BATTERY	YELLOW	Yellow LED illuminated in any state.	Check screen for additional information.	Clear alarm. Using control panel, check battery by navigating to BATTERY MENU option from MAIN MENU. If battery condition displays GOOD, contact an IASD. If control panel displays CHECK BATTERY, replace battery.
BATTERY PROBLEM	YELLOW	Yellow LED illuminated in any state.	Check screen for additional information.	Contact an IASD.

Active Alarm	LED	Problem	Action	Solution
CHARGER WARNING	YELLOW	Yellow LED illuminated in any state.	Check screen for additional information.	Contact an IASD.
CHARGER MISSING AC	YELLOW	Yellow LED illuminated in any state.	Check screen for additional information.	Contact an IASD.
SERVICE A	YELLOW	Yellow LED illuminated in any state.	Check screen for additional information.	Perform SERVICE A maintenance. Press ENTER to clear.
SERVICE B	YELLOW	Yellow LED illuminated in any state.	Check screen for additional information.	Perform SERVICE B maintenance. Press ENTER to clear.
INSPECT BATTERY	YELLOW	Yellow LED illuminated in any state.	Check screen for additional information.	Inspect battery. Press ENTER to clear.

Section 10: Accessories

Performance enhancing accessories are available for air-cooled generators.

Accessory	Description
<p>Cold Weather Accessories*—</p> <ul style="list-style-type: none"> • Battery Pad Warmer • Oil Warmer • Breather Warmer <p>* each sold separately</p>	<ul style="list-style-type: none"> • Recommended in areas where temperatures fall below 0 °F (-18 °C). <i>(Not necessary for use with AGM-style batteries)</i> • Recommended in areas where temperatures fall below 0 °F (-18 °C). • Recommended in areas where heavy icing occurs.
<p>Scheduled Maintenance Kit</p>	<p>Provides all items necessary to perform complete routine maintenance on a generator, along with oil recommendations (oil not included).</p>
<p>Fascia Base Wrap</p>	<p>The fascia base wrap snaps together around the bottom of the new air-cooled generators. This offers a sleek, contoured appearance as well as offering protection from rodents and insects by covering lifting holes located in the base. Requires use of the mounting pad shipped with the generator.</p>
<p>Touch-Up Paint Kit</p>	<p>If the generator enclosure is scratched or damaged, it is important to touch-up the paint to protect from future corrosion. The touch-up paint kit includes the necessary paint to correctly maintain or touch-up a generator enclosure.</p>
<p>Extended Warranty Coverage</p>	<p>Extend generator warranty coverage by purchasing extended warranty coverage. Covers both parts and labor. Extended coverage can be purchased within 12 months of end-users purchase date.</p> <p>This extended coverage is applicable to registered units, and end-user proof of purchase must be available upon request. Available for Generac® and Guardian® products. Not available for Corepower™, PowerPact®, or EcoGen™ products, or all international purchases.</p>
<p>LTE LP Tank Fuel Level Monitor</p>	<p>The LTE enabled LP tank fuel level monitor provides constant monitoring of the connected LP fuel tank. Monitoring the LP tank's fuel level is an important step in verifying the generator is ready to run during an unexpected power failure. Status alerts are available through a free application to notify users when the LP tank needs a refill.</p>
<p>Mobile Link® Cellular Accessories</p>	<p>Mobile Link family of Cellular Accessories allow users to monitor generator status from anywhere in the world, using a smartphone, tablet, or PC. Easily access information such as the current operating status and maintenance alerts. Users can connect an account with an authorized service dealer for fast, friendly, and proactive service. With Mobile Link, users are taken care of before the next power outage.</p>

Smart Management Module (50 and 100 amps)	Smart Management Modules (SMM's) are used to optimize the performance of a standby generator. They manage large electrical loads upon startup, and shed them to aid in recovery when overloaded. In many cases, using SMM's can reduce the overall size and cost of the system.
Base Plug Kit	Base plugs snap into the lifting holes on the base of air-cooled home standby generators. This offers a sleek, contoured appearance, as well as offers protection from rodents and insects by covering the lifting holes located in the base. Base plug kit contains four base plugs, sufficient for use on a single air-cooled home standby generator.
High Altitude Kit	A high altitude kit may be required when operating over 2,000 ft (610 m) above sea level per U.S. EPA regulations. Operating the engine with the incorrect engine configuration at a given altitude may increase emissions and decrease fuel efficiency and performance.

NOTE: Contact an IASD or visit www.generac.com for additional information on accessories and extended warranties.

This page intentionally left blank.

Section 11: Diagrams

Installation Drawing (A0002360608 rev B—1 of 2)

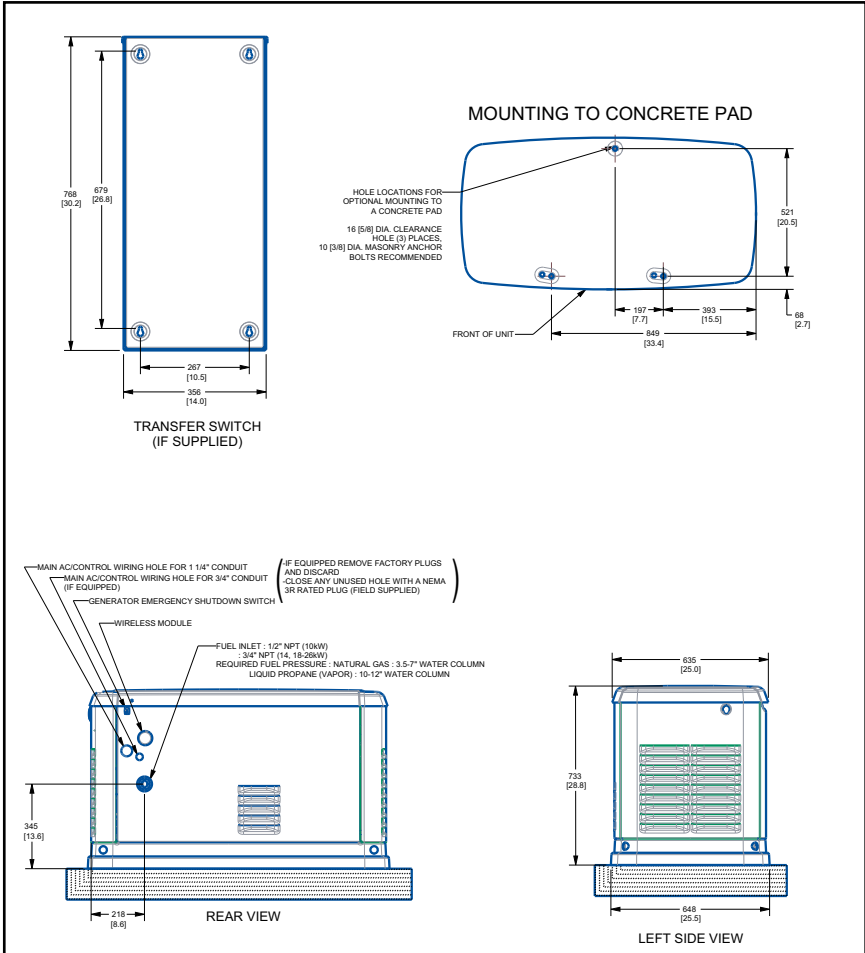

Installation Drawing (A0002360608 rev B—2 of 2)

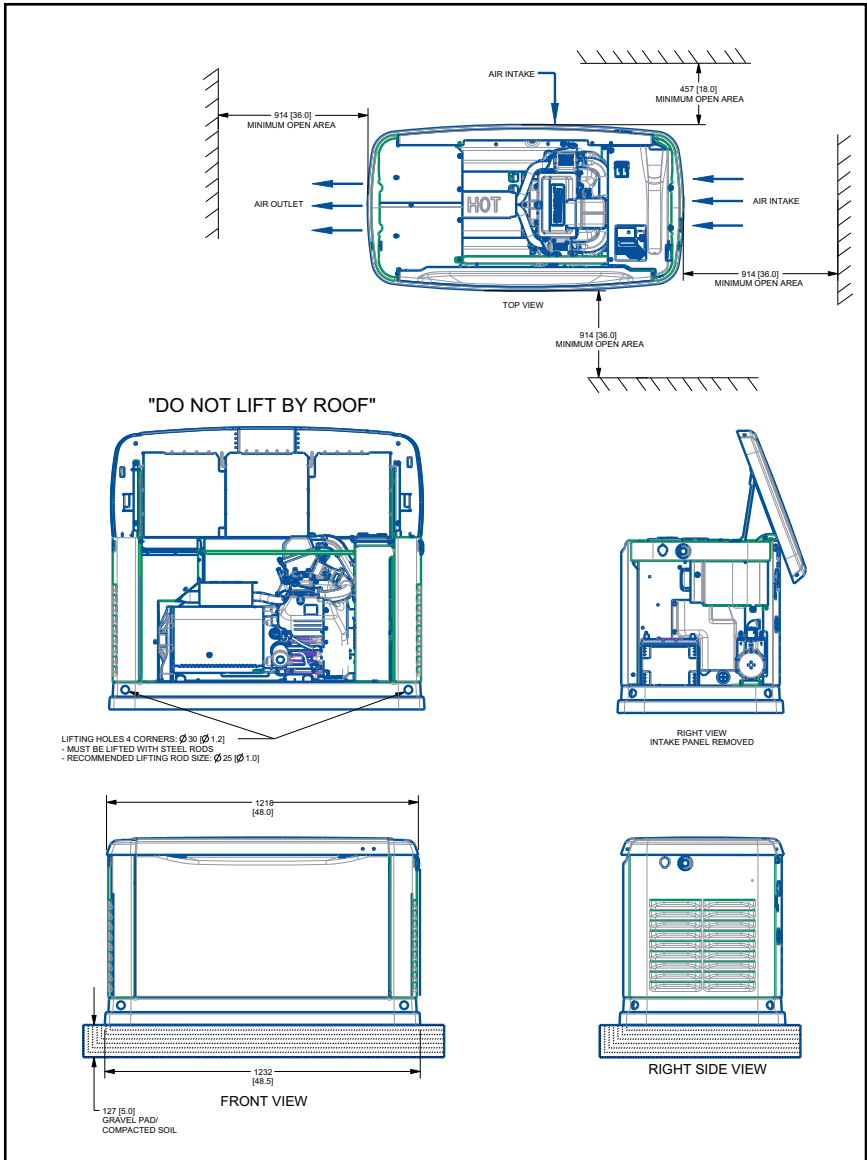

Part No. A0001846478 Rev. D 05/05/2023
©2023 Generac Power Systems, Inc.
All rights reserved
Specifications are subject to change without notice.
No reproduction allowed in any form without prior
written consent from Generac Power Systems, Inc.

GENERAC®



Generac Power Systems, Inc.
S45 W29290 Hwy. 59
Waukesha, WI 53189
1-888-GENERAC (1-888-436-3722)
www.generac.com