

MANUALS

Instructions and warnings **IE**
Installer and Maintenance
technician



UE HYDRO HP5-8-12

Outdoor unit



INDEX

Dear Customer,.....	3	10	Wiring diagrams.....	37
General warnings	4	10.1	UE HYDRO HP5 wiring diagram.....	37
Safety symbols used.....	7	10.2	UE HYDRO HP8 wiring diagram.....	38
Personal protective equipment.....	7	10.3	UE HYDRO HP12 wiring diagram.....	39
1 Product specifications.....	8	11	Setting the microswitches and key functions.....	40
1.1 Product range.....	8	11.1	UE HYDRO HP5 testing operations.....	40
1.2 Accessories.....	8	11.2	UE HYDRO HP8-12 testing operations.....	42
2 Outdoor unit specifications.....	9	12	Maintenance.....	45
3 MAIN COMPONENTS.....	10	12.1	Adding refrigerant.....	45
4 Installing the unit.....	12	12.2	Precautions on adding refrigerant R-32.....	46
4.1 Outdoor unit installation position.....	12	13	CHARGING THE REFRIGERANT.....	47
4.2 Installation guide near the sea.....	12	13.1	Important information: used refrigerant regulation.....	47
4.3 Preparation of fire extinguisher.....	14	14	Completing installation.....	48
4.4 Free ignition sources.....	14	15	Final inspections and test operation.....	49
4.5 Ventilation of the area.....	14	15.1	Inspection prior to test operation.....	49
4.6 Leak detection methods.....	14	15.2	Test operation.....	49
4.7 Labelling.....	14			
4.8 Recovery.....	14			
4.9 Installation place requirements.....	14			
4.10 Moving the outdoor unit with wire ropes.....	15			
4.11 Clearance requirements for the outdoor unit.....	15			
4.12 Installing the outdoor unit.....	17			
4.13 Mount of outdoor unit.....	17			
4.14 Drain.....	18			
4.15 Positioning the unit in a rigid climate.....	20			
5 Electrical connections.....	21			
5.1 General configuration of the system.....	21			
6 Connecting the cable.....	22			
6.1 Power supply cable specifications.....	22			
6.2 Specifications of connecting cables.....	22			
6.3 Specifications of single-phase terminal block.....	22			
6.4 Power cable connection diagram.....	23			
6.5 Connection of power terminal.....	25			
6.6 Installation of earthing wire.....	26			
6.7 How to connect power supply extension cables.....	26			
7 Proper earthing check.....	29			
8 Pipe implementation.....	30			
8.1 Air WASH and PURGE.....	30			
8.2 Head losses of the outdoor unit based on glycol concentration.....	33			
8.3 Water loading.....	35			
8.4 Pipe insulation.....	35			
9 Cooling cycle diagram.....	36			

Dear Customer,

Congratulations for having chosen a top-quality Immergas product, able to assure well-being and safety for a long period of time. As an Immergas Customer, you can also count on a qualified after-sales service, prepared and updated to guarantee constant efficiency of your heat pump. Read the following pages carefully: you will be able to draw useful tips on the proper use of the device, compliance with which will confirm your satisfaction with the Immergas product.

For assistance and routine maintenance, contact Authorised Immergas Service Centres: they have original spare parts and are specifically trained directly by the manufacturer.

IMPORTANT

Thermal systems must undergo periodic maintenance and scheduled checks of the energy efficiency in compliance with national, regional or local provisions in force. In order to fulfil the obligations set forth by the Law, we urge you to contact the Authorised Immergas Service Centres, which will illustrate to you the advantages of the Formula Comfort operation.

The company **IMMERGAS S.p.A.**, with registered office in via Cisa Ligure 95 42041 Brescello (RE), declares that the design, manufacturing and after-sales assistance processes comply with the requirements of standard **UNI EN ISO 9001:2015**.

For further details on the product CE marking, request a copy of the Declaration of Conformity from the manufacturer, specifying the appliance model and the language of the country.

The manufacturer declines all liability due to printing or transcription errors, reserving the right to make any modifications to its technical and commercial documents without forewarning.



Correct disposal of the product

(Waste electrical and electronic equipment)(Applicable in Countries with separate waste collection systems)

When this symbol is applied on the product, on the accessories or on its documentation, it means that the product and relative electronic accessories must not be disposed of with other waste at the end of its life cycle. To avoid damaging the environment or health due to incorrect waste disposal, the user is recommended to separate the product and the above-mentioned accessories from other types of waste and to recycle them responsibly by sending them to authorised facilities in compliance with local standards.

Household users are encouraged to contact the dealer where they purchased the product or the competent authorities to receive all of the information regarding the separate waste collection of these products so that they may be disposed of properly without harming the environment.

Corporate users should contact their supplier and verify the terms and conditions of the purchase contract. This product and relative electronic accessories must not be disposed of together with other commercial waste

GENERAL WARNINGS

- Carefully follow the precautions listed below as they are crucial to guarantee the safety of the product.

ATTENTION:

- **Always disconnect power to the condensing unit before performing maintenance on it or accessing the components inside the unit.**
- **Make sure that installation and inspection operations are carried out by qualified personnel.**
- **They must comply with the precautions and other important warnings to avoid seriously damaging the system and injuring the users.**



- Carefully read the content of this manual before installing the condensing unit and keep it in a safe place so that it can be referred to after installation.
- For greater safety, the installers should always read the following warnings with the utmost attention.
- Store the use and maintenance manual in a safe place and remember to hand it over to the new owner should the condensing unit be sold or transferred.
- This manual explains how to install the condensing unit. Using other types of units with different control systems can damage the units and invalidate the warranty. The manufacturer will not be held liable for damage resulting from improper use of the unit.
- The manufacturer cannot be held liable for damage resulting from unauthorised changes or improper connection of the electric and hydraulic lines. Failure to comply with these instructions or the requirements set forth in the “Operating limits” table, including those in the manual, immediately invalidates the warranty.
- Failure to comply with these instructions and the production specifications immediately invalidates the warranty.
- Do not use the units if you notice any damage on them or if you perceive something strange, such as a loud noise or burnt smell.
- To prevent electrocution, fire or injury, always switch off the unit, disable the protective switch and, if smoke escapes or if the unit is extremely noisy, contact the authorised technical service centre.
- Remember to inspect the unit at regular intervals, including the electrical connections, the refrigerant pipes and the protections.
- These operations must only be done by qualified personnel.
- The unit contains moving and electric parts which must always be kept out of the reach of children.
- Do not have unauthorised personnel attempt to repair, move, modify or reinstall the unit. These operations could cause damage to the product, electric shocks and fire.
- Do not place liquid containers or other objects on the unit.
- All the materials used to manufacture and package the condensing unit are recyclable.
- The packaging material and the dead batteries of the remote control (optional) must be disposed of in compliance with local standards.
- The refrigerant in the condensing unit must be disposed of as special waste. At the end of its service life, the condensing unit must be disposed of in an authorised centre or returned to the shop so that it can be disposed of correctly and safely.
- Wear protective gloves to unpack, move, install and repair the unit to prevent your hands from being injured by the edges of the parts.
- Do not touch the internal parts (water pipes, refrigerant pipes, heat exchanger, etc.) while the unit is operating. If you need to adjust and touch the unit, allow sufficient time for it to cool down and be sure to wear protective gloves.
- In case of refrigerant leaks, try not to come into contact with the refrigerant as this could cause serious injury.
- If the condensing unit is installed in a small room, consider adequate ventilation to avoid a leak level beyond the maximum allowed limit. In that case, there is the risk of death by suffocation.

- Make sure to dispose of the packaging materials safely. The packaging items, such as nails and other metals or wooden pallets can cause injuries to children.
- Inspect the shipped product and make sure it was not damaged during transport. If you notice any damage, **DO NOT INSTALL THE PRODUCT** and immediately report any damage to the carrier or dealer (if the installer or authorised technician withdrew the material from the dealer).
- Our units must be installed according to the clearance spaces described in the installation manual so that both sides are accessible and to allow for repairs and maintenance to be performed. If the units are installed without complying with the procedures described in the manual, additional costs could be required since special wiring, ladders, scaffolds or any other elevation system for repairs are **NOT** considered covered by the warranty and are therefore charged to the end customer.
- Always make sure that the power supply complies with local safety standards.
- Check that the supply voltage and frequency comply with the specifications and that there is sufficient input power to guarantee operation of any other household appliance connected to the same power lines. Always make sure that the on-off switches and circuit breakers are selected appropriately.
- Always check that the electrical connections (cable inlet, wire cross-section, protections, etc.) comply with the electrical specifications and with the instructions in the wiring diagram. Always check that all of the connections comply with the regulations applicable to installation of the heat pumps. The devices not connected to the power supply must be completely disconnected according to the conditions envisaged by the overvoltage categories
- Do not connect the earth wire to the gas piping, to the water piping, to the lightning rod, to the overvoltage absorber or to the telephone cable. An electric shock or a fire could occur if earthing is not complete.
- Make sure to install both the earth leakage detector and the circuit switch of the capacity specified in compliance with local and national standards in force. If they are not installed properly, they can cause electric shocks and fires.
- Make sure that condensate exits properly from the unit at low room temperature. Do not allow frost or ice to form on the drain pipe or on the heater. If the drain is not done properly for release of condensate, the units could be damaged by ice blocks and the system could be stopped, covered with ice.
- Install the power cable and the communication cable between the indoor and outdoor unit at least 1 m from the household appliance.
- Protect the appliance against mice or small animals. If an animal creates a contact with electric parts, it could cause malfunctioning, smoke or fires. Inform the customer to keep the area around the unit clean.
- Do not disassemble or modify the heater on your own initiative.
- This appliance is not intended to be used by persons (including children) with reduced physical, sensory or mental capabilities or lacking experience and the necessary knowledge, unless they are supervised or trained on use of the appliance by someone in charge of their safety. Children must be supervised to make sure they do not play with the appliance.
- For use in Europe: This appliance may be used by children at least 8 years old or by persons with reduced physical, sensory or mental capabilities or lacking experience and basic notions, as long as they are supervised or properly trained on safe use of the appliance and are aware of the risks posed by it. Do not allow children to play with the appliance. The appliance must not be cleaned and serviced by children without the supervision of an adult.
- Make sure not to modify the power cable, to make extensions or connections with several wires.
- This could cause electrocutions or fire due to connections or insulation made improperly or exceeding the current limit. If extensions need to be made due to damage along the power line, see chapter “How to connect extension cables” in the installation manual.
- Do not use any means to speed up the defrosting operation or to clean other than those recommended by Immergas.
- Do not puncture or burn.
- Be aware that refrigerants are odourless.

SAFETY SYMBOLS USED.



GENERIC HAZARD

Strictly follow all of the indications next to the pictogram. Failure to follow the indications can generate hazard situations resulting in possible harm to the health of the operator and user in general.



ELECTRICAL HAZARD

Strictly follow all of the indications next to the pictogram. The symbol indicates the appliance's electrical components or, in this manual, identifies actions that can cause an electrical hazard.



LOW FLAMMABILITY MATERIAL

The symbol indicates that the appliance contains low flammability material.



WARNING FOR INSTALLER

Read the instruction booklet carefully before installing the product.



NOTE FOR INSTALLER

Indicates useful tips or additional information for the installer.



WARNING FOR USER

Read the instruction booklet carefully before using the product.

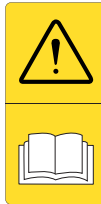

READ AND UNDERSTAND THE INSTRUCTIONS

Read and understand the appliance's instructions before performing any operation, carefully following the indications provided.



INFORMATION

Indicates useful tips or additional information in general.



The user must not dispose of the appliance at the end of its service life as municipal waste, but send it to appropriate collection centres.

PERSONAL PROTECTIVE EQUIPMENT.



SAFETY GLOVES





SAFETY GOGGLES



SAFETY FOOTWEAR

1 PRODUCT SPECIFICATIONS.

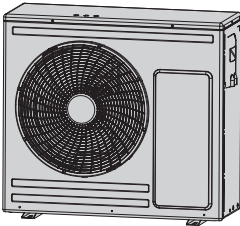
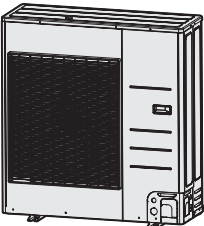

1.1 PRODUCT RANGE.

Range				
Heat pumps	Frame			
	Model name	UE HYDRO HP5	UE HYDRO HP8	UE HYDRO HP12

1.2 ACCESSORIES.

Keep the supplied accessories at hand until installation is finished.
Give the installation manual to the customer at the end of installation.

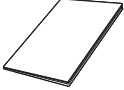
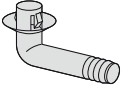
The amounts are indicated in brackets.

Installation manual (1)	Drain plug (1)	Rubber feet (4)	Drain plug (3)
			

2 OUTDOOR UNIT SPECIFICATIONS.

Type	Unit	UE HYDRO HP5	UE HYDRO HP8	UE HYDRO HP12
Power supply	-	1P, 220~240 VAC, 50 Hz		
Compressor	-	Twin Rotary		
Oil compressor	-	POE		
Fan - Unit number		1		2
Fan - Air flow	CMM	51	66	99
Refrigerant load	Kg	1.0	1.15	2.2
Type of refrigerant		R32		
Refrigerant control method		EEV		
Water side connection - IN	ø	1"		
Water side connection - OUT	ø	1"		
Sound pressure level ((central heating / cooling)	dB(A)	45 / 45	48 / 48	50 / 50
Sound power level ((central heating / cooling)	dB(A)	61 / 62	63 / 64	64 / 65
Operating field (central heating / cooling)	°C	-25~35/10~46		
Weight (net / gross)	kg	58.5 / 62.5	76.0 / 84.5	110.0 / 119.0
Dimensions (L x H x D, net)	mm	880 x 798 x 310	940 x 998 x 330	940 x 1420 x 330

3 MAIN COMPONENTS

UE HYDRO HP5 overall dimensions in mm

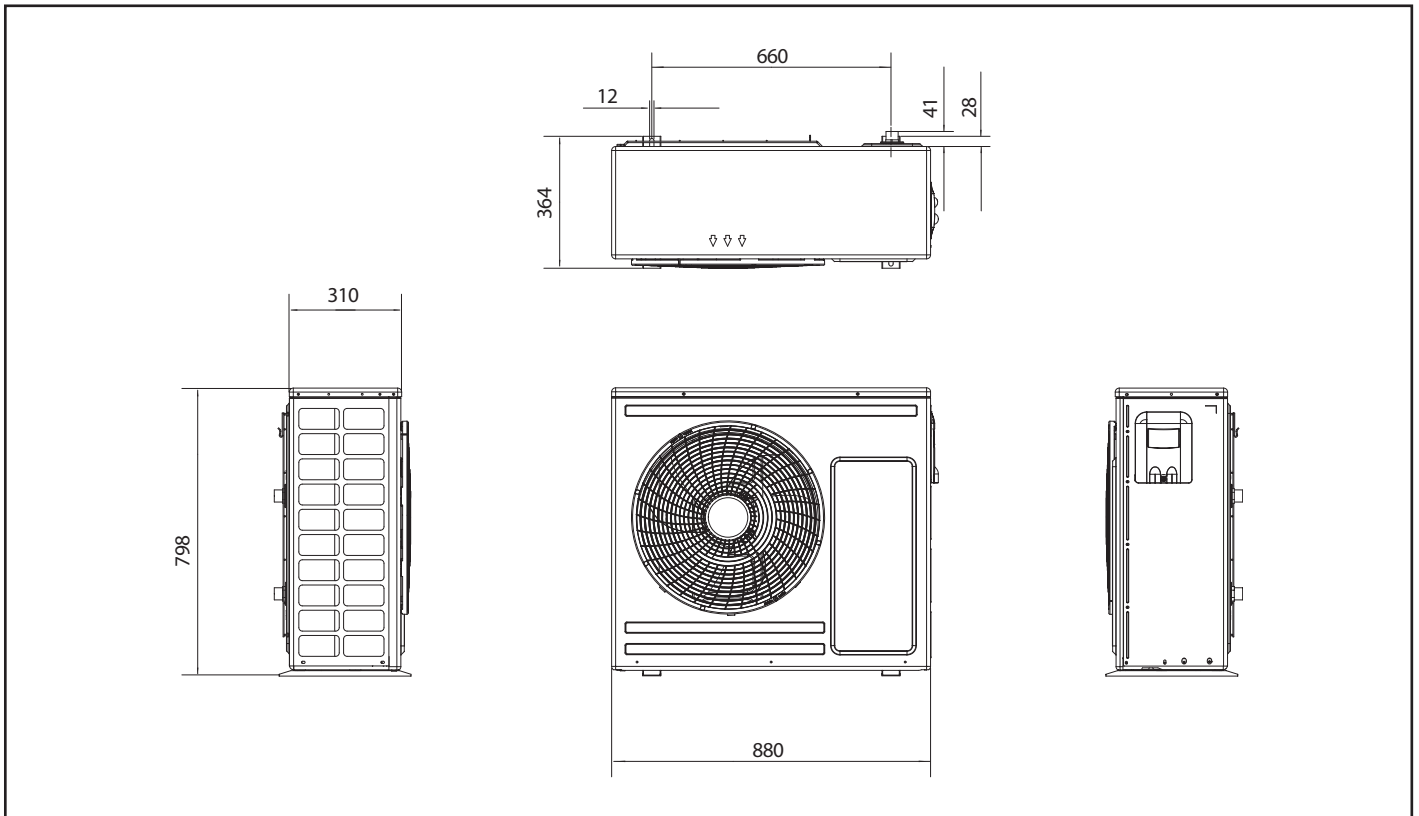

UE HYDRO HP8 overall dimensions in mm

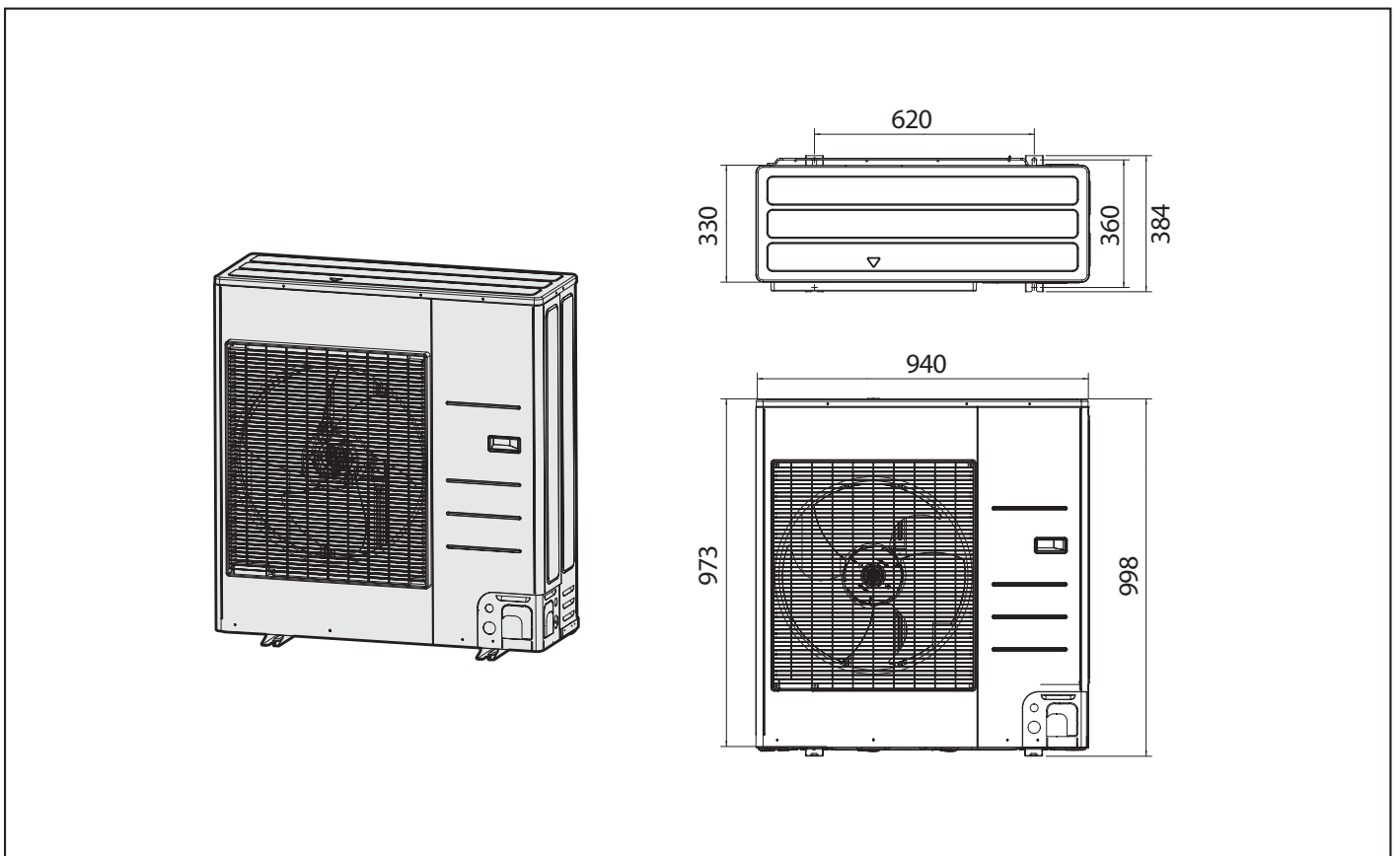

UE HYDRO HP12 overall dimensions in mm

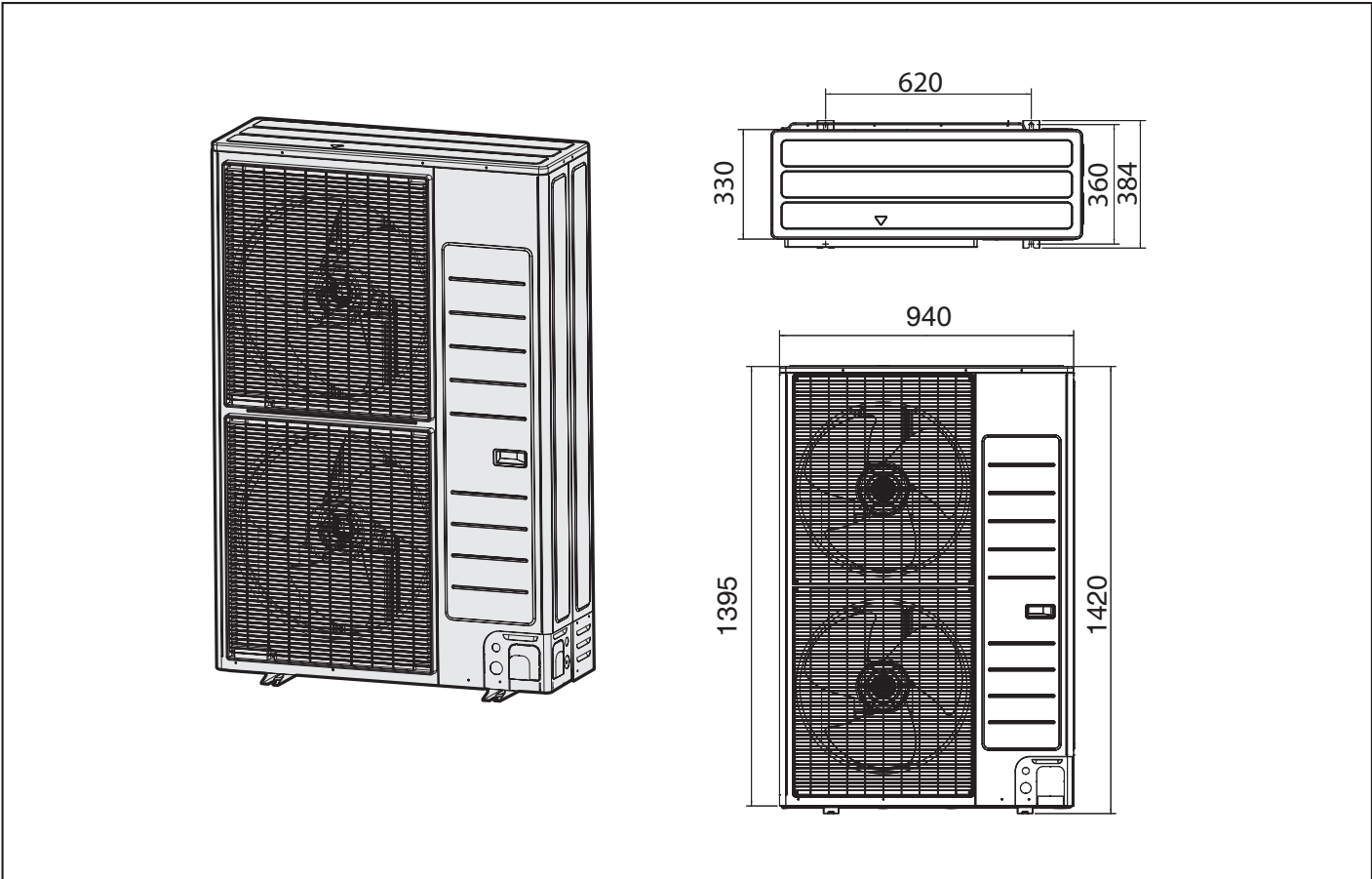

4 INSTALLING THE UNIT.

4.1 OUTDOOR UNIT INSTALLATION POSITION.

Determine the installation site considering the following conditions and get the user's approval.

- The outdoor unit must not be positioned on its side or upside down, as the lubricating oil of the compressor could enter the cooling circuit and seriously damage the unit.
- Choose a dry and sunny position, though not exposed to direct sunlight or to strong wind.
- Do not block passages or exit routes.
- Choose a location where the noise of the heat pump during operation and the discharged air do not disturb neighbours.
- Choose a location where the pipes and cables can be easily connected to other elements of the hydraulic system.
- Install the outdoor unit on a flat and stable surface capable of bearing its weight and which does not generate any useless noise and vibrations.
- Position the outdoor unit so that the air flow is directed outdoors.
- Position the outdoor unit where there are no trees or animals which could impair its operation.
- Leave sufficient space around the outdoor unit, especially for radios, computers, stereo systems, etc.

4.2 INSTALLATION GUIDE NEAR THE SEA.

Make sure to follow these guidelines for installation along the seacoast.

1. Do not install the appliance where it is directly exposed to sea water or breeze.

- Install the product behind a structure (like a building) which can block the sea breeze.
- Even when it is inevitable to install the appliance along the seacoast, make sure it is not exposed directly to the sea breeze by installing a protective wall.

2. Bear in mind that salty particles that come into contact with the outdoor panels must be removed by often washing them appropriately.

3. Since residual water at the bottom of the outdoor unit significantly promotes corrosion, make sure the slope does not affect drainage.

- Keep the floor level so that rain does not make any puddles.
- Be careful not to obstruct the drain hole with foreign substances

4. Make sure to install the appliance where water can be drained conveniently. In particular, make sure that the base drains well.

5. If the appliance is drained during installation or maintenance, make sure to restore it.

6. Regularly check the condition of the product.

- Check the installation site every 3 months and perform an anti-corrosion treatment with grease and water-repellent wax according to the conditions of the appliance.

- Take appropriate measures when the product needs to be stopped for a long period of time, for example by covering it.

7. The product requires a special anti-corrosion treatment if installed within 500 m from the sea.

For further information, contact Immergas Authorised Technical Assistance Centre.

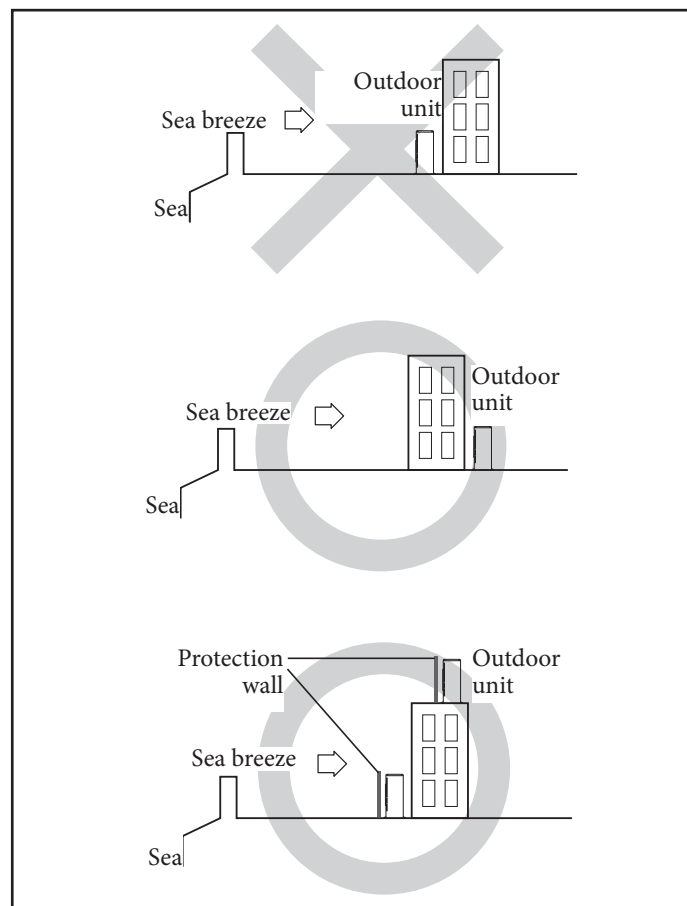

N.B.: the protective wall must be built with solid and sturdy material capable of blocking the sea breeze and its height and width must be 1.5 times larger than those of the outdoor unit. (To guarantee ventilation, the protective wall must be at least 700 mm from the outdoor unit).

ATTENTION:

Depending on the power supply conditions, power instability or voltage can cause malfunctioning of the parts or of the control system. (On ships or in places powered by an electric generator, etc.).



Do not install the heat pump in the following locations.

- Places where there is mineral oil or arsenic acid. Parts could be damaged by burnt resin. The capacity of the heat exchanger could be reduced or the heat pump could fail.
- Places where exhaust fans eject corrosive gases such as sulphuric acid. Copper pipes or connection pipes would be corroded with subsequent refrigerant leaks.
- Places with the risk of leaks of combustible gases, carbon fibres or flammable dust. Places where thinners or petrol are handled.

ATTENTION:

This device must be installed according to current electrical standards. If the outdoor unit has a net weight over 60 kg, we suggest not to install it on the wall but on the floor.



- If the outdoor unit is installed at a certain height, make sure that its base is firmly fastened in place.
- Make sure that the condensate water collected by the drain hose is disposed of properly and safely.
- When the outdoor unit is installed on the road, it must be installed at a height of more than 2 m or in such a way that the heat emitted by the outdoor unit does not come into direct contact with passers-by. (Refer to standards in force relating to structures in the construction field).
- During installation or transfer of the product, do not mix the refrigerant with other gases, including air or unspecified refrigerant. Otherwise it could cause an increase in pressure, causing ruptures or injury.
- Do not cut or burn the container or the refrigerant pipes.
- Use clean parts, such as pressure gauge, vacuum pump and flexible hose to charge the refrigerant.
- Installation must be carried out by personnel qualified to handle the refrigerant. Also consult the regulations and laws.
- Do not allow foreign substances (lubricating oil, refrigerant other than R-32, water, etc.) to penetrate into the pipes.
- When mechanical ventilation is required, the vents must be kept clear of obstacles.
- Follow the local laws and standards to dispose of the product.
- Do not work in a closed area.

- The work area must be blocked.
- The following checks must be carried out for installation:
 - The fan devices and the outlets work properly and are not obstructed.
 - The signs and signals on the equipment must be visible and legible.
- Air out the room if any refrigerant leaks. Toxic gas could be generated if the refrigerant leak is exposed to fire.
- Make sure there are no flammable substances in the work area.
- Use a vacuum pump to bleed the air in the refrigerant.
- The refrigerant is odourless.
- The units are not explosion-proof. Therefore they must be installed in areas without risk of explosion.
- This product contains fluorinated gases which contribute to the global greenhouse effect. For this reason do not release the gases into the environment.
- To perform maintenance involving handling the refrigerant (R-32), use specific tools and pipe materials.
- Maintenance and installation must be carried out according to the manufacturer's instructions. If other qualified persons participate in maintenance, it must be carried out under the supervision of personnel competent in handling slightly flammable refrigerants.
- For maintenance of units containing slightly flammable refrigerants, safety checks must be performed to minimise the risk of fire.
- Maintenance must be carried out according to the control procedure to minimise the risk of refrigerant or flammable gas leakage.
- Do not install in places where there is the risk of combustible gas escaping.
- Do not install near sources of heat.
- Pay attention not to generate sparks as follows:
 - Do not remove the fuses while the unit is on.
 - Do not unplug the unit while it is on.
- It is recommended to place the socket above. Lay the cables in such a way that they do not get tangled.
- After installation, check for leaks. Toxic gases could be generated in case of ignition with sources such as thermal fan, stove and cylinders. Use only specific refrigerant gas recovery cylinders.
- Never directly touch any accidentally leaking refrigerant - this could cause severe frostbite.

4.3 PREPARATION OF FIRE EXTINGUISHER.

- If hot work needs to be carried out, prepare adequate fire-fighting equipment.
- Set up a dry powder or CO₂ extinguisher in the vicinity of the charging area.

4.4 FREE IGNITION SOURCES.

- Make sure to store the units in a place without ignition sources in continuous operation (for example naked flames, gas-fired appliances or electric stoves).
- Maintenance technicians must not use ignition sources that generate the risk of fire or explosion.
- Potential ignition sources must be kept away from the work area where the flammable refrigerant could be released in the surrounding environment.
- The work area must be controlled to make sure that there are no flammable substance hazards or risks of ignition. A “No smoking” sign must be affixed.
- Under no circumstances must potential ignition sources be used during leak detection.
- Make sure that the gaskets and sealing materials are not worn.
- Safe components are those which personnel can work with in a flammable environment. Other parts can cause ignition due to leaks.
- Only replace the components with the parts specified by the supplier. Other parts can cause ignition of refrigerant in the environment due to leaks.

4.5 VENTILATION OF THE AREA.

- Make sure that the work area is well ventilated before performing hot work.
- Ventilation must also be carried out during work.
- Ventilation must safely disperse all of the released gases and preferably expel them into the atmosphere.

4.6 LEAK DETECTION METHODS.

- The leak detector must be calibrated in an environment without refrigerant.
- Make sure that the detector is not a potential source of ignition.
- The leak detector must be set at LFL (lower flammability limit).
- Detergents containing chlorine must not be used for cleaning as the chlorine can react with the refrigerant and corrode the piping.
- Remove naked flames if you suspect any leaks.
- If the leak is detected during braze welding, all of the refrigerant must be recovered from the product or isolated (for example using shut-off valves). It must not be released directly into the environment. Oxygen-free nitrogen (OFN) must be used to purge the system before and during the braze welding process.
- The work area must be controlled with an appropriate refrigerant liquid detector before and during work.
- Make sure that the leak detector is suitable to be used with flammable refrigerants.

4.7 LABELLING.

- The parts must be labelled to guarantee that they have been dismantled and refrigerant emptied.
- The labels must bear the date.
- Make sure that specific labels are applied on the system to inform that it contains flammable refrigerant.

4.8 RECOVERY.

- When the refrigerant is removed from the system to perform maintenance or decommissioning, remove all of it (refer to legislation in force in the country of destination).
- When the refrigerant is transferred to cylinders, make sure that refrigerant recovery cylinders, specific for slightly flammable gases, are used.
- All of the cylinders used for the recovered refrigerant must be labelled.
- The cylinders must be equipped with pressure limiting valves and shut-off valves in the correct order.
- The recovery system must work normally according to the specified instructions and must be suitable for refrigerant recovery.
- Furthermore, the calibration scales must work normally.
- The couplings of the flexible hoses must not leak.
- Before starting recovery, check the recovery system for proper conditions and sealing. Contact the manufacturer if in doubt.
- The parts must be labelled to guarantee that they have been decommissioned and refrigerant emptied. Contact the manufacturer if in doubt.
- The recovered refrigerant must be sent back to the supplier in suitable recovery cylinders with a Waste Transfer Note attached.
- Do not mix refrigerants in recovery units or cylinders.
- If compressors or compressor oils must be removed, make sure that they have been evacuated to an acceptable level to guarantee that no flammable refrigerant remains in the lubricant.
- The evacuation procedure must be performed before sending the compressor to the supplier.
- Only electrical heating of the compressor body is allowed to speed up the process.
- The oil must be safely drained from the system.
- Never install a motorised appliance to avoid ignition.
- Empty recovery cylinders must be vacuum and cooled before recovery.

4.9 INSTALLATION PLACE REQUIREMENTS.

- The outdoor unit must be installed in an open space always ventilated.
- Local regulations on gas must be complied with.
- For indoor installation, a minimum air-conditioned area is mandatory according to IEC 60335-2-40: 2018 (see the reference table in the installation manuals of the indoor or outdoor unit).
- To handle, bleed or dispose of the refrigerant or to interrupt the refrigerant circuit, personnel must be in possession of a certificate supplied by an accredited authority in the sector.

4.10 MOVING THE OUTDOOR UNIT WITH WIRE ROPES.

Fasten the outdoor unit with two 8 m or larger wire ropes as shown. Insert a piece of cloth between the outdoor unit and the cables to protect it from damage or scratches, then move the unit.

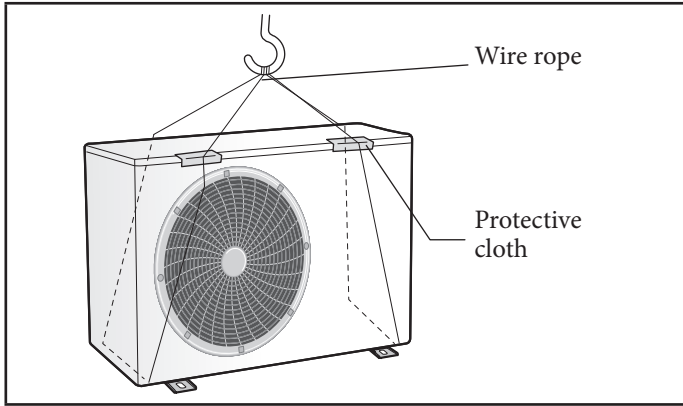

* The appearance of the unit may differ from the image depending on the model.

4.11 CLEARANCE REQUIREMENTS FOR THE OUTDOOR UNIT.

Installation of a single outdoor unit

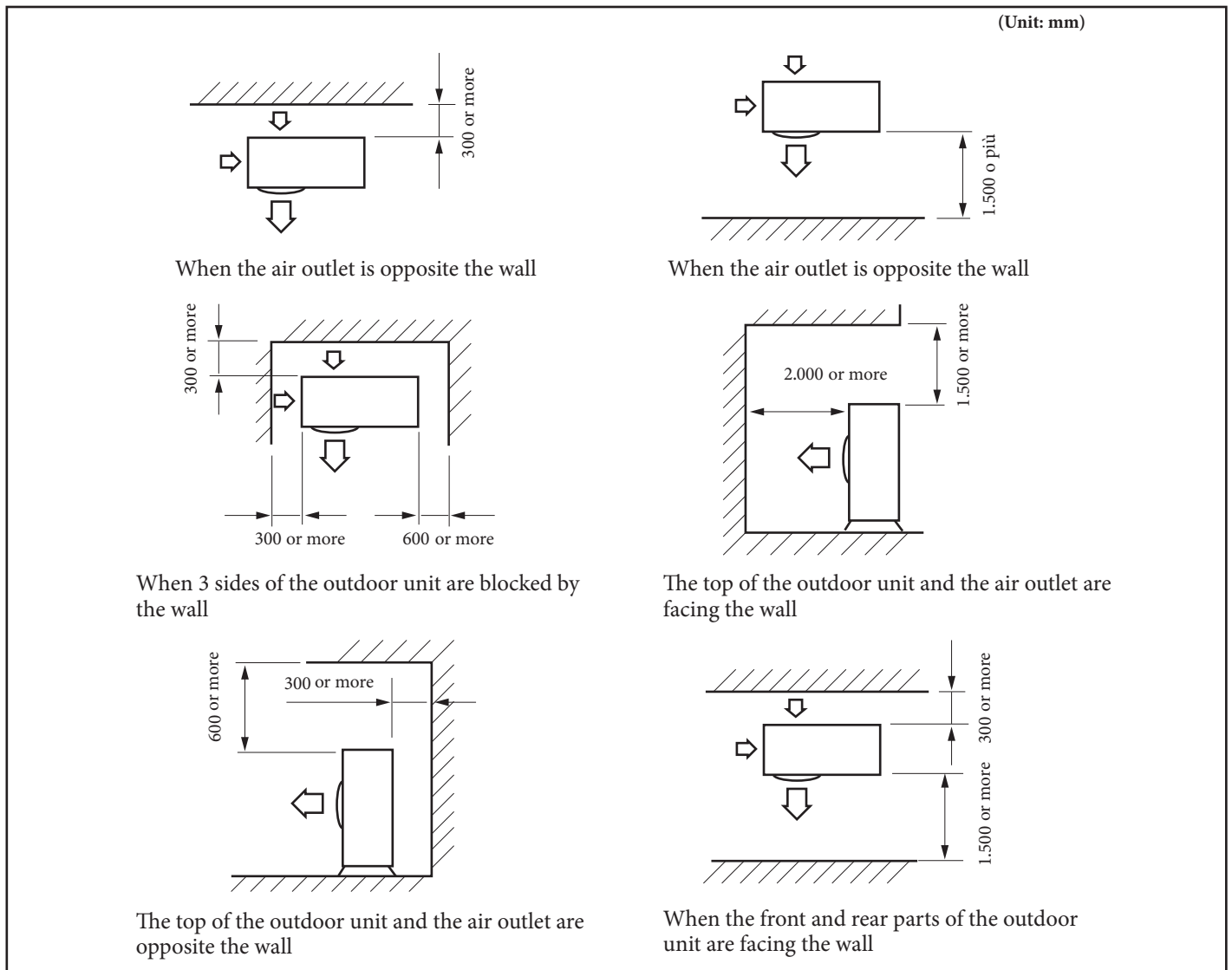

Installation of several outdoor units

(Unit: mm)

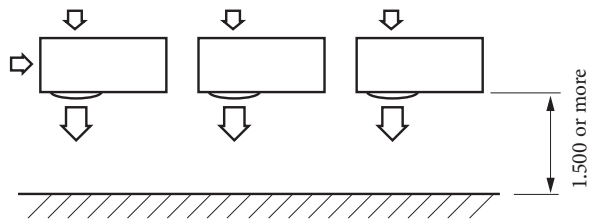

When the air outlet is facing the wall

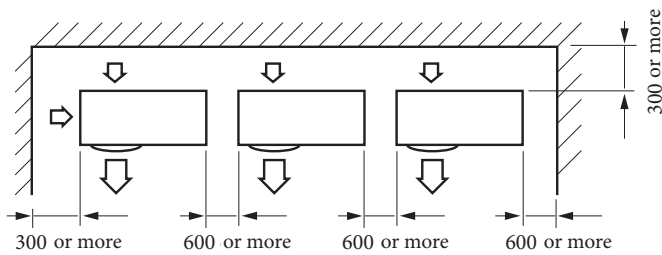

When 3 sides of the outdoor unit are blocked by the wall

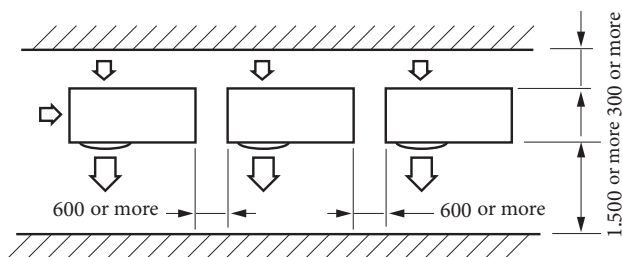

When the front and rear parts of the outdoor unit are facing the wall

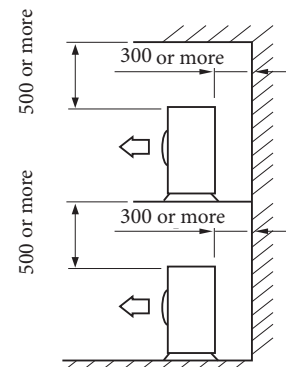

The top of the outdoor unit and the air outlet are opposite the wall

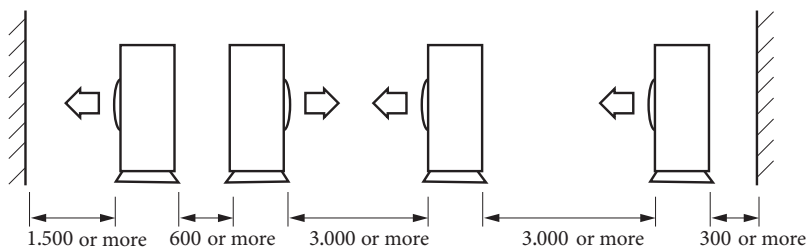

When the front and rear parts of the outdoor unit are facing the wall

ATTENTION:

The units must be installed complying  with the specified distances so that it can be accessed from both sides and to guarantee the proper operation, maintenance and repair of the appliance. The parts of the unit must be able to be completely reached and removed in safe conditions (or persons or objects).

4.12 INSTALLING THE OUTDOOR UNIT.

The outdoor unit must be installed on a rigid and stable base to prevent any increase in noise or vibration. In particular if the outdoor unit needs to be installed in a position exposed to strong winds or at a certain height, it must be secured to an appropriate mount (wall or ground).

- Secure the outdoor unit with anchor bolts.

The anchor bolt must be at least 20 mm from the base surface.



UE HYDRO HP5

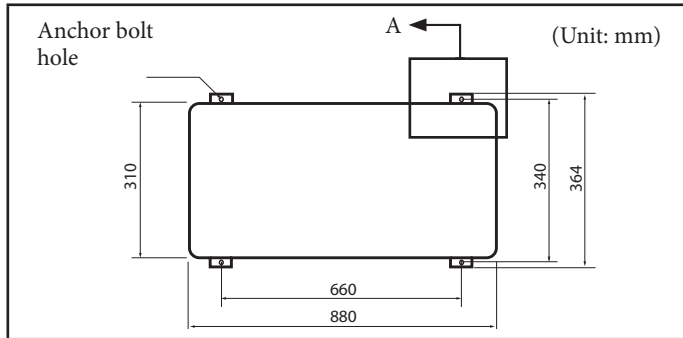

UE HYDRO HP8-12

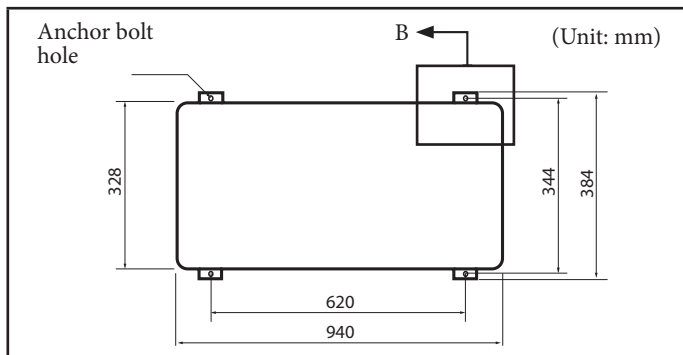

ATTENTION:



- When tightening the anchor bolt, tighten the rubber washer so that the connection part of the bolt to the outdoor unit is not subject to corrosion.
- Make a discharge hole around the base for drainage of the outdoor unit.
- If the outdoor unit is installed on the roof, you must check the resistance of the ceiling and waterproof the unit.

4.13 MOUNT OF OUTDOOR UNIT.

Outdoor unit installed on the wall with mount.

- Make sure that the wall is capable of bearing the weight of the mount and of the outdoor unit.
- Install the mount as near as possible to the column.
- Install an adequate gasket to reduce noise and residual vibration transferred from the outdoor unit to the wall.

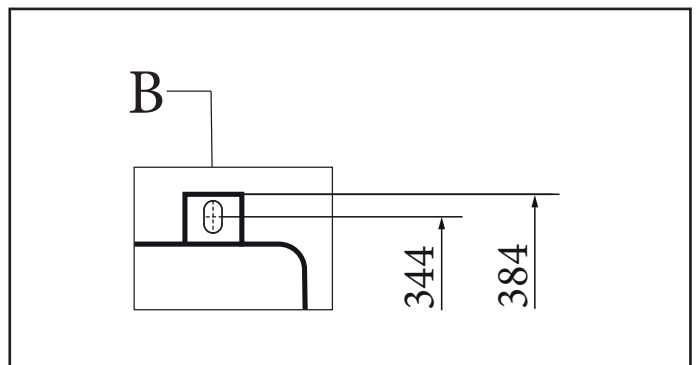
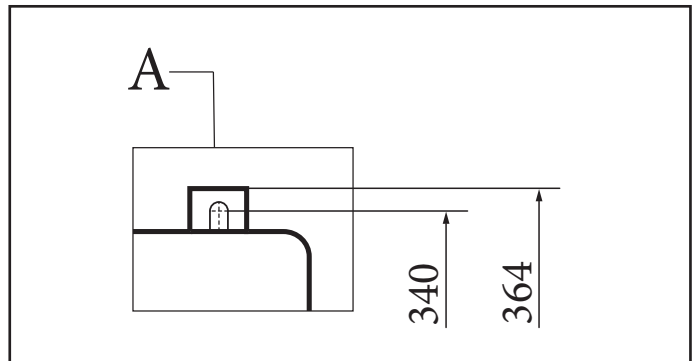
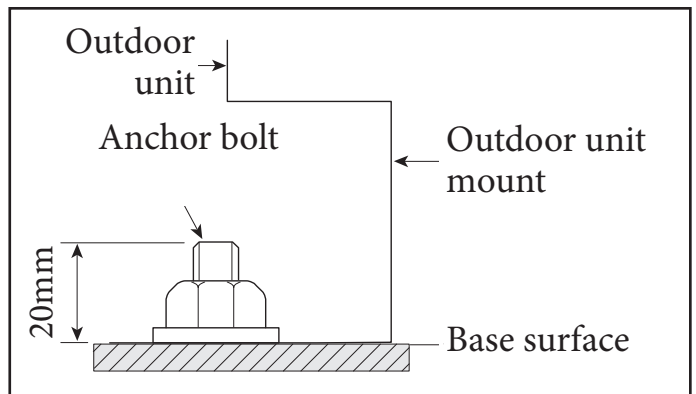
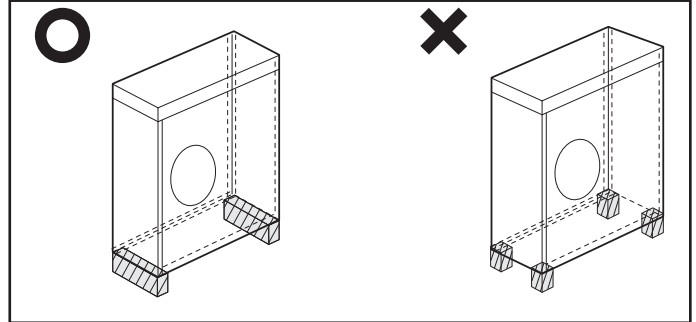

4.14 DRAIN.

General Area

When the heat pump is running in central heating mode, ice could start to build up on the external finned coil. To prevent the amount of from increasing, the system enters defrost mode, thereby transforming the ice on the surface into water. The water dripping from the external finned coil is eliminated by making drainage holes to prevent the ice from forming at low temperatures.

Additional drainages are required if there is not sufficient space to drain the unit. Follow the instructions below.

- Leave more than 100 mm between the bottom of the outdoor unit and the ground to install the drain pipe.
- Insert the drain sleeve in the hole on the bottom side of the outdoor unit.
- Connect the drain pipe to the drain sleeve.
- Make sure that no dust or small branches clog the drain pipe.

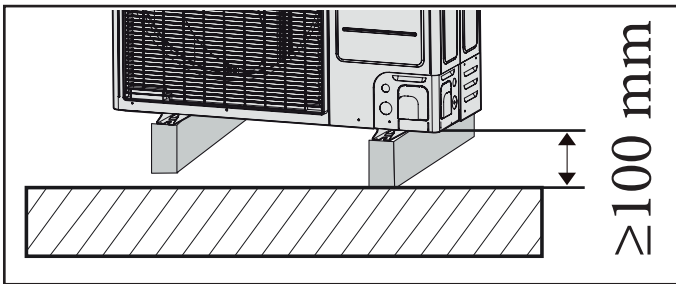

ATTENTION:
Insufficient drainage could downgrade performance and damage the system.



UE HYDRO HP8-12

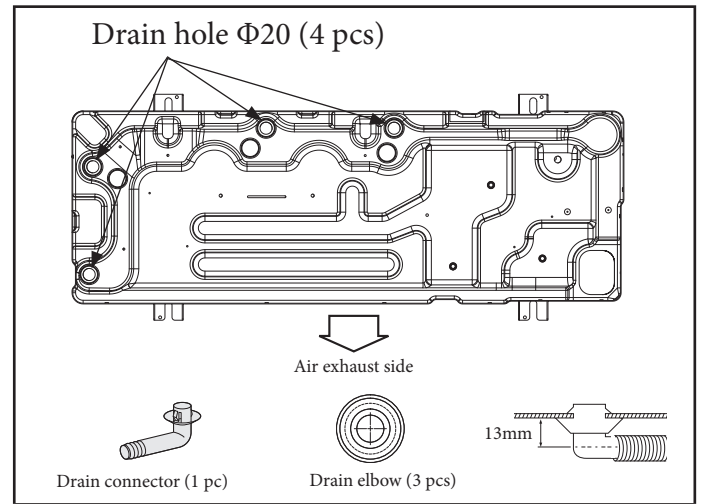

1. Prepare a water discharge channel around the base, to drain the water around the unit.
2. If the water does not drain easily, lift the unit onto a cement block base, etc. (the height of the foundation should be maximum 150 mm).
3. When installing the unit in a place subject to frequent snow-falls, pay special attention to elevate the base as high as possible.
4. If the unit is installed on a frame, install a waterproof plate (not available from Immergas) within 150 mm from the bottom of the unit in order to prevent water from penetrating from below.
5. If wall-mounted (see figure), it would be advisable to place a collection tray (not available from Immergas) below it, at about 150 mm from the bottom of the unit, for the condensate, which could drip from the appliance, to be collected and drained in a controlled manner.

UE HYDRO HP5

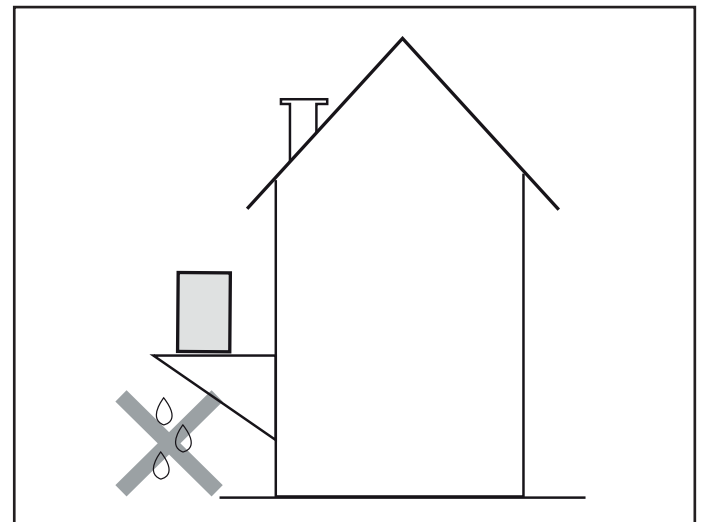
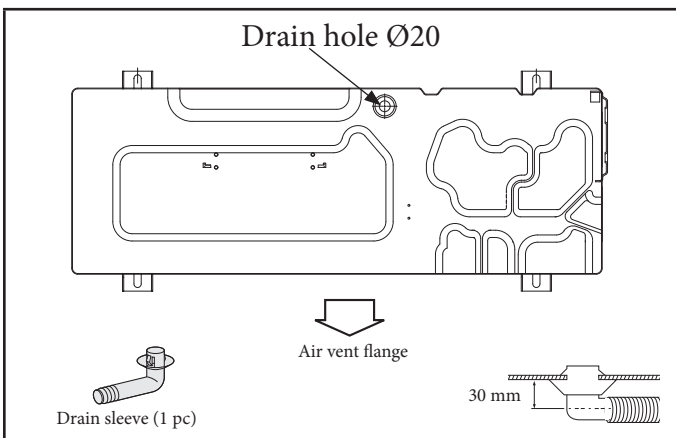

Area with intense snowfalls (natural drain)

Ice can build up when using the heat pump in central heating mode. During de-icing, the condensate water must be drained safely. For the appliance to work properly, follow the instructions below.

- Leave more than 80 mm between the bottom of the outdoor unit and the ground for the installation.

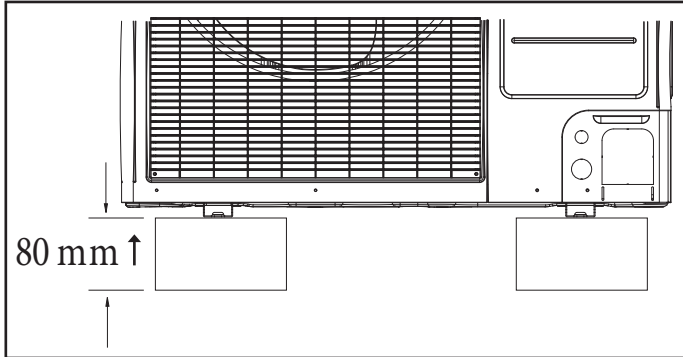

- If the appliance is installed in a region with heavy snowfalls, leave sufficient space between it and the ground.
- When you install the product, make sure that the mount is not positioned below the drain hole.
- Make sure that the drain water flows out correctly and safely.

ATTENTION:



- **In zones subject to heavy snowfalls, the snow build-up could block in the air vents. To avoid this occurrence, install a frame higher than the estimated level of the snow. Furthermore, install a snow-proof cover to prevent the snow from building up on the outdoor unit.**
- **In zones subject to snowfalls, do not install the discharge outlet and the drain plug in the outdoor unit. They could make the ground freeze. Therefore, take appropriate measures to prevent it.**

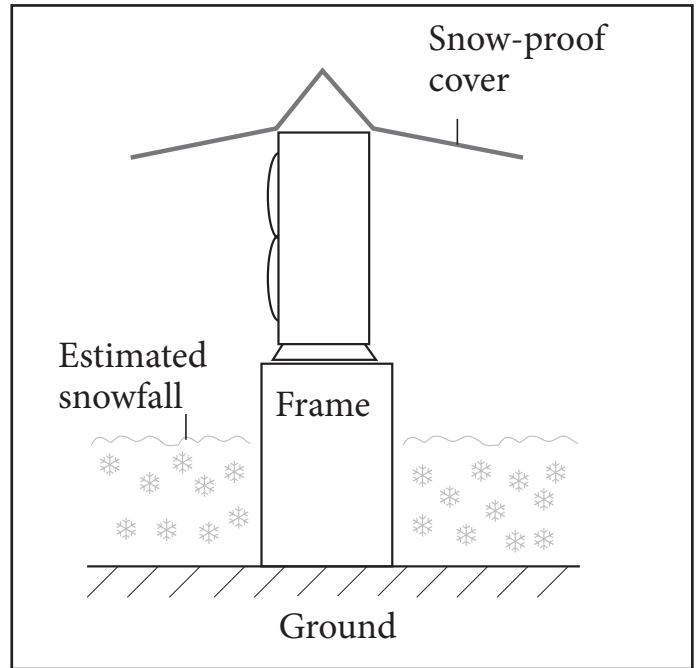

4.15 POSITIONING THE UNIT IN A RIGID CLIMATE.

To operate the appliance in low temperature outside environmental conditions, follow the instructions below.



- To avoid exposure to wind, install the unit with the intake side facing the wall.
- Do not install the unit in a place where the intake side can be directly exposed to the wind.
- To avoid exposure to the wind, install a deflector on the air exhaust side of the unit.
- In areas subject to heavy snowfalls, it is particularly important to choose an installation site where snow does not affect the unit. If lateral snowfall is possible, make sure that the heat exchanger coil is not affected by the snow (if necessary, build a side snow cover)

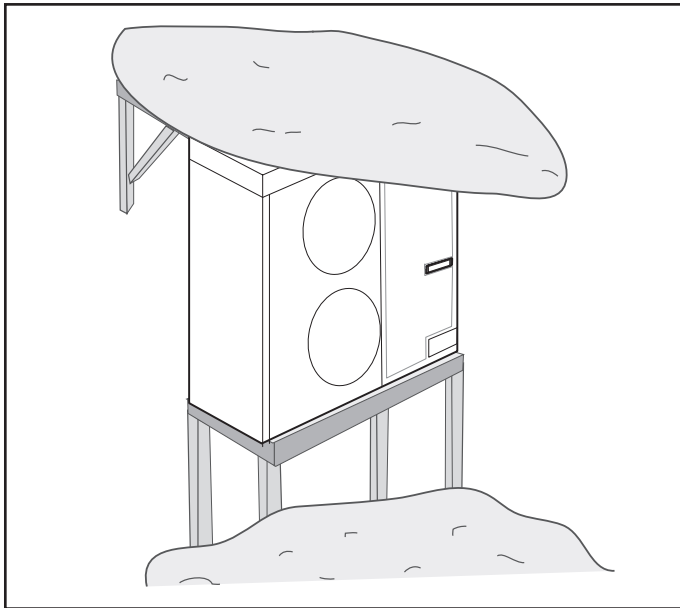

1. Build a large cover.
 2. Build a pedestal.
- Install the unit high enough above the ground so that it cannot be buried in the snow.

- The fan inside the outdoor unit runs regularly by actuating the “K6 ON” switch, as established, to prevent snow from building up inside the outdoor unit.
- The outdoor unit must be installed considering the direction of strong winds. These can turn the unit. Therefore the side of the unit, and not the front, should face the wind.

UE HYDRO HP5

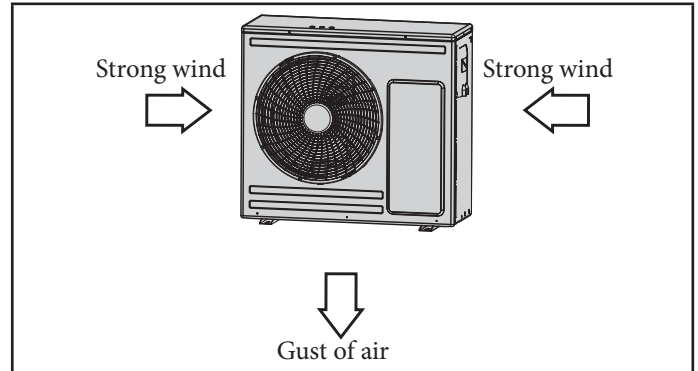

UE HYDRO HP8-12

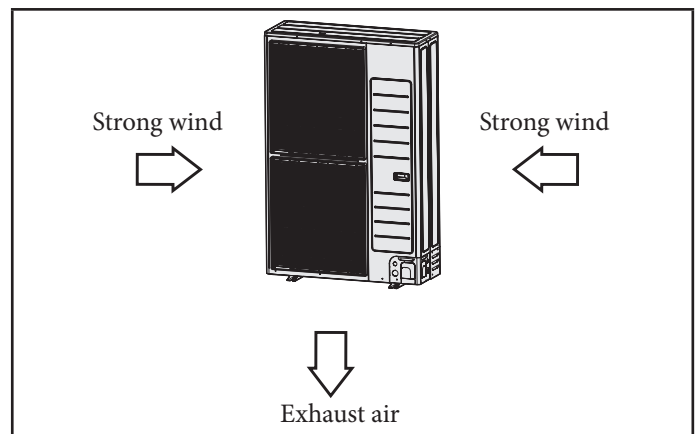



5 ELECTRICAL CONNECTIONS.

5.1 GENERAL CONFIGURATION OF THE SYSTEM.

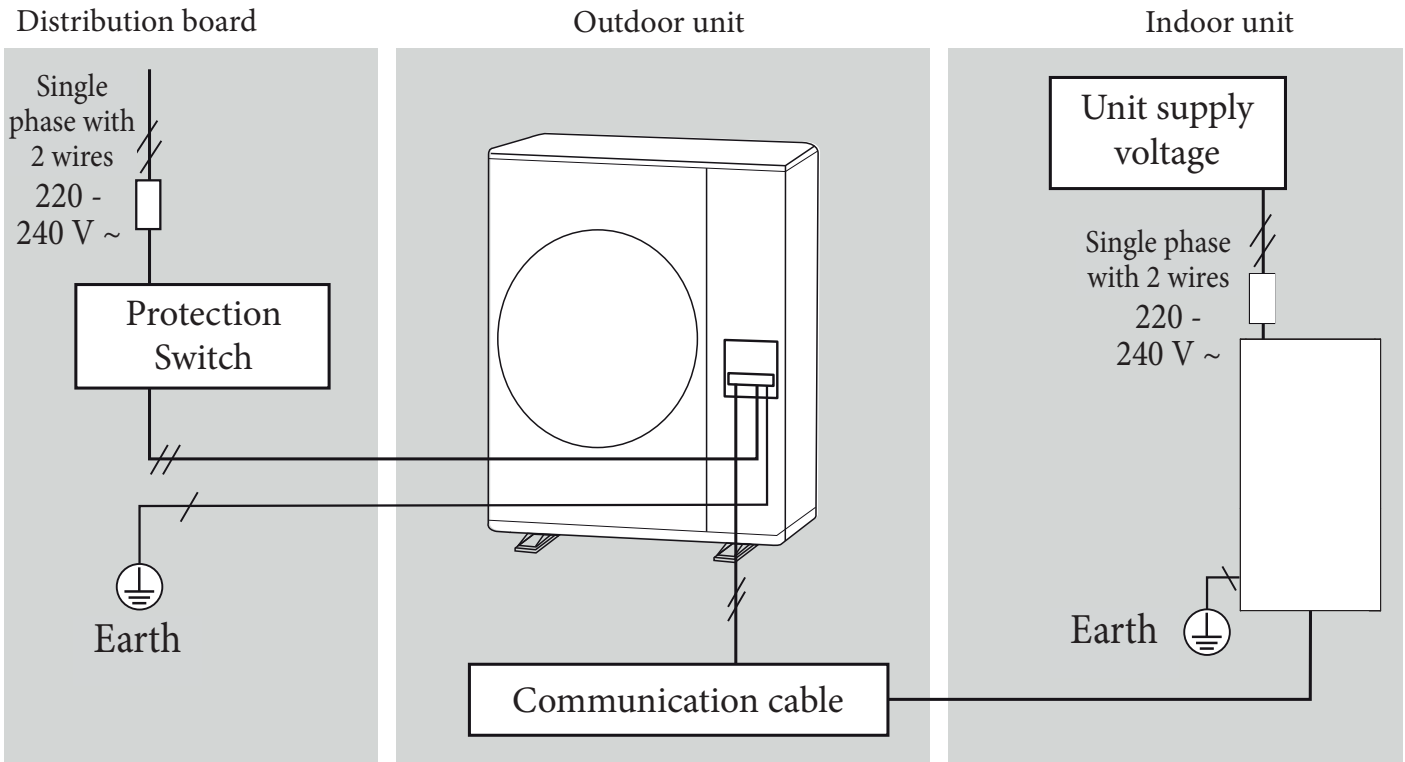
Connection of power cable (single phase 2 wires)



ATTENTION:

- Install the electrical panel close to the outdoor unit to make servicing and emergency operation convenient. 
- Make sure to install the switch with protection against overcurrent and electric leakage. 

6 CONNECTING THE CABLE.

6.1 POWER SUPPLY CABLE SPECIFICATIONS.

Outdoor unit	Rated		Voltage interval		MCA	MFA
	Hz	Volt	Min	Max	Amp. Min. Circuit	Fuse Max. Amp. Fuse
UE HYDRO HP5	50	220-240	198	264	16.0 A	20.0 A
UE HYDRO HP8	50	220-240	198	264	22 A	27.5 A
UE HYDRO HP12	50	220-240	198	264	28 A	35 A

- The power cable is not supplied with the heat pump.
- The power cables of parts of the outdoor appliances must be lighter than the flexible cables with polychloroprene sheath (designation code IEC:60245 IEC 57 / CENELEC:H05RN-F).
- This appliance complies with standard IEC 61000-3-12.

6.2 SPECIFICATIONS OF CONNECTING CABLES.

Power supply	Max/Min (V)	Communication cable
1Φ, 220-240 V ac, 50 Hz	±10%	0.75 mm ² , 2 wires

- Use H07RN-F or H05RN-F grade materials for the connection cable.

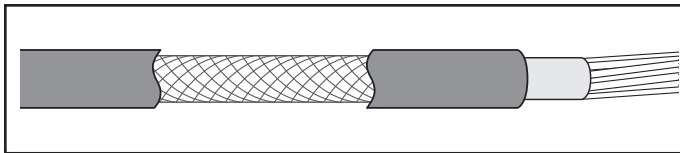

- If the outdoor unit is installed in a computer room, network room, server room or where there is a risk of disturbance of the communication cable, use a double-shielded communication cable (aluminium tape / polyester + copper braid) type FRO-HH2R.

6.3 SPECIFICATIONS OF SINGLE-PHASE TERMINAL BLOCK.



UE HYDRO HP 5		UE HYDRO HP 8-12	
AC power supply : M4 screw	Communication : M4 screw	AC power supply : M5 screw	Communication : M4 screw

6.4 POWER CABLE CONNECTION DIAGRAM.

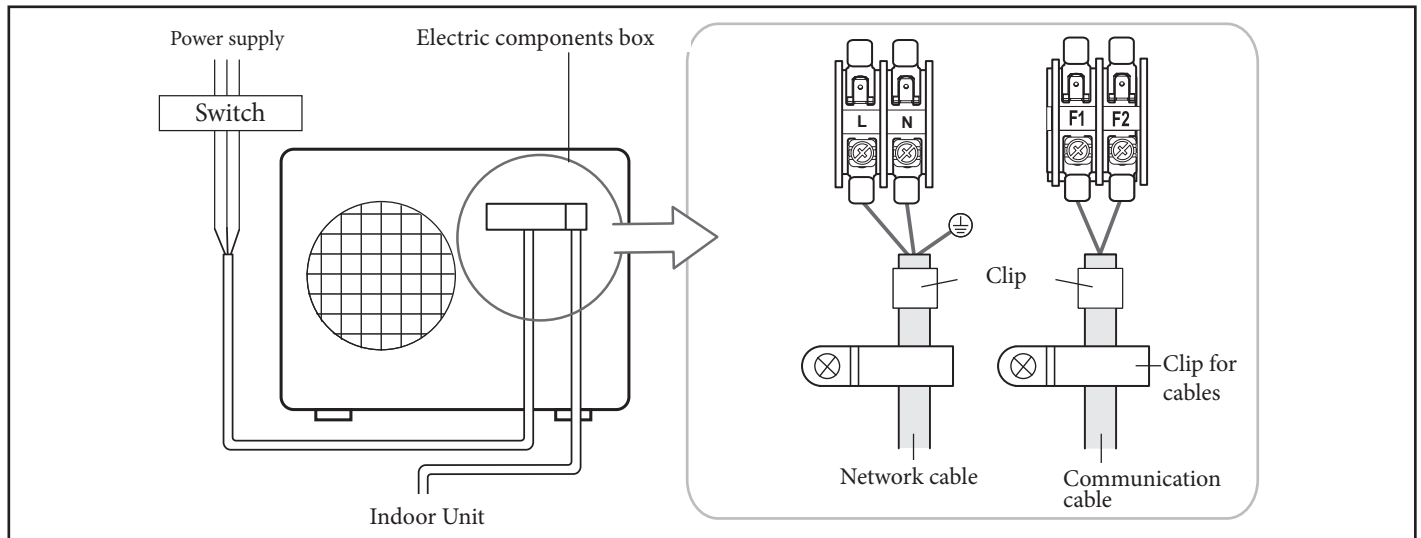
When using an earth leakage breaker (ELB) for a single-phase system.





ATTENTION:

- The power cable must be connected to the relative terminal and secured with a clip.  
- Power imbalance must not exceed 2% of the rated voltage.
- If the imbalance is higher, the life of the capacitor could be shortened. If the power imbalance exceeds 4% the supply power, the indoor unit protection trips, the unit stops and the error mode is indicated.
- To protect the product against water and blows, the power cable and the connection cable of the indoor and outdoor units must be laid in conduits. (With an adequate protection rating IP and choice of materials for the application made)
- Check that the main power connection is performed by means of a switch which disconnects all the poles, with a contact opening of at least 3 mm.
- The devices disconnected from the electric mains must be completely disconnected in the overvoltage category condition.
- Maintain a distance of 50 mm or more between the power cable and the communication cables.

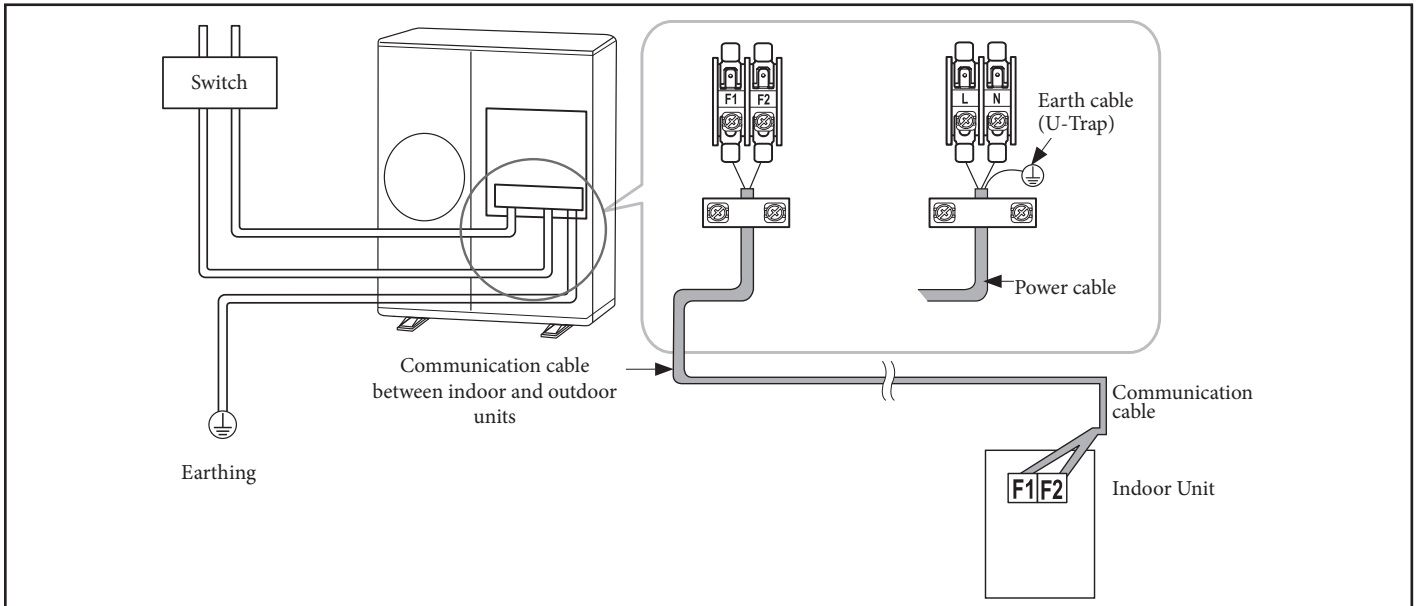
Single phase with 2 wires



ATTENTION:



- When the outer cover of the power supply cable is removed, use appropriate tools to avoid damaging the internal casing. 
- Make sure to position the outer casing of the power cable and of the communication cable at least 20 mm in electric parts. 
- The communication wiring should be made separately from the power cable and from other communication cables.

6.5 CONNECTION OF POWER TERMINAL.

- Connect the cables to the terminal block using the compressed ring terminal.
- Cover a solderless ring terminal and a part of the power supply cable connector and then connect.
- Only connect regulation tables.
- Connection using a key capable of applying the nominal tightening torque to the screws.
- In the terminal is loose, a fire could occur due to an electric arc. Overtightening the terminal could damage it.

Tightening torque (kgf.cm)	
M4	12~18
M5	20~30

ATTENTION:

- The cables can be connected through the holes below, depending on the location.  
- Prepare the transmission wiring between the indoor unit and the outdoor unit through a duct that protects it from external stresses and run the duct through the wall.
- Remove all burrs on the edge of the pre-marked hole and use an internal coating with electrical insulation, such as rubber, to fasten the cable to the pre-marked hole of the outdoor unit.
- The cable must be kept in a protective pipe.
- Keep a distance of 50 mm or more between the power supply cable and the communication cables.
- When the cables have been connected through the hole, remove the bottom of the plate

Cable nominal size [mm ² (inches)]		4/6 (0.006/0.009)	10 (0.01)	16 (0.02)	25 (0.03)	35 (0.05)	50 (0.07)	70 (0.10)			
Screw nominal size [mm(inches)]		4 (3/8)	8 (3/16)	8 (3/16)	8 (3/16)	8 (3/16)	8 (3/16)	8 (3/16)			
B	Standard size [mm (inches)]	9.5 (3/8)	15 (9/16)	15 (9/16)	16 (10/16)	12 (1/2)	16.5 (10/16)	16 (10/16)	22 (7/8)	22 (7/8)	24 (1)
	Tolerance [mm (inches)]	±0.2 (±0.007)		±0.2 (±0.007)	±0.2 (±0.007)	±0.3 (±0.011)		±0.3 (±0.011)		±0.3 (±0.011)	±0.4 (±0.011)
D	Standard size [mm (inches)]	5.6 (1/4)		7.1 (1/4)	9 (3/8)	11.5 (7/16)	13.3 (1/2)	13.5 (1/2)	17.5 (11/16)		
	Tolerance [mm (inches)]	0.3 (0.011)	0.2 (0.007)	0.3 (0.011)	0.3 (0.011)	0.3 (0.011)	0.5 (0.019)	0.2 (0.007)	0.5 (0.019)	0.5 (0.019)	0.5 (0.019)
d1	Standard size [mm (inches)]	3.4 (1/8)		4.5 (3/16)	5.8 (1/4)	7.7 (5/16)	9.4 (3/8)	11.4 (7/16)	13.3 (1/2)		
	Tolerance [mm (inches)]	±0.2 (±0.007)		±0.2 (±0.007)	±0.2 (±0.007)	±0.2 (±0.007)		±0.2 (±0.007)		0.3 (0.011)	±0.4 (±0.015)
E	Min. [mm (inches)]	6 (1/4)		7.9 (5/16)	9.5 (5/16)	11 (3/8)	12.5 (1/2)	17.5 (11/16)	18.5 (3/4)		
F	Min. [mm (inches)]	5 (3/16)	9 (3/8)	9 (3/8)	13 (1/2)	15 (5/8)	13 (1/2)	13 (1/2)	14 (9/16)	20 (3/4)	
L	Max. [mm (inches)]	20 (3/4)	28.5 (1-1/8)	30 (1-3/16)	33 (1-5/16)	34 (1-3/8)		38 (1-1/2)	43 (1-11/16)	50 (2)	51 (2)
d2	Standard size [mm (inches)]	4.3 (3/16)	8.4 (1-3/16)	8.4 (1-3/16)	8.4 (1-3/16)	8.4 (1-3/16)		8.4 (1-3/16)		8.4 (1-3/16)	8.4 (1-3/16)
	Tolerance [mm (inches)]	+0.2 (+0.007)	+0.4 (0.015)	+0.4 (0.015)	+0.4 (0.015)	+0.4 (0.015)	+0.4 (0.015)	+0.4 (0.015)	+0.4 (0.015)	+0.4 (0.015)	+0.4 (0.015)
t	Min. [mm (inches)]	0.9 (0.03)		1.15 (0.04)	1.45 (0.05)	1.7 (0.06)		1.8 (0.07)		1.8 (0.07)	2.0 (0.078)

ATTENTION:

- For products which use refrigerant R-32, avoid generating sparks by following the instructions below:
- Do not remove the fuses while the unit is on.
- Do not unplug the unit while it is on.
- It is recommended to install the outlet high up. Lay the cables in such a way that they do not get tangled.



6.6 INSTALLATION OF EARTHING WIRE.

- Earthing must be safely performed by the installer technician.
- Use the earth wire referring to the specifications of the electric cable from the outdoor unit.

Power cable earthing

- Earthing standards may vary depending on the voltage and rated voltage of the place of installation of the condensing unit.
- Earth the power cable as follows.

Place of installation	High humidity	Average humidity	Low humidity
Power condition			
Electric potential lower than 150 V		Perform earthing in mode 3 (Note 1)	If possible, perform earthing in mode 3 for enhanced safety. (Note 1)
Electric potential higher than 150 V		Earthing must be carried out in mode 3 (Note 1) (In case of installation of a circuit breaker)	



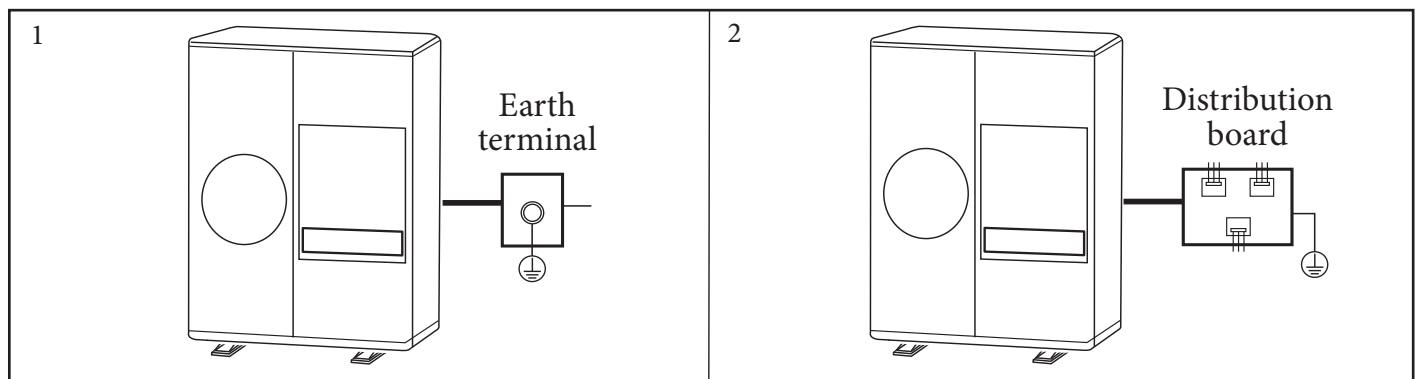

- (Note 1) Earthing work 3.
- Earthing must be carried out by the installer technician.
- Check whether the earth resistance is lower than 100Ω. When a circuit breaker is installed which can interrupt the electric circuit in case of a short circuit, the admissible earth resistance can be 30 ~ 500Ω.

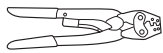

- 1) When using only the earthing terminal.
- 2) When earthing the electrical panel.

6.7 HOW TO CONNECT POWER SUPPLY EXTENSION CABLES.

1. Prepare the following instruments:

Tools	Crimping pliers	Connection sheath (mm)	Electrical tape	Contraction sheath (mm)
Specifications	MH-14	20xØ6,5 (HxD.E.)	Width 19 mm	70xØ8,0 (LxD.E.)
Shape				

2. As shown in the figure, strip the screen from the rubber and from the wire of the power supply cable.

- Strip 20 mm the cable screening from the preinstalled sheath.

ATTENTION:



- For information on power cable specifications for outdoor and indoor units, please refer to the instruction manual.
- After removing the cable wires from the pre-installed pipe, it is necessary to insert a heat shrink pipe.

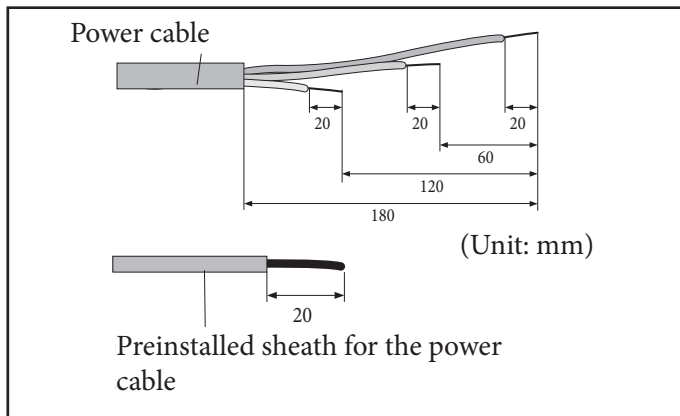

3. Insert both terminals of the copper wire of power cable into the connection sheath.

Method 1

- Push the copper wire into the sheath from both sides.

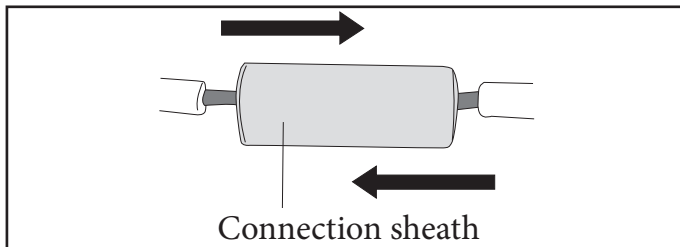

Method 2

- Twist the copper wires together and push them into the sheath.

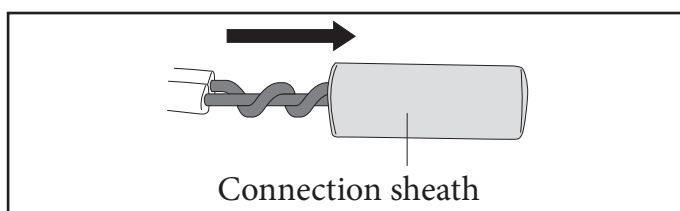

ATTENTION:

If no connection sleeves are used to connect the cable wires, the contact area will be reduced or the external surfaces of the wires will tend to corrode (copper wires) over time. These processes can entail an increase in resistance (reduction of the let-through current) and, as a result, cause fires.



4. Compress the two points with the crimping pliers, turn them and repeat the operation on the other two points in the same position.

- The compressed dimension should be 8.0.
- After having squeezed it, pull both ends of the wire to make sure it is firmly compressed.

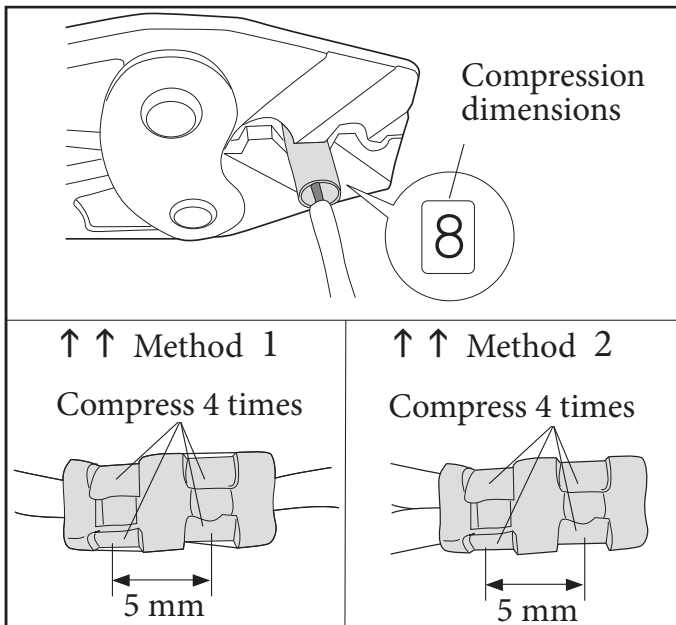

5. Heat the shrink pipe so that it will contract.

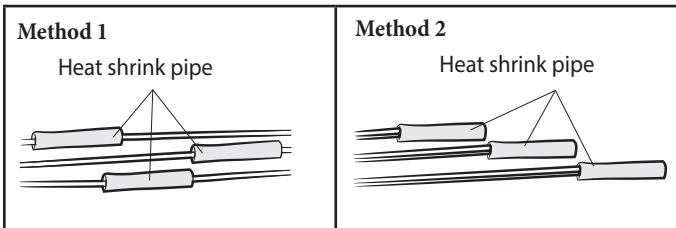

6. Cover two or more times with electrical tape and place the heat shrink sheath in the middle of the electrical tape.

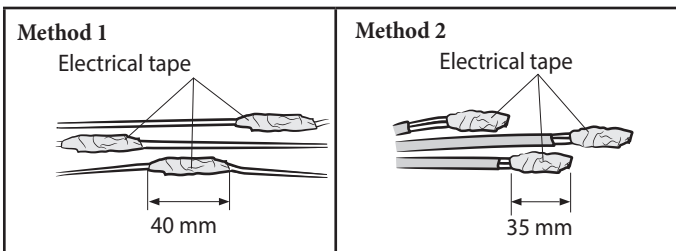

7. At the end of the contraction pipe operation, wrap the pipe with electrical tape. Three or more layers of tape are required.

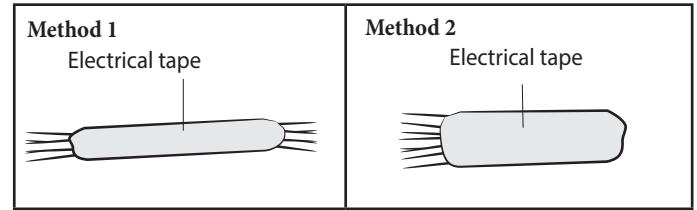

ATTENTION:

- Make sure that the parts to be connected are not exposed to the outside.
- Make sure that the electrical tape and the contraction sheath are made with approved reinforced insulating materials with the same voltage and current values as the power cable. (Comply with local standards for the extensions).



ATTENTION:

- In case of extension of the electric wire, do NOT use a round press-fit bushing.
- Incomplete electrical connections can cause electrocutions or fire.

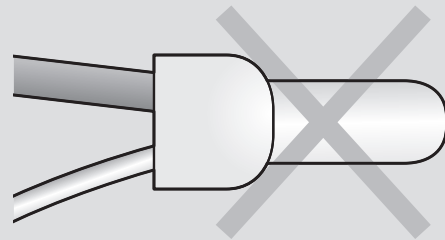
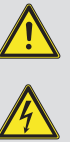

7 PROPER EARTHING CHECK.

If the electric distribution circuit is not earthed or earthing does not comply with the specifications, an earthing system must be installed. The corresponding accessories are not supplied with the condensing unit.

1. Select an earthing electrode compliant with the specifications indicated in the figure.

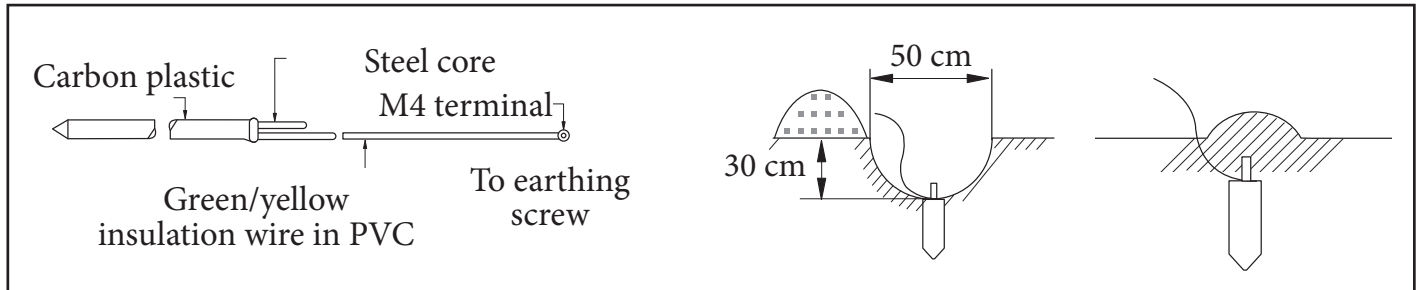

2. Connect the flexible hose to the coupling.

- Preferably on a hard or moist ground rather than sandy or gravelly due to the greater earth resistance.
- Away from structures or underground structures, such as gas pipes, water pipes, telephone lines or buried cables.
- At least 2 m from a lightning conductor and from its cable.

- The earth wire for the telephone line cannot be used to earth the condensing unit.



3. Finish by wrapping electrical tape around the pipes in the direction of the outdoor unit.

4. Install a green/yellow earth wire:

- If the earth wire is too short, mechanically connect an extension cable and wrap it with electrical tape (do not bury the connection).
- Secure the earthing cable in position with appropriate anchors.

- If the earthing electrode is installed in an area with heavy traffic, its wire must be connected securely.



5. Carefully check the installation by measuring the earth resistance with an ohmmeter. If the resistance is higher than the required level, plant the electrode deeper into the ground or increase the number of earthing electrodes.

6. Connect the earthing cable to the electric components box inside the outdoor unit.

8 PIPE IMPLEMENTATION.

The hydraulic connections must be carried out according to the general diagram supplied with the unit, observing the inlet and outlet of the water. If any air, humidity or dust penetrate the water circuit, problems may occur. Therefore, always keep the following in mind when connecting the water circuit:

- Use clean pipes only.
- Keep the end of the pipe down while removing burrs.
- When inserting the end of a pipe into a wall, cover it in order to prevent dust and dirt from penetrating.
- Use a good fitting sealant to seal the connections. The fitting sealant must be able to withstand the system's pressures and temperatures.
- When non-brass metal pipes are used, make sure the two materials are insulated from each other to avoid galvanic corrosion.
- Since brass is a soft material, use suitable tools to connect the hydraulic circuit. Unsuitable tools can damage the pipes.

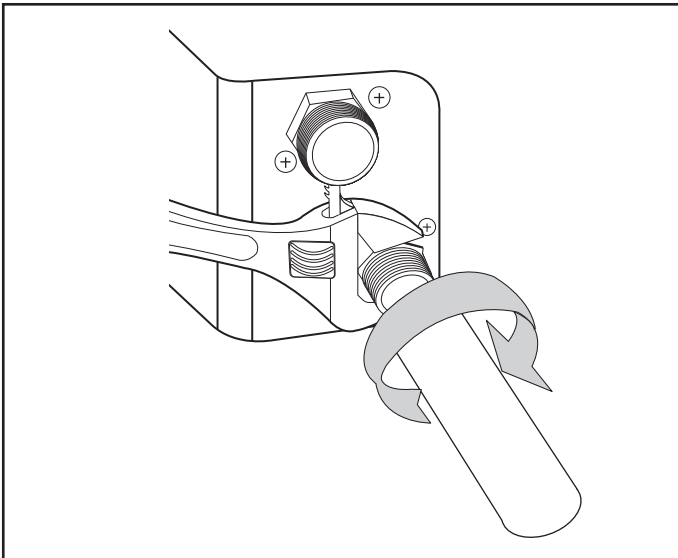

ATTENTION:



- **Be careful not to deform the unit's pipes by exerting excessive force when connecting the pipes. Deformed pipes may cause the unit to malfunction.**
- **Always use two spanners (wrenches) to tighten or loosen the hydraulic connections; tighten the connections with a torque wrench as specified in the following table. Otherwise, the connections and parts can be damaged and leak.**
- **The unit can be used in a closed water system only. If applications are made in an open water circuit, encrustations, corrosion and leaks will be generated on the heat exchangers.**

	Name	Tightening torque	
1	BSPP1	350 ~ 380 kgf•cm	34 ~ 37 N•m

8.1 AIR WASH AND PURGE.

When topping up the water, the following start-up procedure should be followed.

1. All system components and pipes should be tested for leaks.
2. It is recommended to prepare a washing unit for the refill water during installation and maintenance.
3. Before connecting the pipes to the outdoor unit, use a washing unit or tap water pressure, if appropriate (i.e., at least 2 bars), to drain the water pipes completely in order to remove contaminants.
4. Top up the water in the outdoor unit by opening the shut-off and drain valve.
5. Purge the air. (To top up, use a washing unit with sufficient flow rate: avoid aerating the water)
6. Circulate the water long enough to ensure that all air is eliminated from the whole water pipe system.



Washing unit
(or purge carriage)

ATTENTION:

After installation, start-up should be performed by qualified personnel. If the air is not properly washed and purged, malfunctions may occur.



ATTENTION:

Before installing/starting up the unit, make sure you have checked the following points:

- The unit's maximum water static pressure is 2.9 bars.
- The quality of the water must comply with EC directive 98/83.
- If the unit and pipes are exposed to a freezing temperature, this can damage the hydraulic system. Pay special attention to avoid freezing the whole water system.



ATTENTION:

- The unit is designed for use in a closed circuit system. Do not use other components designed only for an open circuit system.
- Do not use any galvanised parts in the water circuit.
- All hydraulic components, including any pipes not supplied, must be insulated to reduce heat loss and condensate.
- Provide drain taps at all low points of the system for the circuit to be drained completely in case of maintenance.
- Wash the pipes with clean water to remove any contaminants that penetrated them during installation.
- Periodically clean the water filter after washing the pipes. Replace the filter as needed.



ATTENTION:

- If the water pipes are located in a higher position than the unit's air inlet, add an additional one in the highest position of the water circuit. Fit the air inlet where the water temperatures and pipe height are higher.
- Always use materials that are compatible with the water used in the system and with the materials used in the indoor unit.
- Select the pipes' diameters according to the required water flow.
- Use chemical cleaners (start with acids and end with alkalis).
- Do not use the system with closed valves as this could damage the heat pump.



Difference in installation height (a)	Water volume	
	< 220 litres	> 220 litres
< 7 m	No pre-charged pressure adjustment is required	Required actions: -The pre-charged pressure must be decreased; calculate it based on the "Calculation of the expansion vessel's pre-charged pressure". -Check whether the water volume is lower than the maximum allowed value.
> 7 m	Required actions: The pre-charged pressure must be increased; calculate the appropriate value based on the "Calculation of the expansion vessel's pre-charged pressure". Check whether the water volume is lower than the maximum allowed volume.	Unit expansion vessel too small for installation.

(a) Installation level difference: height difference (m) between the highest point of the hydraulic circuit and the indoor unit. If the unit is installed at the highest point of the system, the mounting height is considered to be 0 m.

To achieve reliable performance, the water volume of the whole system must be at least 30 litres (UE HYDRO HP5 - 8) and 50 litres (UE HYDRO HP12).

Calculation of the expansion vessel's pre-charged pressure

The pre-charged pressure (Pg) to be set depends on the maximum difference in the installation height (H) and is calculated as follows:

$$P_g = (H/10 + 0.3) \text{ bar}$$

8.2 HEAD LOSSES OF THE OUTDOOR UNIT BASED ON GLYCOL CONCENTRATION.

The unit essentially consists of water pipes and a plate heat exchanger.

To ensure proper operation of the unit and predict its performance, the “Flow Rate - Head Losses” table can be used. The “Flow rate - Head Losses” characteristic curve depends on glycol concentration.

UE HYDRO HP5

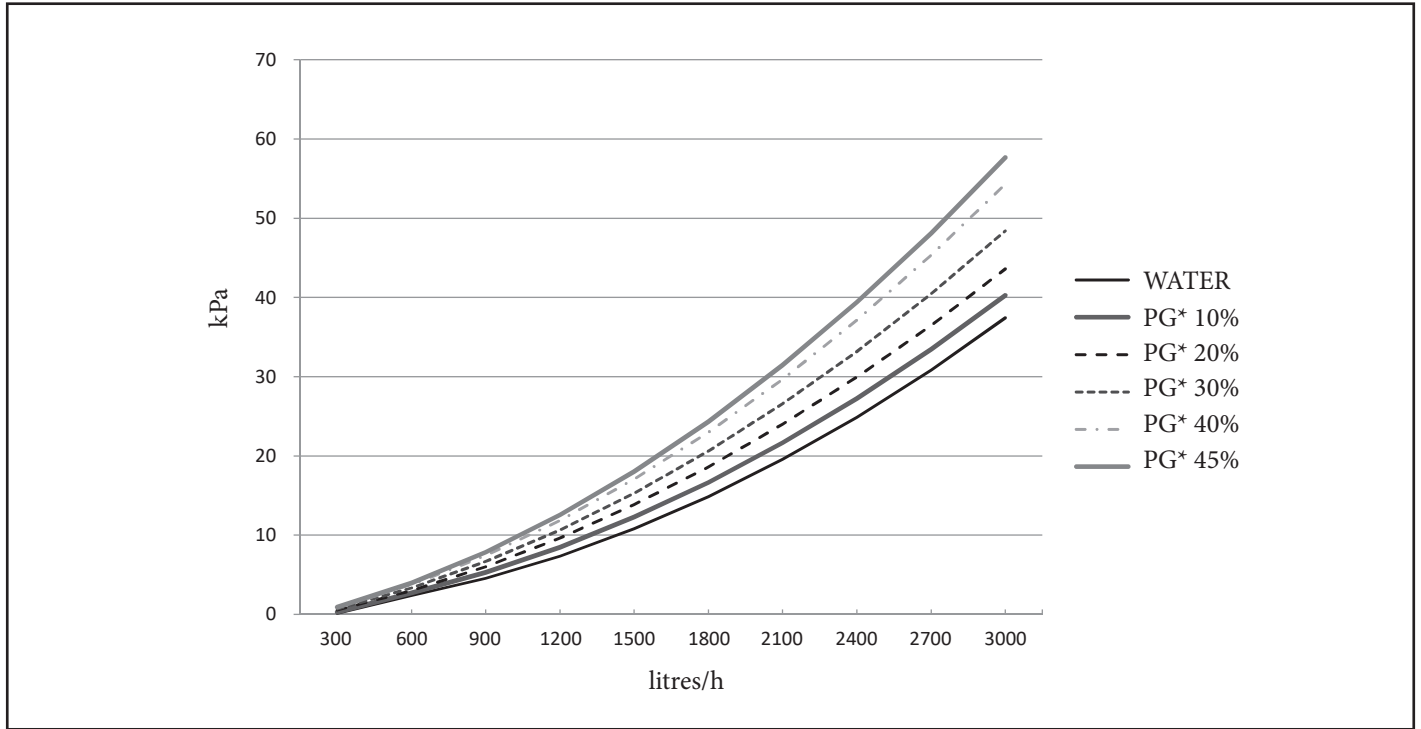

*PG= Glycol percentage

UE HYDRO HP8

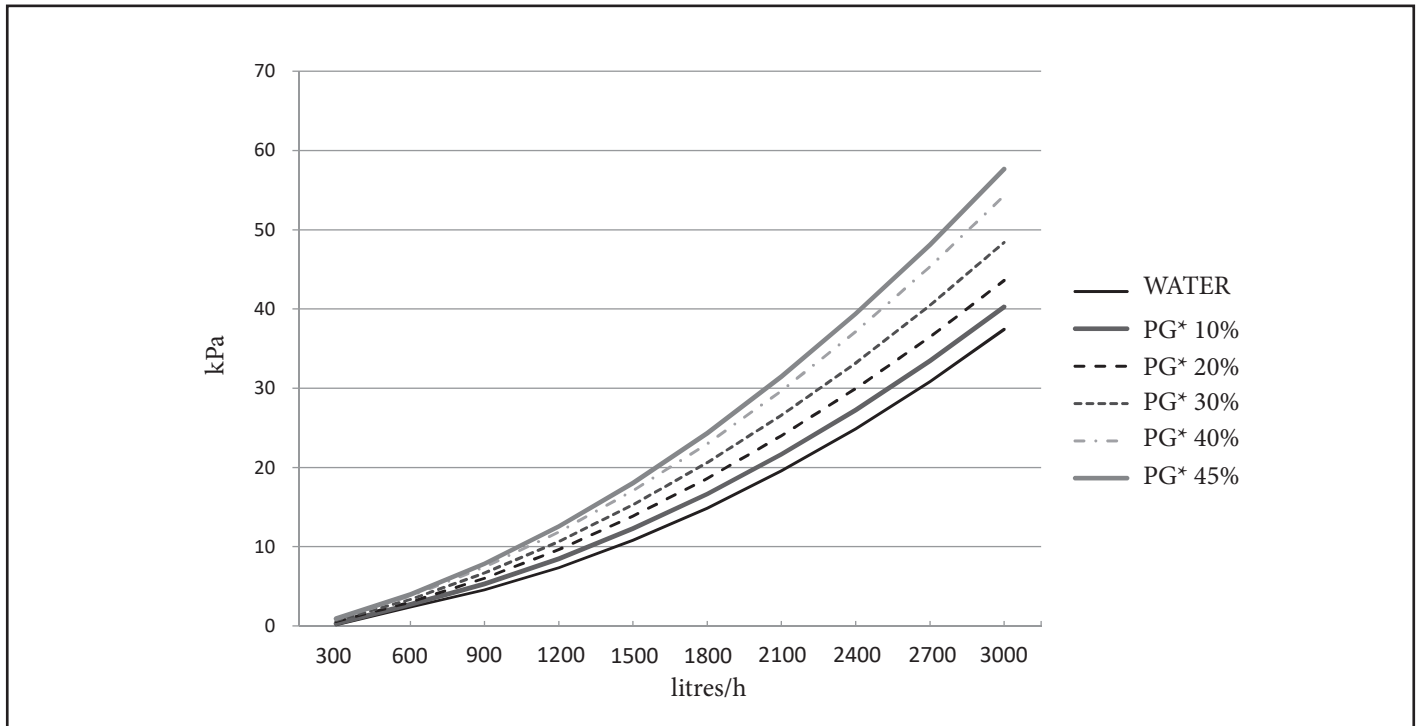

*PG= Glycol percentage

UE HYDRO HP12

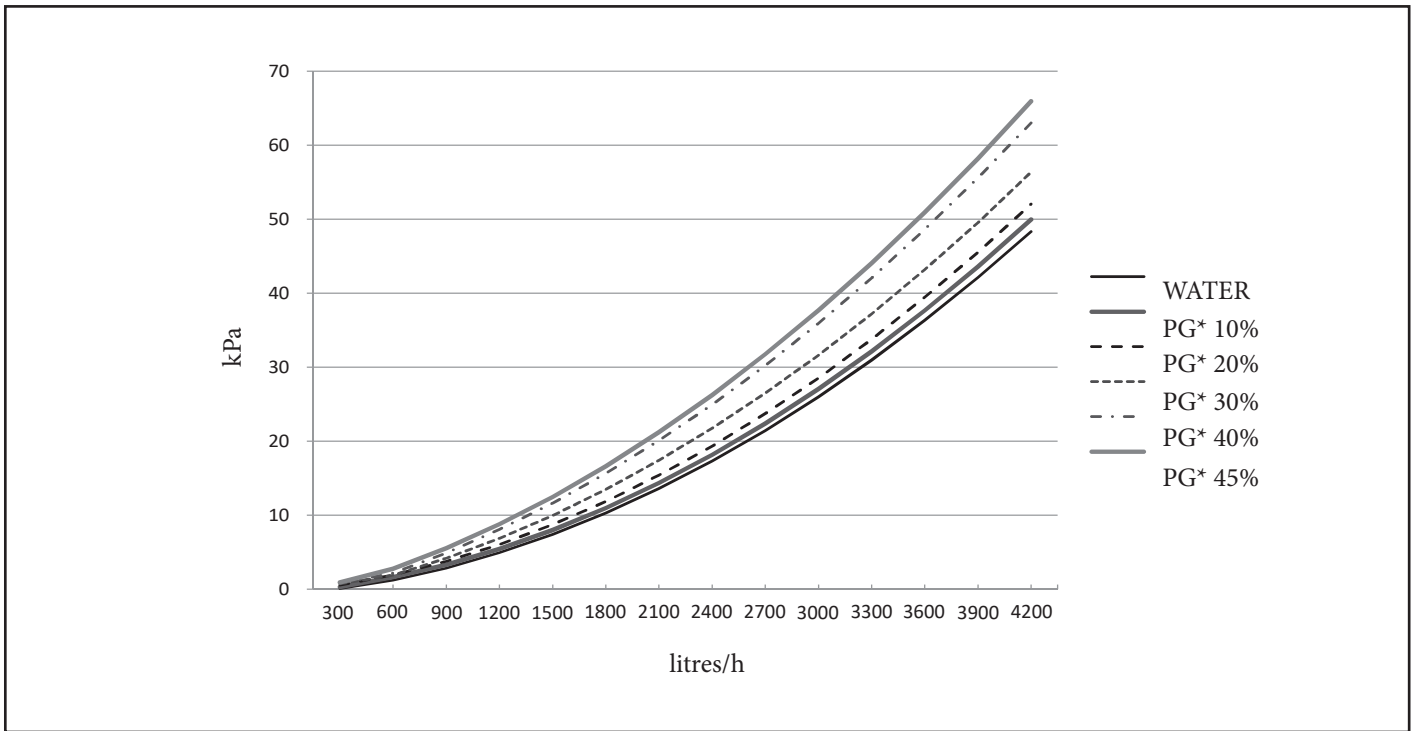

*PG= Glycol percentage

Changing the glycol concentration can cause the system to drop in pressure and this can make the flow rate quite slow. If there is a reduction in performance, the installer should take into account any flow rate variations.

8.3 WATER LOADING.

Refer to the indoor unit's instruction manual



UE HYDRO HP5

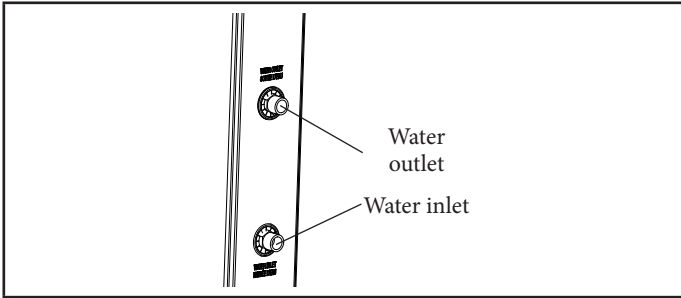

UE HYDRO HP8

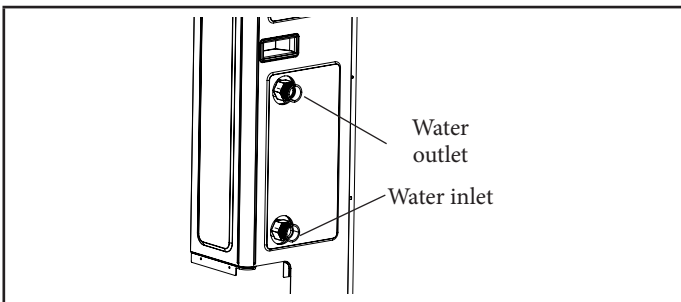

UE HYDRO HP12

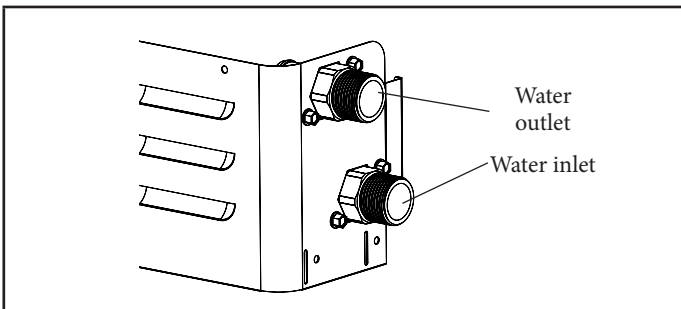

ATTENTION:



- To perform maintenance, enough free space must be available.
- The water pipe and connections must be cleaned using water or a cleaner before operating the unit for the first time.
- Considering the performance of the EXP.V. and of the water pump, select the specifications for the hydraulic pipes and floor laths.

ATTENTION:



- Be sure to properly calculate the overall resistance of the pipes and determine the size of the pipes. If the pressure loss in the whole water system is higher than the design pressure, an outdoor water pump must be installed in the standard pipe system.
- Do not connect the power supply while loading the water.
- If initial installation or reinstallation is required, use the vent valve to remove any air in the water pipes installed by local installers, so as to prevent air from being trapped in the system during water loading.
- Make sure that the device that prevents the return flow (check valves) is installed on the main feed line to avoid contaminating the public water.
- It is recommended to install a refill water unit to prevent public water contamination.
- The check valves in the refill water unit can prevent the water flowing in the outdoor unit from contaminating the water feed lines during installation or maintenance work.

8.4 PIPE INSULATION.

The whole water circuit, including all pipes, must be insulated to prevent not only condensate formation during operation and heating and cooling capacity reduction, but also freezing of outdoor water pipes during winter. The thickness of the insulating material must be no less than 9 mm (0.035 W/mK) to prevent outdoor water pipes from freezing. If the temperature and humidity are above 30° C and 80% RH respectively, the thickness of the insulating materials should be at least 20 mm to prevent any condensate build-up on the sealant surface

9 COOLING CYCLE DIAGRAM.

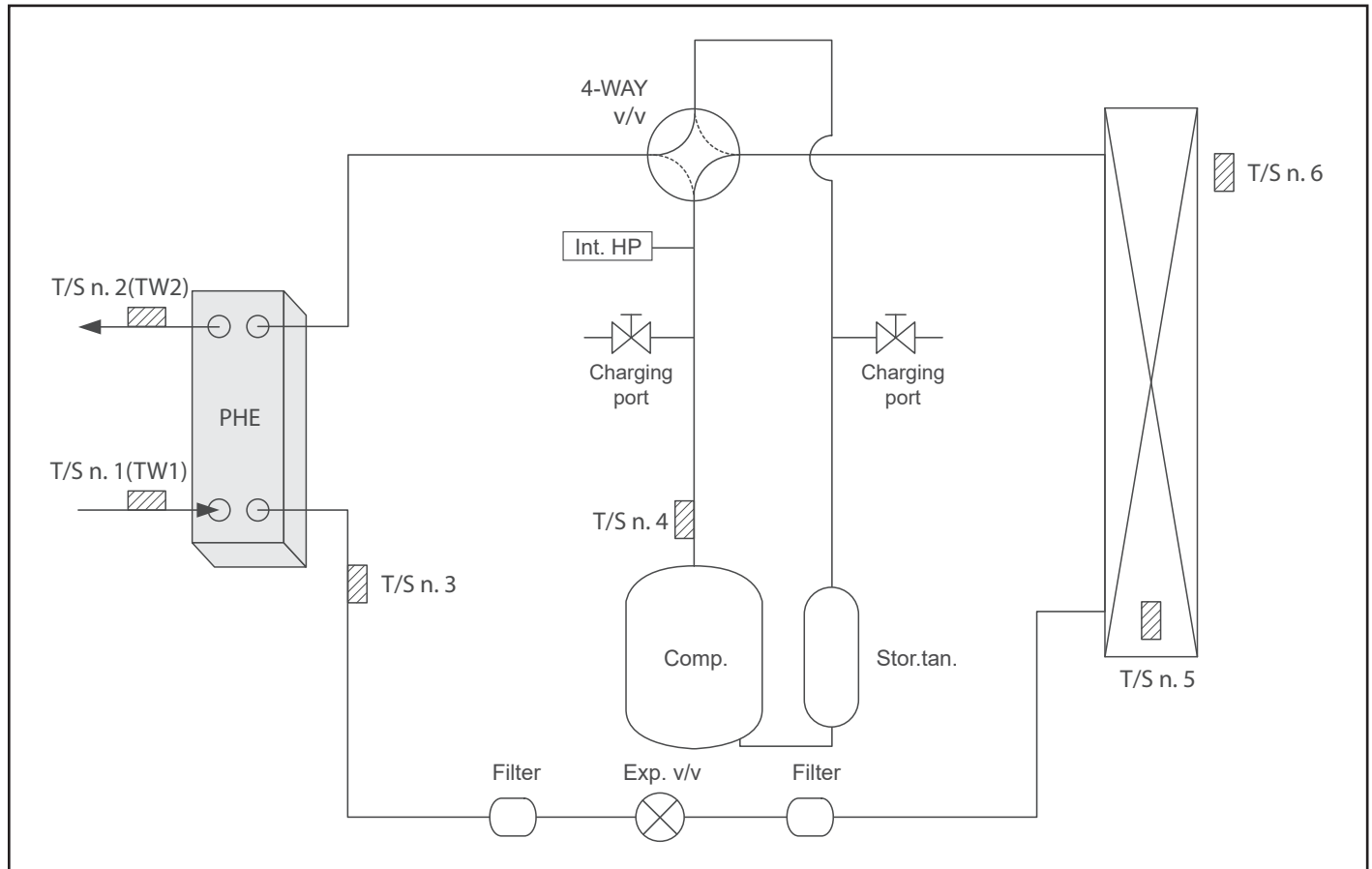

Part	Description
PHE	Plate heat exchanger (PHE)
T/S No.1	Water inlet temperature sensor
T/S No.2	Water outlet temperature sensor
T/S No.3	PHE temperature sensor
T/S No.4	Drain temperature
T/S No.5	Condenser temperature
T/S No.6	Room temperature sensor
Charging port	For the refrigerant
Stor.tan.	Storage tank

10 WIRING DIAGRAMS.

10.1 UE HYDRO HP5 WIRING DIAGRAM.

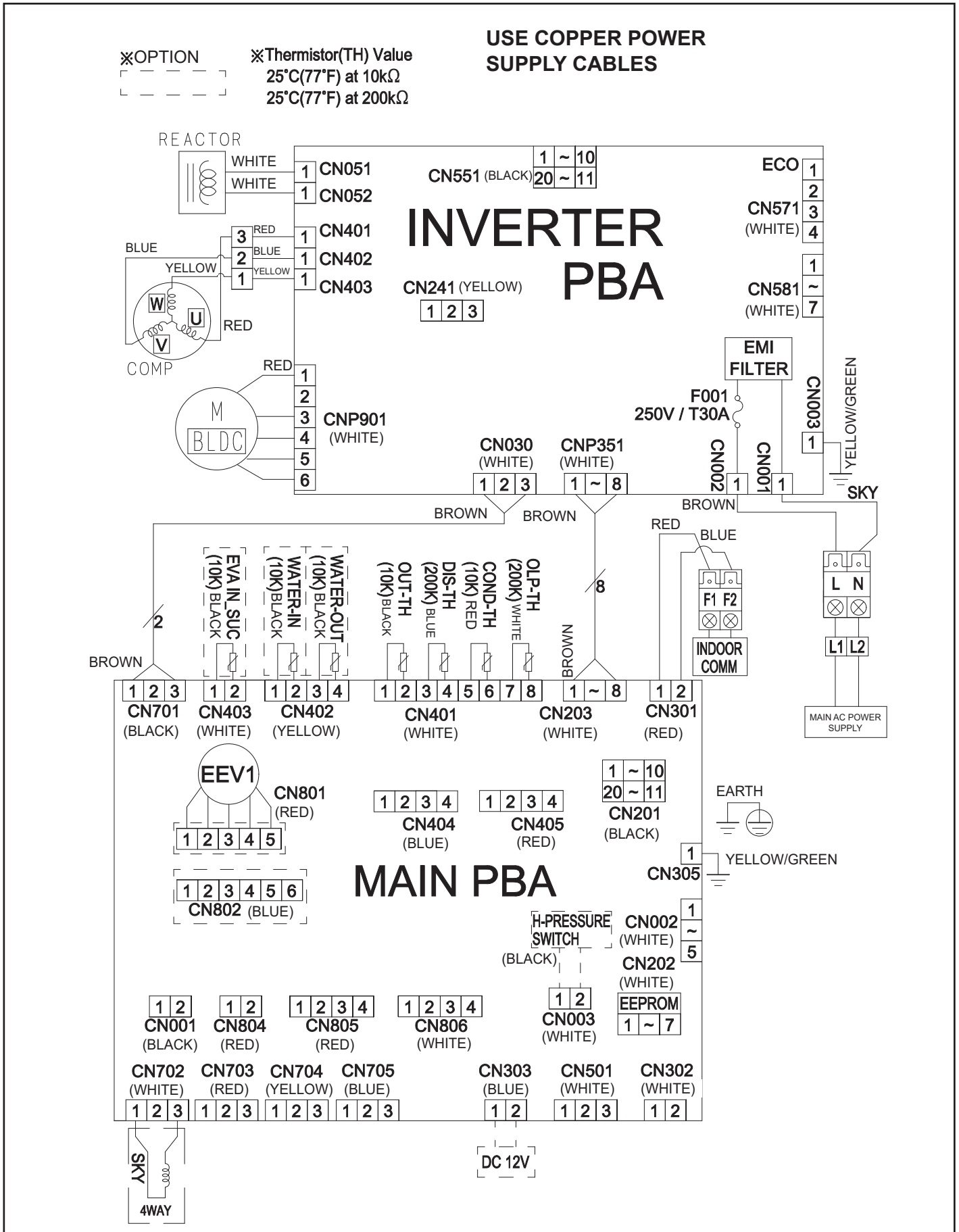

10.2 UE HYDRO HP8 WIRING DIAGRAM.

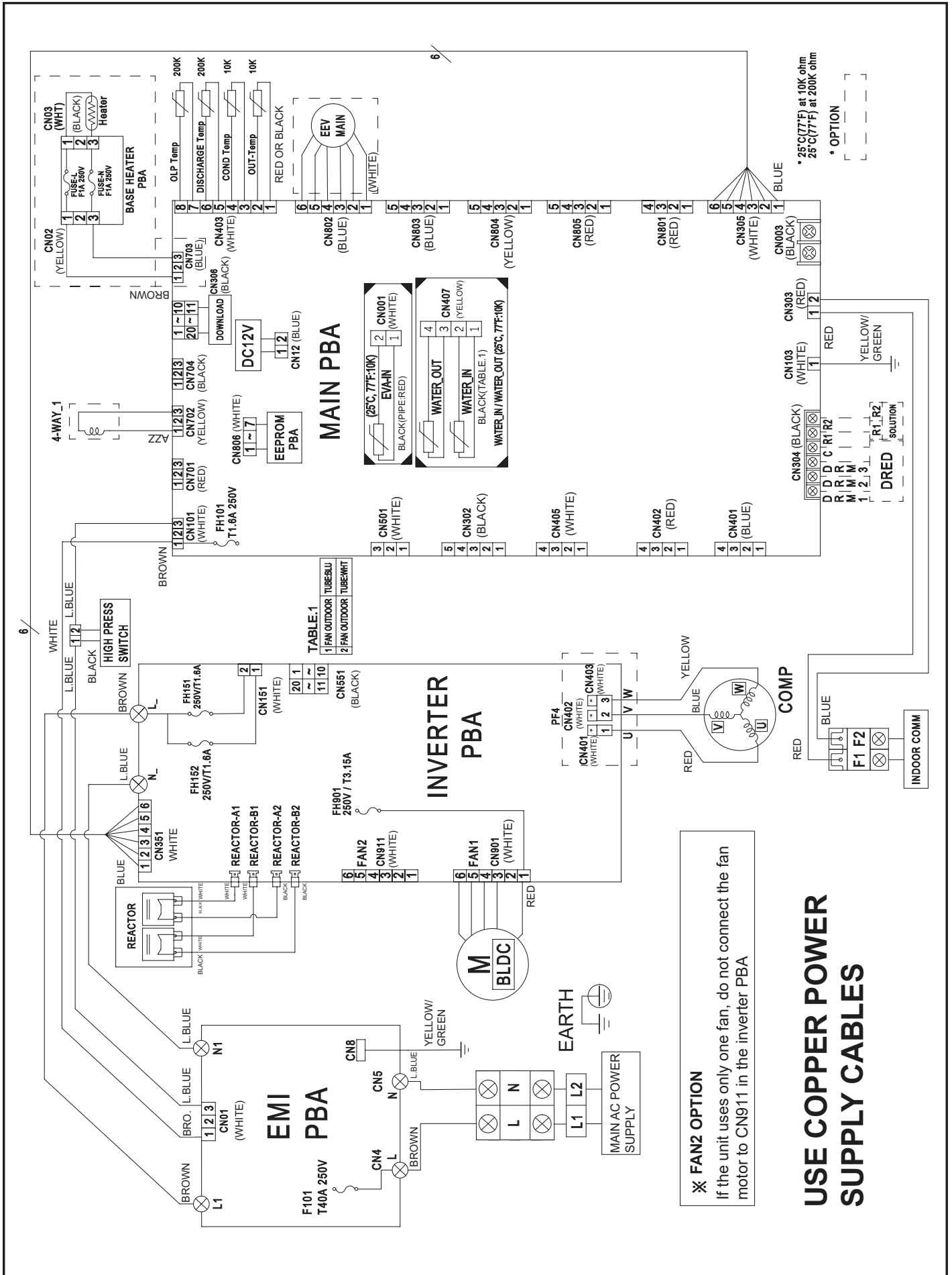

10.3 UE HYDRO HP12 WIRING DIAGRAM.

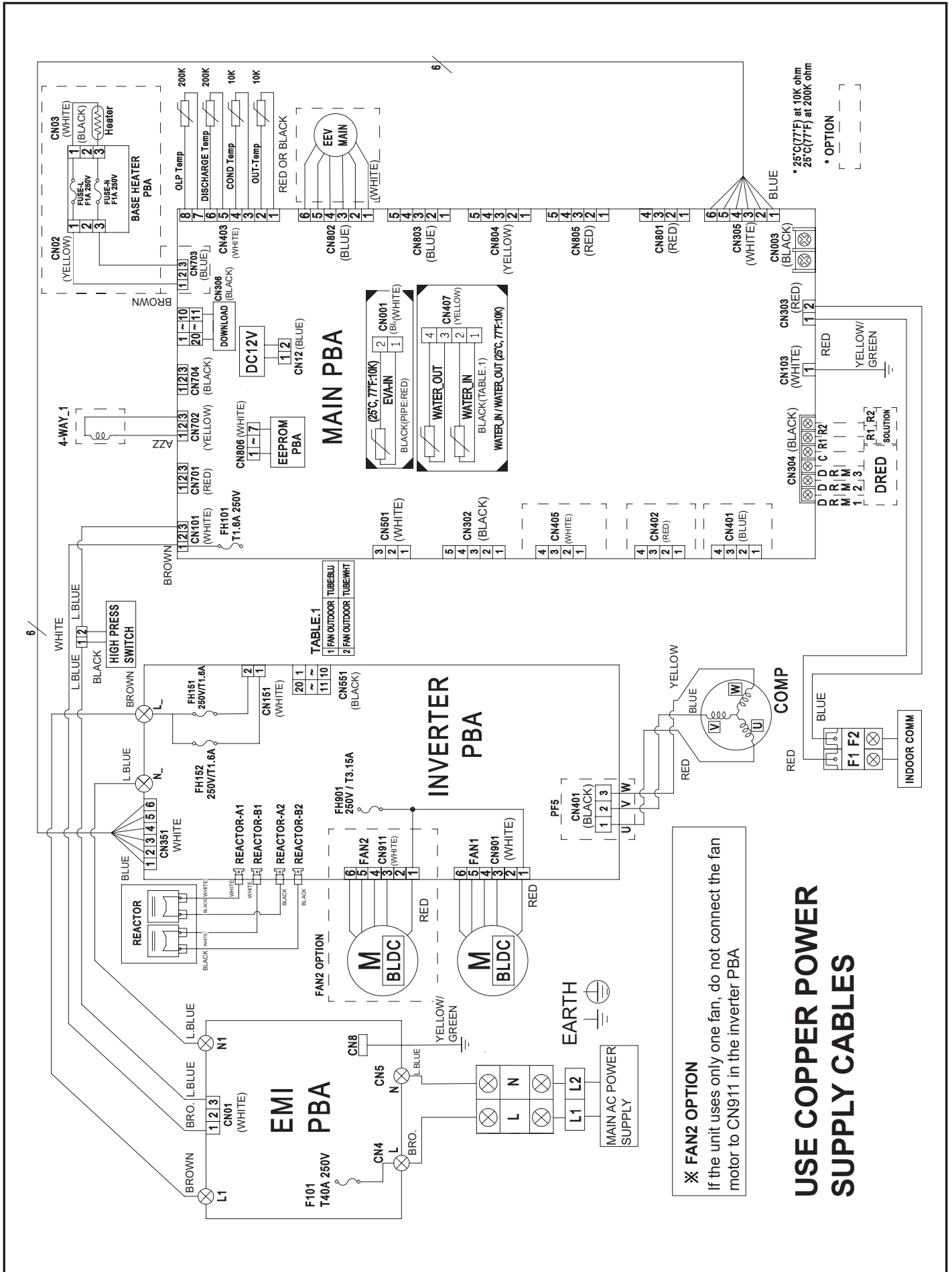

⊗ FAN2 OPTION
If the unit uses only one fan, do not connect the fan motor to CN911 in the inverter PBA

USE COPPER POWER SUPPLY CABLES

11 SETTING THE MICROSWITCHES AND KEY FUNCTIONS.

11.1 UE HYDRO HP5 TESTING OPERATIONS.

1. Check the supply voltage between the outdoor unit and the auxiliary switch.

- Single-phase power supply: L, N

2. Check that the power and communication cables have been connected properly. (If the power supply and communication cables have been swapped or connected improperly, the PCB will be damaged).

3. Press K1 or K2 on the outdoor unit board to execute the test mode and to interrupt (for the operating conditions of the indoor unit, see the relative booklet).

KEY	Operations on KEY	7-segment display
K1	Press once: Execution of heating test	"F" "7" "EMPTY" "EMPTY"
	Press twice: Execution of the defrost test	"F" "3" "EMPTY" "EMPTY"
	Press 3 times: End of test mode	-
K2	Press once: Cooling test execution	"F" "2" "EMPTY" "EMPTY"
	Press twice: Execution of outlet signal test	"F" "4" "EMPTY" "EMPTY"
	Press 3 times: End of test mode	-
K3	Reset	-
K4	View mode	Refer to display in view mode

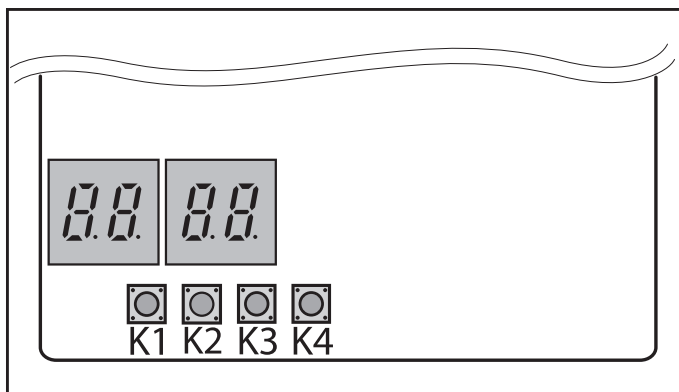
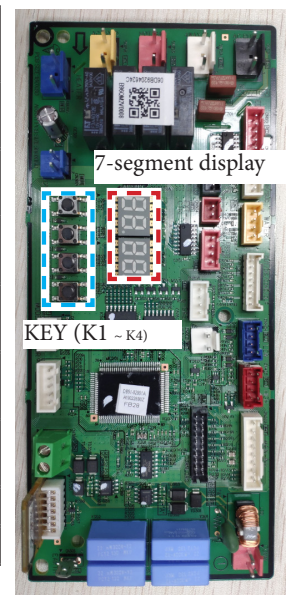

4. View mode: Press K4 to view information on the system status (K4 may not be used in Test stage).

To set the option, refer to paragraph "Setting the option" on page 44.



Number of times pressed	Contents viewed	Display				Unit
		Segment 1	Segment 2	Segment 3	Segment 4	
0	Communication status	digit of Tx tens	digit of Tx units	digit of Rx tens	digit of Rx units	-
1	Requested frequency	1	digit of hundreds	digit of tens	digit of units	Hz
2	Current frequency	2	digit of hundreds	digit of tens	digit of units	Hz
3	-	3	digit of hundreds	digit of tens	digit of units	%
4	Outdoor air temp.	4	+/-	digit of tens	digit of units	°C
5	Compress. drain temp.	5	digit of hundreds	digit of tens	digit of units	°C
6	Liquid phase sensor	6	+/-	digit of tens	digit of units	°C
7	Indoor unit return temp	7	+/-	digit of tens	digit of units	°C
8	Indoor unit flow temp.	8	+/-	digit of tens	digit of units	°C
9	Battery temp.	9	+/-	digit of tens	digit of units	°C
10	Inverter current	A	digit of tens	digit of units	First decimal	A
11	Fan RPM	B	digit of thousands	digit of hundreds	digit of tens	rpm
12	Drain temperature target	C	digit of hundreds	digit of tens	digit of units	°C
13	EEV	D	digit of thousands	digit of hundreds	digit of tens	passage
14	Protection control	E	0: Cooling 1: Central heating	Protection control 0: No protection control 1: Freezing 2: Defrosting 3: Overload 4: Supply 5: Total current	Frequency status 0: Normal 1: Maintained 2: Down 3: Upper_limit 4: Lower_limit	-
15	Inverter temp.	F	+/-	digit of tens	digit of units	°C
long -1	Main board version	Year (Decimal)	Month (Hexadecimal)	Day (Two digits)	Day (One digit)	-
long -1 and 1	Inverter board version	Year (Decimal)	Month (Hexadecimal)	Day (Two digits)	Day (One digit)	-
long -1 and 2	EPROM version	Year (Decimal)	Month (Hexadecimal)	Day (Two digits)	Day (One digit)	-

5. Setting of the key function.

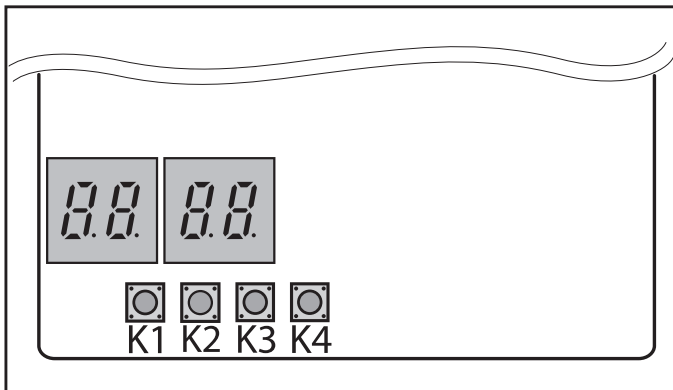

To set the option, refer to paragraph “Setting the option” on page 44.



11.2 UE HYDRO HP8-12 TESTING OPERATIONS.

1. Check the supply voltage between the outdoor unit and the auxiliary switch.

- Single-phase power supply: L, N

2. Check that the power and communication cables have been connected properly. (If the power and communication cables are mixed or connected improperly, the PCB will be damaged).

3. Press K1 or K2 on the outdoor unit board to execute the test mode and to interrupt (for the operating conditions of the indoor unit, see the relative booklet).

KEY	Function of BUTTONS	7-segment display	
K1	Press once: Operating test in central heating	"F" "7"	"BLANK" "BLANK"
	Press twice: Operating test in defrosting	"F" "3"	"BLANK" "BLANK"
	Press 3 times: End the test mode		-
K2	Press once: Cooling operating test	"F" "2"	"BLANK" "BLANK"
	Press twice: Signal emission operating test	"F" "4"	"BLANK" "BLANK"
	Press 3 times: End the test mode		-
K3	Resetting		-
K4	View mode	Refer to view mode	

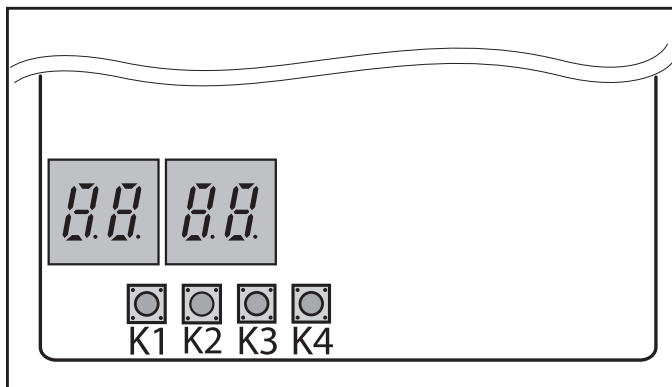
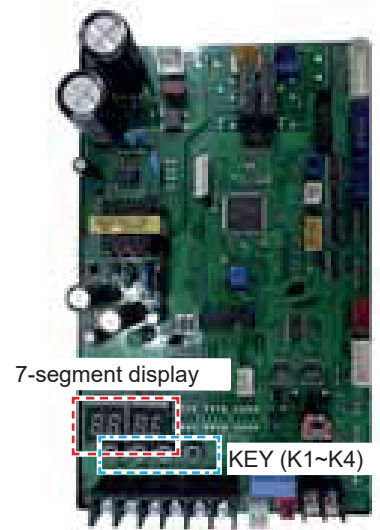

4. View mode: Press K4 to view information on the system status (K4 may not be used in Test stage).

To set the option, refer to paragraph "Setting the option" on page 44.



Number of times pressed	Contents viewed	Display				Unit
		Segment 1	Segment 2	Segment 3	Segment 4	
0	Communication status	Digit of Tx tens	Digit of Tx units	Digit of Rx tens	Digit of Rx units	-
1	Requested frequency	1	Digit of hundreds	Digit of tens	Digit of units	Hz
2	Current frequency	2	Digit of hundreds	Digit of tens	Digit of units	Hz
3	-	3	Digit of hundreds	Digit of tens	Digit of units	%
4	Outdoor air temp.	4	+/-	Digit of tens	Digit of units	°C
5	Compress. drain temp.	5	Digit of hundreds	Digit of tens	Digit of units	°C
6	Liquid phase sensor	6	+/-	Digit of tens	Digit of units	°C
7	Indoor unit return temp	7	+/-	Digit of tens	Digit of units	°C
8	Indoor unit flow temp.	8	+/-	Digit of tens	Digit of units	°C
9	Battery temp.	9	+/-	Digit of tens	Digit of units	°C
10	Inverter current	A	Digit of tens	Digit of units	First decimal	A
11	Fan RPM	B	Digit of thousands	Digit of hundreds	Digit of tens	rpm
12	Drain temperature target	C	Digit of hundreds	Digit of tens	Digit of units	°C
13	EEV	D	Digit of thousands	Digit of hundreds	Digit of tens	phase
14	Protection control	E	0: Cooling 1: Central heating	Protection control 0: No protection control 1: Freezing 2: Defrosting 3: Overload 4: Drain 5: Overall current	Frequency status 0: Normal 1: Pending 2: Low 3: High_limit 4: Low_limit	-
15	Inverter temp.	F	+/-	Digit of tens		°C
long-1	Main board version	Year (Decimal)	Month (Hexadecimal)	Day (Two digits)	Day (One digit)	-
long-1 and 1	Inverter board version	Year (Decimal)	Month (Hexadecimal)	Day (Two digits)	Day (One digit)	-
long-1 and 2	EPROM version	Year (Decimal)	Month (Hexadecimal)	Day (Two digits)	Day (One digit)	-

5. Set the key functions

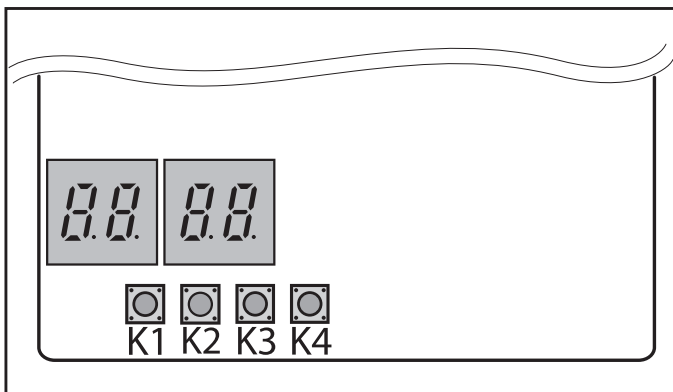

To set the option, refer to paragraph “Setting the option” on page 44.



Setting of the option.

1. Press and hold K2 to enter the option setting. (Only available when the operation is interrupted)

- If the option setting is entered, the display appears as follows.

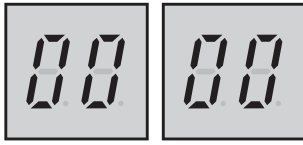

- Seg1 and Seg2 will show the number of the selected option.

- Seg3 and Seg4 will show the number of the set value of the selected option.

2. If the option setting has been entered, you may briefly press the switch K1 to adjust the value of Seg1, Seg2 and to select the desired option.

(Example)

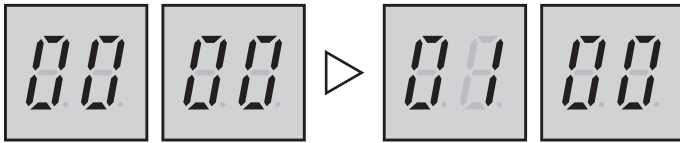

3. If you selected the desired option, you may briefly press the switch K2 to adjust the value of Seg3, Seg4 and to modify the function of the desired option.

(Example)

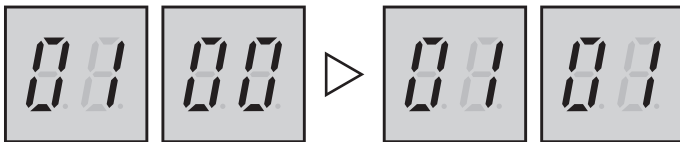

4. After having selected the function of the options, press and hold the switch K2 for 2 seconds. The modified value of the option will be saved when whole segments flash and mode monitoring begins.

ATTENTION:



- The modified option will not be saved if you do not finish setting the option as explained above.

- While setting the option, you may press and hold the key K1 to reset the previously set value.

- If you want to restore the default settings, press and hold the key K4 while setting the options.

- Holding down the key K4 restores the default settings, though it does not save them. Press and hold the key K2. When the segments show that monitoring mode is in progress, the setting will be saved.

Option	Inlet unit	SEG1	SEG2	SEG3	SEG4	Option function
Channel address	Main	0	0	A 0	U 0	Automatic address setting (default) Manual address setting (from 0 to 15)
Basic heater	Main	0	1	0 0	0 1	Activated (default) Deactivated
Operation mode	Main	0	2	0 0	0 1	Heat pump (default) Heating only
Snow accumulation prevention check	Main	0	3	0 0	0 1	Deactivated (default setting) Activated
Silent mode	Main	0	4	0 0 0 0 0	0 1 2 3 4	Manual silent mode (-3 dB) Manual silent mode * 09 (-5 dB) Manual silent mode * 0.75 (-7 dB) Manual silent mode (-3 dB) Low noise silent mode (default)
Energy saving mode	Main	0	5	0 0	0 1	Deactivated (default setting) Activated
Defrost - enter temperature difference	Main	0	6	0 0 0 0	0 1 2 3	Enter defrost temperature = Default Enter defrost temperature = Default+1°C Enter defrost temperature = Default+2°C Enter defrost temperature = Default+3°C

12 MAINTENANCE.

The checks and inspections listed must be implemented regularly, so that the unit can operate as intended at the production site.

Always turn off the unit and unplug it from the power supply source before carrying out any repairs or maintenance.

The operations mentioned must be carried out by qualified personnel at least once a year.

Glycol

- Record and check the concentration of glycol and the pH value in the system at least once a year.
- A lower pH value than 8.0 indicates that the inhibitor is running out and must be topped up.
- When the pH value is lower than 7.0 then glycol oxidation has occurred; the system must be drained and washed thoroughly to prevent severe damage.
- Make sure that glycol solution is disposed of in accordance with relevant local and national regulations.

12.1 ADDING REFRIGERANT.

The heat pump is supplied to users with a basic amount of refrigerants, as per initial setting values. While using the unit or doing work on the refrigerant pipes, refrigerant may leak, thus reducing the initial amount. To properly operate the units, keep the amount of refrigerant recommended by Immergas unchanged.

Refer to the following procedures to add the refrigerant amount.

ATTENTION:

- R-32 is added as a liquid phase.
- Use the Charging ports for additions and charging

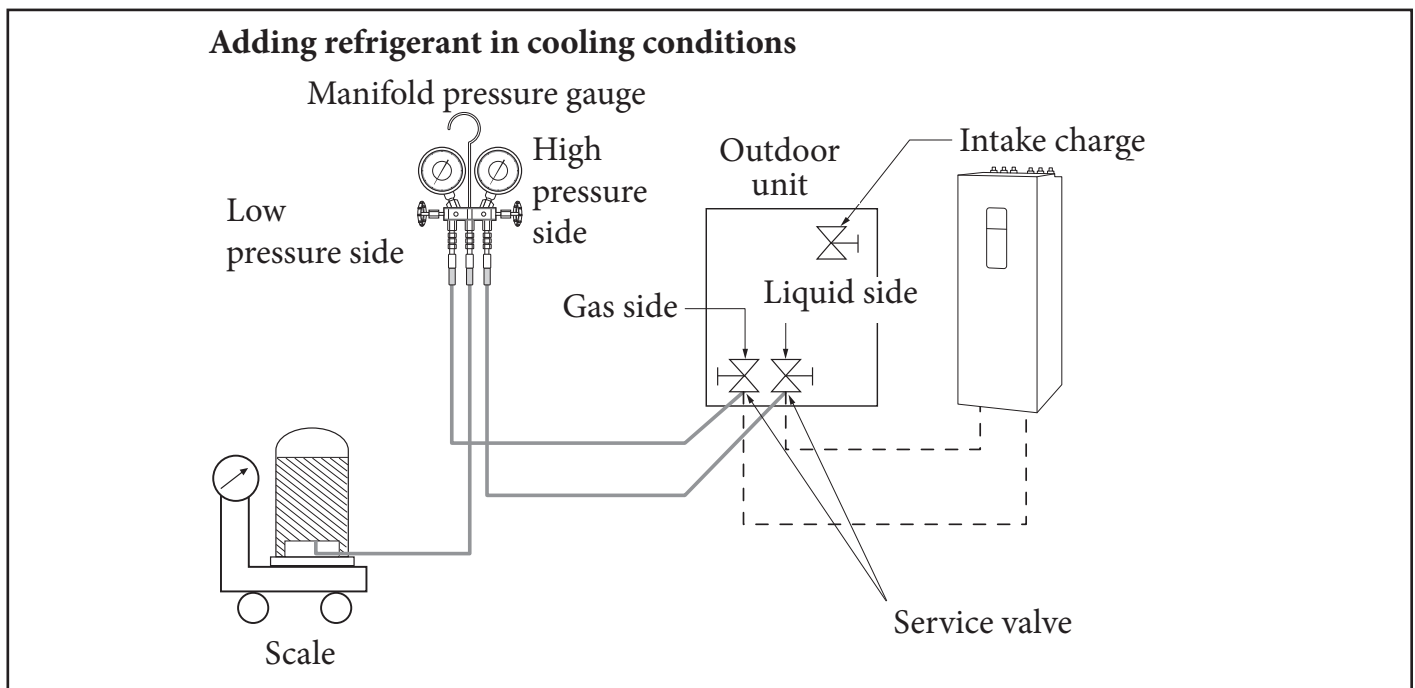

- Connect the pressure gauge to the manifold and bleed the manifold.
- Open the manifold pressure gauge valve of the liquid side service valve and add refrigerant liquid.
- If it is not possible to completely recharge the additional refrigerant, while the outdoor unit is stopped, use the key on the PCB of the outdoor unit to recharge the remaining refrigerant.
- Adding refrigerant in cooling
 - 1) Press the function key to add refrigerant in cooling mode.
 - 2) Open the valve on the gas side after 20 minutes of operation.
 - 3) Open the valve on the low-pressure side of the manifold pressure gauge to recharge the remaining refrigerant.

ATTENTION:



- **Open the gas side and liquid side service valve completely after charging the refrigerant. (If it is used with the service valve closed, important parts could be damaged).**

ATTENTION:



- **For products which use refrigerant R-32, avoid generating sparks by following the instructions below:**
- **Do not remove the fuses while the unit is on.**
- **Do not unplug the unit while it is on.**
- **It is recommended to install the outlet high up. Lay the cables in such a way that they do not get tangled**

12.2 PRECAUTIONS ON ADDING REFRIGERANT R-32.

In addition to the standard charging procedure, the following requirements must be met.

- Make sure there is no contamination by other refrigerants for charging.
- To minimise the amount of refrigerant, keep the flexible hoses and lines as short as possible.
- The cylinders must be upright.
- Make sure that the chilling system is earthed before charging.
- Label the system after charging, if necessary.
- Pay the utmost attention not to overcharge the system.
- Before charging, the pressure must be checked by blowing nitrogen.
- After charging, check for any leaks before activation.
- Make sure that you check for leaks before leaving the work area.

13 CHARGING THE REFRIGERANT.

Measure the amount of refrigerant based on the liquid side pipe length. Using a scale is recommendable to put in the required amount of coolant.

13.1 IMPORTANT INFORMATION: USED REFRIGERANT REGULATION.

This appliance contains fluorinated greenhouse gases. Do not release gases into the atmosphere.

ATTENTION:



Inform the user if the system contains 5 tCO₂e or more of fluorinated greenhouse gases. In this case, it will be necessary to check for any leaks at least once every 12 months, in accordance with Regulation No. 517/2014. This job must be carried out by qualified personnel only. In the situation considered above, the installer (or authorised person in charge of the final control) must draft a maintenance booklet containing all of the information prescribed in REGULATION (EU) No. 517/2014 OF THE EUROPEAN PARLIAMENT AND OF THE COUNCIL of 16 April 2014 on fluorinated greenhouse gases.

The following data must be specified in indelible ink both on the plate supplied with the appliance, relating to the refrigerant charge, and in this manual.

- ① Amount of refrigerant charged into the product at the factory.
- ② Amount of additional refrigerant charged on-site.

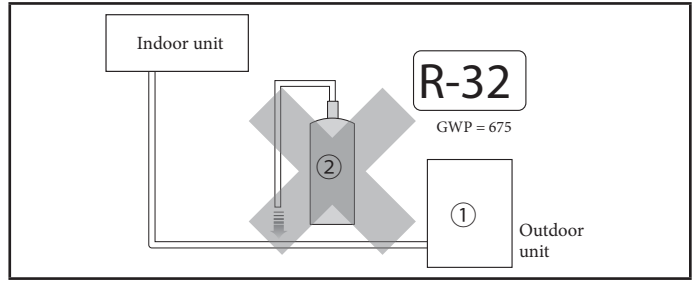

Unit	kg	tCO ₂ e
①, a		
②, b	DO NOT CHARGE	

Type of refrigerant	GWP value
R-32	675

- GWP: Global warming potential
- Calculation of equivalent tonnes of CO₂: kg x GWP/1000

- a) Amount of refrigerant charged into the product at the factory: see the unit rating plate 
- b) Amount of additional refrigerant added on-site. (See the information above for the amount of refrigerant added).

ATTENTION:

The filled-out label must be applied near the charging port. (for example, inside the cover of the shut-off valve.)



14 COMPLETING INSTALLATION.

- Check the following after having completed the installation.

Installation	Outdoor unit	<ul style="list-style-type: none"> - Check the external surface and the inside of the outdoor unit. - Is a short-circuit possible? - Is the position well ventilated and is there clearance space for assistance? - Is the outdoor unit firmly fixed?
	Indoor unit	<ul style="list-style-type: none"> - Check the external surface and the inside of the indoor unit. - Is the position well ventilated and is there clearance space for assistance? - Check whether the centre of the indoor unit is fixed and if it is installed horizontally
Installation of drain pipe		<ul style="list-style-type: none"> - Check the drain pipe of the outdoor unit and of the indoor unit. - Was the drain test completed? - Is the drain pipe suitably insulated?
Perform the wiring		<ul style="list-style-type: none"> - Was the outdoor unit earthed 3? - Is a 2-wire cable used? - Is the length of the wire within the limited range? - Is the wiring path correct?

15 FINAL INSPECTIONS AND TEST OPERATION.

15.1 INSPECTION PRIOR TO TEST OPERATION.

1. Check the power cable and the communication cable of the indoor unit and outdoor unit.
2. Check the supply voltage between the outdoor unit and the electric panel.
 - Check the voltage at 220-240 V ac ~ using a voltmeter.
3. Once the outdoor unit has been switched on, perform monitoring to verify that the indoor unit is connected and check the options.

15.2 TEST OPERATION.

1. **Run the unit by means of the indoor unit.**
 - Check the sound of the compressor during initial operation. Stop it if it makes a screeching noise.
2. **Check the operating status of the indoor and outdoor units**
 - Anomalous operating noise of the indoor and outdoor unit.
 - Correct drainage of the indoor unit in cooling mode.
3. **End of the test.**
4. **Explain to the customer how to use the condensing unit following the user manual.**

UE HYDRO HP12

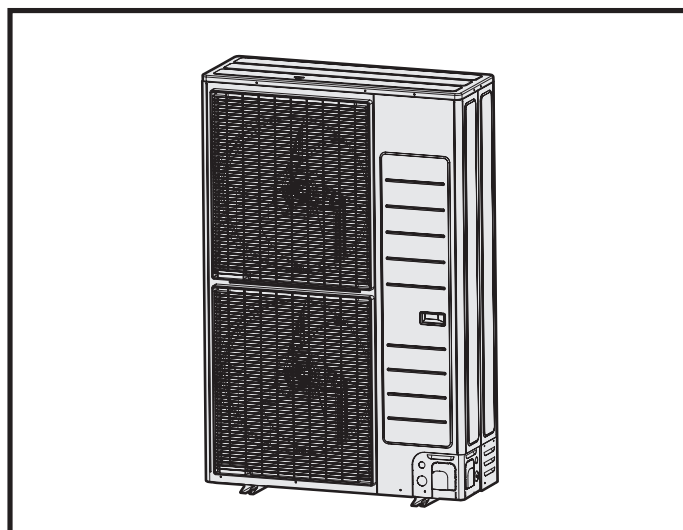

UE HYDRO HP5

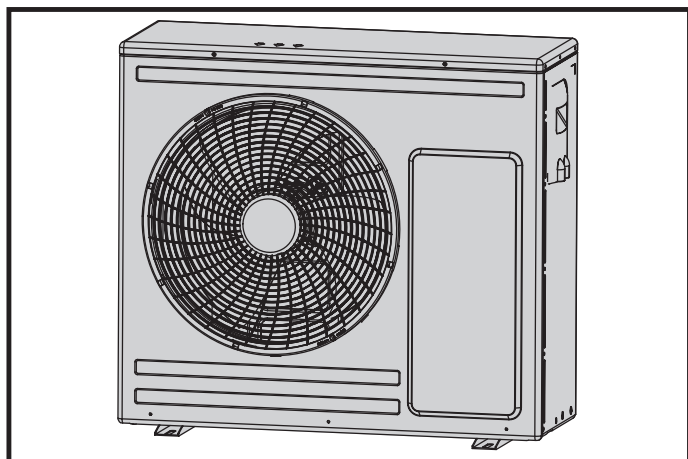

UE HYDRO HP8

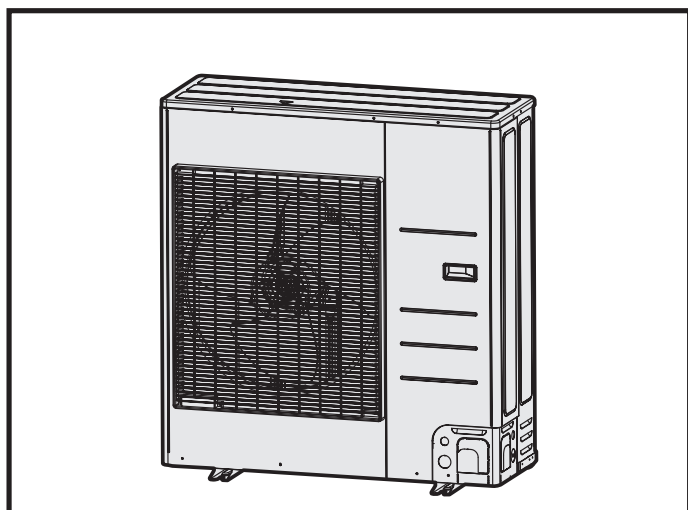



This instruction booklet
is made of ecological paper



immergas.com

Immergas S.p.A.
42041 Brescello (RE) - Italy
Tel. 0522.689011
Fax 0522.680617

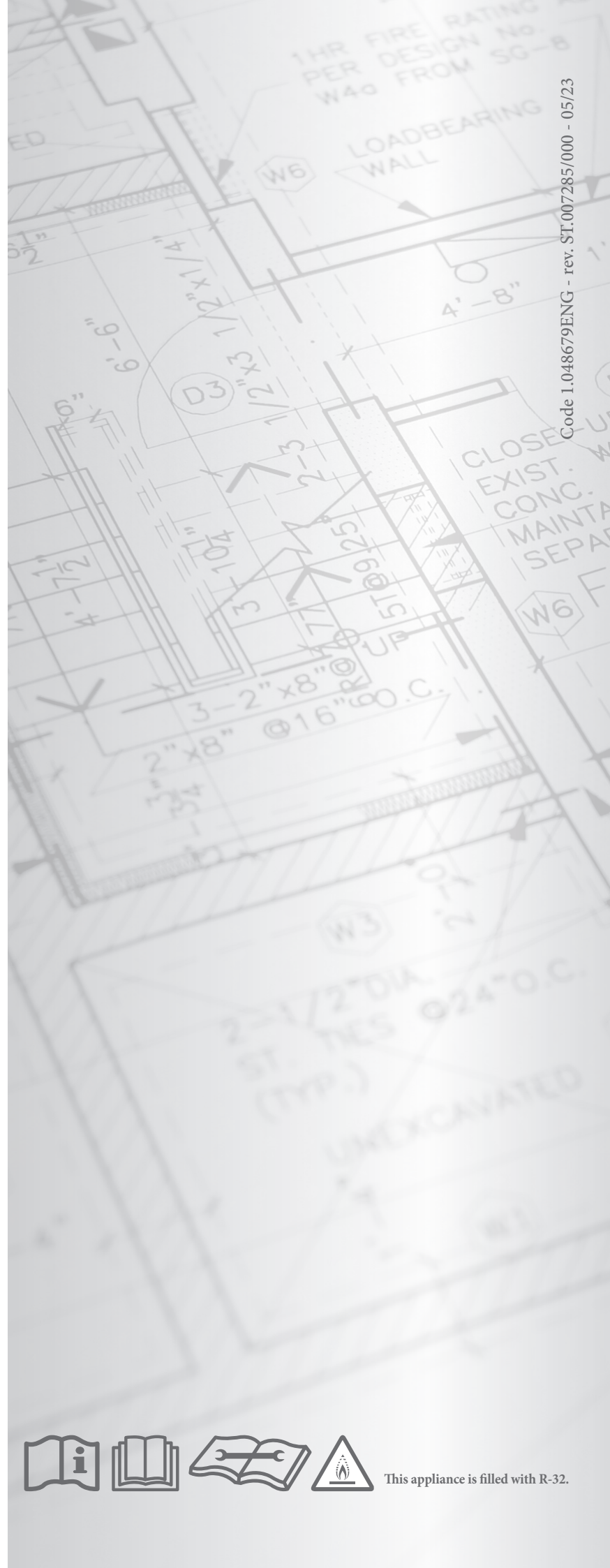

Code I.048679ENG - rev. ST.007285/000 - 05/23



This appliance is filled with R-32.