

PLEASE RESPECT YOUR ENVIRONMENT!  
Take care to dispose of this product and any packaging or literature in an appropriate way



### WHAT IS A PROGRAMMER?

...an Explanation for Householders (as recommended by the Energy Savings Trust)

Programmers allow you to set 'On' and 'Off' time periods. Some models switch the central heating and domestic hot water on and off at the same time, while others allow the domestic hot water and heating to come on and go off at different times. Set the 'On' and 'Off' time periods to suit your own lifestyle. On some programmers you must also set whether you want the heating and hot water to run continuously, run under the chosen 'On' and 'Off' heating periods, or be permanently off. The time on the programmer must be correct. Some types have to be adjusted in spring and autumn at the changes between Greenwich Mean Time and British Summer Time. You may be able to temporarily adjust the heating programme, for example, 'Override', 'Advance', or 'Boost'. These are explained in the manufacturer's instructions. The heating will not work if the room thermostat has switched the heating off. And, if you have a hot-water cylinder, the water heating will not work if the cylinder thermostat detects that the hot water has reached the correct temperature.



### WHAT IS A CYLINDER THERMOSTAT?

...an explanation for Householders (as recommended by the Energy Savings Trust)

A cylinder thermostat switches on and off the heat supply from the boiler to the hot water cylinder. It works by sensing the temperature of the water inside the cylinder, switching on the water heating when the temperature falls below the thermostat setting, and switching it off once this set temperature has been reached.

Turning a cylinder thermostat to a higher setting will not make the water heat up any faster. How quickly the water heats up depends on the design of the heating system, for example, the size of boiler and the heat exchanger inside the cylinder.

The water heating will not work if a time-switch or programmer has switched it off. And the cylinder thermostat will not always switch the boiler off, because the boiler sometimes needs to heat the radiators.

Cylinder thermostats are usually fitted between one quarter and one third of the way up the cylinder. The cylinder thermostat will have a temperature scale marked on it, and it should be set at between 60C and 65C, then left to do its job. This temperature is high enough to kill off harmful bacteria in the water, but raising the temperature of the stored hot water any higher will result in wasted energy and increase the risk of scalding.



## User Guide

### Y9120W Sundial RF<sup>2</sup> Pack 4

How to use:



ST9120C Wireless Enabled Timer  
CS92A Wireless Cylinder Thermostat

**This document is to be left with the user  
and forms part of a Home Information Pack**

**Honeywell**

## System Components

This section is to be completed by the Installer

		Location
ST9120C		
CS92A		(typically next to hot water cylinder, in bedroom)

## Energy Efficiency and the Environment

Home energy use is responsible for more than ¼ of the total UK carbon emissions which contribute to climate change. Heating and hot water systems based on boilers account for ¾ of this figure, so it is important to understand how your controls can help to maximize energy efficiency while maintaining your comfort.

Your Timer should be used in conjunction with appropriate temperature controls. In order to save energy the following general points should be observed:

1. Ensure your system contains a room thermostat (where appropriate) and a hot water thermostat, and that it is set to an appropriate temperature level, typically 20°C
2. Programme your heating (and hot water) to be off when you are not in the house. If you are concerned about possible frost damage to any exposed pipe work, it is advisable to fit a frost protection system – your installer can advise you about this.
3. Think about how you use your domestic hot water – if you have a storage system, it is not necessary to have this switched on all the time, even when you are in the house.
4. Consider the heat up times required for your central heating. Every home responds differently when the heating is switched on. Adjust the start time so that you are not cold when you get up in the morning. A shorter heat up time is required for other heating periods.
5. In the evening, when the house is up to temperature, it is often possible to switch off the heating up to an hour before you go to bed, without any noticeable reduction in comfort.

### Honeywell Control Systems Ltd.

Arlington Business Park,  
Bracknell  
Berkshire  
RG12 1EB

Technical Help Desk: 08457 678999  
www.honeywelluk.com

50047645-002 A

© 2011 Honeywell International Inc.

**Honeywell**

## ST9120C CONTROLS LAYOUT

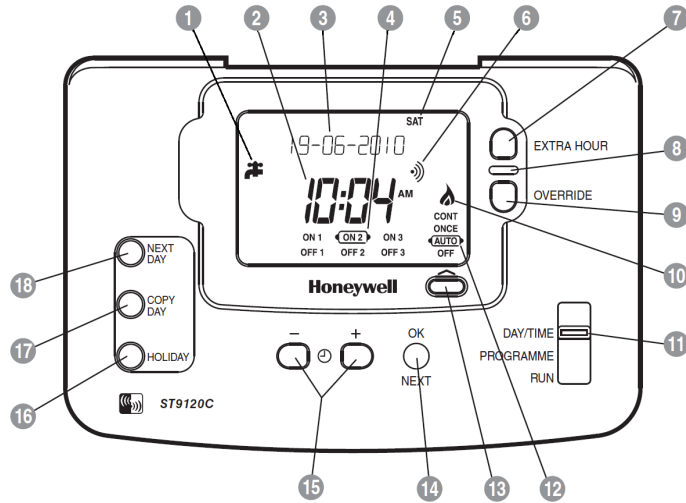

- ① 'ON' period indicator
- ② Time Display
- ③ LoT™ Technology Display
- ④ Programme Time Markers
- ⑤ Day of Week Indicator
- ⑥ RF Symbol
- ⑦ Extra Hour Button
- ⑧ Indicator Lamp
- ⑨ Override Button
- ⑩ Boiler Status Indicator
- ⑪ Slider
- ⑫ Operating Mode Indicator
- ⑬ Operating Mode Button
- ⑭ OK/Next Button
- ⑮ Clock - and + Buttons
- ⑯ Holiday Button
- ⑰ Copy Day Button
- ⑱ Next Day Button

## CS92A CONTROLS LAYOUT

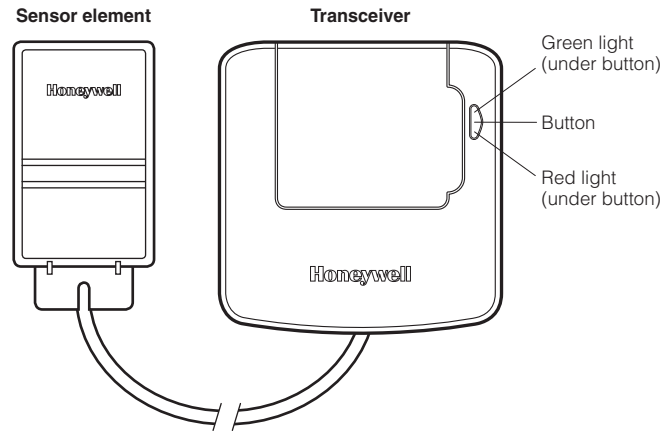

## CONFIGURATION & SERVICE DATA

### Boiler & System Service Log

The space below can be used to provide a record of boiler & system services and the names and contact numbers of the Installer and Service Personnel.

This information is important for a Home Information Pack.

Service/Installation Date	Installation/Service Engineer	Telephone Number / Contact Details

This product and its associated documentation and packaging are protected by various intellectual property rights belonging to Honeywell Inc. and its subsidiaries and existing under the laws of the UK and other countries. These intellectual and property rights may include patent applications, registered designs, unregistered designs, registered trade marks, unregistered trade marks and copyrights.

Honeywell reserves the right to modify this document, product and functionality without notice. This document replaces any previously issued instructions and is only applicable to the product(s) described.

This product has been designed for applications as described within this document. For use outside of the scope as described herein, refer to Honeywell for guidance. Honeywell cannot be held responsible for misapplication of the product(s) described within this document.

Manufactured for and on behalf of the Environmental and Combustion Controls Division of Honeywell Technologies Sàrl, ACS-ECC EMEA, Z.A. La Pièce 16, 1180 Rolle, Switzerland by its Authorised Representative Honeywell Inc.

# Contents

## CONTROL OF YOUR SYSTEM

General Description of Controls in Your System.....	4
The way to use a Timer.....	4
Your Cylinder Thermostat .....	5

## GETTING STARTED WITH YOUR ST9120C

Step 1: Setting the Date & Time .....	6
Step 2: Running a Built-in Programme .....	7

## PROGRAMMING YOUR ST9120C

The Built-in Programmes / Your Personal Programme.....	8
Reviewing the Programme Times .....	9
Modifying the Programme .....	9
Disabling / Enabling Time Periods .....	11

## OPERATING YOUR ST9120C

Choosing the Operating Mode .....	12
Overriding the Operation Without Changing the Programmes.....	12
The Extra Hour Function .....	13
The Holiday Function .....	13
Enquiry Mode .....	14

## FINE TUNING YOUR ST9120C

Changing from AM/PM Time Display to the 24 Hour Clock.....	15
Changing the Installer Parameters.....	15

## BOILER SERVICE REMINDER

Countdown to Service / When Service is Due .....	18
Shut-down.....	19

## OPERATING YOUR CS92A HOT WATER THERMOSTAT

Basic Operation .....	19
Battery Replacement .....	19
Error Indications .....	20

## FAQ AND TROUBLESHOOTING

Frequently Asked Questions .....	21
Troubleshooting Guide .....	23

## CONFIGURATION & SERVICE DATA (to be completed by Installer) .....

26

### General Description of Controls in Your System

Your Honeywell ST9120C provides timing control for your hot water system, letting you set **ON** and **OFF** periods to suit your own lifestyle.

The ST9120C does not directly control the temperature but works together with a CS92A wireless cylinder thermostat.

With 7-day programming and up to 3 on/off periods per day, every day can be set differently.

**ST9120C also has a Boiler Service reminder / Shut-down feature, which helps ensure your gas boiler is regularly serviced in compliance with UK Gas Safety Regulations. For more details see pages 18 & 19.**

Your system includes a CS92A wireless cylinder thermostat and may include other Honeywell wireless controls. These products use state of the art 2 way RF communications to share information and give you robust and flexible control of your indoor environment.

The following instructions explain how to programme and use the ST9120C, and associated controls, to provide the most home comfort at the least cost.

---

### The way to use a Timer

Think about the time periods when you are typically in the house and when you are not. These are the times you should use as the basis for the programmes. It will be necessary to allow some heat up time for the heating system after periods when it has been off – this would typically be 1 - 1½ hours, depending on your house and your preferences.

Other features are commonly available on the *Timer* to enhance comfort and convenience, for example, **OVERRIDE**, **EXTRA HOUR**, and **MODE** buttons.

A typical use of the **OVERRIDE** feature is when you return home unexpectedly for the rest of the day and the hot water is off. Just press the **OVERRIDE** button and the hot water will come on until the next programme time, at which point it will follow the normal programme. The advantage here is that you do not have to remember to switch off because the normal time programme does this for you.

A typical use of the **EXTRA HOUR** button would be if you returned to the house for a short period when the hot water was off. Pressing the **EXTRA HOUR** button gives you 1, 2, or 3 hours of hot water, exactly when you need it. Another typical use is when the hot water is already on and you want it to stay on a little longer - just press **EXTRA HOUR** and, for that day only, an hour will be added to the end of the time at which hot water normally goes off.

The **MODE** button allows you to select how you want to operate your hot water. A typical use of this feature would be if you take a mid-week day off work, you can then set the **MODE** to **ONCE** to keep the system **ON** during the day from the first programmed **ON** time till the last programmed **OFF** time.

---

### Your Cylinder Thermostat

Your CS92A wireless cylinder thermostat measures the water temperature and signals this to the ST9120C timer. The timer then performs all the necessary control actions to maintain the water temperature at the set value. The set temperature is programmed by your Installer in the ST9120C Installer Mode, and you should never need to change this. A value of 60°C is typical.

---

## GETTING STARTED WITH YOUR ST9120C

Your ST9120C should have been set up to work correctly when it was installed. However, the following will show you how you can modify your settings to meet your particular lifestyle.

To assist you with programming and everyday use your ST9120C will display text messages at every stage to help you get the most out of your central heating system. The ST9120C uses LoT™ Technology to constantly update the display to give you feedback about what is required.

### Step 1: Setting the Date & Time

Your ST9120C had the date and time set at the factory, and these are normally maintained by a backup battery in the event of power failures. If you wish to change the date or time, or if the LoT™ Display shows the message 'SET DATE + TIME' just follow the instructions below. Otherwise, go to **Step 2**.

- a. Move the slider to the **DAY/TIME** position. The message 'SET DATE + TIME' will show briefly on the screen, followed by 'SET THE DAY', and the day of the month will now be flashing to indicate it can be changed.

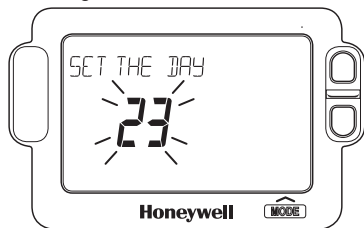

- b. To change the day of the month, press the  $\ominus$   $\omin�$  or  $\oplus$  buttons until the correct day is shown. Each press of the button will change the date by one day. As soon as a change has been made, the message 'IS DAY OK?' will be displayed. Once the correct day is reached, press the green  $\text{OK}$  button to confirm, and move to the next step. If you do not need to make a change, just press the  $\text{OK}$  button immediately and this will move you to the next step.
- c. The month digits will now be flashing and 'SET THE MONTH' will be displayed. To change the month, press the  $\ominus$   $\omin�$  or  $\oplus$  buttons until the correct month is shown. The message 'IS MONTH OK?' will be displayed. Press the green  $\text{OK}$  button to confirm the month is correct and move to the next step.
- d. The year digits will now be flashing and 'SET THE YEAR' will be displayed. To change the year, press the  $\ominus$   $\omin�$  or  $\oplus$  buttons until the correct year is shown. The message 'IS YEAR OK?' will be displayed. Press the green  $\text{OK}$  button to confirm the year is correct. If you have made a change and the date is a valid date, the message 'DATE SAVED' will show and you can move to the next step. If the date you set was not valid, for example 31 September, the message 'INVALID' will show and you will be returned to the start of the date setting operation.
- e. The time will now be flashing and the message 'SET THE TIME' will be displayed. To change the time, press the  $\ominus$   $\omin�$  or  $\oplus$  buttons until the correct time is shown. Each press of the button will change the time by one minute. Holding the button down for more than a few seconds will change the time slowly at first, then quickly. The message 'IS TIME OK?' will be displayed. Press the green  $\text{OK}$  button to confirm the time is correct. If you have made a change, the message 'TIME SAVED' will show, followed quickly by 'DATE + TIME COMPLETE'.
- f. Move the slider to the **RUN** position to complete setting the date and time.

**Note:** if the slider is moved at any time before the date and time have been set correctly, the message 'DATE UNCHANGED' will be displayed briefly, and your changes will not be saved.

---

## Step 2: Running a Built-in Programme

With the date and time correct, your ST9120C Timer will now be operating to the built-in programmes. These have been designed to provide hot water at typical times throughout the day, but if you want to customise the settings, please see the next section '**PROGRAMMING YOUR ST9120C**' (page 8).

## The Built-in Programmes

The built-in programmes give you a starting point that you can personalise to your own requirements. Your Installer should have selected one and ticked the box alongside it. If there is no tick, the product normally leaves the factory with Profile A installed, but it is a simple matter to select one of the other profiles (see **Changing the Installer Parameters**, page 15).

Built-in Programme (Profile A)

	ON 1	OFF 1	ON 2	OFF 2	ON 3	OFF 3
<b>Monday to Friday</b>	6:30am	8:30am	12:00pm	1:00pm	4:30pm	10:30pm
<b>Saturday &amp; Sunday</b>	6:30am	9:30am	12:00pm	1:00pm	4:30pm	11:00pm

Built-in Programme (Profile b)

	ON 1	OFF 1	ON 2	OFF 2	ON 3	OFF 3
<b>Monday to Friday</b>	6:30am	9:30am	12:00pm	1:00pm	4:30pm	11:00pm
<b>Saturday &amp; Sunday</b>	6:30am	9:30am	12:00pm	1:00pm	4:30pm	11:00pm

Built-in Programme (Profile C)

	ON 1	OFF 1	ON 2	OFF 2	ON 3	OFF 3
<b>Monday to Friday</b>	6:30am	7:30am	12:00pm	12:00pm	5:00pm	10:00pm
<b>Saturday &amp; Sunday</b>	8:30am	9:30am	12:00pm	1:00pm	5:30pm	10:30pm

## Your Personal Programme

The table below has been left blank for you to record your own personal programme.

	ON 1	OFF 1	ON 2	OFF 2	ON 3	OFF 3
<b>Monday</b>						
<b>Tuesday</b>						
<b>Wednesday</b>						
<b>Thursday</b>						
<b>Friday</b>						
<b>Saturday</b>						
<b>Sunday</b>						



## Reviewing the Programme Times

To review your programme, move the slider to the **PROGRAMME** position.

To review the programme times, press the **OK** button repeatedly. The appropriate **ON** and **OFF** markers will be displayed to show you which time is being reviewed. Any of these times can be adjusted by using the **⏪** **⏩** or **+** buttons, and then confirmed using the **OK** button. Remember to return the slider to the **RUN** position after reviewing is complete.

## Modifying the Programme

The programme has three pairs of **ON/OFF** switching times per day. Each time can be set between 3.00 am and 2.50 am (on the next day) to allow you to programme to stay on past midnight, if required.

- Move the slider to the **PROGRAMME** position. 'SET PROGRAMME' will show briefly to verify this action.

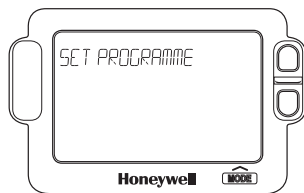

- 'SET ON-TIME 1' will then be displayed and the time setting for the first **ON 1** time for **MONDAY** will now be flashing to indicate it can be changed. If you do not wish to change the time, press the green **OK** button and move to the next step. If you do wish to make a change, use the **⏪** **⏩** or **+** buttons to change the first **ON 1** time. Each press of the button will change the time by 10 minutes. As soon as the time has been changed, the message 'ON-TIME 1 OK?' will be displayed. Press the green **OK** button to confirm the time is correct and move to the next step. 'SAVED' will be displayed for a moment to confirm that any change has been saved to memory.

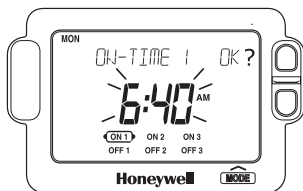
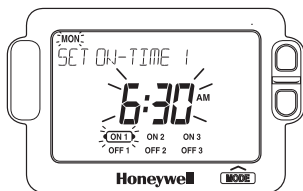

## PROGRAMMING YOUR ST9120C

**Note:** When pressing the (+) button the next **ON** or **OFF** marker may start to flash. This indicates you have tried to set a time equal to one of the next programme times already in the memory. Similarly, when pressing the (-) button the previous **ON** or **OFF** marker may start to flash. This indicates you have tried to set a time equal to one of the previous programme times. If this happens the ST9120C simply moves both times together as long as you continue to press the (-) (+) or (+) (-) buttons. Follow the procedure in '**Reviewing the Programme Times**' (page 9) to check and adjust these times as necessary.

- c. 'SET OFF-TIME 1' will be displayed and the first **OFF 1** time will now be flashing. If you do not wish to change the time, press the green (OK) button and move to the next step. Otherwise, use the (-) (+) or (+) (-) buttons to change the time. Press the green (OK) button to confirm the time is correct and move to the next step. 'SAVED' will be displayed for a moment to confirm that any change has been saved to memory.
- d. The remaining **ON** and **OFF** times (ON 2, OFF 2, ON 3, OFF 3) can be set by using the (-) (+) or (+) (-) buttons to change the time, then the green (OK) button to confirm the time is correct and move to the next step. If you do not wish to change the time, just press the green (OK) button to move directly to the next **ON/OFF** time without making any changes.
- e. After setting or reviewing the last off time, **OFF 3**, the message 'COMPLETE' will be displayed to indicate the times for Monday have been set.

You now have a choice of how to set the programme for the next day:

### Copying One Day's Programme to Another Day (example Monday to Tuesday):

- f. Whilst the day is showing Monday, Press the **COPY DAY** button. The message 'COPY MON TO TUESDAY OK?' will be displayed and the letters **TUE** will flash to indicate the programme for Monday can be copied to Tuesday.
- g. To select a different day to copy to, press the **NEXT DAY** button to cycle through the days. With each press of the **NEXT DAY** button the message will change to indicate the new day you are copying to.
- h. When the required day is indicated, press the green (OK) button to confirm, and the message 'MON COPIED' will be displayed for a moment. The day into which Mondays programme has been copied is now available to have its programme edited.

**Note:** Once a day's programme has been confirmed in this way, it now becomes the day whose programme is copied if the **COPY DAY** button is pressed again.

OR

### Programming a Different Day:

- i. Press the **NEXT DAY** button to select the next day, which is displayed along the top of the screen. The programme for that day can then be adjusted by following steps **b** – **e** above. Programmes for the remaining days can be set in the same way, using the **NEXT DAY** button to move to the next day.

**Exiting Programming Mode:**

To exit programming mode, move the slider to the **RUN** position. This can be done at any time during the programming process, and any changes made and confirmed with the **OK** button will have been saved.

**Note:** If the unit is left in Programming mode for more than 10 minutes without the slider being moved or any buttons pressed, the message 'MOVE SLIDER' will be displayed. Press a button to finish programming, or move the slider to the **RUN** position.

---

**Disabling / Enabling Time Periods**

To disable any of the time periods **ON 1** to **OFF 1**, **ON 2** to **OFF 2**, or **ON 3** to **OFF 3**, simply set the **ON** time and its paired **OFF** time to the same time, and the programme will just ignore them.

To re-enable the time period, simply set the two **ON** and **OFF** times to be different.

### Choosing the Operating Mode

The operating mode may only be changed when the slider is set to the **RUN** position.

The  symbol is displayed during a programmed on period. A green **INDICATOR LAMP** shows when the system is switched **ON**.

A **MODE** button is provided to select the Operating Mode and therefore how the system is controlled.

There are four possible **Operating Modes**; these are **OFF**, **AUTO**, **ONCE**, **CONT**. Pressing the **MODE** button scrolls round these modes in sequence, and the display indicates which mode is currently active.

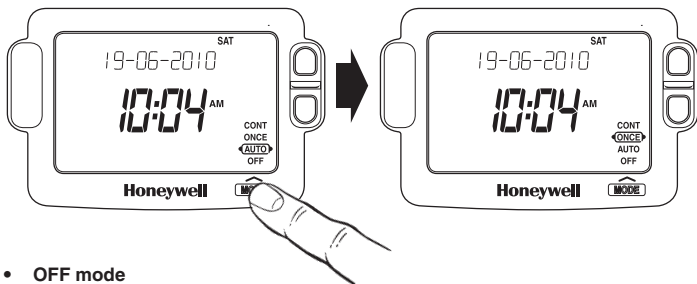

- **OFF mode**  
The system will remain **OFF**.
- **AUTO (Automatic) mode**  
The system will be switched **ON** and **OFF** according to the programme.
- **ONCE mode**  
The system will come **ON** at the first programmed **ON** time, and go **OFF** at the last programmed **OFF** time.
- **CONT (Continuous) mode**  
The system will remain **ON** continuously.

### Overriding the Operation Without Changing the Programmes

In **AUTO** and **ONCE** operating modes, the **OVERRIDE** button switches the hot water **ON** or **OFF** without altering the programme.

When the  symbol is displayed, pressing the **OVERRIDE** button switches the system **OFF** until the next programmed **ON** time.

If the  symbol is not displayed, pressing the **OVERRIDE** button switches the system **ON** until the next programmed **OFF** time.

The LoT™ Display will provide you with information about the override.

## The Extra Hour Function

The **EXTRA HOUR** button allows you to switch the system **ON** for up to 3 extra hours without altering the programme. Pressing the button once will give one extra hour. The *LoT™ Display* will display the message '+ 1 HOUR', to confirm the button has been pressed.

When the system is **OFF** (the  symbol is not displayed), pressing the **EXTRA HOUR** button switches the system **ON** for just one hour.

When the system is **ON** (the  symbol is displayed), pressing the **EXTRA HOUR** button extends the programmed **ON** period by one hour.

Further presses of the **EXTRA HOUR** button will increase the extra hour period by one hour for each button press, up to a maximum of 3 hours. The *LoT™ Display* will continue to provide information on the extra hour status.



To cancel the extra hours, just keep pressing the **EXTRA HOUR** button until the 'CANCELLED' message appears on the *LoT™ Display*.

---

## The Holiday Function

The Holiday function allows you to switch off your system for a specified number of days (from 1-99 days). This lets you save energy and related costs when you are away from home, but resumes normal operation on the day of your return.

### To set the Holiday function:

- Ensure the slider is in the **RUN** position, then press the **HOLIDAY** button once. The message 'SET HOLIDAY' will appear briefly, followed by 'SET DAYS AWAY'.
- Use the  or  buttons to set the number of days you will be away. The display will show the number of days, and this number will be flashing to indicate it can be changed. The day of the week will also keep changing to show the day you return.
- If you have made a change to the number of days, the message 'DAYS AWAY OK ?' will appear. Press the green  button to confirm your selection.
- The message 'SAVED' will be displayed for a few seconds, followed by the date you return, to enable you to check you have programmed the holiday function correctly.
- During the holiday period, the *LoT™ Display* will show the message 'ON HOLIDAY' and the display will count down the number of days till you return.

### To cancel the Holiday function:

- To cancel the Holiday function, just press the **HOLIDAY** button again. The *LoT™ Display* will show 'CANCELLED' and the unit will return to normal operation.

**Note:** while setting the Holiday function, if there is a gap of more than 1 minute between button presses, the function will cancel itself automatically and return to normal operation.

### Enquiry Mode

As the heart of your system, the ST9120C has access to temperature information from the other system components, and allows you to enquire about this information.

**To enter Enquiry Mode, ensure the slider is in the RUN position, then press and hold the **OK** button for 4 seconds.**

The *LoT™ Display* will show the message 'INFO MENU' to confirm that you have entered Enquiry Mode.

Pressing the **◀** **⊖** or **⊕** **▶** buttons then allows you to step around and view the available information. The *LoT™ Display* will continue to update to tell you what information is being viewed, and the main display will show the value. If the information is not available, the display will show dashes --- instead of a temperature value. The table below shows the type and sequence of information available in Enquiry Mode.

#### To exit Enquiry Mode:

If the **OK** button is not pressed for 30 seconds, your ST9120C will return to **RUN** mode.



Information	LoT™ Message	Other display symbols
* Room temperature	ROOM TEMP	▣▣▣▣
* Room temperature setting	ROOM SET	▣▣▣▣
‡ Hot water temperature	WATER TEMP	‡
‡ Hot water temperature setting	WATER SET	‡

\* This information will be available if you have a room temperature control system, with a DT92E room thermostat.

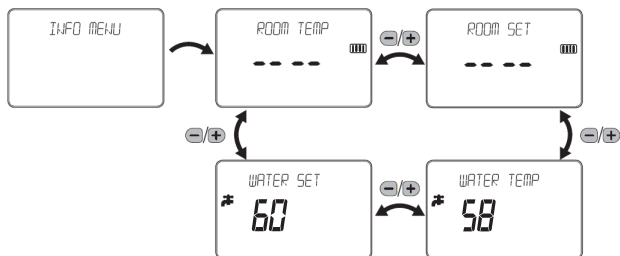
‡ This information will be available if you have a hot water control system, with a CS92A hot water sensor



## Changing from AM/PM Time Display to the 24 Hour Clock

Your ST9120C can operate on the 12 hour AM/PM or 24 hour clock formats. To change the format, ensure the slider is in the **RUN** position then press and hold the  and  buttons together for about 2 seconds. Ignore the 'NOT VALID' message that will appear briefly. Then the displayed times will be changed automatically to the new format.

Repeating this procedure will change the clock display back to the original format.

## Changing the Installer Parameters

The ST9120C has a special Installer Mode where some features can be adjusted to suit your lifestyle or preferences – these are called Installer Parameters, and are listed in the table below, along with a description of the options that are possible.

Your installer should set this up for you to suit your application (see CONFIGURATION & SERVICE DATA section). However, you may wish to alter some of the settings yourself, and this section shows you how to do this.

**Note:** some parameters indicated by \* are not used used if your system is only controlling the hot water.

INSTALLER PARAMETER	Parameter Number	Default Value	Options	Description
24hr or am/pm clock display.	1	12	12, 24	12 = am/pm display 24 = 24hr display
Configure backlight operation.	2	2	0, 1, 2	0 = off 1 = on if button pressed 2 = on continuously
Enable/disable auto time change.	3	1	0, 1	0 = disabled 1 = enabled
1-day or 5/2-day or 7-day operation.	4	7	1, 5, 7	1 = 1-day operation 5 = 5/2-day operation 7 = 7-day operation
Number of ON/OFFs per day.	5	3	2, 3	2 = 2 on/off's per day 3 = 3 on/off's per day
Select default time programme.	6	A	A, b, C	A = standard b = at home C = economy
Set hot water temperature	8	60°C	40 to 85°C	Stored hot water set temperature

## FINE TUNING YOUR ST9120C

INSTALLER PARAMETER	Parameter Number	Default Value	Options	Description
* Optimum start	9	0	0, 1, 2	0 = no optimum start 1 = delayed start 2 = optimum start on
* Optimum start limit	10	1	1, 2, 3	1 = 1 hour 2 = 2 hours 3 = 3 hours
* Optimum stop	11	0	0, 1	0 = disabled 1 = enabled
* Frost protection temperature	12	5	5 to 16°C	Frost protection temperature
* Minimum ON/OFF time	13	1	1, 2, 3, 4, 5 mins	Minimum ON/OFF time in minutes
* Cycle rate	14	6	3, 6, 9, 12	Number of boiler cycles per hour
* Proportional band width	15	1.5	1.5 to 3.0°C	Width of control proportional band in °C
Failsafe mode (loss of RF communications)	16	0	0, 1	0 = off 1 = heating on 20%
Reset all parameters	20	1	0, 1	0 = do not reset 1 = default parameters

### To Enter Installer Mode:

- Ensure the slider is in the **RUN** position, then press and hold **OK** and **⊖** buttons together for 8 seconds. Ignore the 'NOT VALID' message that is displayed for a few seconds. The message 'SET UP MENU' will show briefly, followed by 'SET INSTALLER OK ?'
- Press the **OK** button to take you into the Installer Mode Parameter Menu.
- Parameter 1 is now available to change. This is to allow you to change the clock format from 12 hour AM/PM to 24 hour. At every step, the *LoT™ Display* will inform you what the parameter means and what option you have selected. The parameter number is shown on the display separated by a colon from the parameter value.
- You can change the parameter value by pressing the **⊖** or **⊕** buttons. At this point the description in the *LoT™ Display* will change and the parameter value will flash. If you press **OK** the value will stop flashing and be saved for use.



- e. Press **OK** to move to the next parameter available for editing.
- f. Keep pressing **OK** to step around the list of parameters, and use **↓** **←** or **+** buttons to change the parameter value.
- g. Any parameter changes that have been confirmed with the **OK** button will be saved and used.

**To Exit Installer Mode:**

- h. You can exit Installer Mode at any time by moving the slider to the next position and then back again to **RUN**.

**Note:** Installer Mode will exit automatically after 10 minutes if the slider is not moved.

---

## BOILER SERVICE REMINDER

If your house is rented, by Law, your gas boiler should be inspected once a year to ensure it is operating safely. Your ST9120C Timer has a range of features designed to help make sure this service is carried out at the correct time. These features will be programmed by your Installer, Maintenance Engineer, or Landlord.

- If it has been set to do so, ST9120C will display a message on the screen to remind you that a boiler service is due.
- If the service is overdue, the Timer may switch off the heating system, to ensure your safety. If this happens you must arrange an immediate service visit. Contact details should be listed on page 26 of this guide, in the section Boiler & System Service Log.
- A contact telephone number may also have been programmed into the ST9120C. If so, a message will appear on the *LoT™ Display* indicating the number you should call.

---

### Countdown to Service

Your ST9120C can indicate a countdown for the number of days until your service is due. This message will appear on the screen every few seconds, to give you an opportunity to schedule a service visit.



---

### When Service is Due

When your boiler service is **OVERDUE** the words "**SERVICE DUE**" will continue to flash on your screen, and you should arrange an immediate service visit.

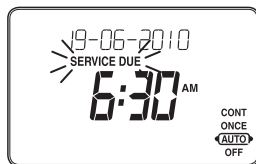

## BOILER SERVICE REMINDER

### Shut-down

If your ST9120C shows the words “**SERVICE DUE**” and “**OFF**” then your boiler service is **overdue** and the boiler has been automatically switched off to ensure your safety – you should arrange an immediate service visit.

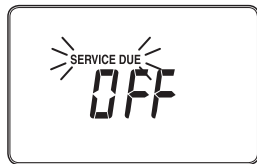

If set to do so, it may be possible to obtain limited use of the boiler by pressing the **EXTRA HOUR** button. Each button press will allow operation of the boiler for 1 hour at a time, and the screen will display the message “**On 1h**” as shown. However, you should still arrange an immediate service visit, as this will allow you to comply with the law and ensure your gas boiler is operating safely.

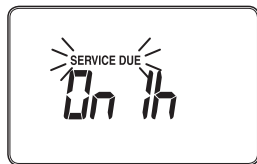

## OPERATING YOUR CS92A HOT WATER THERMOSTAT

### Basic Operation

Your CS92A consists of a sensor element that is strapped to the metal surface of the hot water cylinder and a wireless transceiver box that is normally mounted on a wall surface apart from the cylinder. The transceiver communicates with the ST9120C programmer and regularly sends the hot water temperature measurement to it.

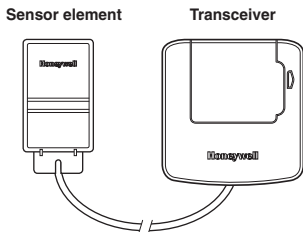

### Battery Replacement

The CS92A batteries should last for a minimum of 2 years. Well before they run out, CS92A will communicate with ST9120C and it will show the message 'SENSOR LOW BATT' whilst also flashing the tap symbol.

Batteries are accessed by unclipping the front cover at the bottom. Note battery polarity. Reverse process to refit front cover.

Use 2xLR6 (AA) alkaline batteries only.

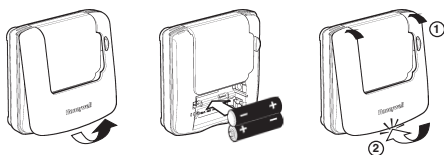

## Error Indications

To save battery power, CS92A will indicate error conditions on the LoT™ Display of ST9120C. It is possible to view the CS92A status by pressing the button on the transceiver box. The lights underneath this button will provide feedback as shown in the table. Go to the FAQ AND TROUBLESHOOTING section for more information.

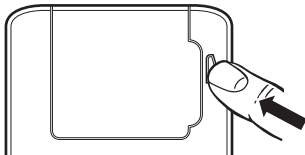

Green Light	Red Light	Status
On	Flashes up to 5 times in succession, then repeats	Everything is OK, red light shows signal strength - press button again to exit
Off	Flashes 0.1 s on, 0.9 s off	Battery low condition, replace batteries
Off	Flashes 0.5 s on, 0.5 s off	Sensor error, check sensor connection
Off	On continuously	Loss of communications

### How do I set the time only, if the ST9120C clock is not correct?

Your ST9120C contains an accurate digital clock that is factory set. Should you ever need to change the time, just follow this procedure:

- a. Move the slider to the **DAY/TIME** position.
- b. Keep pressing the green **OK** button until the message 'SET THE TIME' is displayed. To change the time, press the **⏪** or **⏩** buttons until the correct time is shown. The message 'IS TIME OK?' will be displayed. Press the green **OK** button to confirm the time is correct. If you have made a change, the message 'TIME SAVED' will show, followed quickly by 'DATE + TIME COMPLETE'.
- c. Move the slider to the **RUN** position, to complete changing the time.

---

### What do I do when the clocks go back in October and forward in March?

Your ST9120C is factory set to change the clock automatically at the correct dates, so you should never need to adjust the clock forward or backwards yourself. It is possible to disable this particular feature, as described in the section '**Changing the Installer Parameters**' (page 15). You may also check the section '**Configuration & Service Data**' (page 26) to see how your Installer has configured your product.

---

### What should I do if I get 'lost' while programming the ST9120C?

The *LoT™ Display* on ST9120C will provide you with help and tips to work through the programming. Should you ever get 'lost', the simplest thing to do is to move the slider to the **RUN** position, and then move it back to the appropriate programming position where you got lost. At this point just follow the instructions again.

---

### What happens if there is a power failure?

In the event of a mains power failure, the ST9120C display will go blank, the indicator lamps will go out, and the control outputs will switch off. The real time will be constantly maintained by means of the built-in battery backup, ready to power back up as if nothing had happened when the mains power is restored. In addition, all programmes and settings are stored in a special memory (called Non Volatile memory) which requires no power to maintain information so will be retained indefinitely.

Should the correct time and date ever be lost, for whatever reason, the message 'SET DATE + TIME' will be displayed whilst the slider is in the **RUN** position. In this case, simply follow the procedure described under '**Step 1: Setting the Date & Time**' (page 6). It should not be necessary to make any changes to your programmes.

## How reliable is 2-way RF communication?

The 2-way RF communication (also known as wireless communication) used by Honeywell is extremely robust and reliable. When installed correctly the Signal Strength test feature allows the Installer to locate the system components where mutual signal reception is strong. During communication, signals are sent several times to ensure receipt, and if any message is garbled, the error detection software recognises this and ensures the message is repeated again.

---

## What do I do if RF communication is lost?

Follow the steps in the Troubleshooting Guide on the next page. The most likely cause for loss of communications is the CS92A batteries running low on power. This will be indicated on CS92A, as described on page 19. Simply replace the batteries (as shown on page 19) and wait a few minutes for communications to become re-established.

If this does not resolve the problem it may be that the RF signal path between the ST9120C and the CS92A is blocked by a metal object. Check the direct path between the two devices and reposition any object that may be blocking the signal, or move the thermostat.

---



## How do I know when to change the batteries in the CS92A cylinder thermostat?

If the CS92A batteries need changing, ST9120C will show the message 'SENSOR LOW BATT' and the tap symbol  will flash. You can confirm this by pressing the CS92A button, whereupon the red light will give a brief flash every second to indicate a low battery state. It is important to change the CS92A batteries as soon as the low battery condition is indicated, as reduced battery power may affect the RF signal strength and impair RF communications.



---

## Troubleshooting Guide

This is a quick guide to help you diagnose and cope with possible problems with your wireless control system. For further assistance, please contact your Installer.

Symptom	Possible Cause	Remedy
ST9120C has a blank LCD display	No power to the heating system	Check that there is power to the heating system
	Fault in ST9120C	Call Installer
ST9120C indicates the system is <b>ON</b> , but taps are running with cold water.	Temperature controls are switched off or set too low	Check that the temperature controls in the system are set to appropriate levels
	Boiler or other system controls have malfunctioned	Call Installer
ST9120C shows the message: 'INTERNAL FAULT'	Fault in ST9120C	Call Installer
Every few seconds, the ST9120C screen shows the message: 	ST9120C is counting down the number of days until your next boiler service is due.	Arrange a boiler service before the counter reaches zero. After servicing your boiler, the Service Engineer / Installer will reset the ST9120C to remind you when the next boiler service is due. Each service is normally a maximum of 1 year apart.
Although the heating is still operating, the ST9120C screen keeps flashing the message: 	Your boiler service is <b>overdue</b> .	Arrange an immediate boiler service. After servicing your boiler, the Service Engineer / Installer will reset the ST9120C to remind you when the next boiler service is due. Each service is normally a maximum of 1 year apart.
The ST9120C screen shows the message: 	Your boiler service is <b>overdue</b> and the boiler has been automatically switched off to ensure your safety.	Arrange an immediate boiler service. If set to do so, it may be possible to obtain limited use of the boiler by pressing the <b>EXTRA HOUR</b> button. Each button press will allow operation of the boiler for 1 hour at a time, and the screen will display the message ' <b>On 1h</b> '. After servicing your boiler, the Service Engineer / Installer will reset the ST9120C to remind you when the next boiler service is due. Each service is normally a maximum of 1 year apart.

## Troubleshooting Guide (cont.)

Symptom	Possible Cause	Remedy
ST9120C shows the message 'SENSOR LOW BATT' and a flashing tap symbol 	CS92A batteries are running low on power	Change the CS92A batteries (see page 19 for how to do this)
CS92A battery low indication (press CS92A button and red light gives a short flash every second 0.1s on, 0.9s off. Note: light will switch off after approx 1 minute to save battery power)		
ST9120C shows the message 'NO SIGNAL' and a flashing tap symbol 	CS92A batteries are running low on power	Change the CS92A batteries (see page 19 for how to do this)
	RF communication path between ST9120C and CS92A is blocked, possibly by a metal object	Check direct path between both products and re-position any objects that may be blocking the signal  Relocate the CS92A transceiver, if possible
ST9120C shows the message 'SENSOR FAULT' and a flashing tap symbol   CS92A sensor error indication (Press CS92A button and red light blinks 0.5s on, 0.5s off. Note - light will switch off after approx 1 minute to save battery power)	CS92A sensor cable may be disconnected from the wiring terminals	Re-connect the sensor wires to the CS92A terminals
	Fault with CS92A	Call Installer





## CONFIGURATION & SERVICE DATA

### Application

Insert application number as per Installation wiring diagrams:

### Configuration Data (to be completed by Installer)

The tables below are for the Installer to complete to indicate how your ST9120C has been configured.

Configurable Features	Options	Factory setting	Installer configured (tick box or note value)
<b>ST9120C Configuration - standard</b>			
24hr or am/pm clock display.	am/pm display	✓	
	24hr display		
Display backlight operation.	Off		
	on if button pressed		
	on continuously	✓	
Automatic time change.	disabled,		
	enabled	✓	
1-day or 5/2-day or 7-day operation.	1-day operation		
	5/2-day operation		
	7-day operation	✓	
Number of ON/OFFs per day.	2 on/off per day,		
	3 on/off per day	✓	
Default time programme.	A = standard	✓	
	b = at home		
	C = economy		
Hot water set temperature	From 40 to 85°C	60°C	
Optimum start	no optimum start	✓	
	delayed start		
	optimum start on		
Optimum start limit	1 hour	✓	
	2 hours		
	3 hours		
Optimum stop	disabled	✓	
	enabled		
Frost protection temperature	From 5 to 16°C	5°C	
Minimum ON/OFF time	1, 2, 3, 4, 5 minutes	1 minute	
Cycle rate	3, 6, 9, 12 cycles per hour	6 cycles	
Proportional band width	From 1.5 to 3.0°C	1.5°C	
Failsafe mode (loss of RF communications)	off	✓	
	on 20% *		

\* This option will not operate on a hot water only system