

Y9420H Sundial RF² Pack 2 INSTALLATION INSTRUCTIONS



Application

This pack provides a wireless control solution for adding a wireless room thermostat to an existing Sundial system with wired cylinder thermostat.

Pack Contents & Product Descriptions

1 x ST9420C1008 Wireless enabled 7 day programmer with 2 output control relays for switching boilers, pumps and zone valves in heating systems. It requires permanent mains 230Vac power.

1 x DTS92E1020 Wireless digital room thermostat with energy saving ECO function. It operates on 2xAA alkaline batteries, giving a battery life of at least 2 years under typical operating conditions.

1 x table stand for DT92E (optional)

Other Honeywell products may be required for a complete installation. See Schematic System Layouts (below) or refer to www.honeywelluk.com for full details.



Sundial RF² is a registered trademark of Honeywell Inc.

50047644-007 A

System Operation

DT92E and ST9420C both use 2-way communication on an 868MHz radio frequency (RF) band to control the heating and stored hot water system.

ST9420C operates as the control hub of the system, and DT92E is free to be positioned anywhere in the living space.

This functionality is ideal for upgrading existing systems without a room thermostat to ensure compliance with Building Regulations. It is also ideal for new or refurbished systems, where running mains cable from the programmer to the thermostat and back to the boiler is difficult or impractical.

This document is to be left with the user

Schematic System Layouts

94-1 Wireless room thermostat, wired cylinder thermostat, wired valves, wired TPI boiler control

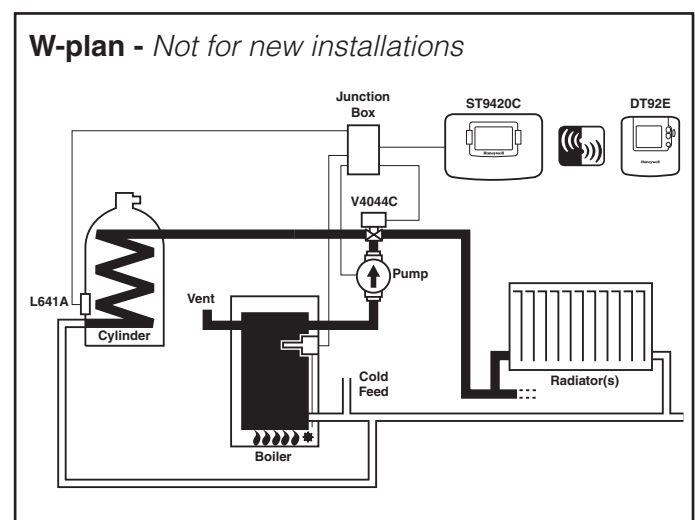
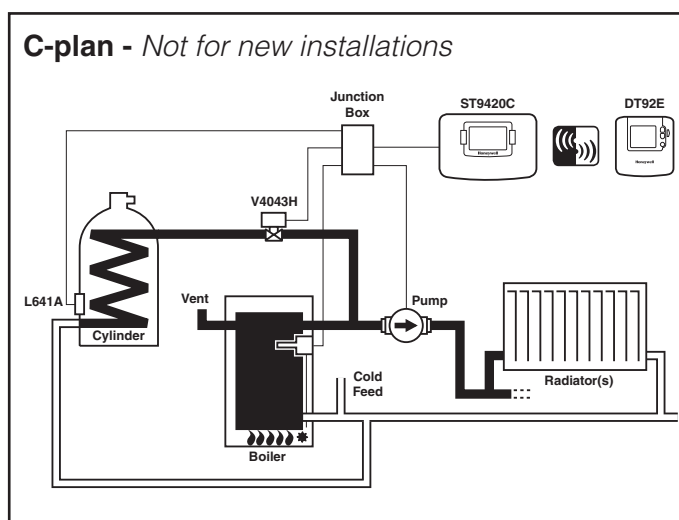
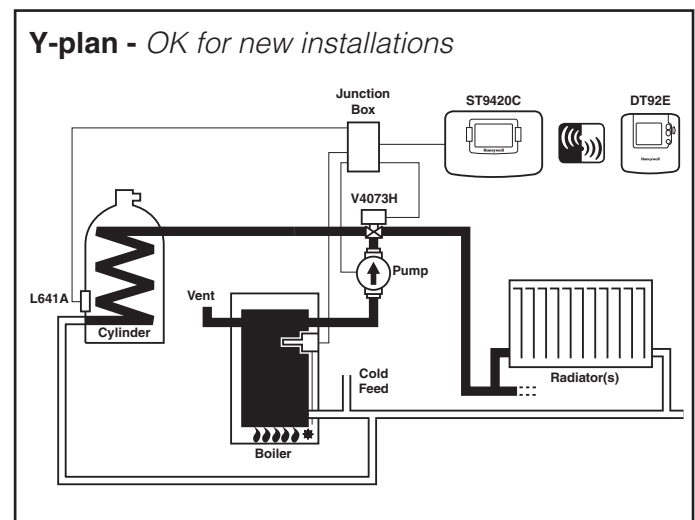
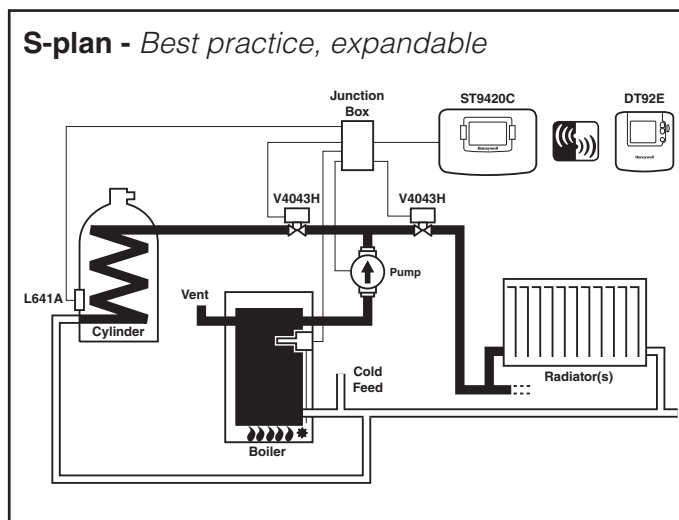

Installation Notes

The RF link between the Room Thermostat (DT92E) and the Programmer (ST9420C) in Honeywell system packs is pre-configured at the factory and therefore both units should be installed at the same site.

- If products from individual system packs are separated, or mixed with other pre-configured system packs during installation, or a faulty unit is being replaced, the desired units must be specially configured to allow them to communicate with each other. This process is called Binding. Please refer to section **5 Binding / Rebinding Procedure**.
- DT92E or ST9420C will not communicate with other RF products that use different frequencies or communications protocols.
- The DT92E room thermostat requires no power source other than the batteries provided.
- **The ST9420C Programmer requires a permanent 230V~ supply.**
- The Programmer should be installed and powered up before commencing the Room Thermostat installation.

RF Signal Propagation

Within a typical house the two products should communicate reliably within a 30m range. It is important to take into consideration that walls and ceilings will reduce the RF signal. The strength of the RF signal reaching the Programmer depends on the number of walls and ceilings separating it from the room thermostat, as well as the building construction - the diagram below illustrates an example of typical signal strength reduction. Walls and ceilings reinforced with steel or plasterboard walls lined with metal foil reduce the RF signal significantly more.

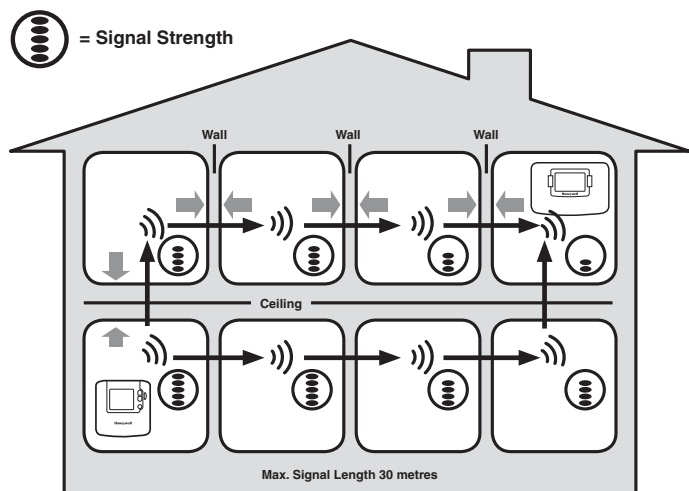

Typical example of Building Fabric Signal losses

Installation Sequence: Step by Step

Section	Page
1 INSTALLING THE ST9420C PROGRAMMER.....	3
1.1 Mounting ST9420C	3
1.2 Mounting options	3
1.3 Wiring ST9420C	3
1.4 Final Assembly.....	3
1.5 ST9420C Internal Wiring.....	4
1.6 Sundial Plan Wiring Diagrams (S, Y, C, W plans)	4
1.7 Replacement Wiring	5
1.8 Replacing Other Manufacturers' Time Controls	5
1.9 Powering Up ST9420C	5
2 INSTALLING THE DT92E ROOM THERMOSTAT	6
2.1 Locating DT92E	6
2.2 Powering Up DT92E	6
2.3 Signal Strength Test.....	6
2.4 Mounting DT92E	7
3 SYSTEM CONFIGURATION: ST9420C	8
3.1 ST9420C Installer Modes.....	8
3.2 Boiler Service Reminder / Shut-down Feature.....	8
3.3 Installer Setup	9
3.4 Installer Setup Flowchart	10
3.5 Set Service.....	10
3.6 Change PIN	12
3.7 What the User Will See When a Service is Due	12
3.8 Resetting the Service Timer Function	12
4 SYSTEM CONFIGURATION: DT92E	13
4.1 DT92E Installer Mode	13
5 BINDING / RE-BINDING PROCEDURE	14
5.1 Binding.....	14
5.2 ST9420C Guided Binding Menu.....	14
5.3 Binding Menu Display.....	14
5.4 Binding Menu Flowchart.....	15
5.5 How to Bind DT92E to ST9420C.....	15
6 COMMISSIONING THE SYSTEM	16
6.1 System Test Checklist.....	16
6.2 Completion Checklist.....	16

1 INSTALLING THE ST9420C PROGRAMMER

1.1 Mounting ST9420C

For best performance, install in an open space. Leave at least 30cm distance from any metal objects including pipes and the boiler housing.

If the ST9420C is replacing an existing ST9400 or ST6400 then the existing wall-plate and wiring may be used, subject to any required electrical checks.

If the existing wall-plate is mounted on a metal wall-box, the RF signal performance may be impaired. After locating the DT92E room thermostat, use the Signal Strength Test shown on Page 6 to determine if there is a reception problem. If problems persist, it is recommended that this metal wallbox is replaced by an equivalent plastic wallbox.

The Programmer should be mounted at a level where the display can be seen clearly, (compliance with Building Regulations part M requires a height of 1.2m from the floor) and the ambient temperature is within the range of 0 to 40°C. The ST9420C is for use in normal domestic environments.

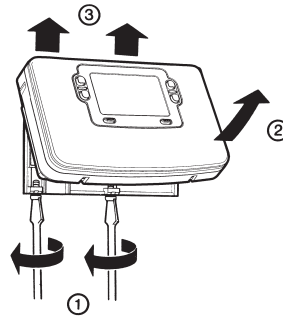

To remove the unit from the wall-plate, slacken the two securing screws at the bottom of ST9420C and hinge the unit up to separate the two halves.

CAUTION

Isolate power supply and make safe before wiring the unit to prevent electric shock and equipment damage. Installation should be carried out by a qualified electrician or competent heating engineer.

1.2 Mounting Options

Recommended clearance distances:

Above wallplate:	110mm
Below wallplate:	100mm
Left/right of wallplate:	10mm

Ensure the mounting surface is supporting and fully covers the wiring wall-plate.

a. Surface mounting concealed wiring

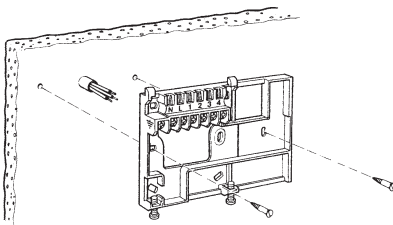

b. Flush switchbox

Fixing holes are spaced to suit BS4662 requirements

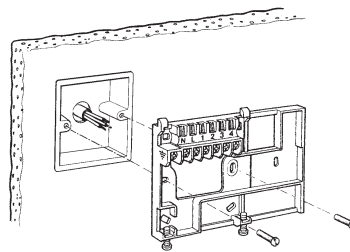

c. Surface mounting with surface wiring in mini trunking

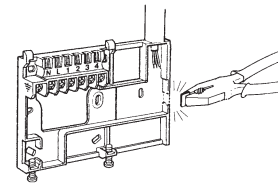

1.3 Wiring ST9420C

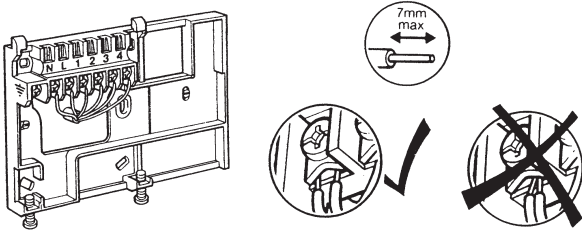

EMC compliance considerations

Keep AC mains supply/load cables separate from signal wiring.
Refer to Code of Practice standards EN61000-5-1 and -2 for guidance.

ALL WIRING MUST BE IN ACCORDANCE WITH IEE REGULATIONS. THIS UNIT IS FOR FIXED WIRING ONLY.

A switch, having contact separation of at least 3mm in all poles must be incorporated in the fixed wiring as a means of disconnecting the supply.

The unit is a Class II (double insulated) device. A parking terminal is provided for external earth continuity.

The system must be appropriately fused. A fuse rated at no more than 3 Amps should be installed.

The unit has 4 knockouts for surface wiring. Care must be taken to ensure that the cable or mini-trunking completely fills the knockout hole without leaving any gaps.

1.4 Final Assembly

Clip the unit onto the hinges on the top of the wallplate and hinge down into position. Tighten the two securing screws using a screwdriver.

Switch on the power – the unit will now be operating according to the built-in programme.

Note: the ST9420C is supplied with a factory set clock for faster installation.

Refer to Y9420H User Guide for programming details.

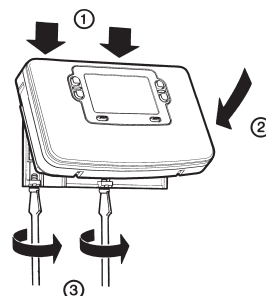

1.5 ST9420C Internal Wiring

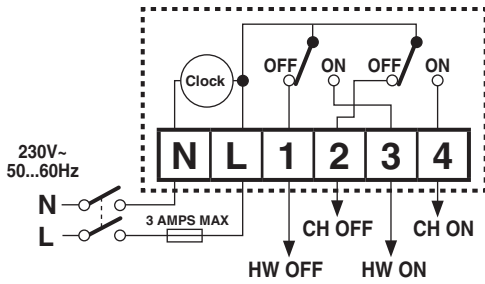

Notes

1. DT92E is completely wireless and so is not shown connected on these wiring diagrams.
2. The ST9420C is a Class II (double insulated) device. A parking terminal is provided for earth wiring continuity, if required.
3. In the Sundial S-Plan, W-Plan, and Y-Plan wiring diagrams, connections are shown to basic boilers only. For wiring connections to Pump over-run boilers refer to Boiler manufacturers' instructions or to Honeywell Technical Help Desk for assistance.
4. It is recommended that gravity circulation hot water systems are fitted with a suitable hot water control valve as shown in the Sundial C-Plan system.

1.6 Sundial Plan Wiring Diagrams

94-1 Wireless room thermostat, wired cylinder thermostat, wired valves, wired TPI boiler control

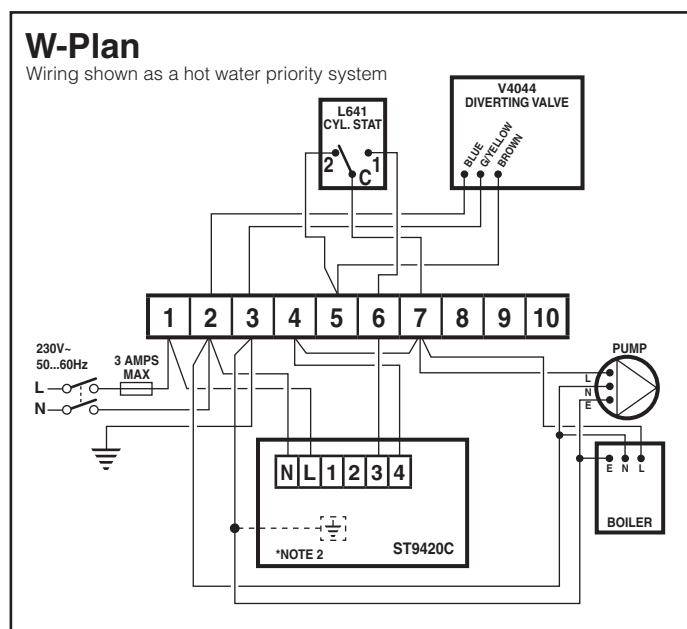
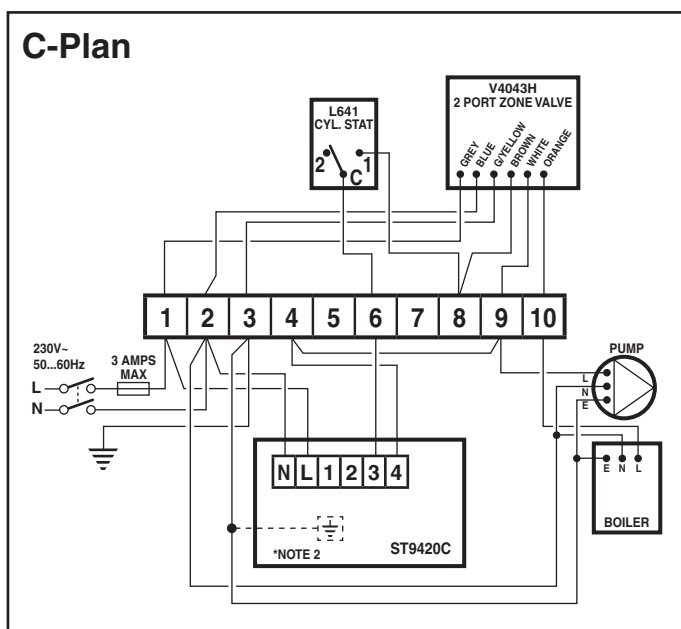
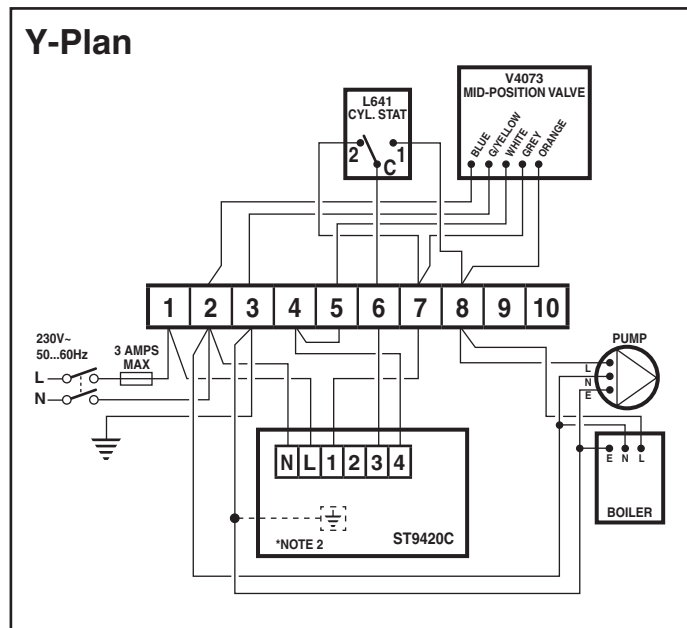
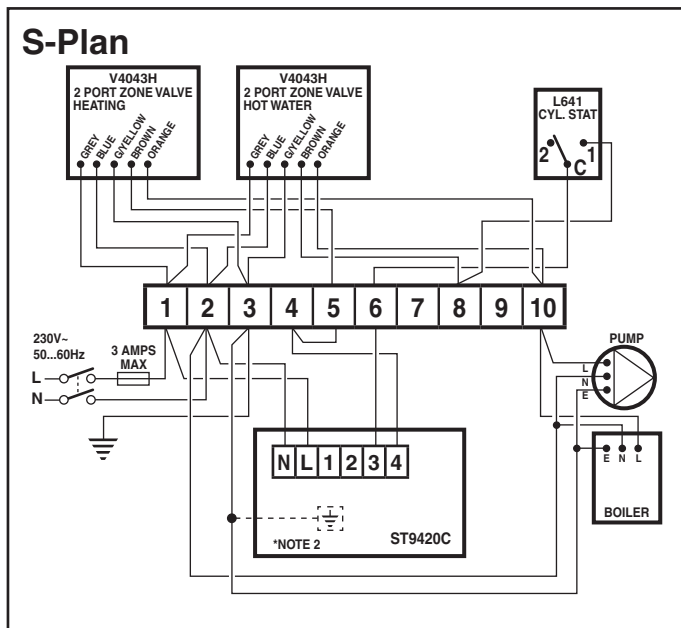

1.7 Replacement Wiring

If using ST9420C to replace other Honeywell Programmers, the equivalent wiring terminations are shown in the tables below.

ST6300/ST6400/ST9400	N	L	1	2	3	4		
ST9420C	N	L	1	2	3	4		

ST699/ST799	N	L	3	4	5	6	7	8
ST9420C	N	L	4	2	not connected	3	1	not connected

ST7100	N	L	3	4	5	6	7	8
ST9420C	N	L	not connected	2	4	not connected	1	3

When converting a fully wired system, remove the wired room thermostat and its associated electrical wiring. Some minor changes are required at the 10-way junction box. These are described in the table below and shown on the wiring diagrams on page 4.

	Remove links	Add links
S-Plan		Add wire link from terminal 4 to terminal 5
Y-Plan		Add wire link from terminal 4 to terminal 5
C-Plan	Remove wire link from terminal 5 to terminal 9	Add wire link from terminal 4 to terminal 9
W-Plan		Add wire link from terminal 4 to terminal 7

1.8 Replacing Other Manufacturers' Time Controls

ST9420C Programmers will mount directly onto many existing manufacturers' back-plates, with a minimal need for re-wiring. They are also supplied complete with a wiring back-plate, should this not be the case.

Refer to Honeywell Technical Help Desk for wiring conversion diagrams.

1.9 Powering Up ST9420C

Check the unit powers up correctly and that the display does not remain blank.

ST9420C must be powered up before DT92E is installed, so that the signal strength tests can be conducted.

The initial signal strength test will verify that both units have each others addresses in their memory, and can therefore communicate. The process of writing respective addresses into memory is called BINDING.

2 INSTALLING THE DT92E ROOM THERMOSTAT

2.1 Locating DT92E

For best performance, install DT92E in an open space where it can sense the room temperature, and where the signal strength is high.

The Room Thermostat can be mounted on a wall or on the optional table stand. Do not mount on metal wall-boxes.

Leave at least 30cm distance from any metal objects and at least 1 metre from any other electrical equipment.

Select the preferred location and test the Signal Strength before installation.

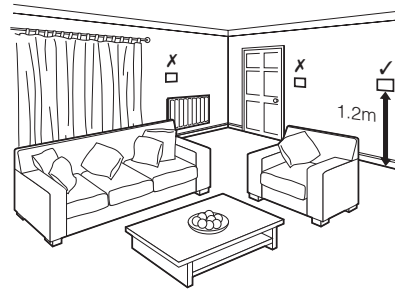

2.2 Powering Up DT92E

DT92E is supplied in the pack with the mounting plate separated from the rest of the unit for ease of installation. The next sequence of operations should be done before mounting DT92E onto its mounting plate.

First hold DT92E between 1 and 2 metres from ST9420C. To power it up, unclip the battery cover and then remove the paper tab that isolates the batteries from their contacts. When the display powers up the battery cover should be clipped back on.

Immediately on power up, DT92E will try to communicate and synchronise with ST9420C. This process may take up to 4 minutes, and will be indicated by the word **'Sync'** on the DT92E display.

When **'Sync'** disappears from the display, DT92E is ready for a test of the RF signal strength between it and the ST9420C programmer.

Now go to section 2.3 to conduct the **Signal Strength Test**.

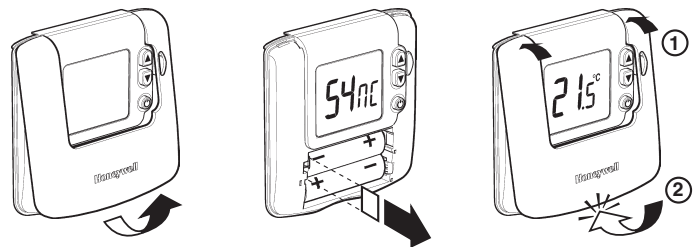

2.3 Signal Strength Test

Honeywell 2-way RF communications allows signal strength testing to ensure DT92E can be positioned in the best possible location.

To enter **Signal Strength Test**:

- Hold down the button for 2 seconds until the symbol is displayed.
- Hold down the and buttons together for 3 seconds until **'Inst'** appears in the display.
- Press the button (**'Cont'** is now displayed)
- Hold the button for 3 seconds to enter **Test** mode.
- Signal Strength Test** is entered from **Test** mode by holding the button for 3 seconds, until the display shows **'SS'**.

ST9420C measures the strength of the DT92E signal every 5-10 seconds and will communicate this to DT92E as a number between 0 and 5. The value drops to 0 briefly as each new signal strength measurement is made.

A signal strength of 3 or more is recommended to ensure reliable communications.

Step 1

Hold DT92E approximately 1 meter from ST9420C and check the signal strength is high (> 2). This confirms the two units are in the condition they left the factory and are bound together, and you can move to Step 2.

If the signal strength is shown as 0, the units are possibly not bound together. Go to the **section 5 Binding / Rebinding**, follow the procedure there, and then repeat the complete Signal Strength Test sequence.

Step 2

Whilst staying in Signal Strength Test mode, take the DT92E to the preferred location. Wait for 10 seconds and check the signal strength is 3 or more. If so, the DT92E is ready to mount.

If the signal strength is less than 3, re-position the room thermostat within the local area +/- 1 or 2m to see if the signal strength improves. If this fails, try to reduce the range/distance between the room thermostat and the ST9420C.

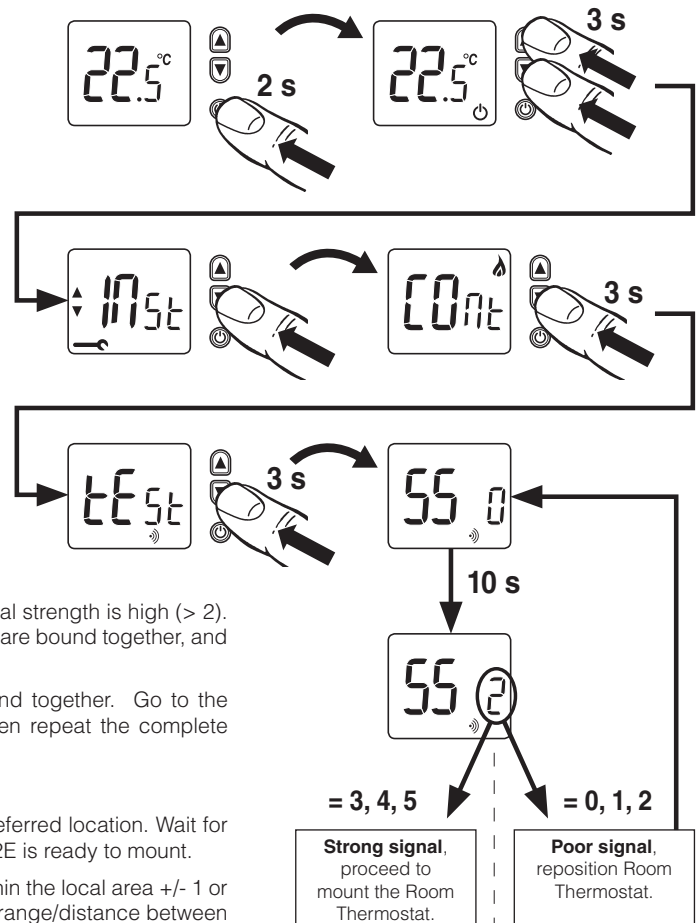

Exit Signal Strength Test by holding the button for 5 seconds. The DT92E will timeout of this mode after 10 minutes.

2.4 Mounting DT92E

DT92E can be mounted (a) directly on a wall, or (b) on the optional table stand provided.

Wall mounting is recommended as it ensures a position of high signal strength can be maintained.

- a. For wall mounting, install the mounting plate first, then follow steps 1, 2 and 3 to hinge the front piece on, as shown in the diagrams.

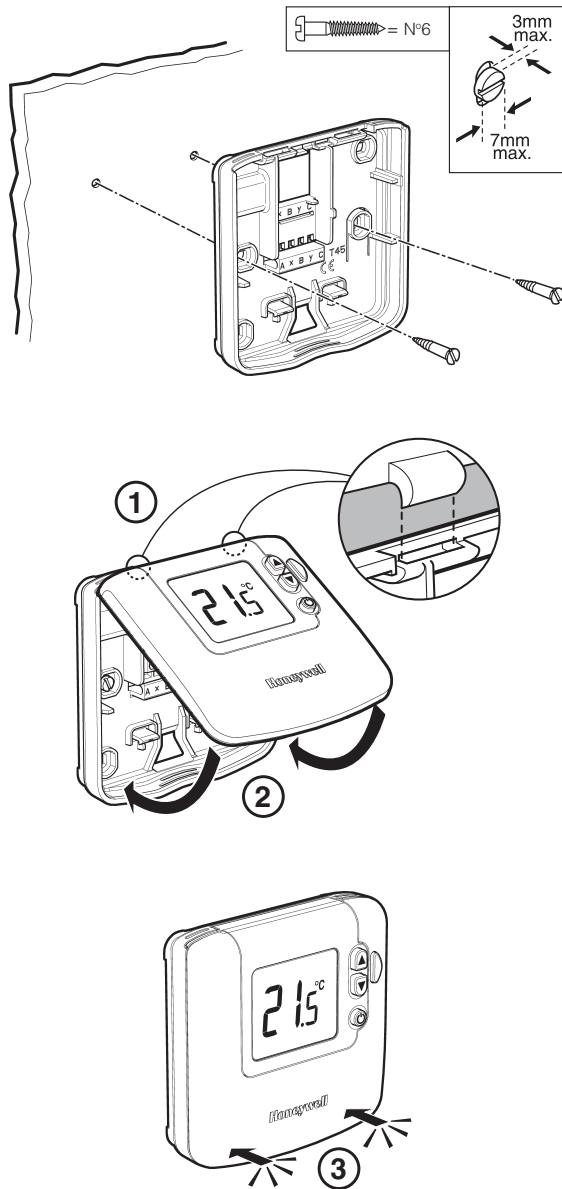

- b. If the optional table stand is to be used, first assemble the two pieces together as shown. Next follow steps 1, 2 and 3 to hinge the DT92E front piece onto its mounting plate, and mount the unit onto the table stand.

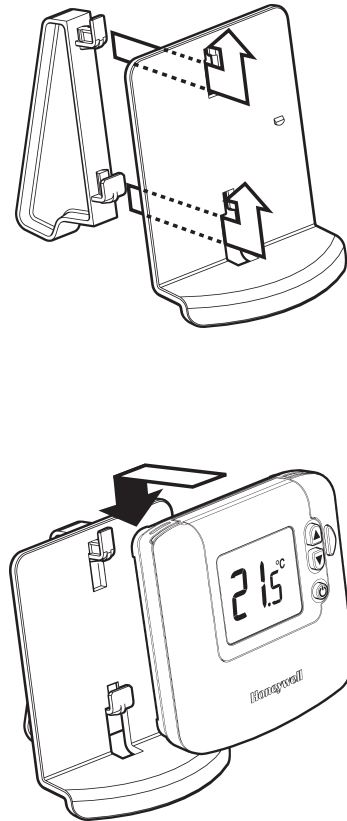

3 SYSTEM CONFIGURATION: ST9420C

3.1 ST9420C Installer Modes

ST9420C has 3 Installer Modes that enable the product to be customized for the application and for the needs of the User. Each adjustable feature is called a Parameter, and is represented by a number or letter ID and a value. The Modes are:-

- **Installer Setup**

Installer Setup allows features to be adjusted to suit user lifestyles or preferences, for example; backlight operation, automatic time-change, and selection of the default time programme. It is entered by a combination of button presses.

- **Set Service**

This is where the ST9420C Boiler Service Reminder and Shut-down Features can be set. This mode can only be entered by using a 4 digit PIN code. The factory supplied default PIN code is **0000**

- **Change PIN**

This mode allows the 4-digit PIN code to be adjusted. It is itself protected by the PIN code. When the code is changed this new code is used to enter both SET SERVICE and CHANGE PIN modes.

To Enter & Navigate Around the Installer Modes:

- Ensure the slider is in the **RUN** position, then press and hold **OK** and **Left** buttons together for 8 seconds. Ignore the 'NOT VALID' that is displayed for a few seconds. The message '**SET UP MENU**' will show briefly, to indicate you have entered the Setup menu. The *LoT™ Display* will continue to show messages indicating which Installer Mode is possible to select, for example '**SET INSTALLER OK ?**'
- Use the **Left** or **Right** buttons to navigate to the correct Installer Mode.
- Use the **OK** button to confirm you wish to enter that particular mode.

Installer Mode	LoT™ Display Message
Installer Setup	'SET INSTALLER OK ?'
Set Service	'SET SERVICE OK ?'
Change PIN	'CHANGE PIN OK ?'

To Exit Installer Modes:

You can exit the Installer Modes at any time by moving the slider to the next position and then back again to **RUN**. Any changes that have been confirmed will be saved and used.

Note: The Installer Modes and the Setup Menu will exit automatically after 10 minutes if the slider is not moved and no adjustments have been made in this time.

3.2 Boiler Service Reminder / Shut-down Feature

The ST9420C Programmer has a Service feature that can assist Social Housing Landlords to comply with the requirements of Regulation 36 of the Gas Safety (Installation & Use) Regulations 1998. It is intended as an aid to compliance but should not be used to replace the Landlord's existing Servicing procedures.

The ST9420C performs like a standard programmer. In addition it can automatically provide a Service Reminder and can be set to Shut-down the heating / hot water system once the gas Boiler Service becomes overdue. This helps to eliminate the potential for an incident to occur after the Landlord's Safety Certificate has expired.

The operation of the Service Feature is flexible. The landlord or installer can set the following:

- The service interval, in days
- An advance reminder for the tenant, by counting down days until service is due
- A contact telephone number to call to arrange the service – displayed on the LCD screen
- How the timer will operate when the service interval has expired.

The options include:

1. Continued normal operation with a Reminder message
2. Total shutdown of heating and hot water
3. "Prompt" mode – shutdown that will allow repetitive manual over-ride for one hour at a time.

The Service feature is configured from a special Installer Mode called '**SET SERVICE**'. Entry into this mode is only possible by entering a unique 4 digit PIN code.

Note: The ST9420C is supplied from the factory with the Service features **DISABLED**. They need to be enabled from the Installer Modes. See section **3.5 Set Service** for details.

3.3 Installer Setup

The wireless system can be set up to operate in a variety of different ways to suit the application, or the user lifestyle or preferences.

This setup is done via the ST9420C Installer Setup. The features that can be adjusted are called Installer Parameters, and are listed in the table below, along with a description of the options that are possible.

INSTALLER PARAMETER	Parameter Number	LoT™ Display Description	Default Value	Range of Values	Description [LoT™ Display Description]
24hr or am/pm clock display.	1	CLOCK MODE	12	12, 24	12 = am/pm display, [AM-PM] 24 = 24hr display [24 HOUR]
Configure backlight operation.	2	BACKLIGHT	2	0, 1, 2	0 = off, [NO B-LIGHT] 1 = on if button pressed, [B-L DELAY] 2 = on continuously [B-LIGHT ON]
Enable/disable auto time change.	3	AUTO TIME	1	0, 1	0 = disabled, [NO CHANGE] 1 = enabled [TIME CHANGE]
1-day or 5/2-day or 7-day operation.	4	UNIT TYPE	7	1, 5, 7	1 = 1-day operation, [1-DAY] 5 = 5/2-day operation, [5-2 DAY] 7 = 7-day operation [7-DAY]
Number of ON/OFFs per day.	5	ON PERIODS	3	2, 3	2 = 2 on/off per day, [2 PER DAY] 3 = 3 on/off per day [3 PER DAY]
Select default time programme.	6	DEF PROFILE	A	A, b, C	A = standard, [PROFILE A] b = at home, [PROFILE B] C = economy [PROFILE C]
* Set Hot Water Temperature	8	WATER TEMP	60	40 ... 85°C	Hot Water Temperature [SET WATER TEMP]
Optimum start	9	OP START	0	0, 1, 2	0 = no optimum start [NO OP-STRT] 1 = delayed start [DELAY STRT] 2 = optimum start on [OP-STRT ON]
Optimum start limit (Only available if OP START set to 2)	10	STRT LIMIT	1	1, 2, 3	1 = 1 hour [1 HOUR] 2 = 2 hours [2 HOURS] 3 = 3 hours [3 HOURS]
Optimum stop	11	OP STOP	0	0, 1	0 = disabled, [NO OP-STOP] 1 = enabled [OP-STOP ON]
Frost protection temperature	12	FROST TEMP	5	5 to 16°C	Frost protection temperature [SET FROST TEMP]
Minimum ON/OFF time	13	MIN ON-OFF	1	1, 2, 3, 4, 5 minutes	Minimum ON/OFF time [SET MIN ON-OFF]
Cycle rate	14	CYCLE RATE	6	3, 6, 9, 12	Number of boiler cycles [SET CYCLE RATE]
Proportional band width	15	PROP BAND	15 (=1.5°C)	15 ... 30 (=1.5 ... 3.0°C)	Control proportional band [SET PROP BAND]
Failsafe mode (loss of RF communications)	16	COMMS LOSS	0	0, 1	0 = off [HEAT OFF] 1 = on 20% [20 PERCENT]
** Reset all parameters	20	PROG RESET	1	0, 1	0 = do not reset [RESET OFF] 1 = default parameters [RESET ON]

* Only used if CS92A wireless cylinder sensor is connected.

** This parameter by default has a value of 1, unless you change any other parameter, when it will change to 0. Set it to 1 to reset all parameters back to defaults. Some parameters may not be displayed, depending on the settings made for prior parameters.

To Enter Installer Setup:

- Ensure the slider is in the **RUN** position, then press and hold the **OK** and **⏪** buttons together for 8 seconds. Ignore the **'NOT VALID'** that is displayed for a few seconds. The message **'SET UP MENU'** will show briefly, followed by **'SET INSTALLER OK ?'**
- Press the **OK** button to take you into the Installer Setup Parameter Menu.
- Parameter 1 is now available to change. This is to allow you to change the clock format from 12 hour AM/PM to 24 hour. At every step, the *LoT™ Display* will inform you what the parameter means and what option you have selected. The parameter number is shown on the display separated by a colon from the parameter value.
- You can change the parameter value by pressing the **⏩** or **⏪** buttons. At this point the description in the *LoT™ Display* will change and the parameter value will flash. If you press **OK** the value will stop flashing and will be saved for use.
- Press **OK** to move to the next parameter available for editing. The parameter number will change accordingly.
- Keep pressing **OK** to step around the list of parameters, and use **⏩** or **⏪** buttons to change the parameter value.
- Any parameter changes that have been confirmed with the **OK** button will be saved and used.

To Exit Installer Setup:

You can exit any Installer Mode at any time by moving the slider to the next position and then back again to **RUN**.

Note: *Installer Modes will exit automatically after 10 minutes if the slider is not moved.*

3.4 Installer Setup Flowchart

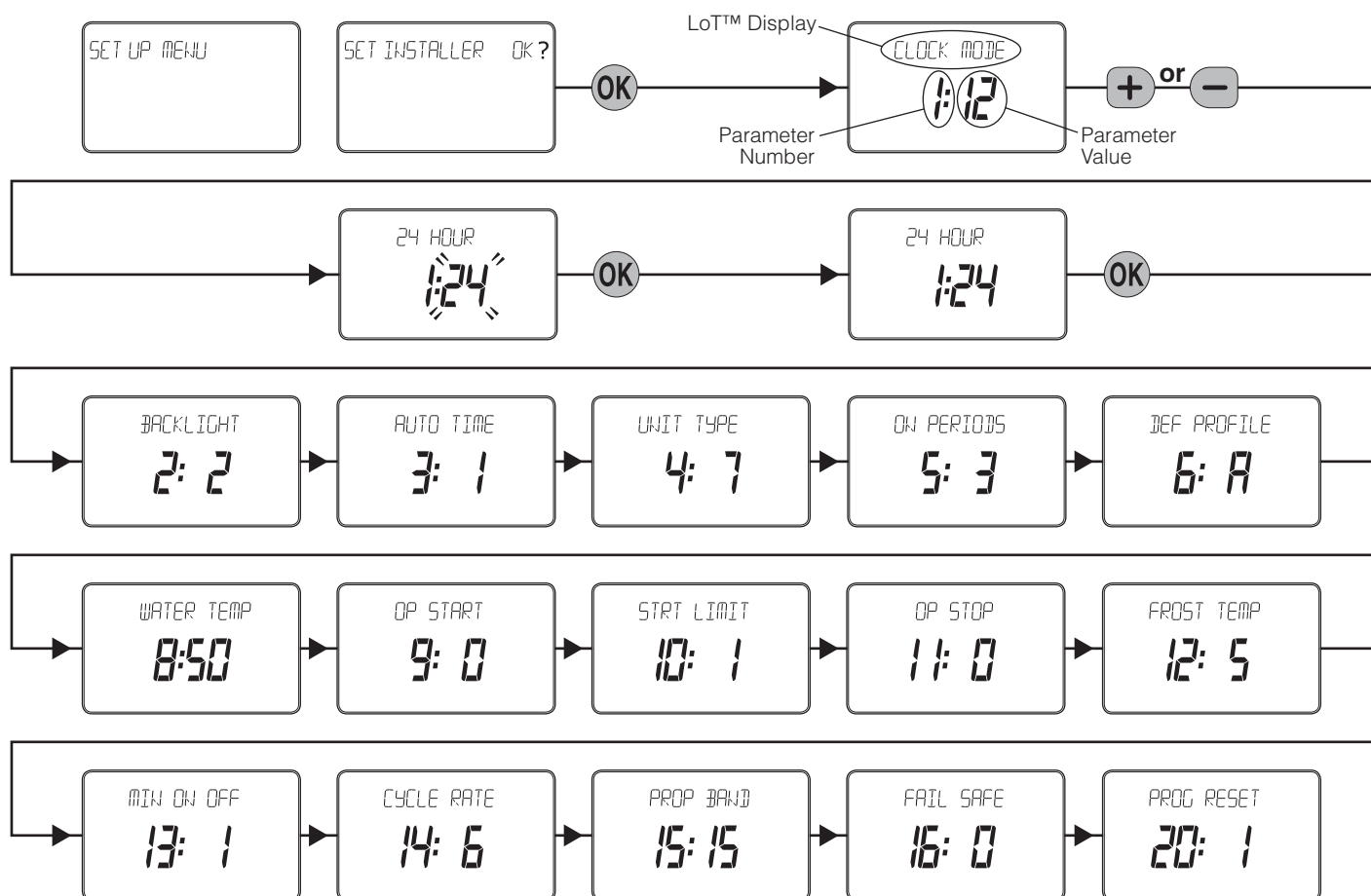

3.5 Set Service

Set Service parameters are listed in the table below, along with a description of the options that are possible. Most are only displayed if Service is enabled i.e. parameter AL is set = 1.

'SET SERVICE' PARAMETER	Parameter ID	LoT™ Display Description	Default Value	Range of Values	Description [LoT™ Display Description]
Enable or disable service alarm feature	AL	SERV MODE	0	0, 1	0 = disabled 1 = enabled [DISABLED] [ENABLED]
Number of days till next Service	d	SERV DAYS	364	001 to 400	001...400 000 = service is overdue [SET DAY COUNT]
Number of days for advance warning	Ad	DAYS NOTICE	28	0 to 28	0 ...28 [SET DAYS NOTICE]
Action taken at time-out	to	ACTION TYPE	2	0, 1, 2	0 = no action, 1 = switch off, 2 = 'prompt' mode [NO ACTION] [SWITCH OFF] [PROMPT MODE]
Number of EXTRA HOUR button presses allowed in 'Prompt' mode	bP	1HR BOOSTS	uL	uL, 1 to 99	uL = unlimited number, 1...99 = specified number of button presses, after which unit switches off [NUM BOOSTS]
Enable telephone call number display	tC	SHOW PHONE	0	0, 1	0 = disabled 1 = enabled [DISABLED] [ENABLED]
Enter contact telephone STD code	St	STD CODE	-----	1	When a ⊕ or ⊖ button is first pressed the LoT™ Display shows a row of dashes which can be adjusted using ⊕ or ⊖ buttons, then verified using the OK button.
Enter contact telephone number	nU	NUMBER	-----	1	When a ⊕ or ⊖ button is first pressed the LoT™ Display shows a row of dashes which can be adjusted using ⊕ or ⊖ buttons, then verified using the OK button.
* Reset 'SET SERVICE' parameters to default values	rS	ALRM RESET	1	0,1	0 = do not reset 1 = default parameters [NO RESET] [RESET]

* This parameter by default has a value of 1, unless any other parameter is adjusted, when it will change to 0. Set it to 1 to reset all parameters back to defaults

3.5 Set Service (cont.)

To Enter Set Service Mode:

- Enter **Installer Modes** (as described on Page 8) and navigate to **SET SERVICE** mode. In response to the query **'SET SERVICE OK ?'** press the **OK** button to enter SET SERVICE.
- The message **'ENTER PIN'** will now be displayed, along with the 4-digit entry code format 0---. The first digit will be flashing, to indicate it can be changed. Use the **+** or **-** buttons to set the first digit, and press **OK** to confirm the digit.
- At this point the first digit will stop flashing and the second digit will begin to flash, indicating it can be changed.
- Proceed in this way to enter the 4 digits of the PIN code. Upon confirming the last digit, if the PIN was incorrect, the message **'INVALID'** will be displayed, and then the whole process will start again from step **b.** above.
- If the PIN was correct, the first SET SERVICE parameter **'AL'** will be available to change. This allows you to enable or disable all the service alarm features. At every step, the *LoT™ Display* will inform you what the parameter means and what option you have selected. The parameter ID is usually shown on the display separated by a colon from the parameter value.
- You can change the parameter value by pressing the **+** or **-** buttons. At this point the description in the *LoT™ Display* will change and the parameter value will flash. If you press **OK** the value will stop flashing and will be saved for use.
- Press **OK** to move to the next parameter available for editing. The parameter ID will change accordingly.
- Keep pressing **OK** to step around the list of parameters, and use **+** or **-** buttons to change the parameter value.
- Any parameter changes that have been confirmed with the **OK** button will be saved and used. Some parameters may be made invalid by a previous parameter setting, and these will be skipped over in the setting process.

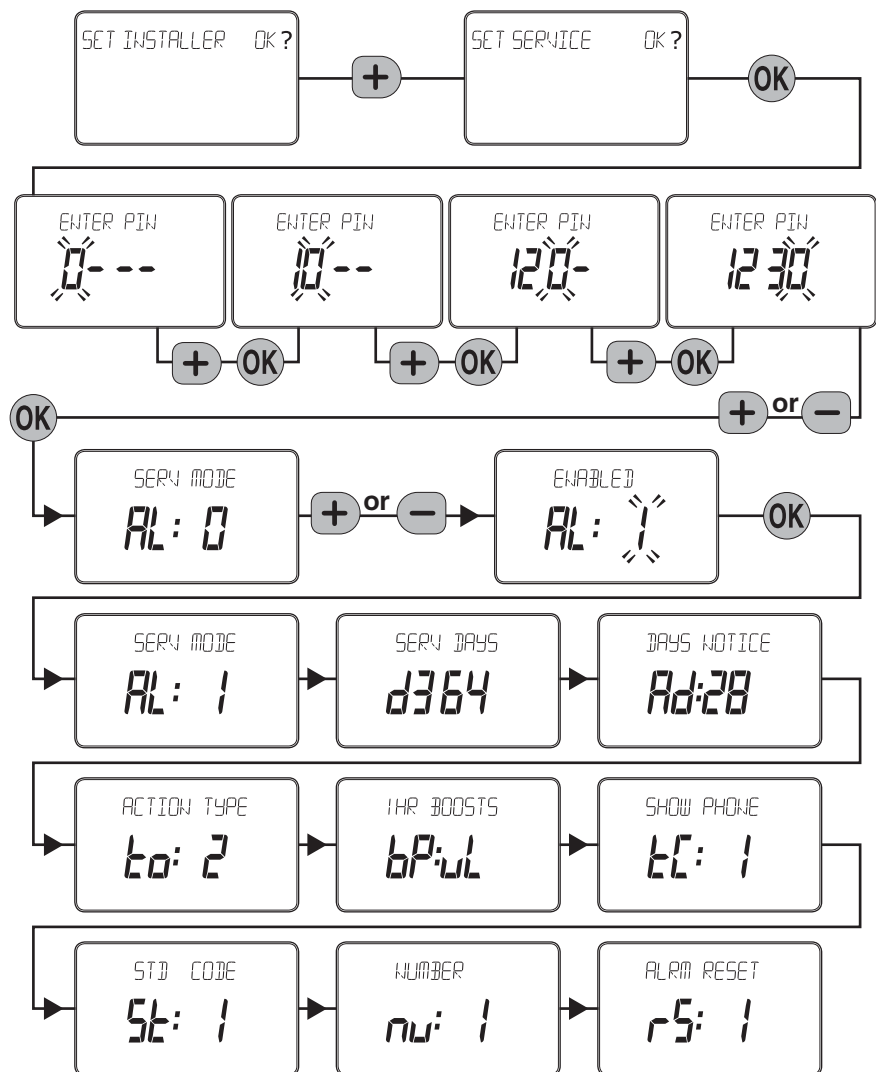

To Exit Set Service Mode:

You can exit Set Service Mode at any time by moving the slider to the next position and then back again to **RUN**.

3.6 Change PIN

If you intend to change the PIN code, please ensure you take a note of the new code that you are setting.

The process for changing the current PIN code is as follows:

- Enter **Installer Modes** (as described on Page 8) and navigate to **CHANGE PIN** mode. In response to the query '**CHANGE PIN OK ?**' press the **OK** button to enter **CHANGE PIN** mode.
- The message '**ENTER PIN**' will now be displayed, along with the 4-digit entry code format **0---**. The first digit will be flashing, to indicate it can be changed. Use the **+** or **-** buttons to set the first digit, and press **OK** to confirm the digit.
- At this point the first digit will stop flashing and the second digit will proceed to flash, indicating it can be changed.
- Proceed in this way to enter the 4 digits of the old PIN code. Upon confirming the last digit, if the PIN was incorrect, the message '**INVALID**' will be displayed, and then the whole process will start again from step **b.** above.
- If the PIN was correct the message '**SET NEW PIN OK ?**' will appear. As before, use the **+** or **-** buttons to set the digits, and the **OK** button to confirm. Upon confirming the final digit, the message '**PIN SET**' will be displayed, and the new PIN code will be held on the screen for 5 seconds, to give you time to note it down.
- After setting the new PIN code, you will be taken back to the **SETUP MENU**.

3.7 What the User Will See When a Service is Due



If the advance warning has been configured, the screen will flash this message every few seconds, and the User should telephone to arrange a service call before the final date when the service is due.

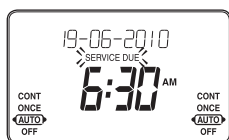

When the boiler service is overdue the screen will keep flashing the words '**SERVICE DUE**' every second.

If the **NO ACTION** option has been selected, the unit will continue to operate as normal and the real time will continue to be shown.



If the **SWITCH OFF** or **PROMPT** Actions have been selected, the '**SERVICE DUE**' message will flash and the word "**OFF**" will appear on the display. The boiler has been switched off to ensure the safety of the User. A service appointment should be arranged immediately.

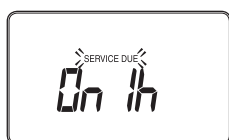

In **PROMPT** operation, the User can obtain limited use of the boiler by pressing the **HEATING** or **HOT WATER EXTRA HOUR** buttons. Each button press will allow operation of the boiler for 1 hour at a time, and the screen will display the message '**On 1h**', as shown. A service appointment should be arranged immediately.

If a contact telephone number has been programmed into the ST9420C, a message will appear on the *LoT™ Display* indicating the number that should be called.

3.8 Resetting the Service Timer Function

If the Service Timer function is enabled you will be required to reset it after the boiler service has been carried out.

The process for resetting the Service Timer is as follows:

- Enter **Installer Modes** (as described on page 8) and navigate to **SET SERVICE** mode. In response to the query '**SET SERVICE OK ?**' press the **OK** button to enter **SET SERVICE** mode.
- If you no longer require the Service Timer, disable it by setting parameter **AL** to **0** and confirm with the **OK** button.
- If you still require the Service Timer, set the number of days until the next service is due using parameter **d** and confirm with the **OK** button.
- Whilst in **SET SERVICE** mode, use the opportunity to change any other service parameters if required.
- Exit by moving the slider to the next position and back again to **RUN**.

4 SYSTEM CONFIGURATION: DT92E

4.1 DT92E Installer Mode

Like ST9420C, DT92E also has an Installer Mode to enable it to be customized for the application. Each adjustable feature is called a Parameter, and is represented by a letter ID and a value on the display, as shown.

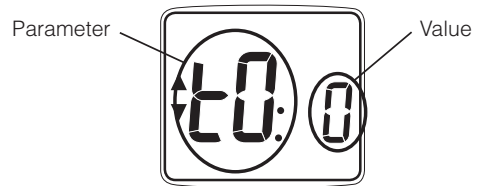

The Parameters are listed in the table below:-

INSTALLER PARAMETER	Parameter	Default Value	Range of Values	Description
Temperature measurement offset	t0	0	-3 to 3°C	Offset to measured temperature
Upper setpoint limit	uL	35	21 to 35°C	Upper set temperature limit in °C
Lower setpoint limit	LL	5	5 to 21°C	Lower set temperature limit in °C
Energy saving ECO setpoint	ES	18	5 to 35°C	Energy saving ECO set temperature in °C
Reset parameters to factory settings	FS	1	0, 1	Parameter will be set to 0 if any of the other parameter values have been changed. Set to 1 to get back to factory settings.

To Enter Installer Mode:

- Hold the button for 2 seconds until DT92E is in standby mode
- Hold and buttons for 3 seconds until the word 'Inst' appears on the display
- Press the button

The first parameter is now ready to be changed

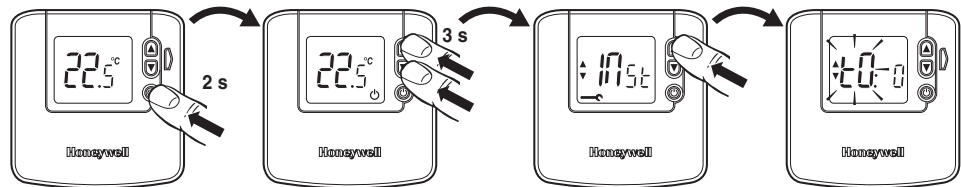

To Select a Parameter:

Use the and buttons to move from one parameter to the next. Stop at the Parameter you wish to change.

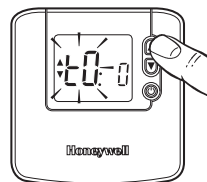

To Change a Parameter:

Use the button to select the parameter value, then the and buttons to change the value. Confirm the change by pressing the button again to take you back to the parameter.

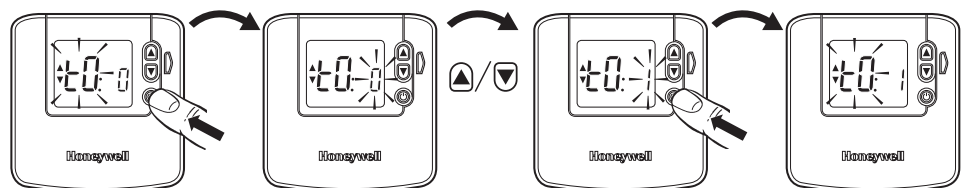

To Exit Installer Mode:

Hold the button for 3 seconds to exit Installer Mode.

Note: The Installer Mode will exit automatically after 10 minutes if no adjustments have been made in this time.

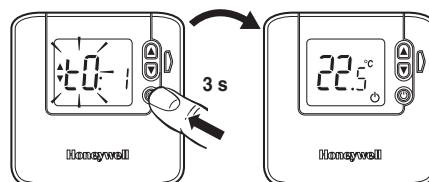

5 BINDING / RE-BINDING PROCEDURE



5.1 Binding

2-way RF devices that communicate with each other achieve this through having each others unique addresses written in their memories. This allows each device to know which other device to communicate with. The process of writing these addresses is know as Binding.



All devices in the pack are pre-bound at the factory. The binding operation is only required if:

- any of the system components are replaced
- pre-bound system pack components have been mismatched
- additional RF components are required for the application

5.2 ST9420C Guided Binding Menu

The ST9420C is the communications 'hub' of the entire system, so other RF devices are bound to it and not to each other. ST9420C has a special 'Guided Binding Menu' that allows you to bind other devices to it in a logical way. Devices are bound into special 'slots' and there are rules governing what can be bound into which slot. This ensures binding errors are minimised and applications are correctly set up. When in 'Guided Binding Menu' the  and  buttons are used to navigate around.





Sensor binding (refer to section 5.5 for sequence of steps)

It is possible to bind up to 2 sensors to ST9420C, in separate binding slots, a DT92E room thermostat or a CS92A cylinder thermostat, or both. If the display shows dashes it means there is nothing already bound in the slot. If the display shows '**bnd**' it means there is something already bound, and the icon helps identify what – a  for the DT92E and a  for the CS92A. Only a DT92E wireless room thermostat is bound in this system, because the cylinder thermostat is wired.

Control and boiler binding

Once a valid sensor is bound, it is then possible to bind an output device, such as a BDR91T relay box. If this is to control remote zone valves for the heating and hot water zones, then use the CONTROL binding slots. This is not required in this system. For more information about other applications, contact the Honeywell Technical Help desk, or go to the website (details on back page of this manual).

Binding table by application

Application	DHW Sensor	Heating Sensor	DHW Control Output	Heating Control Output	Boiler	Binding Required
	SENSOR	SENSOR	CONTROL	CONTROL	BOILER	
						
94-1	-- --	DT92E	-- --	-- --	-- --	Supplied pre-bound

General Binding Notes

- To bind 2 devices together, BOTH must be put into Binding Mode.
- With both devices in binding mode, you must send the binding signal from one device to the other:
 - To bind a sensor, the signal is sent from the sensor.
 - To bind an output device, the signal is sent from the ST9420C.

5.3 Guidance for Replacing Devices or Changing the Application

Situation	Binding Action
1. Replacing faulty DT92E or CS92A	<ul style="list-style-type: none"> • Bind new sensor over previous binding in SENSOR slot.
2. Reconfiguring system by removing one of the sensors (e.g. removing DT92E or CS92A).	<ul style="list-style-type: none"> • Cancel existing SENSOR binding in timer. • Cancel binding in sensor that has been removed. • Reconfigure binding, starting with new sensor first.

5.4 Binding Menu Display

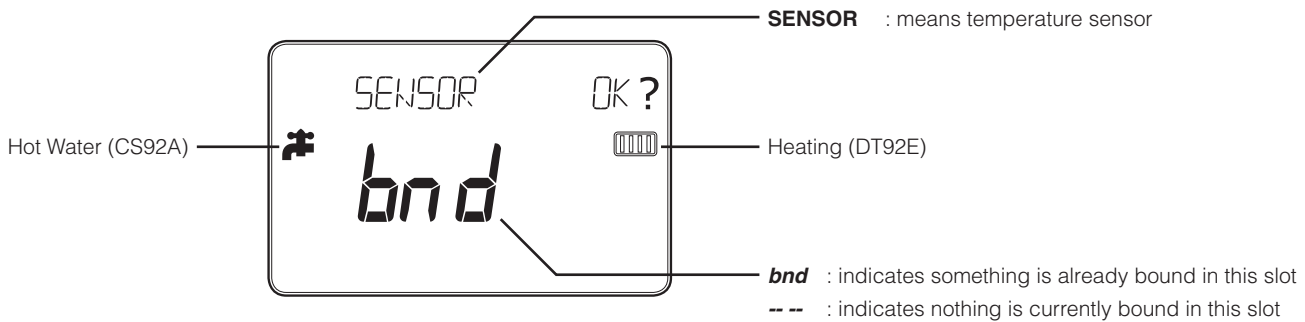

5.5 How to Bind DT92E to ST9420C

- Ensure the ST9420C slider is in the **RUN** position, then press and hold \ominus , \oplus and **Heating MODE** buttons for 8 seconds to access the Guided Binding Menu. The message **'BIND MENU'** will show briefly, followed by the binding display.
- From the Guided Binding Menu, select the Room Temperature **SENSOR** binding mode.
- Refer to the table in Section 5.3 to determine whether you require to cancel any binding. If the display shows dashes it means there is nothing already bound in the slot. If the display shows **'bnd'** it means there is something already bound. When in 'Guided Binding Menu' the \ominus and \oplus buttons are used to navigate around.
- Any existing binding can be cancelled by holding the OK button for 8 seconds and the *LoT™ Display* will say **'RESET'** for a few seconds.
- Press the OK button on ST9420C to put it into binding mode, ready to receive the binding message from the sensor. The display will flash and the message **'BINDING'** will be shown to indicate ST9420C is waiting for this message.
- Now bring DT92E (or its front section, minus mounting plate) to approximately 1 metre from ST9420C.
- Put DT92E into binding mode as shown.
 - Press and hold the OK button for 2 seconds
 - Hold the \uparrow and \downarrow buttons for 3 seconds until display shows **'Inst'**
 - Press the \downarrow button and the display shows **'Cont'**

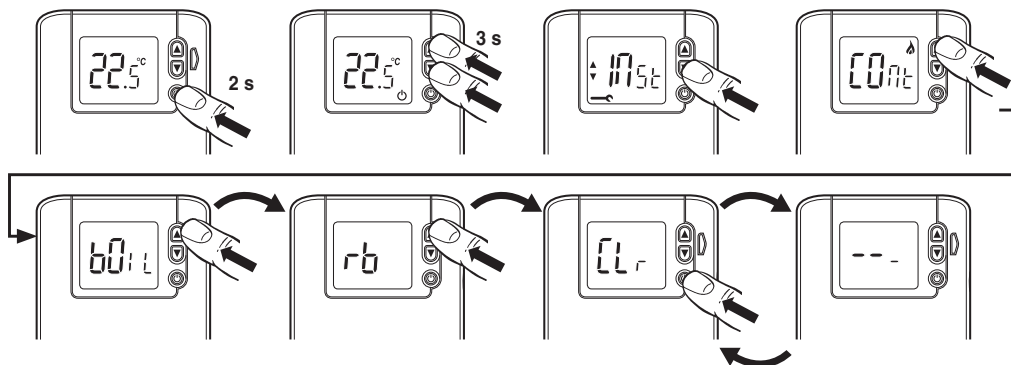

- If you do not need to cancel existing binding in DT92E (see section 5.3) skip this step and go straight to step i.
 - Keep pressing the \uparrow button until the display shows **'CLR'**
 - Press the OK button to clear existing binding data
 - Now put DT92E into binding mode by pressing the \uparrow button again. The display will show **'Cont'**.

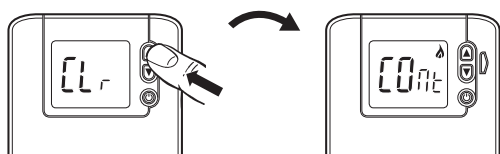

- Press the OK button on DT92E to send the binding message to ST9420C. If binding was successful DT92E will exit binding mode, and will show **'SYnc'** on its display for up to 4 minutes, as communication and synchronisation are established. The ST9420C display will stop flashing, **'bnd'** will be shown, and the *LoT™ Display* will say **'COMPLETE'** for a few seconds.
- If binding was unsuccessful, repeat step i. If this fails, repeat steps e. to i. again. If binding was successful, proceed to step k.
- Exit Guided Binding Menu by moving the ST9420C slider to the next position and then back again to **RUN** (it will exit automatically after 10 minutes if the slider is not moved).
- Now go to section 2.3 to verify communication by using the Signal Strength check.

6 COMMISSIONING THE SYSTEM

6.1 System Test Checklist

1	Check ST9420C has powered up correctly and the display is not blank. Now set Heating and Hot Water operating modes to AUTO .	<input type="checkbox"/>
2	Check DT92E has powered up correctly and the display is not blank.	<input type="checkbox"/>
3	Configure DT92E as required (see Section 3 for how to do this). Remember to make a note of any changes in the Configuration Data section of the User Guide.	<input type="checkbox"/>
4	Change the temperature setpoint on DT92E to 35°C by pressing the ▲ button. (If DT92E is currently off, hold the ☺ button for 2 seconds to take it back to run mode).	<input type="checkbox"/>
5	Now go to ST9420C. With Heating and Hot Water operating modes set to AUTO , switch Heating and Hot Water on and off using the OVERRIDE buttons, to ensure the system is operating correctly.	<input type="checkbox"/>
6	Check the factory-set day, date, and time are correct and adjust if necessary. Refer to User Guide for details.	<input type="checkbox"/>
7	If required, enter Installer Setup Mode and adjust Installer Parameters to match the lifestyle and needs of the User. Remember to make a note of these parameter changes in the Configuration Data section of the User Guide.	<input type="checkbox"/>
8	If required, enter Set Service Mode and enable the Boiler Service Reminder, and set the appropriate Service parameters.	<input type="checkbox"/>
9	Set the DT92E to the temperature required by the User (20°C is recommended). Set the hot water temperature to the preferred value.	<input type="checkbox"/>

6.2 Completion Checklist

1	Explain the operation of the products to the User, and help them to set their Heating and Hot Water programmes. ST9420C has 3 built-in profiles that can be used as a basis for typical User programmes.	<input type="checkbox"/>
2	Explain when the User should contact someone to arrange a Service Visit, and what you have programmed to happen when the Service is overdue.	<input type="checkbox"/>
3	If required, attach the self-adhesive programme guide label to the underside of the ST9420C cover flap. The label is supplied in the box.	<input type="checkbox"/>
4	Write the date of installation, your name and telephone number in the space provided in the User Guide, in the section 'Boiler & System Service Log'.	<input type="checkbox"/>
5	Remember to leave the User Guide and Installation Instructions with the User and remind them to keep them in a safe place. This forms part of a Home Information Pack.	<input type="checkbox"/>

This product and its associated documentation and packaging are protected by various intellectual property rights belonging to Honeywell Inc and its subsidiaries and existing under the laws of the UK and other countries. These intellectual and property rights may include patent applications, registered designs, unregistered designs, registered trade marks, unregistered trade marks and copyrights.

Honeywell reserves the right to modify this document, product and functionality without notice. This document replaces any previously issued instructions and is only applicable to the product(s) described.

This product has been designed for applications as described within this document. For use outside of the scope as described herein, refer to Honeywell for guidance. Honeywell cannot be held responsible for misapplication of the product(s) described within this document.

Manufactured for and on behalf of the Environmental and Combustion Controls Division of Honeywell Technologies Sàrl, ACS-ECC EMEA, Z.A. La Pièce 16, 1180 Rolle, Switzerland, by its Authorised Representative Honeywell Inc.

Honeywell Control Systems Ltd.

Arlington Business Park,

Bracknell, Berkshire

RG12 1EB

Technical Help Desk: 08457 678999

www.honeywelluk.com



50047644-007 A
© 2011 Honeywell International Inc.

Honeywell