

CONDENSING

 **IMMERGAS**



NEW RANGE

VICTRIX MAIOR TT RANGE

Wall-hung combi
and only-heating
condensing boiler



WE ARE READY TO DO OUR BIT FOR THE ENVIRONMENT

We are talking about a very important European Union directive, an effective strategy that will drive to in reduced pollution and therefore improve the life of citizens all over Europe. The ErP directive (2009/125/CE) - the acronym stands for "**Energy Related Products**" - assesses very precise guidelines for design and the manufacturing of eco-compatible products and defines the minimum mandatory requirements for the efficiency and environmental performance of all power-consuming devices.

The goal is to reach the famous 20-20-20 by 2020. The repetition of the number 20 makes it easier to remember the **three key targets of the directive**:

- **INCREASE THE EFFICIENCY OF ENERGY USING APPLIANCES BY 20%**
- **REDUCE THE EMISSION OF CARBON DIOXIDE (CO₂) IN THE ATMOSPHERE BY 20%**
- **RAISE THE PERCENTAGE OF RENEWABLE ENERGY ON FINAL CONSUMPTION TO 20%**

Two deadlines have been set to establish a road map for the adjustment.

Starting from **1 AUGUST 2015** it will be mandatory **to place on the market** appliances fitted with energy efficient circulators.

Starting from **26 SEPTEMBER 2015** the ErP and ELD Directives will enter into force requiring energy labelling of all the appliances **placed on the market**.

Placing on the market means the first time the product is invoiced by Immergas to the dealer. If an appliance is placed on the market before 1 August/26 September 2015, **it can be sold, installed and put into service without time limits**. The ErP and ELD regulations are not retroactive.



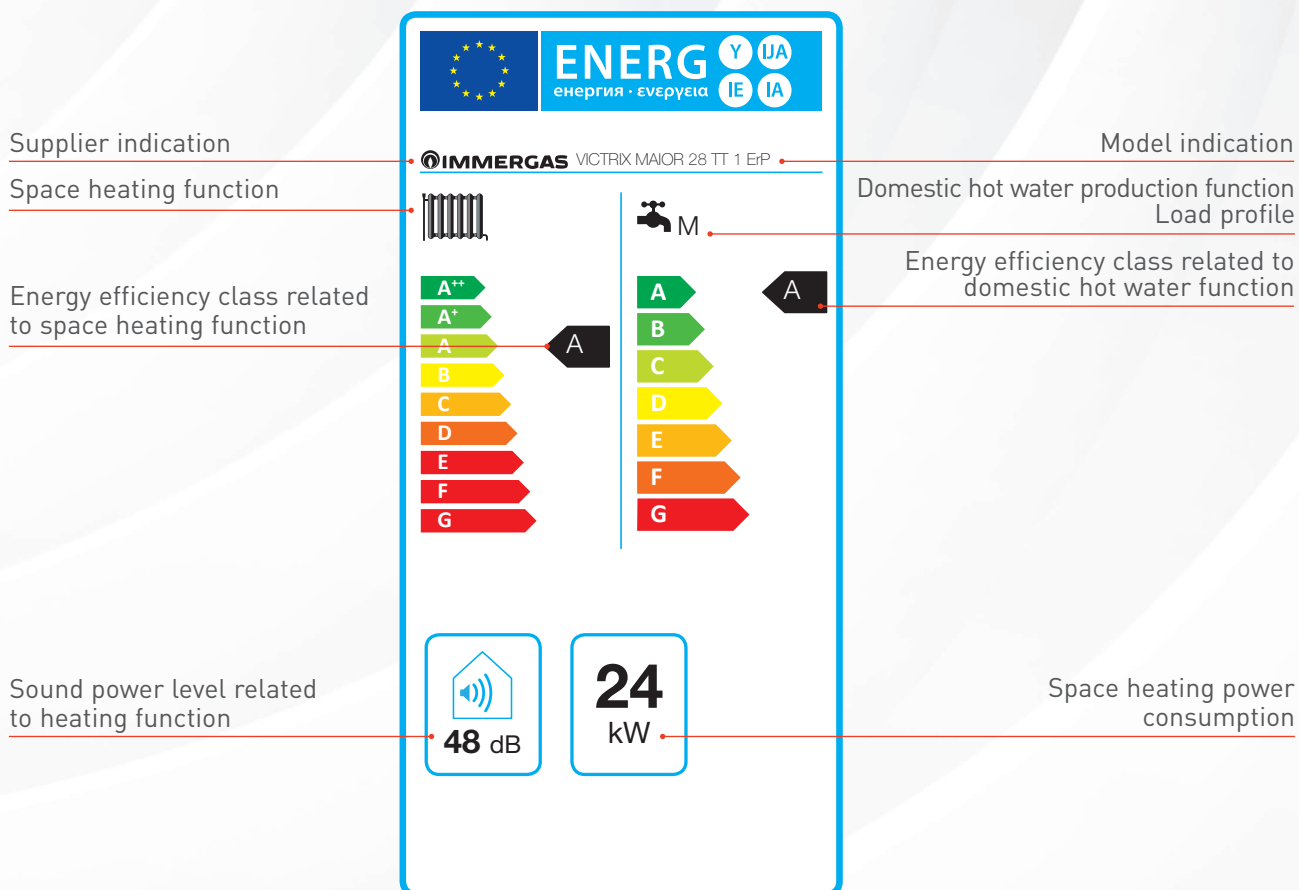

ELD: EVERYTHING CLEAR IN THE LABEL

The European Union has made the new energy labelling system mandatory to enable consumers to see immediately the level of environmental compatibility of every single product. The Energy Labelling Directive (2010/30/CE) requires every product subject to the ErP Directive to bear a label highlighting not only the energy efficiency class but also other performance factors such as sound power level, use and power consumption.

IMMERGAS WELCOMES THESE ADJUSTMENTS WITH PARTICULAR CONVICTION, IN THE KNOWLEDGE THAT ONLY A MARKET THAT STIMULATES TECHNOLOGY WITH THE HIGHEST ENERGY EFFICIENCY CAN BE RESPECTFUL OF THE ENVIRONMENT.



VICTRIX MAIOR TT RANGE

Comfort, savings, Top Tech technology

This is the most advanced range in the “**Top Tech**” platform, produced in the high-automation lines of the original headquarters of Immergas, in Brescello.

CONDENSATION TECHNOLOGY FOR HIGHER ENERGY CLASS

Two instantaneous versions (28 and 35 kW) and a heating-only version (35 kW): together they create a perfect range to meet the **new European Directives** on energy use, which is increasingly focused on condensation technology. All the models feature a low consumption modulating circulator, designed to achieve high efficiency classification levels for room heating and hot water production. This is why VICTRIX MAIOR TT is **ideal in new installations** and for **replacing existing** units.

HIGH OUTPUT, LOW CLOGGING RISK

The condensation module is innovative: it ensures **high output and head on the heating circuit**, low clogging risk from system impurities and improved **resistance to corrosion** thanks to the special metal alloy used.

HIGHER ENERGY SAVING, HIGHER HOT WATER COMFORT

The new circuit board modulates the heating power of the boiler up to 12% and together with the **low consumption** circulator affords significant energy savings. The instantaneous models feature flow regulator and hot water sensor to achieve **high hot water comfort**: 3 stars *** according to standard EN 13203 -1. For systems with large hot water consumption or simultaneous service use, an “X” version is available which can be combined with boiler units of various sizes.





DOMINUS. THE APP FOR ONLINE BOILER CONTROL

VICTRIX MAIOR TT can be remotely controlled by means of the new DOMINUS app (available from December 2015). This simple, intuitive app lets you control your boiler and display operation data on your tablet, smartphone and portable PC. Using the optional Wi-Fi transmitter kit (code 3.026273), installed before your modem/router wireless (not supplied by Immergas), you can communicate with the boiler's circuit board from any location.

ADVANTAGES OF DOMINUS APP

- ▶ Intuitive navigation and simple use on smartphone and tablet touchscreens
- ▶ Remote control with direct access to main system settings, such as:
 - Operation status
 - Heating/DHW temperature setting
 - Ambient temperature
 - Reception of error messages
 - Generator resetting
- ▶ Accessible for use anywhere at any time
- ▶ Easy installation
- ▶ Encrypted security access

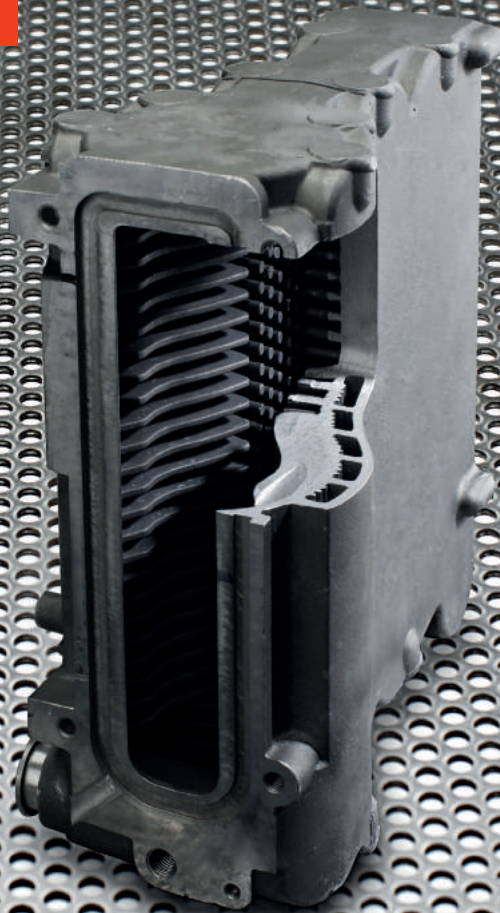

HIGH HYDRAULIC PERFORMANCE

The design of the **new condensing module** features **wide water passages** to enable excellent flow rate and head performance even on old heating systems. This also means **reduced clogging risk** when impurities are present in the water of the system.

The special aluminium-silica-magnesium alloy used for construction, together with the accessories used, makes the unit particularly resistant to corrosion. The ascending pathway of the water circuit in the exchanger flows countercurrent to the flame. The closely fitted elements increase the exchange surface ensuring high water output. It is important to keep the pH value of the the water in the heating system between 6,5 and 8,5 and a hardness of 15 °F.

INDOOR AND OUTDOOR INSTALLATION

VICTRIX MAIOR TT is approved for outdoor installation provided it is partially protected from the weather (rain and snow), for example by installing it under a balcony. An electrical resistance kit is available to expand antifreeze protection from -5 °C to -15 °C.

VERSION “X”

VICTRIX MAIOR TT X 35, can be combined with a separate storage tank unit through a special optional kit (code 3.024609). The kit consists of 2 pipes to connect the three-way valve (standard in the boiler) at separate storage tank. The separate storage tank Units come in a range of models from 80 to 300 litres, to be selected according to the system requirements of domestic hot water production.

EASY TO UNDERSTAND AND USE

User-friendly control knobs and selection keys, LCD screen for displaying operation status: everything is easy to access through the dashboard door and simple for anyone to use.

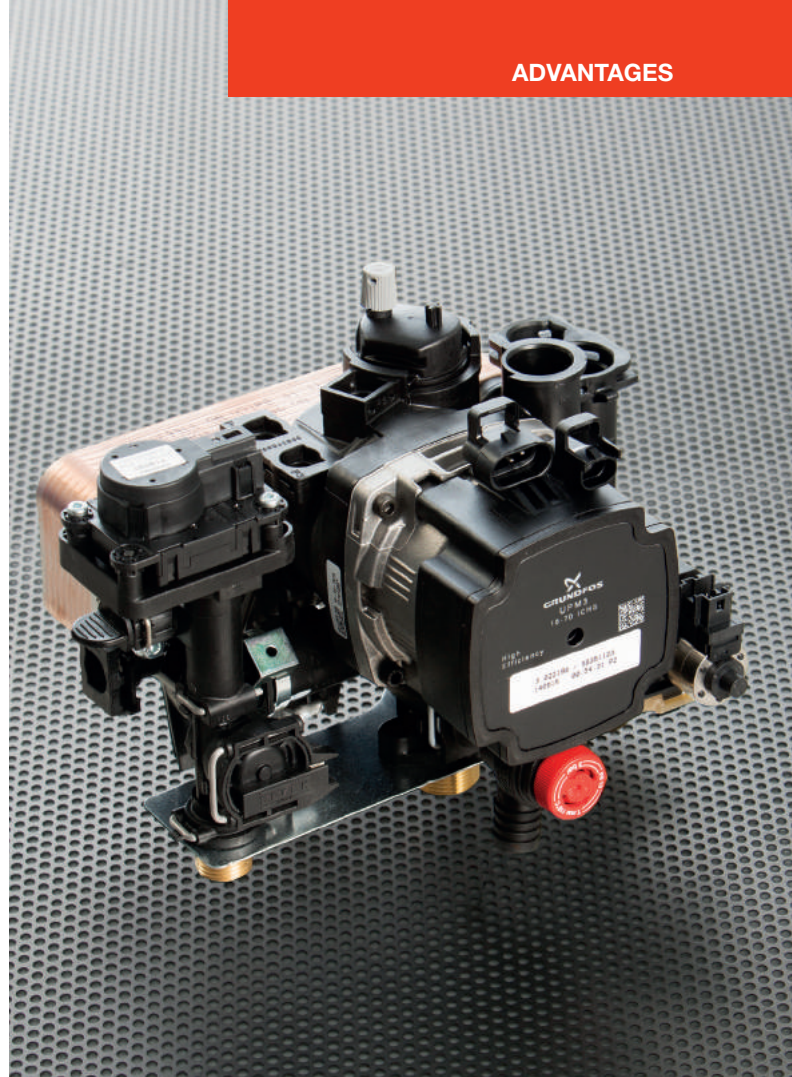
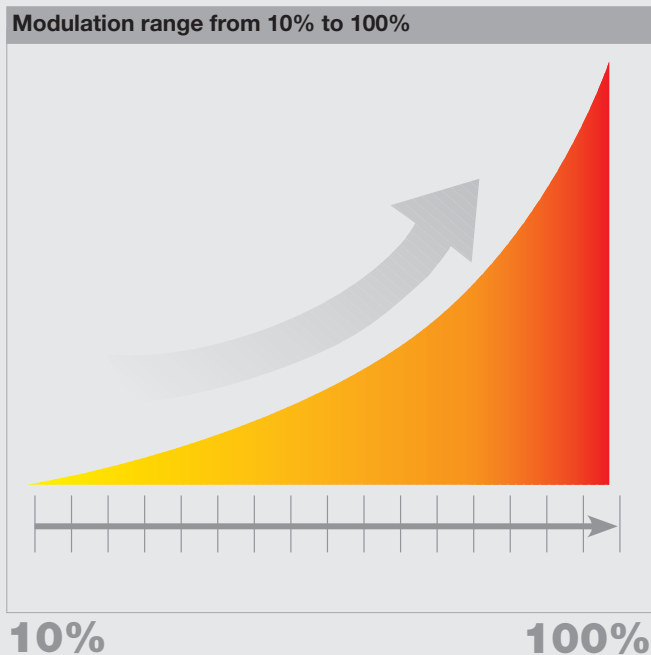

CLASS “A” CIRCULATOR

The low consumption circulator affords high energy savings compared to traditional circulators. The presence of two supply and return NTC sensors make it possible to continuously modulate operating conditions to the system's demand, increasing seasonal efficiency. The circulator can be set to the following operating modes: **Constant Δt , Proportional head or Constant Speed**.

WIDE MODULATION RANGE

The new circuit board reduces running costs thanks to the particularly high performance even with low energy absorption, such as during in-between seasons. Thanks to the wide modulation range, from 10% to 100% heat output 35 kW models and from 12% to 100% 28 kW models, it enables high seasonal efficiency.

ELECTRONIC AIR/GAS CONTROL

The new electronic gas valve enables air/gas control by means of a multifunction electrode housed inside the combustion chamber; the circuit board self-adapts combustion parameters in case of variations in the density of air or fuel. Another important feature is that nozzles do not need to be replaced if gas is changed (methane/LPG): the boiler is supplied as a **single product code** and you simply need to make adjustments in the circuit board software.

HIGH DHW PERFORMANCE

The hot water circuit of the MAIOR TT instantaneous versions feature an electronically-controlled water flow regulator. Hot water temperature is controlled by two sensors. This enables extremely high performance levels, such as: maximum quantity of hot water at the required temperature, constant outlet temperature and constant quantity of hot water regardless of changes in inlet pressure from water mains.





VICTRIX MAIOR TT/35 X TT

Wall-hung combi and only-heating condensing boiler

MAIN CHARACTERISTICS

- ↘ Available 28 and 35 kW combi version and 35 kW heating-only version
- ↘ Ecofriendly - low NOx emissions (class 5)
- ↘ Design with panel cover flap
- ↘ New condensing module with high circulation
- ↘ Modulating heat output from 10 to 100%
- ↘ Gas adaptive through control board parameters; only one product code (natural gas)
- ↘ Low consumption modulating pump
- ↘ NTC probes for system delivery and return as standard
- ↘ Adjustable system by-pass
- ↘ Possible installation outdoors in partially protected areas
- ↘ Standard frost protection to -5 °C expandable to -15 °C with optional kit
- ↘ Green Series flue systems
- ↘ Standard connection group
- ↘ Storage tank connection kit for "X" models
- ↘ Same hydraulics and gas connection positions as current models



Technical data	Unit of measurement	VICTRIX MAIOR 28 TT 1 ErP	VICTRIX MAIOR 35 TT 1 ErP	VICTRIX MAIOR 35 TT X 1 ErP
Code		3.024882	3.024883	3.024884
CE certificate		0694CP7233	0694CP7233	0694CP7233
Maximum nominal heat input (C.H. mode)	kW	24,9	34,9	34,9
Maximum nominal heat input (D.H.W. mode)	kW	29,1	34,9	34,9
Minimum nominal heat input	kW	2,9	3,6	3,6
Maximum nominal heat output (C.H. mode)	kW	24,0	34,2	34,3
Maximum nominal heat output (D.H.W. mode)	kW	28,0	34,2	34,2
Minimum nominal heat output	kW	2,8	3,5	3,5
Efficiency at nominal heat output (80/60 °C)	%	96,6	97,9	97,9
Efficiency at 30% of load (80/60 °C)	%	102,5	103,2	103,2
Efficiency at nominal heat output (40/30 °C)	%	102,3	106,0	106,0
Efficiency at 30% of load (40/30 °C)	%	108,3	108,5	108,5
Weighted CO with natural gas	mg/kWh	29,0	24,0	24,0
Weighted NO _x with natural gas	mg/kWh	25,0	26,0	26,0
D.H.W. flow rate for continuous service (Δt=30 °C)	l/min	13,3	16,3	-
D.H.W. circuit max pressure	bar	10,0	10,0	-
Set heating temperature	°C	20 - 85	20 - 85	20 - 85
Central heating circuit max pressure	bar	3	3	3
Central heating expansion vessel capacity	litres	10	10	10
Fan available head (max/min)	Pa	203/100	258/116	258/116
Electric protection index	IPX	5D	5D	5D
Full appliance weight	kg	33,9	35,8	35,8

Flow rate/head graph

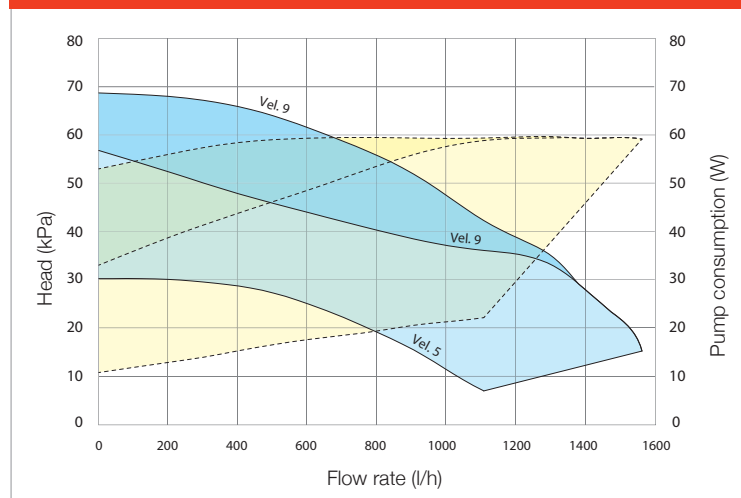

Key:

- Available head for central heating with excluded by-pass
- Available head for central heating with inserted by-pass
- Pump consumption with excluded by-pass
- Pump consumption with inserted by-pass



PRODUCT INFORMATION (IN ACCORDANCE WITH REGULATION 811/2013)

In accordance with the ELD directive, we include the label of each boiler to enable customers to evaluate the products. The labels are shown in the documentation accompanying the units as well as on the immergas.com website in each product's page.

VICTRIX MAIOR 28 TT 1 ErP

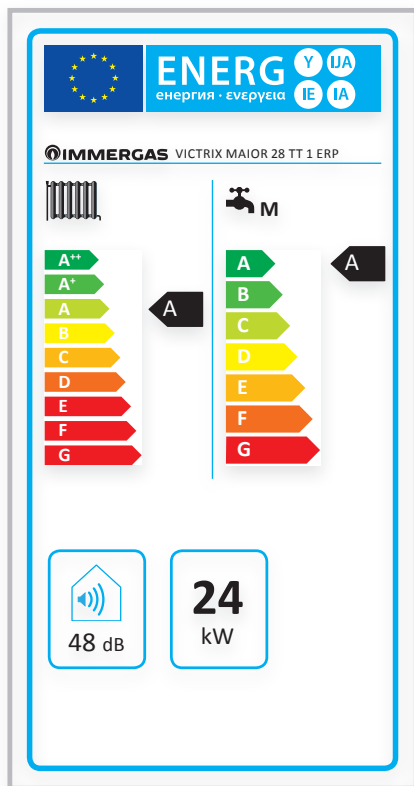

VICTRIX MAIOR 35 TT 1 ErP

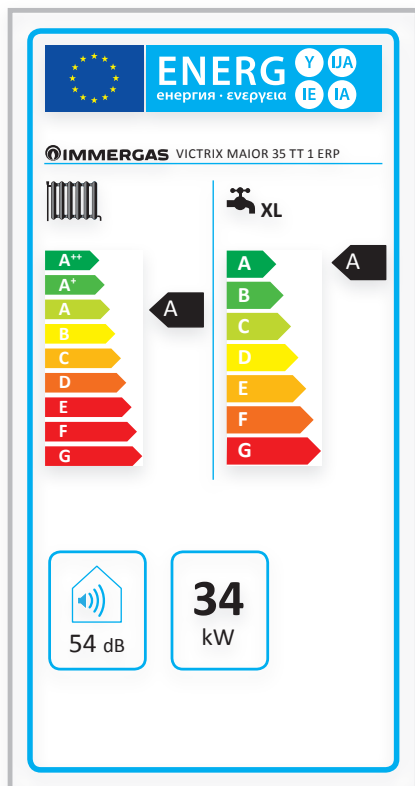

VICTRIX MAIOR 35 X TT 1 ErP

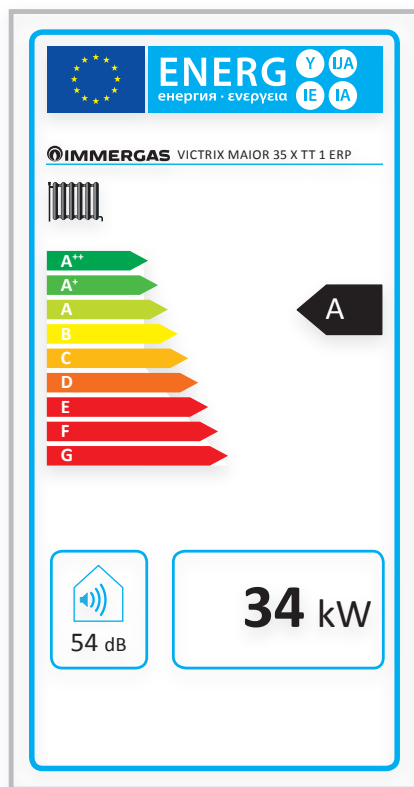

Dimensions and connections

VICTRIX MAIOR 28/35 TT 1 ErP

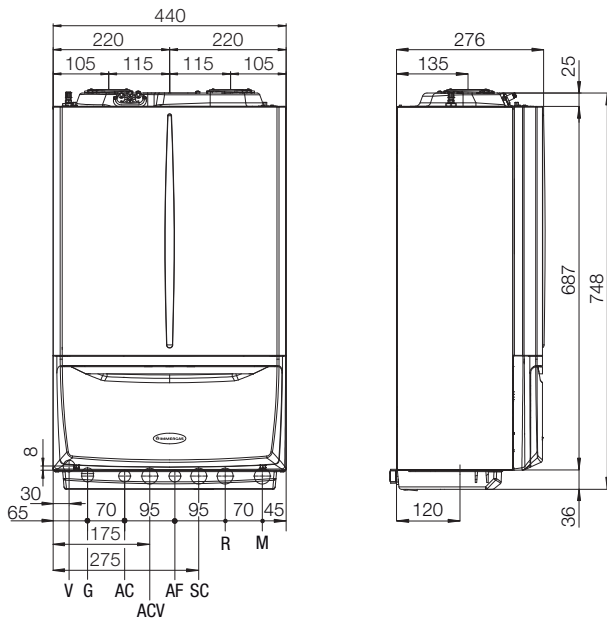

VICTRIX MAIOR 35 X TT 1 ErP

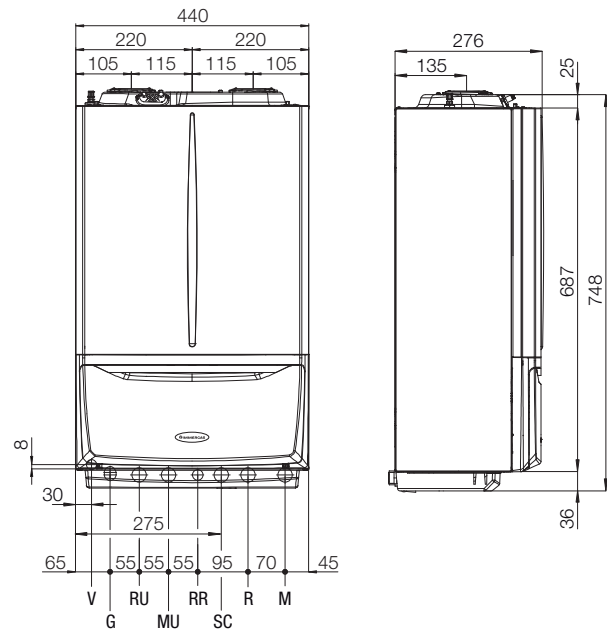

VICTRIX 28/35 TT hydraulic connections

Gas	D.H.W.		System		
	G	AC	AF	R	M
3/4"	1/2"	1/2"	3/4"	3/4"	

VICTRIX 35 X TT hydraulic connections

Gas	D.H.W.		System		
	G	RR	MU-RU*	R	M
3/4"	1/2"	3/4"	3/4"	3/4"	

* Only in case of storage tank connection kit

Key

- V Electrical connection
- G Gas supply
- AC Domestic hot water outlet
- AF Domestic cold water inlet
- RU Storage tank return (optional)
- MU Storage tank flow (optional)
- RR System filling
- SC Condensate drain (minimum internal diameter Ø 13 mm)
- ACV Solar valve domestic hot water inlet
- R System return
- M System flow
- A Outlet/Inlet
- B Inlet

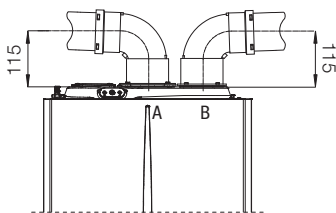

Twin pipe kit Ø 80/80

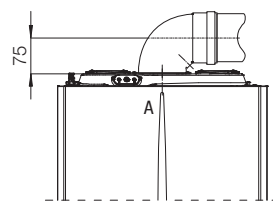

Horizontal kit Ø 60/100

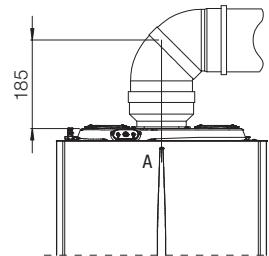

Horizontal kit Ø 80/125



CLIMATIC REGULATION

Combining the VICTRIX MAIOR TT range with a heat regulation device is an excellent investment because it improves the seasonal energy efficiency of the heating system. For each of the following heat regulation devices we therefore indicate a class, which gives you the percentage value of increased efficiency.

▾ CAR^{v2} (Modulating remote control)

Type		Code
<p>Modulating thermostat with remote boiler controls; includes special functions such as antifreeze temperature settings and anti-legionnaire function (only for boilers with DHW storage tank)</p> <p>Product class V* or I Seasonal energy efficiency value 3%* or 1%</p>	 <p>Dimensions (H x W x D) mm 103 x 142 x 31</p>	3.021395

▾ CAR^{v2} WIRELESS (Modulating remote control)

<p>New-generation wireless modulating thermostat with remote boiler controls; includes special functions such as antifreeze temperature settings and anti-legionnaire function (only for boilers with DHW storage tank)</p> <p>Product class V* or I Seasonal energy efficiency value 3%* or 1%</p>	 <p>Dimensions (H x W x D) mm 103 x 142 x 31</p> <p>Dimensions (H x W x D) mm 82 x 105 x 26</p>	3.021623
---	---	----------

▾ MINI CRD (Mini Digital Remote Control)

<p>Compact modulating thermostat</p> <p>Note: it can be installed only for single zone systems and without an external probe or DOMINUS interface board kit</p> <p>Product class V Seasonal energy efficiency value 3%</p>	 <p>Dimensions (H x W x D) mm 80 x 80 x 23</p>	3.020167
--	---	----------

▾ CRONO 7

<p>Weekly digital chronothermostat</p> <p>Product class I* o IV Seasonal energy efficiency value 1%* o 2%</p>	 <p>Dimensions (H x W x D) mm 103 x 142 x 31</p>	3.021622
---	---	----------

▾ CRONO 7 WIRELESS

<p>Wireless weekly digital chronothermostat</p> <p>Product class I* o IV Seasonal energy efficiency value 1%* o 2%</p>	 <p>Dimensions (H x W x D) mm 103 x 142 x 31</p> <p>Dimensions (H x W x D) mm 82 x 105 x 26</p>	3.021624
--	---	----------

▾ EXTERNAL PROBE

<p>Allows at the boiler to functioning at a variable temperature according to the climatic conditions</p> <p>Product class II* Seasonal energy efficiency value 2%*</p>		3.014083
---	--	----------

* Product class with default settings. Some heat regulation device can change class depending on the settings and operation modes that can be changed, for example Modulating or ON/OFF, The use of these devices contributes, in percentage, to the seasonal energy efficiency of the heating system.

TELEPHONIC CONTROL

Type		Code
For buildings equipped with telephone network. Available for all models except Mini CRD		Dimensions (H x W x D) mm 85 x 85 x 31 3.013305

GSM TELEPHONIC CONTROL

For buildings not equipped with telephone network. Available for all models except Mini CRD		Dimensions (H x W x D) mm 198 x 78 x 30,5 3.017182
--	---	--

RELAY BOARD KIT

Allows interface between zone valves and CAR, to send an alarm signal, to manage external pump etc.		3.015350
---	--	----------

CONTROL BOX

Control box for pumps and zone (maximum three)		3.011668
---	--	----------

SAFETY THERMOSTAT KIT

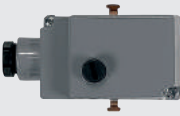
For low temperature system delivery		3.019229
-------------------------------------	--	----------

DOMINUS INTERFACE BOARD KIT **PREVIEW**

To remote control boiler with DOMINUS APP (Available by december 2015)		3.026273
---	--	----------



OPTIONAL

Inside the various range of options it is possible to find out complementary accessories for installing VICTRIX MAIOR TT. The use of original kits enhances quality and reliability of the products.

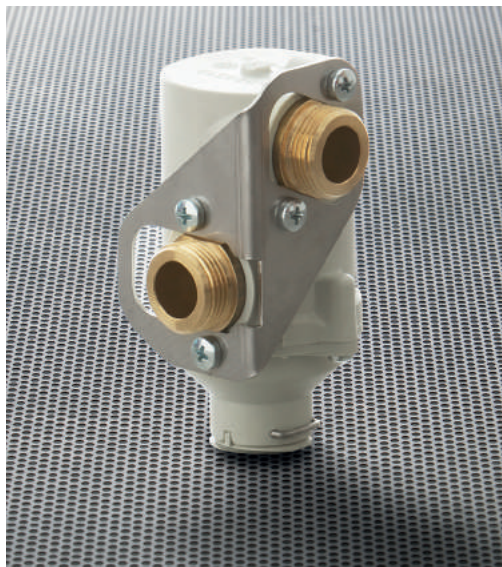

Magnetic cyclone filter kit

(code 3.024176)



Important in case of boiler replacement in order to restrain possible ferrous.

It connects the so called “cyclonic effect” (impurities removal through a circular motion of water) to the magnetic one. This is possible thanks to a rod containing permanent magnets located in central position that hold ferrous particles flowing on the water. Easy to inspect and clean, since the system emptying is not needed. Only for indoor installation.

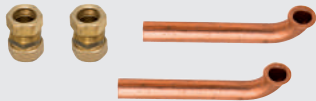
STORAGE TANK CONNECTION KIT

Type		Code
2 pipes and hydraulic fittings		3.024609

SHUT OFF KNOBS

Shut off knobs 3/4"		3.5324
Shut off knobs with filters		3.015854

ALL PURPOSE CONNECTION KIT

For wall hung boiler		3.011667
----------------------	--	----------

ANTISCALE KIT

Type		Code
For combi boiler only. Approved for installation inside the building		3.017323

NON RETURN VALVE KIT

For combi boiler only		3.016301
-----------------------	--	----------

ADDITIONAL EXPANSION VESSEL

2 litre expansion vessel		3.017514
--------------------------	---	----------

CONDENSATE DISCHARGE PUMP KIT **PREVIEW**

Usefull in case of counterslope between siphone and discharge; installation externaly to the boiler (Available by december 2015)		3.026374
---	--	----------

ANTI-FREEZE PROTECTION KIT

Until -15 °C		3.017324
--------------	--	----------

COVER KIT

For external installations, in partially protected places		3.024608
---	--	----------

VICTRIX MAIOR TT can be connected to the DIM Range (Multysystem distribution manifolds).



Follow us **Immergas Italia**



immergas.com



Immergas S.p.A.
42041 Brescello (RE) - Italy
T. 0522.689011
F. 0522.689178

	IMMERGAS IMMERGAS SPA - ITALY CERTIFIED COMPANY UNI EN ISO 9001:2008
Design, manufacture and post-sale assistance of gas boilers, gas water heaters and related accessories	

