

USERS
MAGIS

Instructions and warnings **IE**

1.046979ENG



MAGIS M4-30

Block heat pumps
Control Panel



Dear Customer,

Congratulations for having chosen a top-quality Immergas product, able to assure well-being and safety for a long period of time. As an Immergas customer you can also count on a Qualified Authorised After-Sales Technical Assistance Centre, prepared and updated to guarantee constant efficiency of your appliance. Read the following pages carefully: you will be able to draw useful tips on the proper use of the device, compliance with which will confirm your satisfaction with the Immergas product.

For assistance and routine maintenance, contact Authorised Technical Service Centres: they have original spare parts and are specifically trained directly by the manufacturer.

General warnings

All Immergas products are protected with suitable transport packaging.

The material must be stored in a dry place protected from the weather.

The instruction booklet is an integral and essential part of the product and must be given to the new user in the case of transfer or succession of ownership.

It must be stored with care and consulted carefully, as all of the warnings provide important safety indications for installation, use and maintenance stages.

This instruction manual provides technical information for installing the Immergas pack. As for the other issues related to pack installation (e.g. safety in the work site, environment protection, injury prevention), it is necessary to comply with the provisions specified in the regulations in force and good practice rules.

In compliance with legislation in force, the systems must be designed by qualified professionals, within the dimensional limits established by the Law. Installation and maintenance must be performed in compliance with the regulations in force, according to the manufacturer's instructions and by professionally qualified staff, intended as staff with specific technical skills in the system sector, as envisioned by the Law.

Improper installation or assembly of the Immergas appliance and/or components, accessories, kits and devices can cause unexpected problems for people, animals and objects. Read the instructions provided with the product carefully to ensure proper installation.

Maintenance must be carried out by skilled technical staff. The Authorised After-Sales Service represents a guarantee in terms of qualifications and professionalism.

The appliance must only be destined for the use for which it has been expressly declared. Any other use will be considered improper and therefore potentially dangerous.

If errors occur during installation, operation and maintenance, due to non-compliance with technical laws in force, standards or instructions contained in this book (or however supplied by the manufacturer), the manufacturer is excluded from any contractual and extra-contractual liability for any damage and the appliance warranty is invalidated.

The company **IMMERGAS S.p.A.**, with registered office in via Cisa Ligure 95 42041 Brescello (RE), declares that the design, manufacturing and after-sales assistance processes comply with the requirements of standard **UNI EN ISO 9001:2015**.

For further details on the product CE marking, request a copy of the Declaration of Conformity from the manufacturer, specifying the appliance model and the language of the country.

The manufacturer declines all liability due to printing or transcription errors, reserving the right to make any modifications to its technical and commercial documents without forewarning.

INDEX

1	General safety warnings.	5
1.1	About the documentation.	5
1.2	For the user.	5
2	Presentation of Control panel.	6
2.1	Appearance of the Control panel.	6
2.2	Status icons.	7
3	Using home pages.	9
4	Menu structure.	12
4.1	About the menu structure.	12
4.2	Access to the menu structure.	12
4.3	How to navigate in the menu structure.	12
5	Basic use.	13
5.1	Screen unlock	13
5.2	Switching controls on/off.	14
5.3	Adjusting the temperature	17
5.4	Adjusting space operation mode.	18
6	Operation.	20
6.1	Operation mode.	20
6.2	Preset temperature.	20
6.3	Domestic Hot Water (DHW).	24
6.4	Schedule.	29
6.5	Options.	33
6.6	Child lock.	37
6.7	Service information.	39
6.8	Operation parameters.	41
6.9	For Serviceman.	43
6.10	SN VIEW	44
7	Menu structure: overview.	45

- *This manual provides a detailed explanation on the precautions to be taken during use.*
- *Read this manual carefully before using the wall-mounted control unit to guarantee its proper operation.*
- *After you have read this manual, keep it for future consultation.*

1 GENERAL SAFETY WARNINGS.

1.1 ABOUT THE DOCUMENTATION.

- The precautions described in this document cover very important topics. Follow them carefully

DANGER

Indicates a situation that could result in serious injury or death.

DANGER: RISK OF ELECTROCUTION

Indicates a situation that could result in electrocution.

DANGER: RISK OF BURNING

Indicates a situation that could result in burns because of extreme hot or cold temperatures.

WARNING

Indicates a situation that could result in serious injury or death.

CAUTION

Indicates a situation that could result in minor or moderate injury.

NOTE

Indicates a situation that could result in equipment or property damage.

INFORMATION

Indicates useful tips or additional information.

1.2 FOR THE USER.

- If you are not sure how to operate the unit, contact your installer.
- This appliance must not be used by persons (including children) without adequate physical, sensory or mental capacities or without specific experience and knowledge, unless they are supervised or have been instructed as to how to use the appliance by a person responsible for their safety. Supervise children and make sure they do not play with the device.

CAUTION

Do NOT wash the unit as this could result in electrocution or fire.

- The devices are marked with the following symbol:



This symbol indicates that electric and electronic products must not be disposed of together with household unsorted waste. Do NOT try to disassemble the system on your own: only a qualified installer may disassemble the device and process the refrigerant, oil and other components, in compliance with standards in force. The units must be processed at a specific waste disposal facility so that the materials can be reused, recycled and recovered. Making sure that the product is disposed of correctly shall avoid possible negative consequences for the environment and human health. For further information, contact your installer or local authorities.

- Install in a place where there is no radiation present.

2 PRESENTATION OF CONTROL PANEL.

2.1 APPEARANCE OF THE CONTROL PANEL.

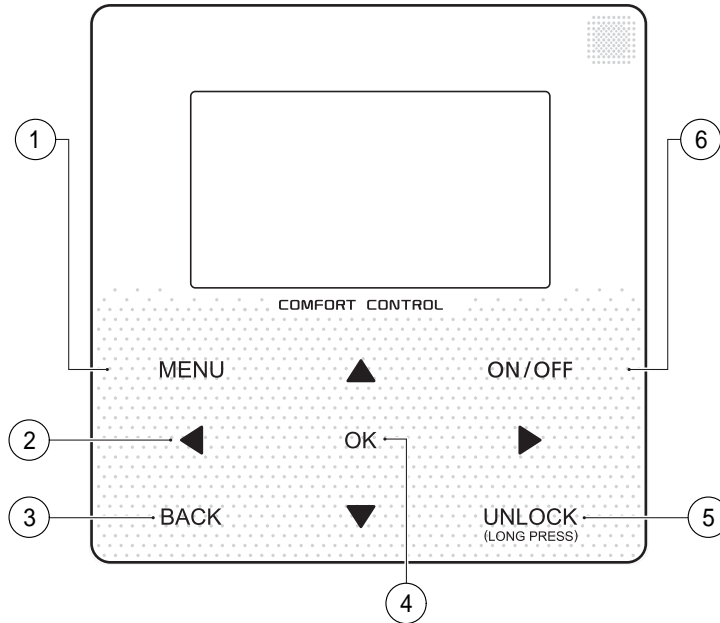

Reference	Icon	Function
1	MENU	Enter the menu structure from the home page.
2		Move the cursor on the display. Navigate in the menu structure. Adjust the settings.
3	BACK	Go back to higher level.
4	OK	Go to the next step when programming a schedule in the menu structure. Confirm a selection. Enter a submenu in the menu structure.
5	UNLOCK (LONG PRESS)	Long press to unlock/lock the control panel.
6	ON/OFF	Enable or disable the space operation mode or DHW mode. Enable or disable the function in the menu structure.

2.2 STATUS ICONS.

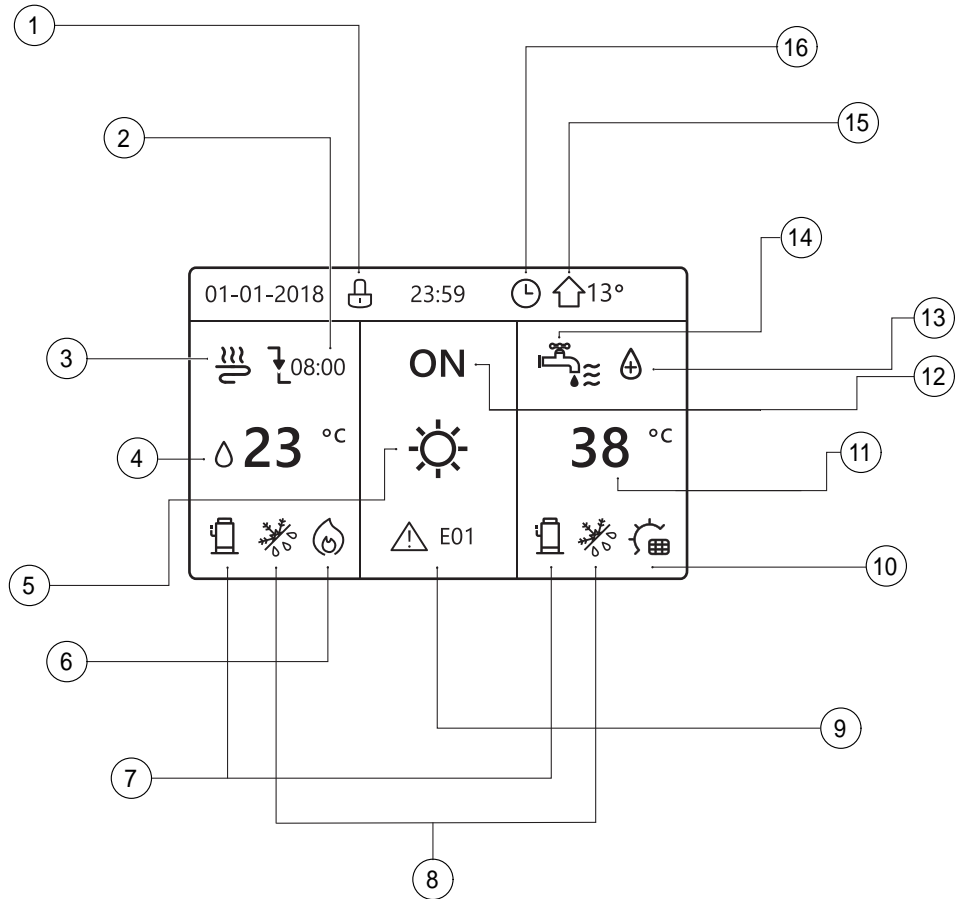

Reference	Icon	Description	
1		Lock icon	
2		Desired temperature does not change	At the next scheduled action, the desired temperature will decrease
		Desired temperature decreases	
		Desired temperature increases	
3		Fan coil on	
		Radiator on	
		Floor heating on	
4	23 °C	Desired water flow temperature	
	23,5 °C	Desired room temperature	
5		Heat mode	
		Cool mode	
		Auto mode	
6		Additional heating source	
		Electric pipe heating source	
7		Compressor on	

Reference	Icon	Description	
8		Anti-freeze mode activated	
		Defrost mode activated	
		Holiday away / home activated	
		Silent mode activated	
		ECO mode activated	
9		Error or protection icon	
		Pump I on	
			Smart grid
			Free electricity
			Peak end electricity
10		Peak electricity	
		Additional heating source	
		Solar energy activated	
11	38 °C	Tank heater on	
12	OFF ON	Domestic hot water tank temperature	
13		Turn Off / On	
14		Disinfect function activated	
15		Domestic hot water	
16		External room temperature	
		Weekly schedule icon	
		Timer Icon	

	Fan coil	Radiator	Floor heating	Domestic hot water
ON				
OFF				

3 USING HOME PAGES.

When the control panel is switched on, the language selection page is displayed. Choose the desired language and then press OK to view the home pages. If you do not press OK within 60 seconds, the system will set the currently selected language:



The home pages can be used to read and adjust settings intended for daily use. The settings displayed and that can be set on the home pages are described in the relative sections. The following home pages can be displayed depending on the system layout:

- Desired room temperature (ROOM);
- Desired water flow temperature (MAIN);
- Actual domestic hot water tank temperature (TANK).

Home page 1.

If WATER FLOW TEMP. is set at YES and ROOM TEMP. is set at NO (see “FOR SERVICEMAN” > “TEMP. TYPE SETTING” in the Use and Installation Booklet”), the system will also include the floor heating and domestic hot water function. Home page 1 will appear:

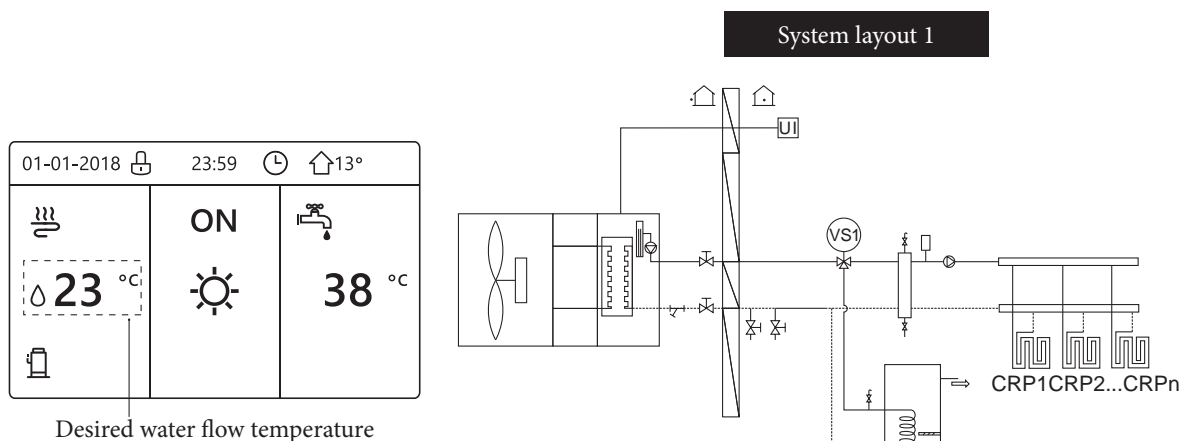

NOTE:

All the images in the manual have been inserted for illustrative purposes. Therefore there could be differences compared to the pages that actually appear on the screen.

Home page 2.

If WATER FLOW TEMP. is set at NO and ROOM TEMP. is set at YES (see “FOR SERVICEMAN” > “TEMP. TYPE SETTING” in the Use and Installation Booklet”), the system will also include the floor heating and domestic hot water function. Home page 2 will appear:

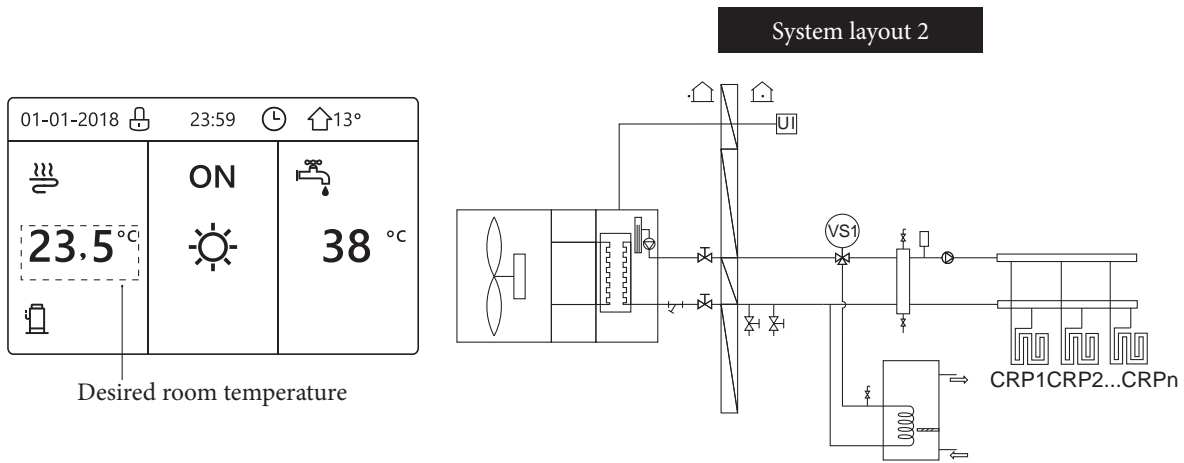

NOTE:

The wall-mounted control panel should be installed in the floor heating room to be able to control the room temperature.

Home page 3.

If DHW MODE is set at NO (see “FOR SERVICEMAN” > “DHW MODE SETTING” in Use and Installation Booklet”) and if WATER FLOW TEMP. is set at NO, ROOM TEMP. is set at YES (see “FOR SERVICEMAN” > “TEMP. TYPE SETTING” in Use and Installation Booklet”). There will be a main page and an additional page. The system also has the function including floor heating and space heating for fan coil. Home page 3 will appear:

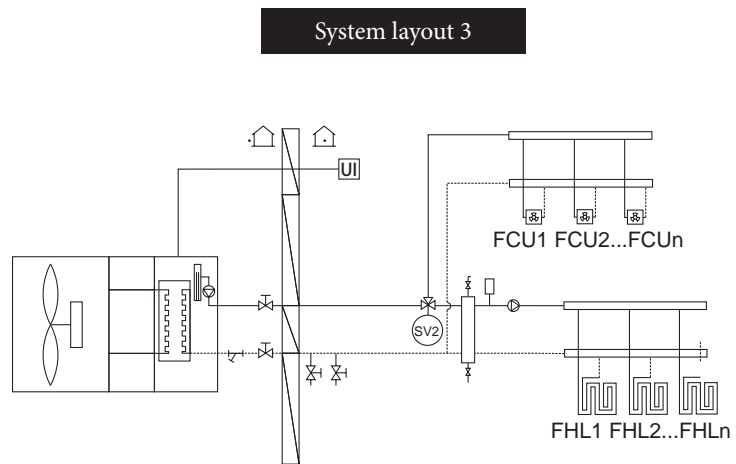
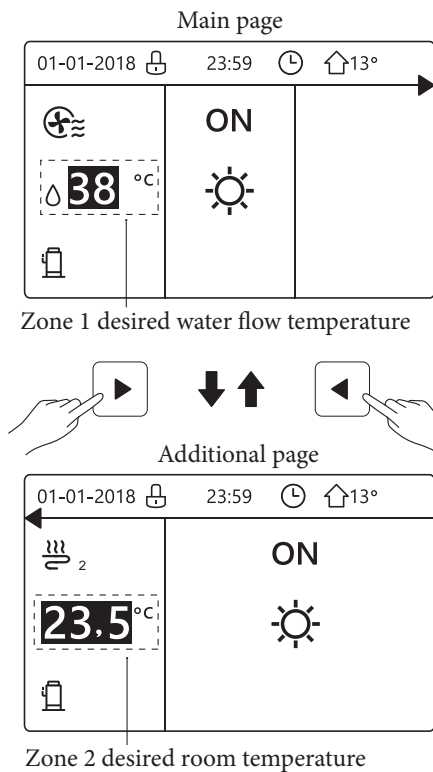

Home page 4.

If ROOM THERMOSTAT is set at DOUBLE ZONE or DOUBLE ZONE is set at YES, there will be a main page and an additional page. The system also has the function including floor heating, space heating for fan coil and domestic hot water. Home page 4 will appear:

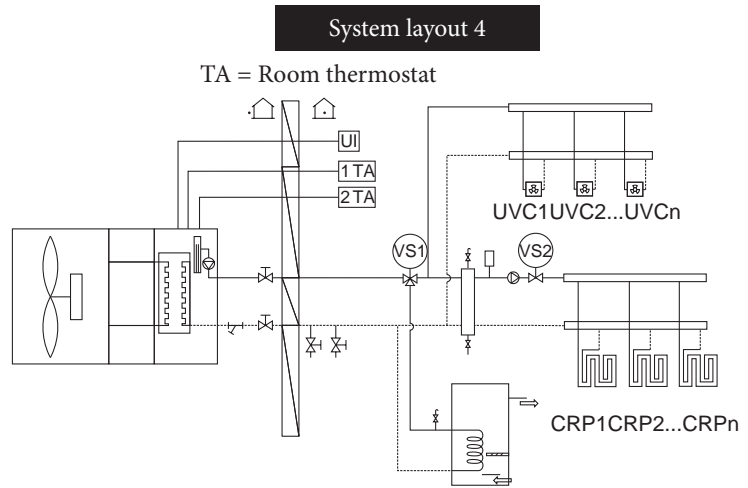
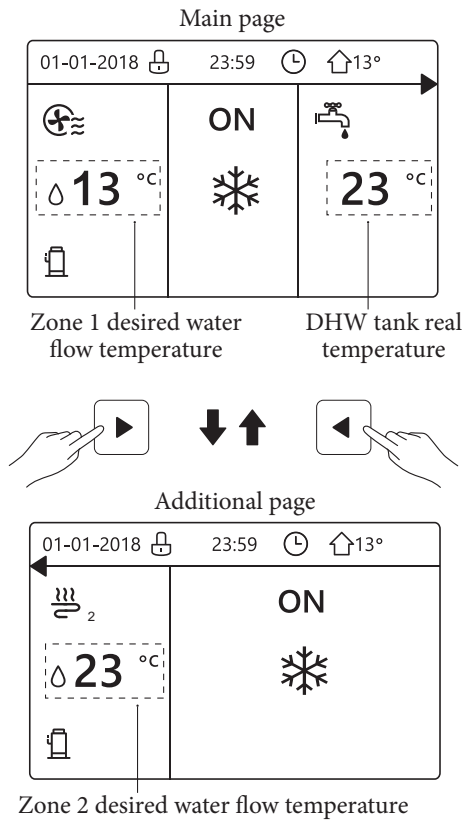

4 MENU STRUCTURE.

4.1 ABOUT THE MENU STRUCTURE.

The menu structures can be used to read and adjust settings NOT intended for daily use. The settings displayed and that can be set in the menu structures are described in the relative sections. For an overview of the menu structure, see chapter 7 “Menu structure: overview”.

4.2 ACCESS TO THE MENU STRUCTURE.

From a home page, press MENU. This will display the menu structure:

MENU	1/2
OPERATION MODE	
PRESET TEMPERATURE	
DOMESTIC HOT WATER(DHW)	
SCHEDULE	
OPTIONS	
CHILD LOCK	
OK	ENTER
⇅	

MENU	2/2
SERVICE INFORMATION	
OPERATION PARAMETER	
FOR SERVICEMAN	
WLAN SETTING	
SN VIEW	
OK	ENTER
⇅	

4.3 HOW TO NAVIGATE IN THE MENU STRUCTURE.



Use “▼” and “▲” to scroll.

5 BASIC USE.

5.1 SCREEN UNLOCK.

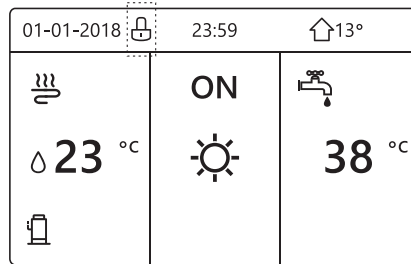
If the icon  appears on the screen, the control panel is locked. The following page is displayed:



Press any key, the icon  flashes. Press and hold the UNLOCK key. The icon  will disappear, making it possible to control the panel.

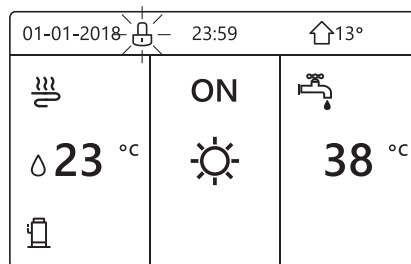

The control panel will lock if no operations are performed for much time (approximately 120 seconds): the setting can be adjusted on the panel, see paragraph 6.7 "SERVICE INFORMATION".

If the control panel is unlocked, press and hold the UNLOCK key to lock it.

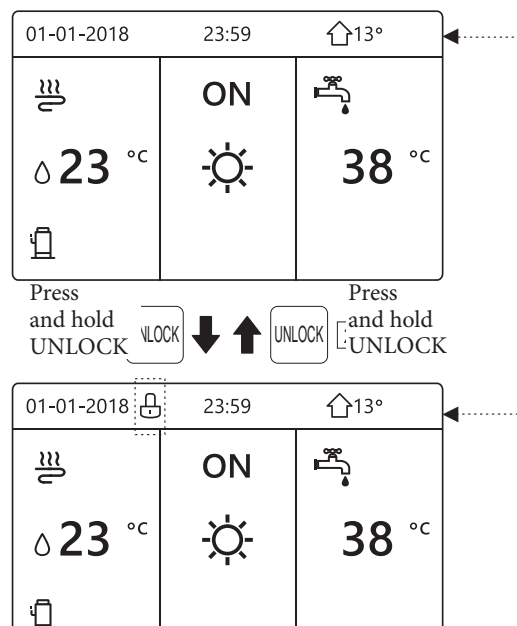

5.2 SWITCHING CONTROLS ON/OFF.

Use the control panel of the unit to switch space heating or cooling on or off.

- You may switch the unit on/off from the control panel if the ROOM THERMOSTAT is set at ON (see “ROOM THERMOSTAT SETTING” in the Use and Installation Booklet).
- Press “◀” and “▲” on the home page, the black cursor will appear:

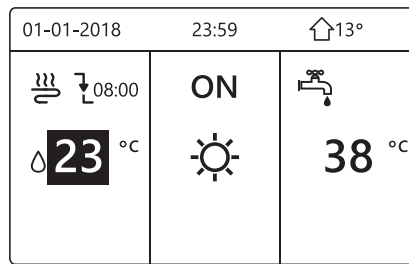

- 1) When the cursor is on the temperature on the space operation mode side (which includes Heat mode , Cool mode and Auto mode , press the ON/OFF key to activate/deactivate space heating or cooling.

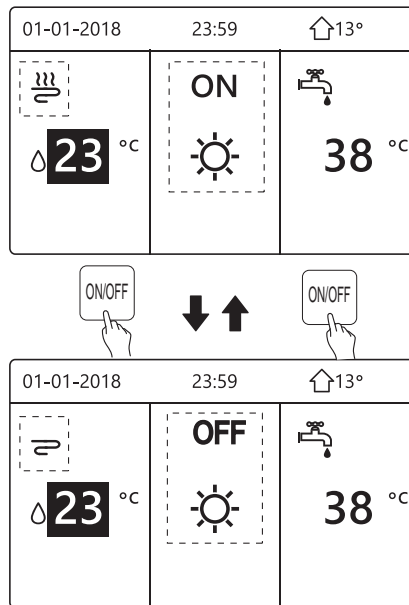

If DHW TYPE is set at NO, the following pages will appear:

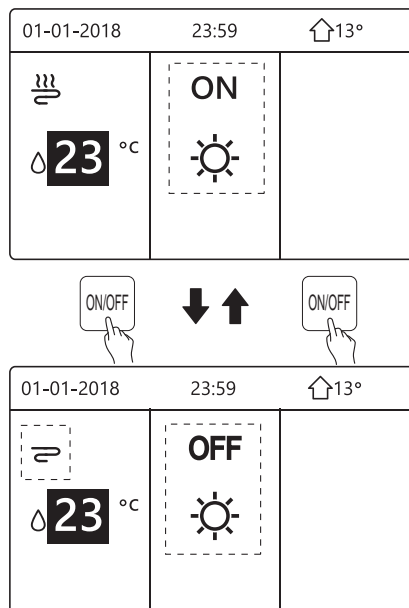

If TEMP TYPE is set at ROOM TEMP., the following pages will appear:

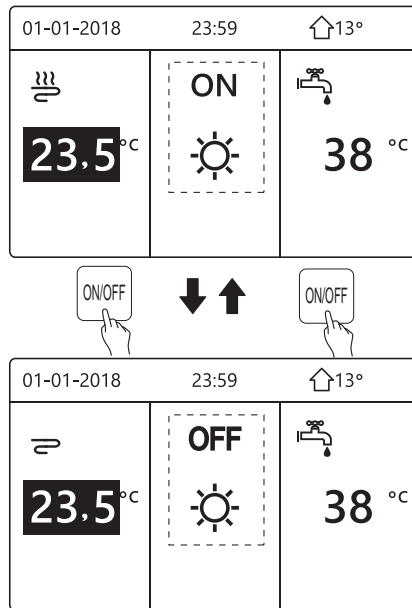

Use the room thermostat to switch space heating or cooling on or off.

- 1) The room thermostat is set at ON (see “ROOM THERMOSTAT SETTING” in the Use and Installation Booklet). The unit for space heating or cooling is activated or deactivated from the room thermostat. Press ON/OFF on the control panel, the following page will appear:

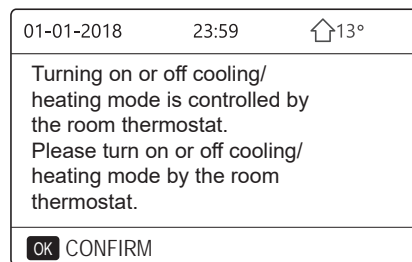

- 2) The room thermostat is set at DOUBLE ZONE (see “ROOM THERMOSTAT SETTING” in the Use and Installation Booklet). The room thermostat for the fan coil is off, the room thermostat for floor heating is on and the unit is running, but the display is off. The following page appears:

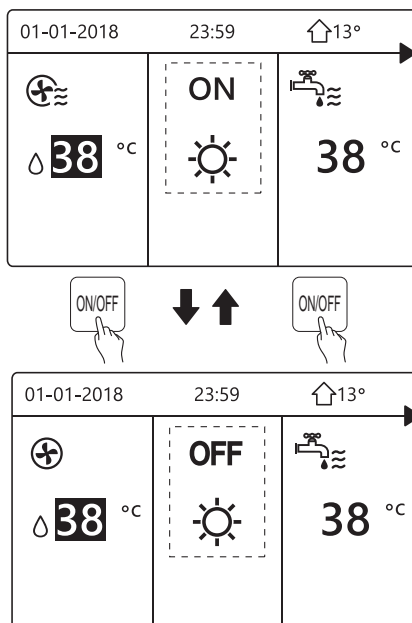

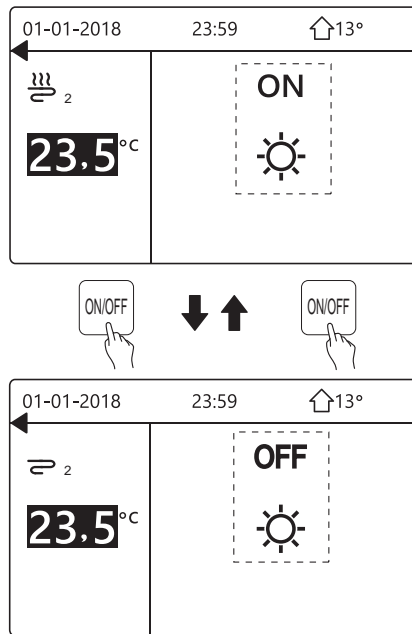

Use the control panel to switch the DHW unit on or off. Press “▶” and “▼” on the home page, the black cursor will appear:

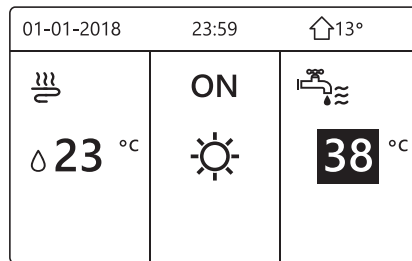

- 2) When the cursor is on the temperature of the DHW mode, press the “ON/OFF” key to activate or deactivate it. If the space operation mode is activated (ON), the following pages appear:

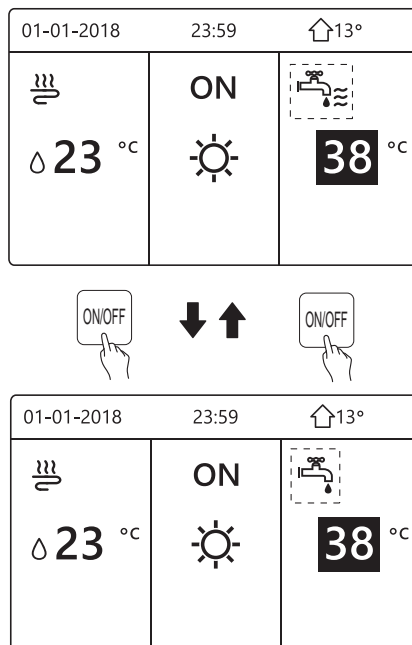

If the space operation mode is deactivated (OFF), the following pages appear:

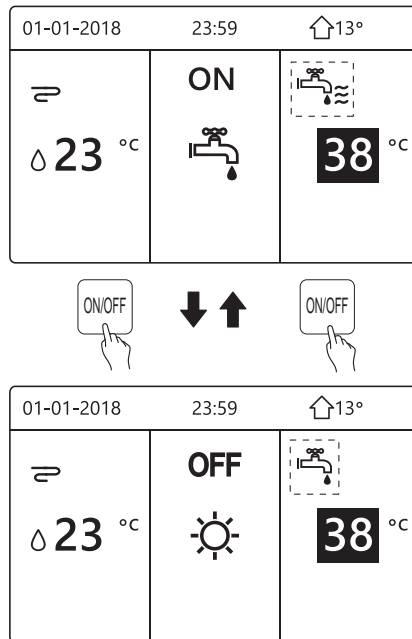

5.3 ADJUSTING THE TEMPERATURE.

Press “◀” and “▲” on the home page, the black cursor will appear:

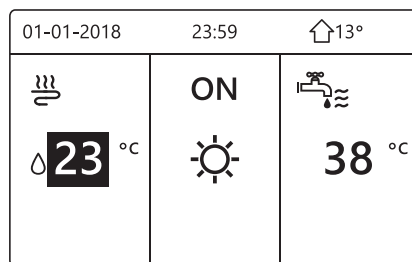

- If the cursor is on the temperature, use “◀” and “▶” to select and use “▼” and “▲” to adjust the temperature.

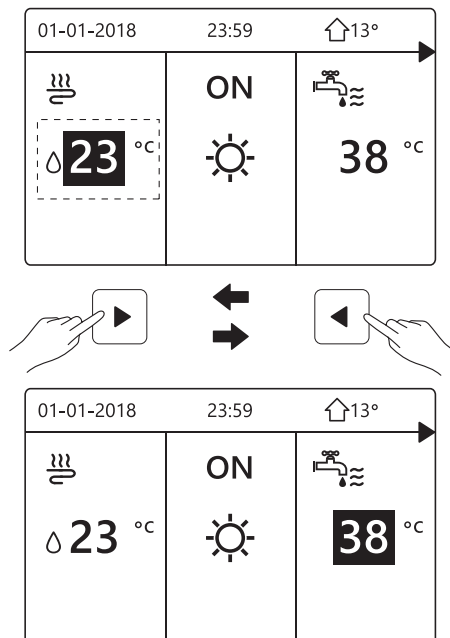

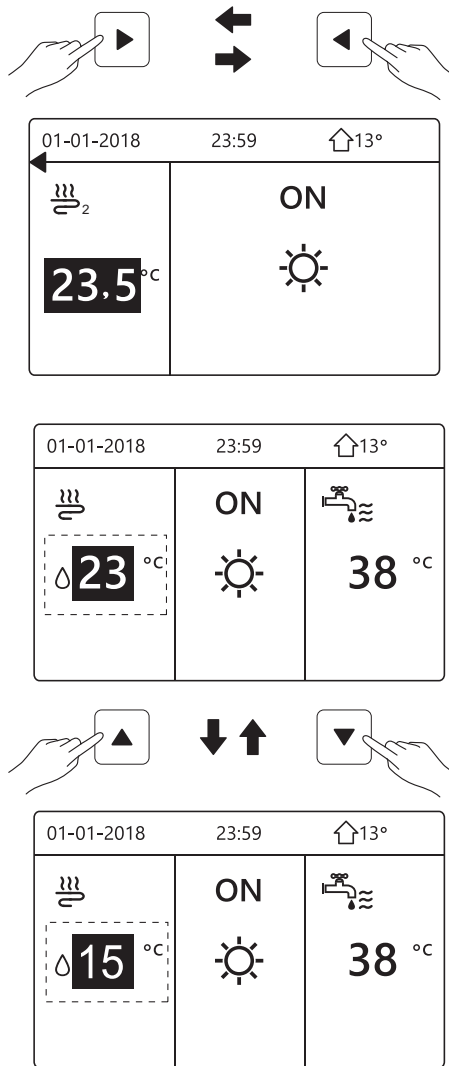

5.4 ADJUSTING SPACE OPERATION MODE.

- Adjusting space operation mode from control panel.

Go to “MENU” > “OPERATION MODE”. Press OK, the following page will appear:

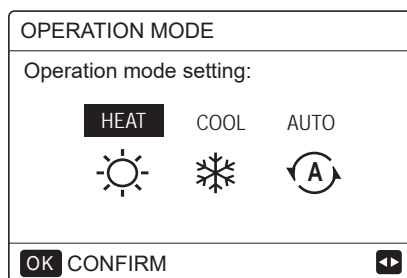

- You may select three modes, namely HEAT, COOL and AUTO. Use “◀” and “▶” to scroll, press OK to select. If you do not press OK and you exit the page by pressing BACK, the mode will remain operational if the cursor was moved to the operation mode.

If only HEAT (COOL) mode is available, the following page will appear:

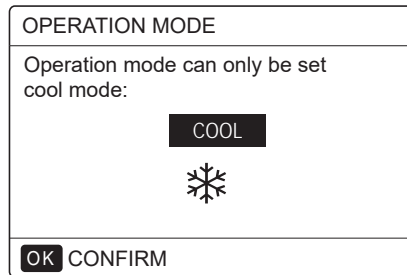
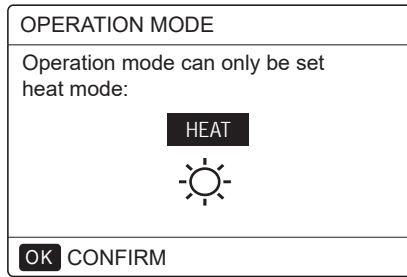

- The operation mode cannot be changed.

If you select...	Then the space operation mode is...
 HEAT	Always Heat mode
 COOL	Always Cool mode
 AUTO	Setting automatically changed by the software based on the outdoor temperature (and depending on installer settings of the outdoor temperature), and taking monthly restrictions into account. Note: the automatic change is only possible under certain conditions. See "FOR SERVICEMAN" > "AUTO MODE SETTING" in Use and Installation Booklet

- Adjust the operation mode from the room thermostat (see "ROOM THERMOSTAT" in the Use and Installation Booklet). Go to "MENU" > "OPERATION MODE". If you press any key for a selection or adjustment, the following page appears:

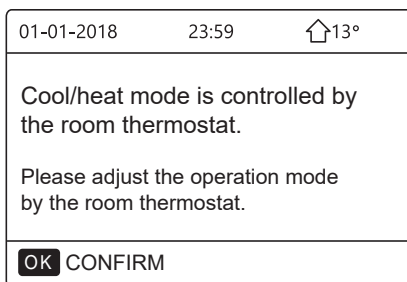

6 OPERATION.

6.1 OPERATION MODE.

See Paragraph 5.4 “Adjusting space operation mode”.

6.2 PRESET TEMPERATURE.

PRESET TEMPERATURE has 3 items:

- PRESET TEMP.;
- WEATHER TEMP. SET;
- ECO MODE.

6.2.1 PRESET TEMP.

The PRESET TEMP. function allows you to set a different temperature at a different time when Heat or Cool mode is active.

- PRESET TEMP. = PRESET TEMPERATURE
- The PRESET TEMP. function is deactivated under these conditions:
 - 1) the AUTO mode is on;
 - 2) TIMER or WEEKLY SCHEDULE are running.
- Go to “MENU” > “PRESET TEMPERATURE > PRESET TEMP. Press OK.

The following page is displayed:

PRESET TEMPERATURE			1/2
PRESET TEMP.	WEATHER TEMP.SET	ECO MODE	
NO.	TIME	TEMP.	
1	<input type="checkbox"/>	00:00	25°C
2	<input type="checkbox"/>	00:00	25°C
3	<input type="checkbox"/>	00:00	25°C
			⬆ ⬇ ⬅

PRESET TEMPERATURE			2/2
PRESET TEMP.	WEATHER TEMP.SET	ECO MODE	
NO.	TIME	TEMP.	
4	<input type="checkbox"/>	00:00	25°C
5	<input type="checkbox"/>	00:00	25°C
6	<input type="checkbox"/>	00:00	25°C
			⬆ ⬇ ⬅

When the DOUBLE ZONE function is activated, PRESET TEMP. is only active for zone 1.

Use “◀”, “▶”, “▼”, “▲” to scroll and use “▼” and “▲” to adjust the time and the temperature.

When the cursor is on “■”, as in the following page;

PRESET TEMPERATURE			1/2
PRESET TEMP.	WEATHER TEMP.SET	ECO MODE	
NO.	TIME	TEMP.	
1	<input checked="" type="checkbox"/>	00:00	25°C
2	<input type="checkbox"/>	00:00	25°C
3	<input type="checkbox"/>	00:00	25°C
OK <input checked="" type="checkbox"/> SELECT			⬆ ⬇ ⬅

Press “OK” and “■” becomes “▼”. Timer 1 is selected. Press “OK” again and “▼” becomes “■”. Timer 1 is unselected.

PRESET TEMPERATURE			1/2
PRESET TEMP.	WEATHER TEMP.SET	ECO MODE	
NO.	TIME	TEMP.	
1	<input type="checkbox"/> 08:00	35°C	
2	<input type="checkbox"/> 12:00	25°C	
3	<input checked="" type="checkbox"/> 15:00	35°C	
OK <input type="checkbox"/> CANCEL			

Use “◀”, “▶”, “▼”, “▲” to scroll and use “▼” and “▲” to adjust the time and temperature. Six periods and six temperatures can be set.

For example: now it is 8:00 and the temperature is 30°C. We set the PRESET TEMP. as in the table below. The following page is displayed:

01-01-2018		8:00	↑13°
		08:00	ON
	25 °C		

NO.	TIME	TEMPER.
1	8:00	35°C
2	12:00	25°C
3	15:00	35°C
4	18:00	25°C
5	20:00	35°C
6	23:00	25°C

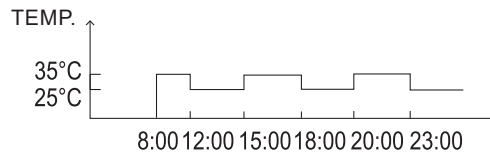

i INFORMATION

When the space operation mode is changed, PRESET TEMP. automatically switches off.

The PRESET TEMP. function can be used in Heat mode or Cool mode. However if the operation mode is changed, the PRESET TEMP. function needs to be restored.

The current preset temperature is not valid when the unit is OFF. When the unit is switched back on, it will run at the next preset temperature.

6.2.2 WEATHER TEMP. SET

- WEATHER TEMP. SET = WEATHER TEMPERATURE SET
- The WEATHER TEMP. SET function allows you to preset the desired water flow temperature based on the outdoor air temperature. When the weather heats up, heating is turned down. Therefore to save energy, the desired water flow temperature is reduced when the outdoor temperature increases and the Heat mode is active.

Go to “MENU” > “PRESET TEMPERATURE > WEATHER TEMP. SET”. Press OK.
The following page is displayed:

PRESET TEMPERATURE		
PRESET TEMP.	WEATHER TEMP.SET	ECO MODE
ZONE1 C-MODE LOW TEMP.		OFF
ZONE1 H-MODE LOW TEMP.		OFF
ZONE2 C-MODE LOW TEMP.		OFF
ZONE2 H-MODE LOW TEMP.		OFF
ON/OFF ON/OFF		⬇

i INFORMATION

- WEATHER TEMP. SET has four types of curves:
 - 1) the high temperature heating setting curve;
 - 2) the low temperature heating setting curve;
 - 3) the high temperature cooling setting curve;
 - 4) the low temperature cooling setting curve.

There is only the high temperature heating setting curve if high temperature is set for central heating.

There is only the low temperature heating setting curve if low temperature is set for central heating.

There is only the high temperature cooling setting curve if high temperature is set for cooling.

There is only the low temperature cooling setting curve if low temperature is set for cooling.

- See "FOR SERVICEMAN"> "COOL MODE SETTING" and > "HEAT MODE SETTING" in Use and Installation Booklet.
- It is not possible to adjust the desired temperature (T1S), when the temperature curve is set at ON.

- To use Heat mode in zone 1, select “ZONE 1 H-MODE LOW TEMP”. To use Cool mode in zone 1, select “ZONE1 C-MODE LOW TEMP”. Selecting “ON” displays the following page:

WEATHER TEMP. SET	
WEATHER TEMP. SET TYPE:	
1	2
3	4
5	6
7	8
9	
OK CONFIRM	

Use “◀” and “▶” to scroll. Press “OK” to select.

PRESET TEMPERATURE		
PRESET TEMP.	WEATHER TEMP.SET	ECO MODE
ZONE1 C-MODE LOW TEMP.		ON
ZONE1 H-MODE LOW TEMP.		OFF
ZONE2 C-MODE LOW TEMP.		OFF
ZONE2 H-MODE LOW TEMP.		OFF
ON/OFF ON/OFF		⬇

- If the WEATHER TEMP. SET function is on, the desired temperature cannot be adjusted on the control panel. Press “▼” and “▲” to adjust the temperature on the home page. The following page is displayed:

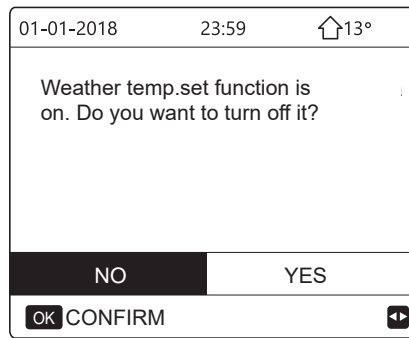

Move to “NO”, press “OK” to go back to the home page. Move to “YES”, press “OK” to restore WEATHER TEMP. SET.

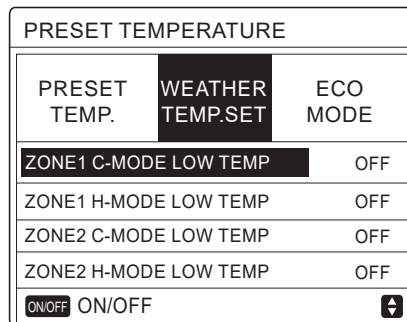

6.2.3 ECO MODE.

ECO MODE allows you to save energy. Go to “MENU” > “PRESET TEMPERATURE > ECO MODE”. Press “OK”. The following page is displayed:

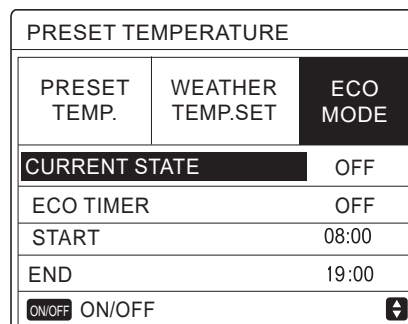

Press “ON/OFF”. The following page is displayed:

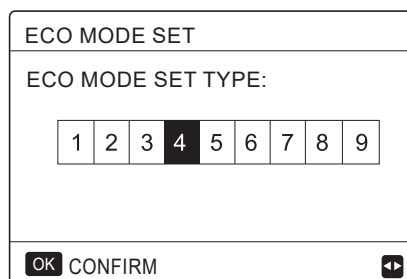

Use “◀” and “▶” to scroll. Press “OK” to select. The following page is displayed:

PRESET TEMPERATURE		
PRESET TEMP.	WEATHER TEMP.SET	ECO MODE
CURRENT STATE		ON
ECO TIMER		OFF
START		08:00
END		19:00
ON/OFF ON/OFF		⬇

Use “ON/OFF” to activate/deactivate; use “▼” and “▲” to scroll.

PRESET TEMPERATURE		
PRESET TEMP.	WEATHER TEMP.SET	ECO MODE
CURRENT STATE		OFF
ECO TIMER		ON
START		08:00
END		19:00
⬇ ADJUST		⬆

When the cursor is on “START” or “END”, you can use “◀”, “▶”, “▼”, “▲” to scroll and “▼” and “▲” to adjust the time.

i INFORMATION

- ECO MODE SET has two types of curves:
 - 1) the high temperature heating setting curve;
 - 2) the low temperature heating setting curve;

There is only the high temperature heating setting curve if high temperature is set for central heating.
There is only the low temperature heating setting curve if low temperature is set for central heating.
- See "FOR SERVICEMAN"> "HEAT MODE SETTING" in Use and Installation Booklet.
- It is not possible to adjust the desired temperature (T1S), when the ECO MODE is activated (ON).
- You may select the low or high temperature setting for heating: see “Table 1-2”.
- If ECO MODE is activated (ON) and ECO TIMER is deactivated (OFF), the unit will always work in ECO mode.
- If ECO MODE is activated (ON) and ECO TIMER is activated (ON), the unit will work in ECO mode based on the start and end time.

6.3 DOMESTIC HOT WATER (DHW).

DHW mode normally includes the following items:

- 1) DISINFECT;
- 2) FAST DHW;
- 3) TANK HEATER;
- 4) DHW PUMP.

6.3.1 Disinfect.

The DISINFECT function allows you to eliminate legionella bacteria. The tank temperature mandatorily reaches 65-70°C in the disinfect function. The disinfect temperature is set in DHW MODE. See "FOR SERVICEMAN" > "DHW MODE" > "DISINFECT" in Use and Installation Booklet.

Go to "MENU" > "DOMESTIC HOT WATER" > "DISINFECT". Press OK.
 The following page is displayed:





DOMESTIC HOT WATER (DHW)			
DIS- INFECT	FAST DHW	TANK HEATER	DHW PUMP
CURRENT STATE			ON
OPERATE DAY		FRI	
START		23:00	
ON/OFF ON/OFF 			



DOMESTIC HOT WATER (DHW)			
DIS- INFECT	FAST DHW	TANK HEATER	DHW PUMP
CURRENT STATE			OFF
OPERATE DAY		FRI	
START		23:00	
ON/OFF ON/OFF 			

Use "◀", "▶", "▼", "▲" to scroll and "▼" and "▲" to adjust the parameters to set "OPERATE DAY" and "START". If OPERATE DAY is set at FRI. and START is set at 23:00, the disinfect function will activate on Friday at 23:00.

If the disinfect function is active, the following page appears:

01-01-2018 		23:59	 13°
 23.5 °C	ON 	 38 °C	

6.3.2 FAST DHW.

The FAST DHW function forces the system to activate DHW MODE.

The heat pump and booster heater or additional heater are activated together for the DHW MODE and the desired DHW temperature goes to 60°C.

Go to “MENU” > “DOMESTIC HOT WATER” > “FAST DHW”. Press OK.

DOMESTIC HOT WATER (DHW)			
DIS-INFECT	FAST DHW	TANK HEATER	DHW PUMP
CURRENT STATE			ON
ON/OFF ON/OFF			



DOMESTIC HOT WATER (DHW)			
DIS-INFECT	FAST DHW	TANK HEATER	DHW PUMP
CURRENT STATE			OFF
ON/OFF ON/OFF			

Use the “ON/OFF” key to select activated (ON) or deactivated (OFF).

i INFORMATION

If CURRENT STATE is OFF, the FAST DHW function is not valid, while if it is ON, the FAST DHW function is activated. The FAST DHW activates once.

6.3.3 TANK HEATER.

The TANK HEATER function forces water heating in the tank. In the same situation, cooling or heating is required and the heat pump system is operating for cooling or heating. However there is a hot water demand as well.

Furthermore, if the heat pump system is not sufficient, the TANK HEATER can also be used to heat water in the tank.

Go to “MENU” > “DOMESTIC HOT WATER” > “TANK HEATER”. Press “OK”.

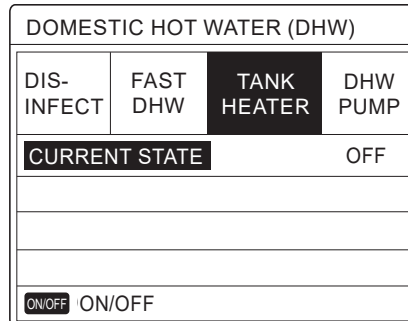
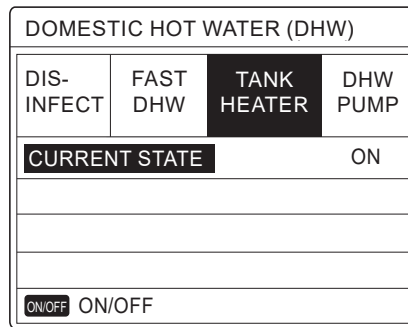

Use the “ON/OFF” key to select activated (ON) or deactivated (OFF). Use “BACK” to exit.

If TANK HEATER is on, the following page appears:

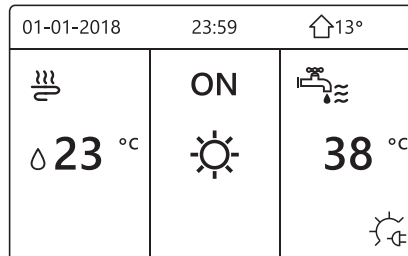

i INFORMATION

If CURRENT STATE is OFF, the TANK HEATER cannot be activated. If the tank sensor (T5) is faulty, the tank heater cannot work.

6.3.4 DHW Pump.

The DHW PUMP function makes it possible to send water back to the water mains. Go to “MENU” > “DOMESTIC HOT WATER” > “DHW PUMP”. Press “OK”. The following page is displayed:

DOMESTIC HOT WATER (DHW) 1/2			
DIS-INFECT	FAST DHW	TANK HEATER	DHW PUMP
NO.	START	NO.	START
T1 <input type="checkbox"/>	00:00	T4 <input type="checkbox"/>	00:00
T2 <input type="checkbox"/>	00:00	T5 <input type="checkbox"/>	00:00
T3 <input type="checkbox"/>	00:00	T6 <input type="checkbox"/>	00:00

DOMESTIC HOT WATER (DHW) 2/2			
DIS-INFECT	FAST DHW	TANK HEATER	DHW PUMP
NO.	START	NO.	START
T7 <input type="checkbox"/>	00:00	T10 <input type="checkbox"/>	00:00
T8 <input type="checkbox"/>	00:00	T11 <input type="checkbox"/>	00:00
T9 <input type="checkbox"/>	00:00	T12 <input type="checkbox"/>	00:00

Move to “■”, press “OK” to select or unselect (the timer is selected; the timer is not selected).

DOMESTIC HOT WATER (DHW) 1/2			
DIS-INFECT	FAST DHW	TANK HEATER	DHW PUMP
NO.	START	NO.	START
T1 <input checked="" type="checkbox"/>	00:00	T4 <input type="checkbox"/>	00:00
T2 <input type="checkbox"/>	00:00	T5 <input type="checkbox"/>	00:00
T3 <input type="checkbox"/>	00:00	T6 <input type="checkbox"/>	00:00

Use “◀”, “▶”, “▼”, “▲” to scroll and use “▼” and “▲” to adjust the parameters.

For example: the DHW PUMP parameter was set (see “FOR SERVICEMAN” > “DHW MODE SETTING” in Use and Installation Booklet. The PUMP RUNNING TIME is 30 minutes.

The setting is the following:

NO.	START
1	6:00
2	7:00
3	8:00
4	9:00

The PUMP is switched on as shown below:

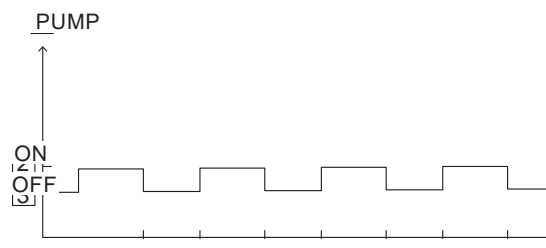



6.4 SCHEDULE.



The SCHEDULE menu contains the following items:









- 1) TIMER;
- 2) WEEKLY SCHEDULE;
- 3) SCHEDULE CHECK;
- 4) CANCEL TIMER.

6.4.1 Timer.

If the weekly schedule is on and the timer is off, the most recent setting applies. If the timer is on,  is displayed on the home page.

SCHEDULE					1/2
TIMER	WEEKLY SCHEDULE	SCHEDULE CHECK	CANCEL TIMER		
NO.	START	END	MODE	TEMP	
1	<input type="checkbox"/>	00:00	00:00	HEAT	0°C
2	<input type="checkbox"/>	00:00	00:00	HEAT	0°C
3	<input type="checkbox"/>	00:00	00:00	HEAT	0°C
					 

SCHEDULE					2/2
TIMER	WEEKLY SCHEDULE	SCHEDULE CHECK	CANCEL TIMER		
NO.	START	END	MODE	TEMP	
4	<input type="checkbox"/>	00:00	00:00	HEAT	0°C
5	<input type="checkbox"/>	00:00	00:00	HEAT	0°C
6	<input type="checkbox"/>	00:00	00:00	HEAT	0°C
					 

- Use “”, “”, “”, “” to scroll and use “” and “” to adjust the time, the mode and the temperature. Move to “”, press “OK” to select or unselect (the timer is selected; the timer is not selected). Six timers can be set. To cancel the TIMER, move the cursor on “”, and press “OK”. The icon becomes and the timer is not active. If you set the start time later than the end time (or the temperature out of range of the mode), the following page appears:

SCHEDULE			
TIMER	WEEKLY SCHEDULE	SCHEDULE CHECK	CANCEL TIMER
Timer1 is useless.			
Please check the timer setting and temperature setting.			
<input type="button" value="OK"/> CONFIRM			

Example:

Six timers are set as follows:

NO.	START	END	MODE	TEMP.
T1	1:00	3:00	DHW	50°C
T2	7:00	9:00	HEAT	28°C
T3	11:30	13:00	COOL	20°C
T4	14:00	16:00	HEAT	28°C
T5	15:00	19:00	COOL	20°C
T6	18:00	23:30	DHW	50°C

The unit is switched on as shown below:



The control panel switches on at the following times:

TIME	operation of the control panel
1:00	DHW MODE is ON
3:00	DHW MODE is OFF
7:00	HEAT MODE is ON
9:00	HEAT MODE is OFF
11:30	COOL MODE is ON
13:00	COOL MODE is OFF
14:00	HEAT MODE is ON
15:00	COOL MODE is ON and HEAT MODE is OFF
18:00	DHW MODE is ON and COOL MODE is OFF
23:30	DHW MODE is OFF

i INFORMATION

The timer is not valid if the start and end time are the same.

6.4.2 Weekly schedule.

If the timer is on and the weekly schedule is off, the most recent setting applies. If the WEEKLY SCHEDULE function is on, appears on the home page.

Go to “MENU” > “SCHEDULE” > “WEEKLY SCHEDULE”. Press “OK”. The following page is displayed:



SCHEDULE

TIMER	WEEKLY SCHEDULE	SCHEDULE CHECK	CANCEL TIMER
	MON. TUE. WED. THU. FRI. SAT. SUN.		
	<input checked="" type="checkbox"/> <input type="checkbox"/> <input type="checkbox"/> <input type="checkbox"/> <input type="checkbox"/> <input type="checkbox"/> <input type="checkbox"/>		
ENTER		CANCEL	
OK MON SELECT		<input type="button" value="↕"/> <input type="button" value="↔"/>	

First select the days of the week you wish to schedule. Use “◀” and “▶” to scroll, press OK to select or unselect the day. “**MON**” indicates that the day is selected, “MON” means that that day is unselected.



INFORMATION



At least two days must be set when activating the WEEKLY SCHEDULE function.

SCHEDULE						
TIMER	WEEKLY SCHEDULE	SCHEDULE CHECK	CANCEL TIMER			
	MON.	TUE.	WED.	THU.	FRI.	SAT. SUN.
	<input type="checkbox"/>	<input type="checkbox"/>	<input type="checkbox"/>	<input type="checkbox"/>	<input checked="" type="checkbox"/>	<input type="checkbox"/>
ENTER		CANCEL				
OK MON SELECT		 				

Use “◀” and “▶” to scroll, press OK to SET and press “ENTER”. Monday to Friday are selected and they have the same schedule.

The following pages are displayed:

SCHEDULE						1/2
TIMER	WEEKLY SCHEDULE	SCHEDULE CHECK	CANCEL TIMER			
NO.	START	END	MODE	TEMP		
1	<input type="checkbox"/>	00:00	00:00	HEAT	0°C	
2	<input type="checkbox"/>	00:00	00:00	HEAT	0°C	
3	<input type="checkbox"/>	00:00	00:00	HEAT	0°C	
						 

SCHEDULE						2/2
TIMER	WEEKLY SCHEDULE	SCHEDULE CHECK	CANCEL TIMER			
NO.	START	END	MODE	TEMP		
4	<input type="checkbox"/>	00:00	00:00	HEAT	0°C	
5	<input type="checkbox"/>	00:00	00:00	HEAT	0°C	
6	<input type="checkbox"/>	00:00	00:00	HEAT	0°C	
						 

Use “◀”, “▶”, “▼”, “▲” to scroll and adjust the time, the mode and the temperature. Several timer settings can be made, including start and end time, mode and temperature. The Heat mode, Cool mode and DHW mode are included.

The setting method refers to the timer setting. The end time must be later than the start time. Otherwise the Timer useless indication will appear, namely that it cannot be activated.

6.4.3 Schedule check.

The SCHEDULE CHECK function can only check the weekly schedule.

Go to "MENU" > "SCHEDULE" > "SCHEDULE CHECK". Press "OK". The following page is displayed:

SCHEDULE			
TIMER	WEEKLY SCHEDULE	SCHEDULE CHECK	CANCEL TIMER
WEEKLY SCHEDULE CHECK			
OK ENTER		⏪ ⏩	

WEEKLY SCHEDULE CHECK					
DAY	NO	MODE	SET	START	END
MON <input type="checkbox"/>	T1	<input type="checkbox"/>	HEAT	0°C	00:00 00:00
	T2	<input type="checkbox"/>	HEAT	0°C	00:00 00:00
	T3	<input type="checkbox"/>	HEAT	0°C	00:00 00:00
	T4	<input type="checkbox"/>	HEAT	0°C	00:00 00:00
	T5	<input type="checkbox"/>	HEAT	0°C	00:00 00:00
	T6	<input type="checkbox"/>	HEAT	0°C	00:00 00:00

Press "▼" and "▲", the Monday to Sunday timer is displayed.

6.4.4 CANCEL TIMER.

Go to "MENU" > "SCHEDULE" > "CANCEL TIMER". Press "OK". The following page is displayed:

SCHEDULE			
TIMER	WEEKLY SCHEDULE	SCHEDULE CHECK	CANCEL TIMER
Do you want to cancel the timer and weekly schedule?			
NO		YES	
OK ENTER		⏪ ⏩	

Use "◀", "▶", "▼", "▲" to move to "YES", press "OK" to cancel the timer. To exit CANCEL TIMER, press "BACK".

If the TIMER or WEEKLY SCHEDULE functions are on, the timer icon "🕒" or the weekly schedule icon "🔄" appear on the home page.

01-01-2018 📅	23:59 ⌚	🏠 13°
☁️	ON	🔧
23.5°C	☀️	38°C

If the TIMER or WEEKLY SCHEDULE is cancelled, the icon “L” or “↻” disappears from the home page.

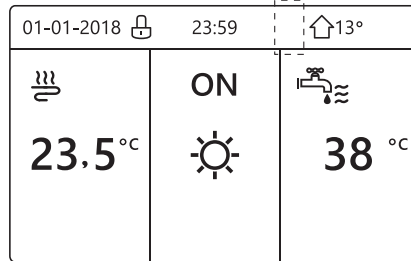

i INFORMATION

The TIMER/WEEKLY SCHEDULE must be restored if switching from the WATER FLOW TEMP. setting to ROOM TEMP. or from the ROOM TEMP. setting to WATER FLOW TEMP. TIMER or WEEKLY SCHEDULE are not valid if ROOM THERMOSTAT is on.

i INFORMATION

- ECO MODE has the highest priority. TIMER or WEEKLY SCHEDULE have an intermediate priority and PRESET TEMP. or WEATHER TEMP. SET have the lowest priority.
- PRESET TEMP. or WEATHER TEMP. SET are no longer valid when ECO mode is on. PRESET TEMP. or WEATHER TEMP. SET must be restored when ECO mode is deactivated.
- TIMER or WEEKLY SCHEDULE are not valid when ECO mode is on. TIMER or WEEKLY SCHEDULE are activated when ECO mode is not running.
- TIMER and WEEKLY SCHEDULE have the same priority. The function with the most recent setting is applied. PRESET TEMP. is no longer valid when TIMER or WEEKLY SCHEDULE are activated. TIMER or WEEKLY SCHEDULE do not affect WEATHER TEMP. SET.
- PRESET TEMP. and WEATHER TEMP. SET have the same priority. The function with the most recent setting is applied.

i INFORMATION

All items (PRESET TEMP., ECO, DISINFECT, DHW PUMP, TIMER, WEEKLY SCHEDULE, SILENT MODE, HOLIDAY HOME) can be scheduled by setting the relative function at ON/OFF from the start time to the end time.

6.5 OPTIONS.

The OPTIONS menu contains the following items:

- 1) SILENT MODE;
- 2) HOLIDAY AWAY;
- 3) HOLIDAY HOME ;
- 4) BACKUP HEATER.

6.5.1 Silent Mode.

SILENT MODE allows you reduce the noise level of the unit. However this also reduces the heating/cooling capacity of the system.

Silent mode has two levels.

Level 2 is quieter than level 1 and also has a lower heating or cooling capacity.

There are two ways to use the Silent mode:

- 1) Silent mode the whole time;
 - 2) Silent mode based on timer.
- Go to the home page to check whether Silent mode is on. Otherwise “☾” appears on the home page.

- Go to “MENU” > “OPTIONS” > “SILENT MODE”. Press “OK”. The following page is displayed:

OPTIONS				1/2
SILENT MODE	HOLIDAY AWAY	HOLIDAY HOME	BACKUP HEATER	
CURRENT STATE				OFF
SILENT LEVEL				LEVEL 1
TIMER1 START				12:00
TIMER1 END				15:00
ON/OFF				ON/OFF

Use the “ON/OFF” key to select activated (ON) or deactivated (OFF).

Description:

if CURRENT STATE is set at OFF, SILENT MODE is not valid.

When SILENT LEVEL is selected and you press “OK” or “▶”, the following page will appear:

OPTIONS				
SILENT MODE	HOLIDAY AWAY	HOLIDAY HOME	BACKUP HEATER	
CURRENT STATE				ON
SILENT LEVEL			LEVEL 1	
TIMER1 START				12:00
TIMER1 END				15:00
ADJUST				

LEVEL 1

OPTIONS				
SILENT MODE	HOLIDAY AWAY	HOLIDAY HOME	BACKUP HEATER	
CURRENT STATE				ON
SILENT LEVEL			LEVEL 2	
TIMER1 START				12:00
TIMER1 END				15:00

LEVEL 2

You can use “▼” and “▲” to select level 1 or level 2. Press “OK”.

If the silent TIMER is selected, press “OK” to enter. The following page is displayed:

OPTIONS				2/2
SILENT MODE	HOLIDAY AWAY	HOLIDAY HOME	BACKUP HEATER	
TIMER1				OFF
TIMER2 START				22:00
TIMER2 END				07:00
TIMER2				OFF

It is possible to set two timers. Move to “■”, press “OK” to select or unselect.

If both timers are unselected, the Silent mode will remain active. Otherwise operation will be time-controlled.



6.5.2 Holiday away.

- If Holiday away mode is activated,  will appear on the home page.

The Holiday away function prevents the system from freezing during winter when away on vacation and reactivates the unit before the end of holidays.

- Go to “MENU” > “OPTIONS” > “HOLIDAY AWAY”. Press “OK”. The following page is displayed:

OPTIONS		1/2
SILENT MODE	HOLIDAY AWAY	HOLIDAY HOME
CURRENT STATE		OFF
DHW MODE		ON
DISINFECT		ON
HEAT MODE		ON
ON/OFF	ON/OFF	

OPTIONS		2/2
SILENT MODE	HOLIDAY AWAY	HOLIDAY HOME
FROM	00-00-2000	
UNTIL	00-00-2000	
		
		

For example: you leave during winter. Today is 31/12/2018 and holidays start in two days (02/01/2019).

- Let's suppose that you are in this situation: in 2 days you will leave for 2 weeks during winter.
- You want to save energy but without the system freezing.

You can perform the following operations:

- 1) Configure the holiday away settings below.
- 2) Activate Holiday mode.

Go to “MENU” > “OPTIONS” > “HOLIDAY AWAY”. Press “OK”.

Use the “ON/OFF” key to select activated (ON) or deactivated (OFF) and use “◀”, “▶”, “▼”, “▲” to scroll and adjust.

Setting	Value
Holiday away	ON
From	2 January 2018
To	16 January 2018
Operation mode	Heat
Disinfect	ON

INFORMATION

- If DHW mode is on in Holiday away mode, the disinfection set by the user is not valid.
- If Holiday away mode is activated, the timer and weekly schedule are not valid unless Holiday mode is deactivated.
- If CURRENT STATE is OFF, HOLIDAY AWAY is OFF.
- If CURRENT STATE is ON, HOLIDAY AWAY is ON.
- The unit is disinfected at 23:00 on the last day, if the disinfect function is activated.
- When Holiday away mode is active, the previously set climatic curves are not valid and will automatically take effect at the end of the period set for Holiday away.
- The preset temperature is not valid when Holiday away mode is on, but the preset value still appears on the home page.

6.5.3 Holiday home.

The Holiday home function allows you to make changes to the normal schedule without needing to adjust them when spending holidays at home.

- During holidays, you may use Holiday mode to make changes to the normal schedules without needing to adjust them.

Period	Schedule
Before and after holidays	Normal schedules are activated
During holidays	The configured holiday settings are activated

If Holiday home mode is activated,  will appear on the home page.

Go to “MENU” > “OPTIONS” > “HOLIDAY HOME”. Press “OK”. The following page is displayed:

OPTIONS			
SILENT MODE	HOLIDAY AWAY	HOLIDAY HOME	BACKUP HEATER
CURRENT STATE			OFF
FROM		00-00-2000	
UNTIL		00-00-2000	
TIMER		ENTER	
ON/OFF		ON/OFF	

Use the “ON/OFF” key to select activated (ON) or deactivated (OFF) and use “◀”, “▶”, “▼”, “▲” to scroll and adjust.

If CURRENT STATE is OFF, HOLIDAY HOME is OFF.

If CURRENT STATE is ON, HOLIDAY HOME is ON.

Use “▼” and “▲” to set the date.

- The normal schedule is activated before and after holidays.
- During holidays, you save energy while keeping the system from freezing.

INFORMATION

If you change the operation mode of the unit, you must exit Holiday away or Holiday home mode.

6.5.4 Backup heater.

- The BACKUP HEATER function forces activation of the backup heater. Go to “MENU” > “OPTIONS” > “BACKUP HEATER”. Press “OK”. If IBH is set as invalid by DIP switch on the main control board of hydraulic module, the following page will appear:

OPTIONS			
SILENT MODE	HOLIDAY AWAY	HOLIDAY HOME	BACKUP HEATER

IBH = Indoor unit backup heater.

- If IBH is set as valid by DIP switch on the main control board of hydraulic module, the following page will appear:

OPTIONS			
SILENT MODE	HOLIDAY AWAY	HOLIDAY HOME	BACKUP HEATER
BACKUP HEATER			ON
ON/OFF ON/OFF			↔

Use the “ON/OFF” key to select deactivated (OFF) or activated (ON).

i INFORMATION

- If automatic operation mode is set on the space heating or cooling side, the backup heater function cannot be selected.
- The BACKUP HEATER function is not valid when only ROOM HEAT MODE is activated.

6.6 CHILD LOCK.

The CHILD LOCK function allows you to prevent children from improperly using the unit. Mode settings and temperature adjustments can be locked or unlocked by means of the CHILD LOCK function.

Go to “MENU” > “CHILD LOCK”. The following page is displayed:

CHILD LOCK	
Please input the password:	
1 2 3	
OK ENTER	ADJUST ↔

Entering the current password will display the following page:

CHILD LOCK	
COOL/HEAT TEMP. ADJUST	UNLOCK
COOL/HEAT MODE ON/OFF	UNLOCK
DHW TEMP. ADJUST	UNLOCK
DHW MODE ON/OFF	UNLOCK
UNLOCK	LOCK/UNLOCK ↕

Use “▼” and “▲” to scroll and “ON/OFF” to select LOCK or UNLOCK.

The cooling/heating temperature cannot be adjusted when the COOL/HEAT TEMP. ADJUST function is locked. If you wish to adjust the cooling/heating temperature when locked, the following page will appear:

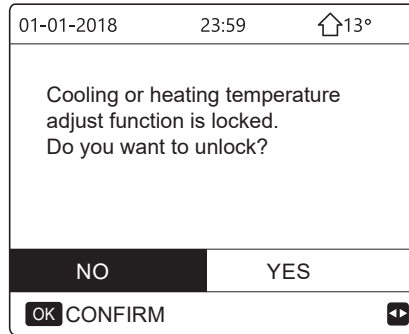

The COOL/HEAT MODE ON/OFF cannot be activated or deactivated when the function is locked. If you try to activate or deactivate COOL/HEAT MODE ON/OFF when the function is locked, the following page will appear:

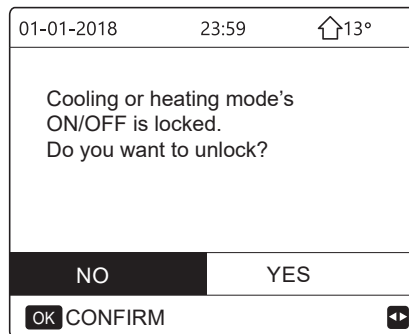

It is not possible to adjust the DHW temperature when the DHW TEMP. ADJUST function is locked. If you try to adjust the DHW temperature when the DHW TEMP. ADJUST function is locked, the following page will appear:

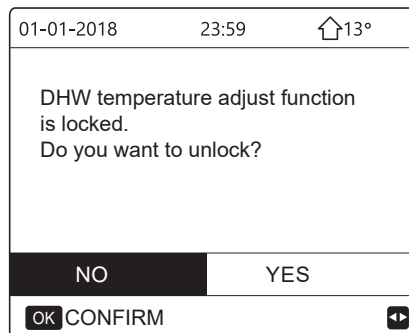

The DHW mode cannot be activated or deactivated when the DHW MODE ON/OFF function is locked. If you try to activate or deactivate the DHW mode when the DHW MODE ON/OFF function is locked, the following page will appear:

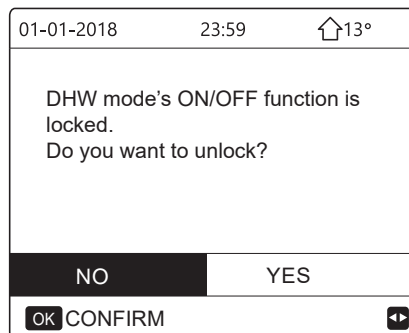

6.7 SERVICE INFORMATION.

6.7.1 Service information.

The Service information menu contains the following items:

- 1) SERVICE CALL;
- 2) ERROR CODE;
- 3) PARAMETERS;
- 4) DISPLAY.

6.7.2 How to access the service information menus.

- Go to "MENU" > "SERVICE INFORMATION". Press "OK". The following page is displayed:

The service call can contain a phone number or mobile number. The installer can enter the phone number. See "FOR SERVICEMAN".

SERVICE INFORMATION			
SERVICE CALL	ERROR CODE	PARAMETER	DISPLAY
PHONE NO. *****			
MOBILE NO. *****			
▶◀			

The error code indicates when a fault or problem occurs and shows its meaning.

SERVICE INFORMATION			
SERVICE CALL	ERROR CODE	PARAMETER	DISPLAY
E2	#00	14:10	01-01-2018
E2	#00	14:00	01-01-2018
E2	#00	13:50	01-01-2018
E2	#00	13:20	01-01-2018
OK ENTER			
▶◀			

Press "OK". The following page is displayed:

SERVICE INFORMATION			1/2
SERVICE CALL	ERROR CODE	PARAMETER	DISPLAY
E2	#00	14:10	01-01-2018
E2	#00	14:00	01-01-2018
E2	#00	13:50	01-01-2018
E2	#00	13:20	01-01-2018
OK ENTER			
▶◀			

Press “OK” to show the meaning of the error code:

01-01-2018	23:59	🏠 13°
<p>E2 communication fault between controller and indoor unit</p> <p>Please contact your dealer.</p>		
OK CONFIRM		#00

i INFORMATION

A maximum of eight error codes can be recorded.

The parameter function is used to display the main parameters. There are two parameter pages available:

SERVICE INFORMATION		1/2
SERVICE CALL	ERROR CODE	PARAMETER DISPLAY
	ROOM SET TEMP.	26°C
	MAIN SET TEMP.	55°C
	TANK SET TEMP.	55°C
	ROOM ACTUAL TEMP.	24°C

SERVICE INFORMATION		2/2
SERVICE CALL	ERROR CODE	PARAMETER DISPLAY
	MAIN ACTUAL TEMP.	26°C
	TANK ACTUAL TEMP.	55°C
	SMART GRID RUNNING TIME	0 Hrs

The DISPLAY function is used to set the control panel:

SERVICE INFORMATION			1/2
SERVICE CALL	ERROR CODE	PARAMETER	DISPLAY
TIME			12:30
DATE			08-08-2018
LANGUAGE			EN
BACKLIGHT			ON
OK ENTER			↕

SERVICE INFORMATION			2/2
SERVICE CALL	ERROR CODE	PARAMETER	DISPLAY
BUZZER			ON
SCREEN LOCK TIME			120SEC
SMART GRID RUNNING TIME			2 Hrs
ON/OFF			ON/OFF
			↕

Use “OK” to enter and “◀”, “▶”, “▼”, “▲” to scroll.

6.8 OPERATION PARAMETERS.

This manual is intended for the installer or service engineer controlling the operating parameters.

- On the home page, go to “MENU” > “OPERATION PARAMETER”.
- Press “OK”. There are six pages for the operation parameters. Use “▼” and “▲” to scroll.

OPERATION PARAMETER		#01
ONLINE UNITS NUMBER		1
OPERATE MODE		COOL
SV1 STATE		ON
SV2 STATE		OFF
SV3 STATE		OFF
PUMP_I		ON
↕ ADDRESS		1/9 ↕

OPERATION PARAMETER		#01
PUMP_O		OFF
PUMP_C		OFF
PUMP_S		OFF
PUMP_D		OFF
PIPE BACKUP HEATER		OFF
TANK BACKUP HEATER		ON
↕ ADDRESS		2/9 ↕

OPERATION PARAMETER		#01
GAS BOILER		OFF
T1 LEAVING WATER TEMP.		35°C
WATER FLOW		1.72m3/h
HEAT PUMP CAPACTIY		11.52kW
POWER CONSUM		1000kWh
Ta ROOM TEMP.		25°C
↕ ADDRESS		3/9 ↕

OPERATION PARAMETER	#01
T5 WATER TANK TEMP.	53°C
Tw2 CIRCUIT2 WATER TEMP.	35°C
TIS' C1 CLI. CURVE TEMP.	35°C
TIS2' C2 CLI. CURVE TEMP.	35°C
TW_O PLATE W-OUTLET TEMP.	35°C
TW_I PLATE W-INLET TEMP.	30°C
◀ ADDRESS	4/9 ▶

OPERATION PARAMETER	#01
Tbt1 BUFFERTANK_UP TEMP.	35°C
Tbt2 BUFFERTANK_LOW TEMP.	35°C
IDU SOFTWARE	01-09-2019V01
◀ ADDRESS	5/9 ▶

OPERATION PARAMETER	#01
ODU MODEL	6kW
COMP.CURRENT	12A
COMP.FREQUENCY	24Hz
COMP.RUN TIME	54 MIN
COMP.TOTAL RUN TIME	1000Hrs
EXPANSION VALVE	200P
◀ ADDRESS	6/9 ▶

OPERATION PARAMETER	#01
FAN SPEED	600R/MIN
IDU TARGET FREQUENCY	46Hz
FREQUENCY LIMITED TYPE	5
SUPPLY VOLTAGE	230V
DC GENERATRIX VOLTAGE	420V
DC GENERATRIX CURRENT	18A
◀ ADDRESS	7/9 ▶

OPERATION PARAMETER	#01
TW_O PLATE W-OUTLET TEMP.	35°C
TW_I PLATE W-INLET TEMP.	30°C
T2 PLATE F-OUT TEMP.	35°C
T2B PLATE F-IN TEMP.	35°C
Th COMP. SUCTION TEMP.	5°C
Tp COMP. DISCHARGE TEMP.	75°C
◀ ADDRESS	8/9 ▶

OPERATION PARAMETER	#01
T3 OUTDOOR EXCHANGE TEMP.	5°C
T4 OUTDOOR AIR TEMP.	5°C
TF MODULE TEMP.	55°C
P1 COMP. PRESSURE	2300kPa
ODU SOFTWARE	01-09-2018V01
HMI SOFTWARE	01-09-2018V01
◀ ADDRESS	9/9 ▶

i INFORMATION

Entering the power consumption parameter is optional.
Parameters not activated in the system are marked "--".
The heat pump capacity is only indicated as a reference and must not be used to assess the efficiency of the unit.
Sensor accuracy is $\pm 1^{\circ}\text{C}$.
The flow rate parameters are calculated based on the operation parameters of the pump.
The deviation changes depending on the flow rates.
The maximum deviation is 15%.

6.9 FOR SERVICEMAN.

6.9.1 Information on For serviceman menu.

The FOR SERVICEMAN menu is intended for the installer and service engineer.

- Setting the functions of the appliance.
- Setting the parameters.

6.9.2 How to access the For serviceman menu.

Go to "MENU" > "FOR SERVICEMAN". Press "OK".

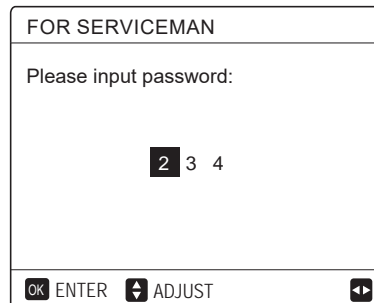

FOR SERVICEMAN

Please input password:

2 3 4

OK ENTER ADJUST

- The FOR SERVICEMAN menu is intended for the installer and service engineer. Domestic users must NOT modify the settings through this menu.
- This is why it is protected by password to prevent unauthorised persons from having access to the service settings.
- The password is 234.

6.9.3 How to exit the FOR SERVICEMAN menu.

If all the parameters have been set, press "BACK". The following page is displayed:

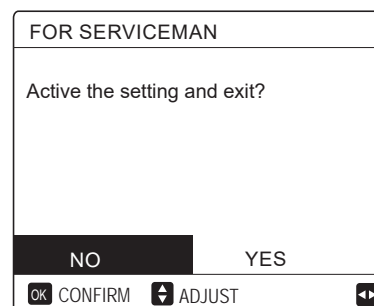

FOR SERVICEMAN

Active the setting and exit?

NO YES

OK CONFIRM ADJUST

Select "YES" and press "OK" to exit the FOR SERVICEMAN menu.
After you have exited the menu, the unit shuts down.

6.10 SN VIEW

SN VIEW	
HMI NO.	0000C3111000H120F19A264001320000
	

SN VIEW	#1
IDU NO.	341140003929C26010005Z
ODU NO.	31125300Y1286280400029
	

7 MENU STRUCTURE: OVERVIEW.

MAIN MENU		
OPERATION MODE	HEAT	
	COOL	
	AUTO	
PRESET TEMPERATURE	PRESET TEMP.	
	WEATHER TEMP. SET	
	ECO MODE	
DOMESTIC HOT WATER(DHW)	DISINFECT	CURRENT STATE OPERATE DAY START
	FAST DHW	
	TANK HEATER	
	DHW PUMP	
SCHEDULE	TIMER	
	WEEKLY SCHEDULE	
	SCHEDULE CHECK	
	CANCEL TIMER	
OPTIONS	SILENT MODE	CURRENT STATE
		SILENT LEVEL
		TIMER 1 START
		TIMER 1 END
	HOLIDAY AWAY	CURRENT STATE
		DHW MODE
		DISINFECT
		HEAT MODE
		FROM
	UNTIL	
HOLIDAY HOME	CURRENT STATE	
	FROM	
	UNTIL	
BACKUP HEATER	TIMER	
CHILD LOCK	COOL/HEAT TEMP. ADJUST	
	COOL/HEAT MODE ON/OFF	
	DHW TEMP. ADJUST	
	DHW MODE ON/OFF	
SERVICE INFORMATION	SERVICE CALL	
	ERROR CODE	
	PARAMETER	
	DISPLAY	TIME
		DATE
		LANGUAGE
		BACKLIGHT
		BUZZER
SCREEN LOCK TIME		
SMART GRID RUNNING TIME		

MAIN MENU		
OPERATION PARAMETER	OPERATION PARAMETER	
FOR SERVICEMAN	1 DHW MODE SETTING	
	2 COOL MODE SETTING	
	3 HEAT MODE SETTING	
	4 AUTO MODE SETTING	
	5 TEMP. TYPE SETTING	
	6 ROOM THERMOSTAT	
	7 OTHER HEATING SOURCE	
	8 HOLIDAY AWAY SETTING	
	9 SERVICE CALL	
	10 RESTORE FACTORY SETTINGS	
	11 TEST RUN	
	12 SPECIAL FUNCTION	
	13 AUTO RESTART	
	14 POWER INPUT LIMITATION	
	15 INPUT DEFINE	
	16 CASCADE SET	
	17 HMI ADDRESS SET	
WLAN SETTING*	WLAN SETTING	AP MODE
		RESTORE WLAN SETTING
SN VIEW	SN VIEW	HMI
		IDU
		ODU

(*) = Application not available.

For Serviceman Menu Overview.

FOR SERVICEMAN	
1 DHW MODE SETTING	1.1 DHW MODE
	1.2 DISINFECT
	1.3 DHW PRIORITY
	1.4 DHW PUMP
	1.5 DHW PRIORITY TIME SET
	1.6 dT5_ON
	1.7 dT1S5
	1.8 T4DHWMAX
	1.9 T4DHWMIN
	1.10 t_INTERVAL_DHW
	1.11 dT5_TBH_OFF
	1.12 T4_TBH_ON
	1.13 t_TBH_DELAY
	1.14 T5S_DI
	1.15 t_DI_HIGHTEMP
	1.16 t_DI_MAX
	1.17 t_DHWHP_RESTRICT
	1.18 t_DHWHP_MAX
	1.19 DHW PUMP TIME RUN
	1.20 PUMP RUNNING TIME
	1.21 DHW PUMP DI RUN

FOR SERVICEMAN	
2 COOL MODE SETTING	2.1 COOL MODE
	2.2 t_T4_FRESH_C
	2.3 T4CMAX
	2.4 T4CMIN
	2.5 dT1SC
	2.6 dTSC
	2.7 t_INTERVAL_C
	2.8 T1SetC1
	2.9 T1SetC2
	2.10 T4C1
	2.11 T4C2
	2.12 ZONE1 C-EMISSION
	2.13 ZONE2 C-EMISSION

FOR SERVICEMAN	
3 HEAT MODE SETTING	3.1 HEAT MODE
	3.2 t_T4_FRESH_H
	3.3 T4HMAX
	3.4 T4HMIN
	3.5 dT1SH
	3.6 dTSH
	3.7 t_INTERVAL_H
	3.8 T1SetH1
	3.9 T1SetH2
	3.10 T4H1
	3.11 T4H2
	3.12 ZONE1 H-EMISSION
	3.13 ZONE2 H-EMISSION
	3.14 t_DELAY_PUMP

FOR SERVICEMAN	
4 AUTO MODE SETTING	4.1 T4AUTOCMIN
	4.2 T4AUTOHMAX

FOR SERVICEMAN	
5 TEMP. TYPE SETTING	5.1 WATER FLOW TEMP.
	5.2 ROOM TEMP.
	5.3 DOUBLE ZONE

FOR SERVICEMAN	
6 ROOM THERMOSTAT	6.1 ROOM THERMOSTAT

FOR SERVICEMAN	
7 OTHER HEATING SOURCE	7.1 dT1_IBH_ON
	7.2 t_IBH_DELAY
	7.3 T4_IBH_ON
	7.4 dT1_AHS_ON
	7.5 t_AHS_DELAY
	7.6 T4_AHS_ON
	7.7 IBH LOCATE
	7.8 P_IBH1
	7.9 P_IBH2
	7.10 P_TBH

FOR SERVICEMAN	
8 HOLIDAY AWAY SETTING	8.1 T1S_H.A._H
	8.2 T5S_H.A._DHW

FOR SERVICEMAN	
9 SERVICE CALL	PHONE NO.
	MOBILE NO.

FOR SERVICEMAN	
10 RESTORE FACTORY SETTINGS	

FOR SERVICEMAN	
11 TEST RUN	

FOR SERVICEMAN	
12 SPECIAL FUNCTION	

FOR SERVICEMAN	
13 AUTO RESTART	13.1 COOL/HEAT MODE
	13.2 DHW MODE

FOR SERVICEMAN	
14 POWER INPUT LIMITATION	14.1 POWER LIMITATION

FOR SERVICEMAN	
15 INPUT DEFINE	15.1 ON/OFF(M1M2)
	15.2 SMART GRID
	15.3 T1B(Tw2)
	15.4 Tbt1
	15.5 Tbt2
	15.6 Ta
	15.7 Ta-adj
	15.8 SOLAR INPUT
	15.9 F-PIPE LENGTH
	15.10 RT/Ta_PCB
	15.11 PUMPI SILENT MODE
	15.12 DFT1/DFT2

FOR SERVICEMAN	
16 CASCADE SET	16.1 PER_START
	16.2 TIME_ADJUST
	16.3 ADDRESS RESET

FOR SERVICEMAN																				
17 HMI ADDRESS SET											17.1 HMI SET									
											17.2 HMI ADDRESS FOR BMS									
											17.3 STOP BIT									

Table 1

The room temperature curve of the low temperature setting for heating.

T4	≤-20	-19	-18	-17	-16	-15	-14	-13	-12	-11	-10	-9	-8	-7	-6	-5	-4	-3	-2	-1	0
1-T1S	38	38	38	38	38	37	37	37	37	37	37	36	36	36	36	36	36	35	35	35	35
2-T1S	37	37	37	37	37	36	36	36	36	36	36	35	35	35	35	35	35	34	34	34	34
3-T1S	36	36	36	35	35	35	35	35	35	34	34	34	34	34	34	33	33	33	33	33	33
4-T1S	35	35	35	34	34	34	34	34	34	33	33	33	33	33	33	32	32	32	32	32	32
5-T1S	34	34	34	33	33	33	33	33	33	32	32	32	32	32	32	31	31	31	31	31	31
6-T1S	32	32	32	32	31	31	31	31	31	31	31	31	30	30	30	30	30	30	30	30	29
7-T1S	31	31	31	31	30	30	30	30	30	30	30	30	29	29	29	29	29	29	29	29	28
8-T1S	29	29	29	29	28	28	28	28	28	28	28	28	27	27	27	27	27	27	27	27	26
T4	1	2	3	4	5	6	7	8	9	10	11	12	13	14	15	16	17	18	19	≥	20
1-T1S	35	35	34	34	34	34	34	34	33	33	33	33	33	33	32	32	32	32	32	32	32
2-T1S	34	34	33	33	33	33	33	33	32	32	32	32	32	32	31	31	31	31	31	31	31
3-T1S	32	32	32	32	32	32	31	31	31	31	31	31	30	30	30	30	30	30	29	29	29
4-T1S	31	31	31	31	31	31	30	30	30	30	30	30	29	29	29	29	29	29	28	28	28
5-T1S	30	30	30	30	30	30	29	29	29	29	29	29	28	28	28	28	28	28	27	27	27
6-T1S	29	29	29	29	29	29	28	28	28	28	28	28	27	27	27	27	27	27	26	26	26
7-T1S	28	28	28	28	28	28	27	27	27	27	27	27	26	26	26	26	26	26	25	25	25
8-T1S	26	26	26	26	26	26	26	25	25	25	25	25	25	25	25	24	24	24	24	24	24

Table 2

The room temperature curve of the high temperature setting for heating.

T4	≤-20	-19	-18	-17	-16	-15	-14	-13	-12	-11	-10	-9	-8	-7	-6	-5	-4	-3	-2	-1	0
1-T1S	55	55	55	55	54	54	54	54	54	54	54	54	53	53	53	53	53	53	53	53	52
2-T1S	53	53	53	53	52	52	52	52	52	52	52	52	51	51	51	51	51	51	51	51	50
3-T1S	52	52	52	52	51	51	51	51	51	51	51	51	50	50	50	50	50	50	50	50	49
4-T1S	50	50	50	50	49	49	49	49	49	49	49	49	48	48	48	48	48	48	48	48	47
5-T1S	48	48	48	48	47	47	47	47	47	47	47	47	46	46	46	46	46	46	46	46	45
6-T1S	45	45	45	45	44	44	44	44	44	44	44	44	43	43	43	43	43	43	43	43	42
7-T1S	43	43	43	43	42	42	42	42	42	42	42	42	41	41	41	41	41	41	41	41	40
8-T1S	40	40	40	40	39	39	39	39	39	39	39	39	38	38	38	38	38	38	38	38	37
T4	1	2	3	4	5	6	7	8	9	10	11	12	13	14	15	16	17	18	19	≥	20
1-T1S	52	52	52	52	52	52	52	51	51	51	51	51	51	51	51	50	50	50	50	50	50
2-T1S	50	50	50	50	50	50	50	49	49	49	49	49	49	49	49	48	48	48	48	48	48
3-T1S	49	49	49	49	49	49	49	48	48	48	48	48	48	48	48	47	47	47	47	47	47
4-T1S	47	47	47	47	47	47	47	46	46	46	46	46	46	46	46	45	45	45	45	45	45
5-T1S	45	45	45	45	45	45	45	44	44	44	44	44	44	44	44	43	43	43	43	43	43
6-T1S	42	42	42	42	42	42	42	41	41	41	41	41	41	41	41	40	40	40	40	40	40
7-T1S	40	40	40	40	40	40	40	39	39	39	39	39	39	39	39	38	38	38	38	38	38
8-T1S	37	37	37	37	37	37	37	36	36	36	36	36	36	36	36	35	35	35	35	35	35

Automatic setting curve.

The automatic setting curve is the ninth; it is calculated as follows:

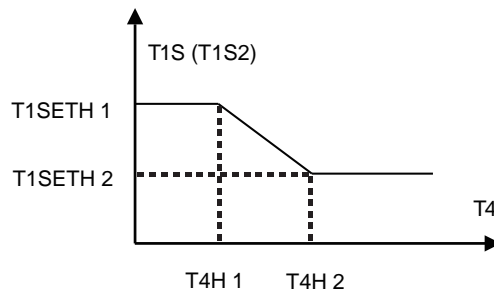

State: in the setting of the control panel, if $T4H2 < T4H1$, exchange their value; if $T1SETH1 < T1SETH2$, exchange their value

Table 3

The room temperature curve of the low temperature setting for cooling.

T4	$-10 \leq T4 \leq 15$	$15 \leq T4 \leq 22$	$22 \leq T4 \leq 30$	$30 \leq T4$
1-T1S	16	11	8	5
2-T1S	17	12	9	6
3-T1S	18	13	10	7
4-T1S	19	14	11	8
5-T1S	20	15	12	9
6-T1S	21	16	13	10
7-T1S	22	17	14	11
8-T1S	23	18	15	12

Table 4

The room temperature curve of the high temperature setting for cooling.

T4	$-10 \leq T4 \leq 15$	$15 \leq T4 \leq 22$	$22 \leq T4 \leq 30$	$30 \leq T4$
1-T1S	20	18	17	16
2-T1S	21	19	18	17
3-T1S	22	20	19	17
4-T1S	23	21	19	18
5-T1S	24	21	20	18
6-T1S	24	22	20	19
7-T1S	25	22	21	29
8-T1S	25	23	21	20

Automatic setting curve.

The automatic setting curve is the ninth; it is calculated as follows:

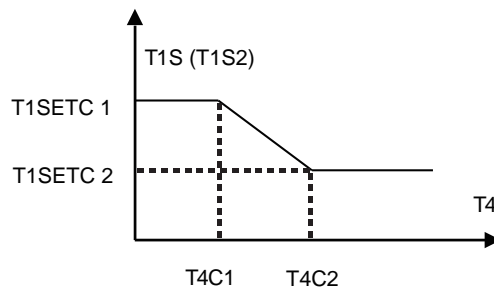

State: in the setting of the control panel, if $T4C2 < T4C1$, exchange their value; if $T1SETC1 < T1SETC2$, exchange their value



This instruction booklet
is made of ecological paper



immergas.com

Immergas S.p.A.
42041 Brescello (RE) - Italy
Tel. 0522.689011
Fax 0522.680617

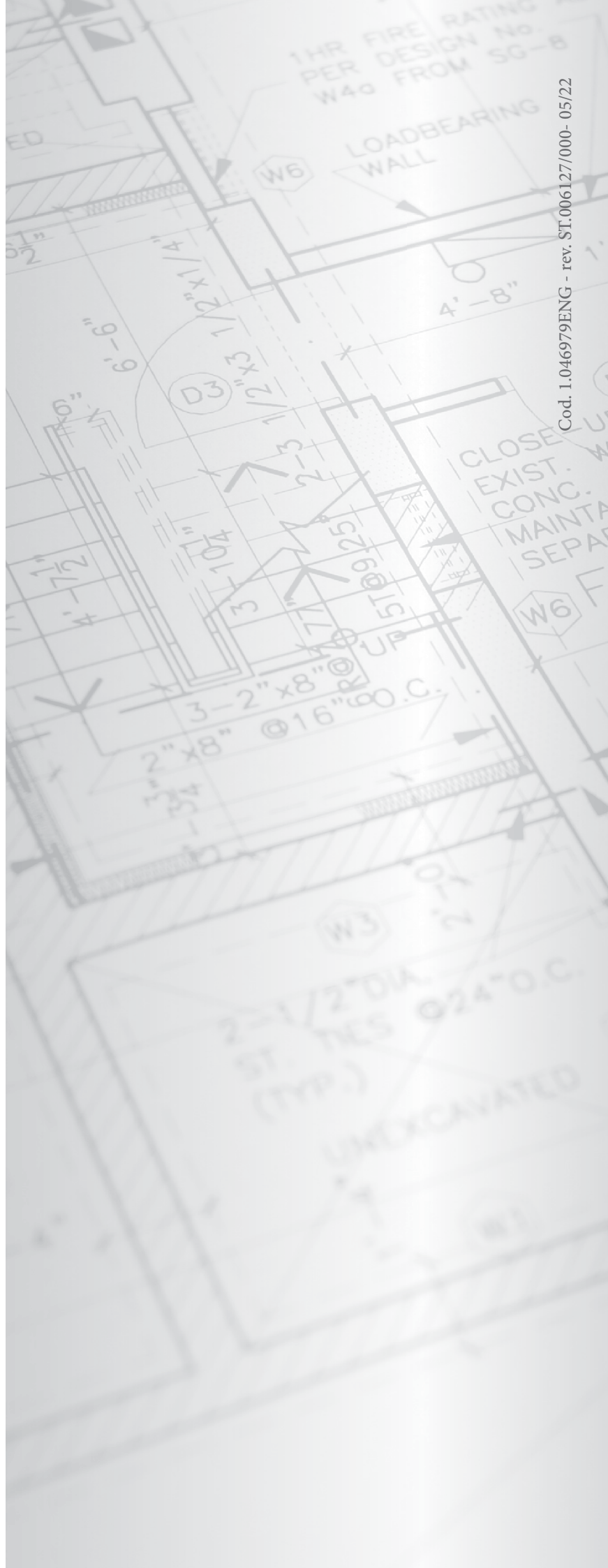

Cod. 1.046979ENG - rev. ST.006127/000-05/22