

THK CHUO

Precision Stage Series

Fix Stages

NEW



Don't move!
Sit still!

The position locks after adjustment,
with no clamp required.

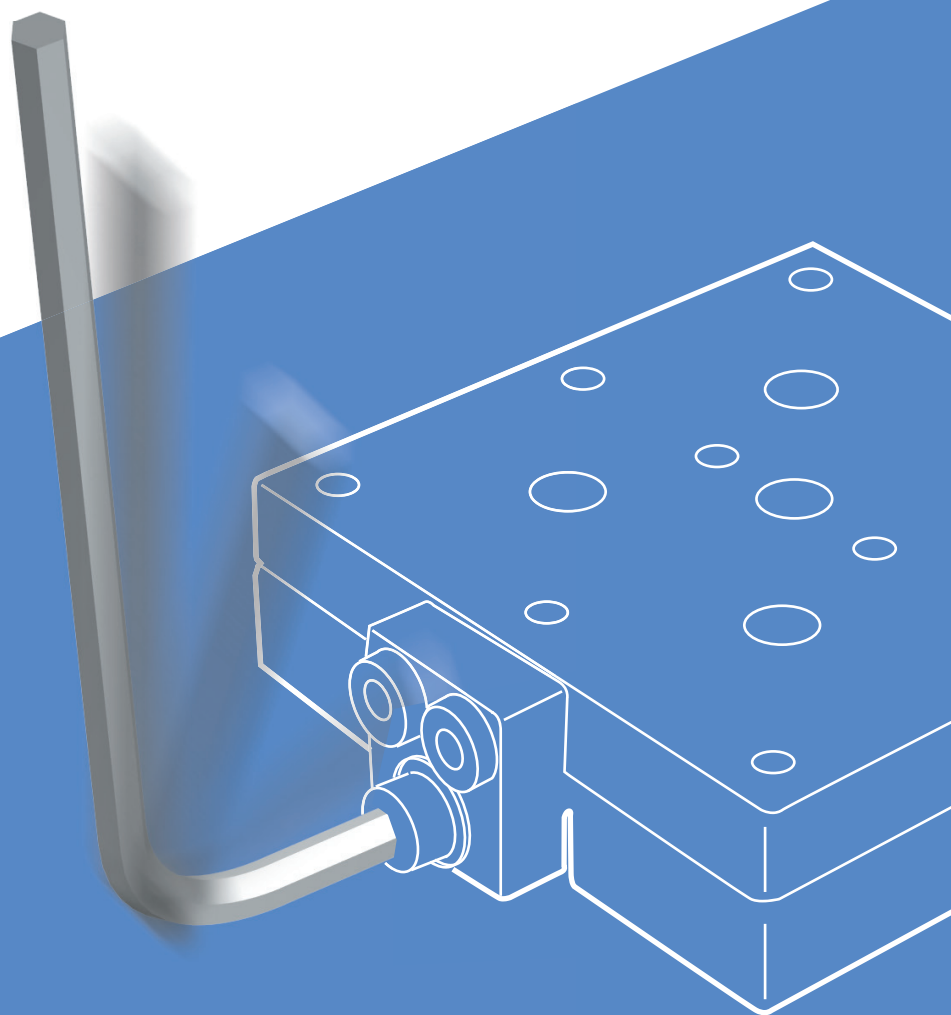

Having trouble with manual stages?

Manual Stages

Example 1

After adjusting the position, the stage ends up moving when the clamp is used.



Example 2

The stage ends up moving because of forgetting to use the clamp.

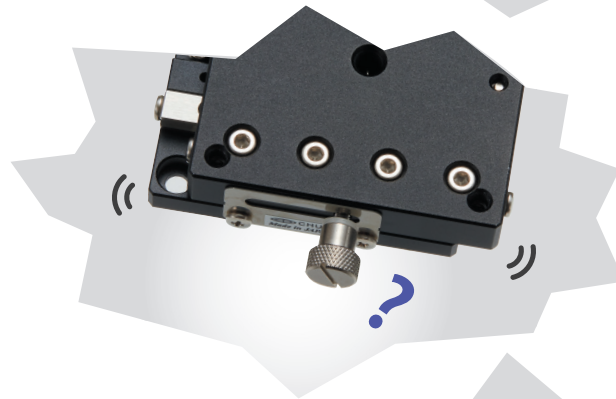

Example 3

The stage ends up moving because the clamp comes loose.

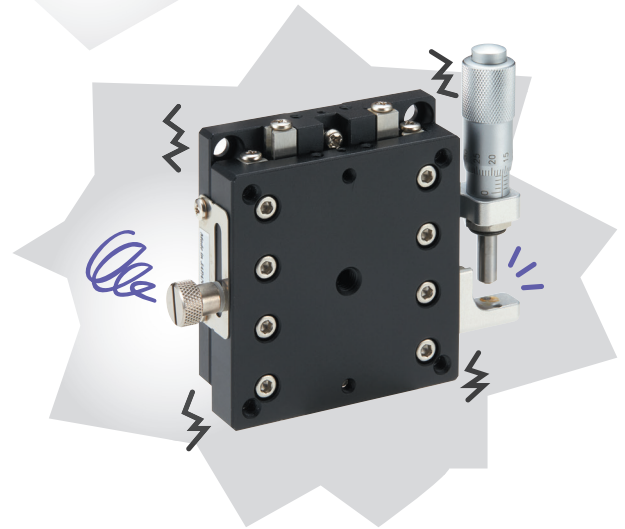

Fix Stages are perfect for tasks such as:

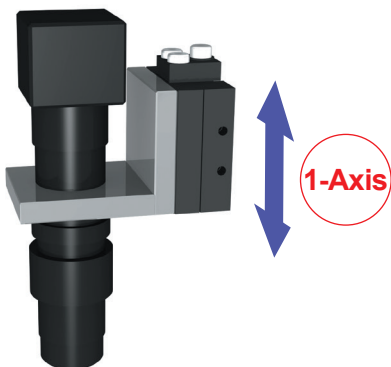

Adjusting camera AF positions

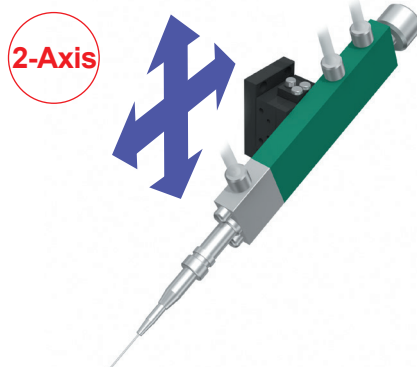

Positioning dispensers

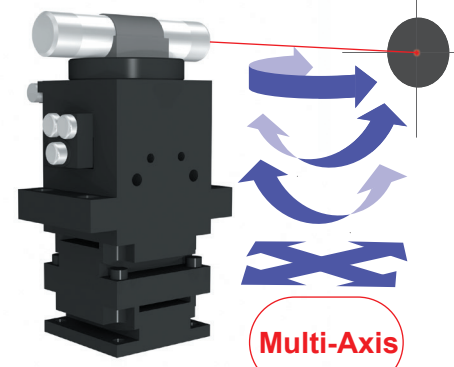

Adjusting laser focal points

The Fix Stage is the solution!



After adjusting the position, the stage doesn't move even though it doesn't have a clamp!

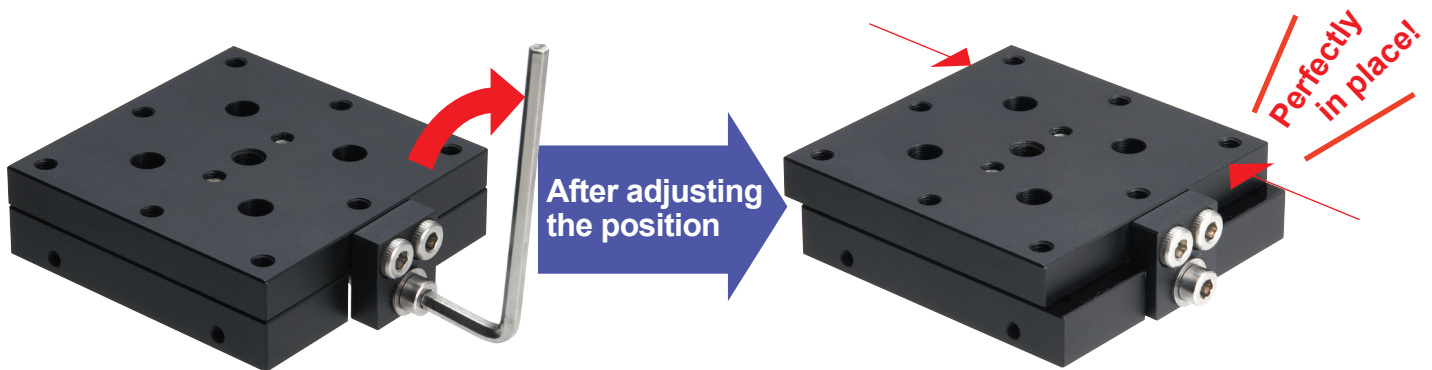

- Once the stage has been moved and its position has been adjusted, it can immediately be fixed in place, and there is no need to use a clamp.
- Thanks to a uniquely developed special mechanism, the stage doesn't move after the position has been adjusted.

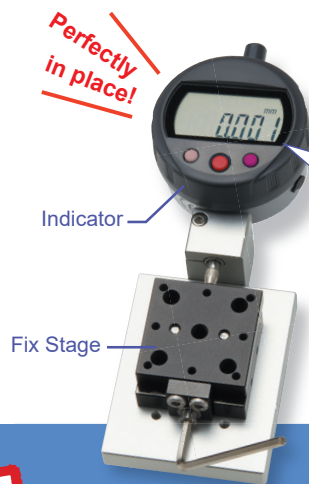

After the position has been adjusted, no movement can be seen on the indicator scale even when the face of the stage is grabbed and forcefully shaken.

改善 KAIZEN

- ✓ Reduced position adjustment times (increased productivity)
- ✓ Long-term maintenance of position precision (improved quality)

Lineup of X Axis, XY Axis, Thin Type X Axis, Thin Type XY Axis, Z Lift, Goniometer, 2-Axis Goniometer, Rotary, Tilt, and Transmission Type in various sizes.

*The dimensions shown are of the upper face of the stage (width × depth).

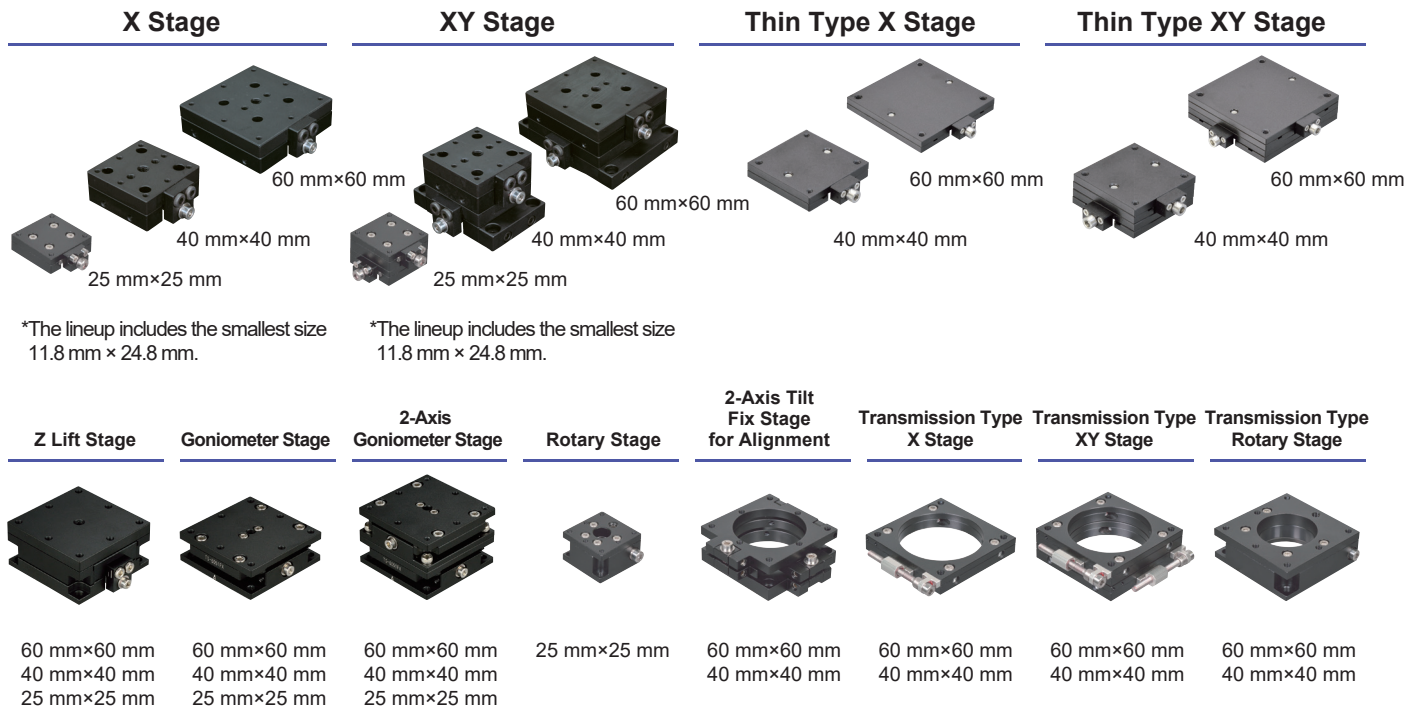

● **Website** <https://www.thk.com/precisionstage/sg/en/> Offered in multiple languages

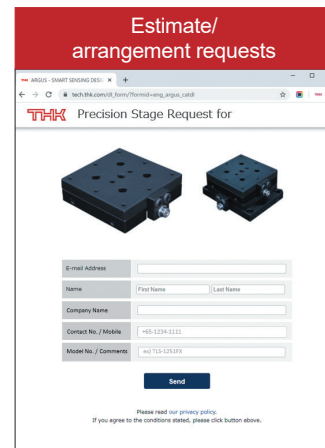
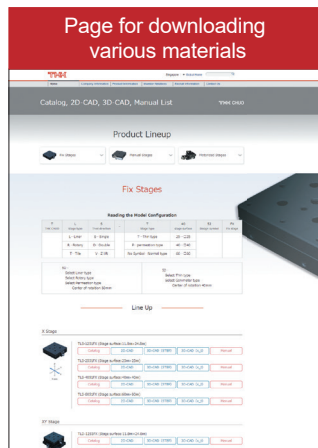
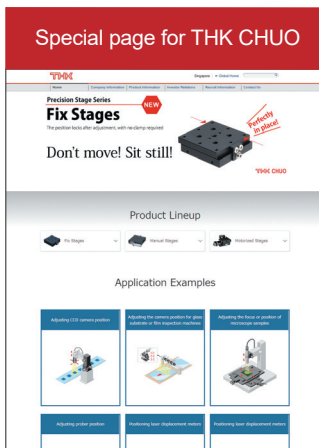

Product catalogues, CAD (2D, 3D), and user manuals can be downloaded.

Estimates/arrangements regarding selected precision stages can be easily requested.



*Outward appearances and specifications are subject to change without notice for the purpose of improvement. Please consult with THK before using.

●Singapore (Japanese/English/Malay/Chinese)
 THK LM SYSTEM Pte. Ltd.
 e-mail: sales@thksg.com
 TEL: +65-6884-5500
www.thk.com/sg

●Indonesia (Japanese/English)
 THK Indonesia Support Service
 e-mail: support-id@thk.co.jp
 TEL: +62-811-9471-282
www.thk.com/id

●Vietnam (Japanese/Vietnamese)
 THK Vietnam Support Service
 e-mail: vietnam@support.thk.com
 TEL: +84-936-936033
www.thk.com/vn

●Thailand (Japanese/English/Thai)
 THK RHYTHM (THAILAND) CO., LTD.
 LM System Division Bangkok Branch
 e-mail: thk@trtc.co.th
 TEL: +66-2751-3001
www.thk.com/th

●Malaysia (Japanese/English/Malay/Chinese)
 THK Malaysia Support Service
 e-mail: malaysia@support.thk.com
 TEL: +65-6884-5500
www.thk.com/my

●Philippines (Japanese/English)
 THK Philippines Support Service
 e-mail: philippines@support.thk.com
 TEL: +65-6884-5500
www.thk.com/ph



HEADQUARTERS 2-12-10 Shibaura, Minato-ku, Tokyo 108-8506 Japan
International Sales Department Phone: +81-3-5730-3860
www.thk.com

CAT.No.L-60ES