

FABREEKA[®]

VIBRATION & SHOCK CONTROL



Cup Mounts

Elastic support elements

Tough and resistant in every situation

Fabreeka VSC Cupmounts offer multidirectional vibration/shock isolation at approximately the same performance in compression, tension and shear applications. These isolators have interlocking components of steel, contributing to their fail-safe design and provides ideal storage elements, even in extremely harsh environments.

VSC Cupmounts are available in four sizes with static loads up to 1,000 kg (2200lbs) per mount. Standard materials are zinc plated steel for metal parts and Chloroprene or highly damped silicone (HDS) for the elastomeric components. Other metals such as aluminum or stainless steel, larger base plates and special elastomers are available on request.

Stationary Applications			Mobile Applications	
Typ	Static load	Natural Frequency	Static load	Natural Frequency
VSC1-2	6,5 - 16 kg	16 - 25 Hz	3 - 6,5 kg	25 - 35 Hz
VSC1-4	14 - 35 kg	16 - 25 Hz	7 - 14 kg	25 - 35 Hz
VSC1-7	25 - 60 kg	16 - 25 Hz	14 - 25 kg	25 - 35 Hz
VSC1-10	45 - 100 kg	16 - 25 Hz	25 - 45 kg	25 - 35 Hz
VSC2-5	14 - 35 kg	16 - 25 Hz	9 - 14 kg	25 - 35 Hz
VSC2-10	25 - 60 kg	16 - 25 Hz	14 - 25 kg	25 - 35 Hz
VSC2-15	35 - 90 kg	16 - 25 Hz	25 - 35 kg	25 - 35 Hz
VSC2-20	55 - 140 kg	16 - 25 Hz	35 - 55 kg	25 - 35 Hz
VSC2-25	70 - 200 kg	16 - 25 Hz	50 - 70 kg	25 - 35 Hz
VSC2-40	90 - 250 kg	16 - 25 Hz	35 - 90 kg	25 - 35 Hz
VSC3-25	40 - 210 kg	12 - 25 Hz	25 - 70 kg	20 - 30 Hz
VSC3-40	65 - 350 kg	12 - 25 Hz	45 - 110 kg	20 - 30 Hz
VSC3-65	90 - 500 kg	12 - 25 Hz	60 - 160 kg	20 - 30 Hz
VSC3-90	130 - 750 kg	12 - 25 Hz	80 - 230 kg	20 - 30 Hz
VSC4-80	75 - 450 kg	12 - 25 Hz	45 - 120 kg	20 - 30 Hz
VSC4-140	100 - 600 kg	12 - 25 Hz	65 - 170 kg	20 - 30 Hz
VSC4-180	200 - 1000 kg	12 - 25 Hz	140 - 325 kg	20 - 30 Hz

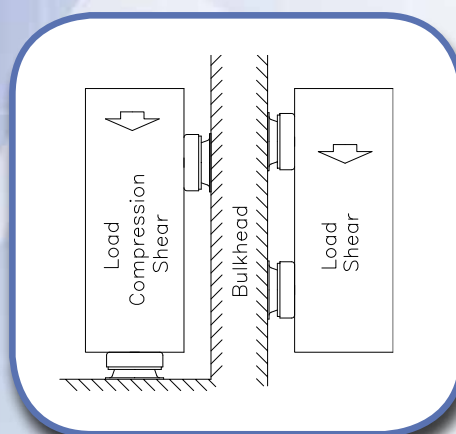
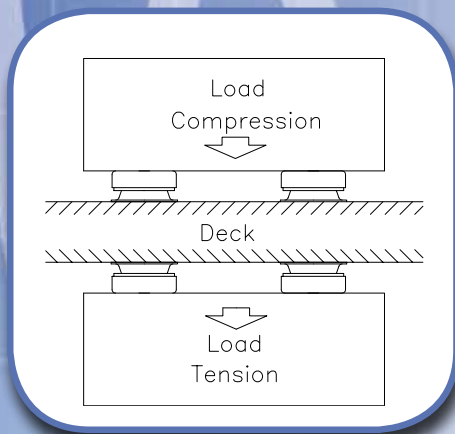

During installation, especially in the mobile sector it is essential to ensure that the mounting distance between each Cupmount in relation to the center of gravity is greater than a ratio of 2:1. At a high center of gravity, we recommend the use of stabilisers, which are attached to the top panel. For difficult applications, Fabreeka engineers can offer technical advice.

Load Deflection curves

VSC 1
VSC 2

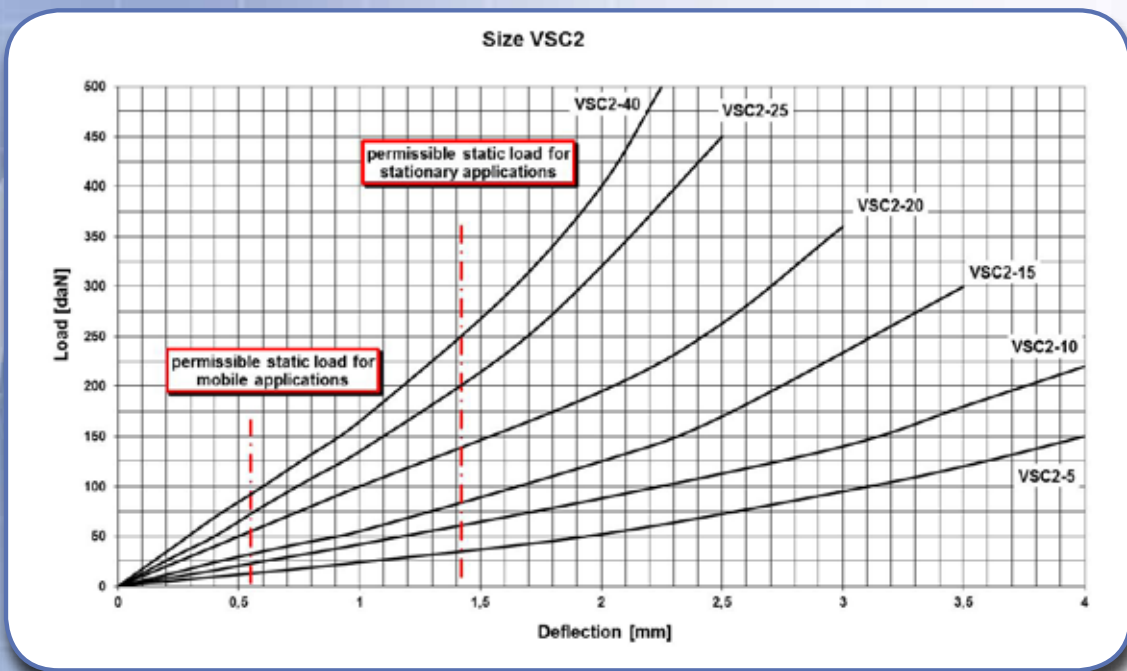
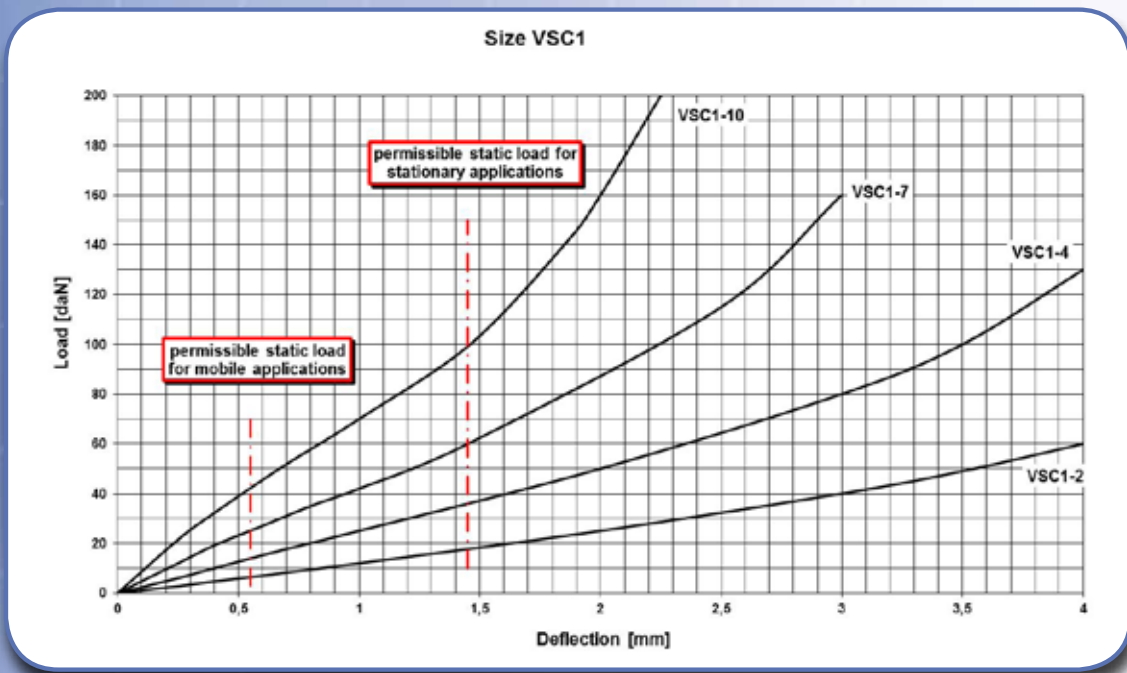

Load Deflection curves

VSC 3

VSC 4

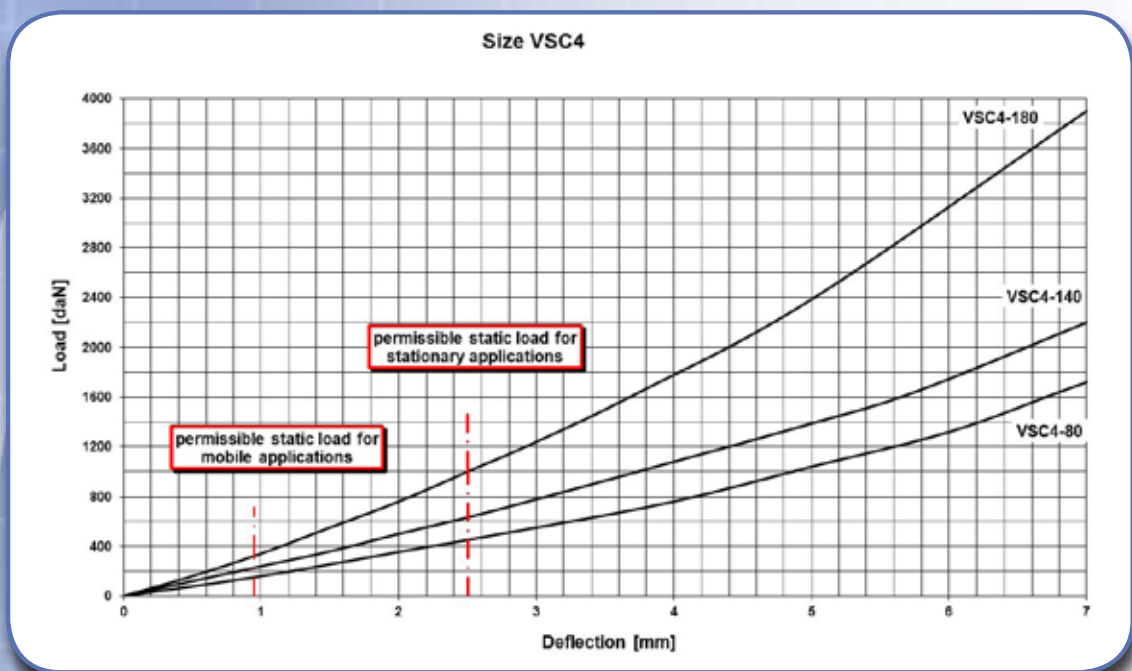
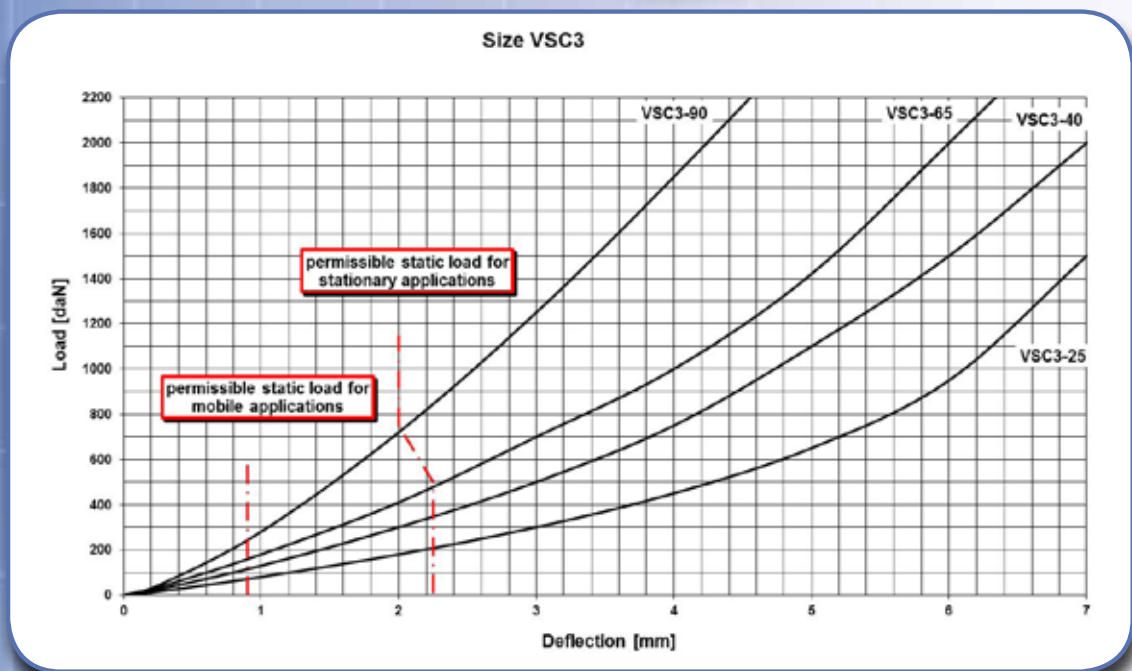

Fabreeka Cupmounts are Rohs compliant. Chloroprene VSC versions are resistant to most oils, fuels and ozone and works effectively at a temperature range from -30°C to +80°C (-20°F to 180°F). With increased demands on temperature or damping capacity we recommend the HDS version with a temperature range of -50°C to +150°C (-80°F to 300°F) and a resonance rise <4

Cupmounts correspond to VG 95369 for elastomer mounts and meet under normal use the MIL-E 5400 and MIL-S-901 E.

Loads and dimensions of our Cupmounts are below. Subject to technical changes.

*the inner frictional heat is not considered at the upper temperature limit.

Dimensions

Typ	Thread	G	Screwed-in depth [mm]	A [mm]	B [mm]	D [mm]	C [mm]	H [mm]	I [mm]	Weight [kg]
VSC1-2 VSC1-4 VSC1-7 VSC1-10	M6 oder M8 M6 oder M8 M6 oder M8 M6 oder M8		20	60	49,5	58	5,5	28	18	0,2
VSC2-5 VSC2-10 VSC2-15 VSC2-20 VSC2-25 VSC2-40	M10 oder M12 M10 oder M12 M10 oder M12 M10 oder M12 M10 oder M12 M10 oder M12		30	76	63,5	76	6,4	38	25	0,45
VSC3-25 VSC3-40 VSC3-65 VSC3-90	M16 M16 M16 M16		19	133	108	124	11,9	63	38	1,8
VSC4-80 VSC4-140 VSC4-180	M16 M16 M16		65	175	143	168	13,5	90	59	4,5

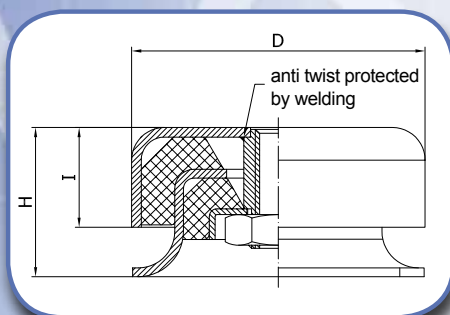
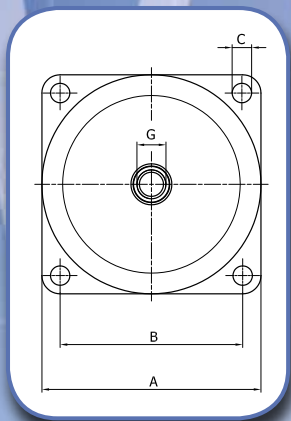

Steel components zinc plated or stainless steel

Associated Applications:

- Military/Defence
- Electronics
- Industrial Machinery
- Transport Machinery
- Electronical Devices
- Hydraulic Systems

Elastomer Data

Environment	Neoprene	Silicone
Temperature	-30°C to +80°C	-60°C to +150°C
Ozone Resistance	good	Excellent
Oil Resistance	Excellent	good
Heat aging	good	excellent

Typical Transmissibility

