



MX SERIES

NMXi | NMX INSTRUCTION MANUAL

SETUP!

SCAN CODE

*USE PHONE CAMERA



or visit www.vaulteksafe.com/support/mx-series/

Thank You For Your Recent Purchase

At Vaultek® we stand behind our product and you our customer. On behalf of the entire team thank you for your purchase. We believe personal defense should be handled seriously and we're excited for you to experience the ultimate performance in smart-security.

STAY SAFE. VAULTEK® SAFE.

Table of Contents

Product Overview	01 / 02
Introduction	03
Warnings	04
Battery Operation / Battery Maintenance	05 / 07
Battery Installation	05
Charging the Battery	06
Master Code Programming	08
Smart Align Biometric Scanner (NMXi Only)	09 / 12
Helpful Programming TIPS	09
Programming Admin Fingerprints (First Two Users)	10
Programming Additional Fingerprints 3-20	11
Deleting Fingerprints	12
Wi-Fi® Setup	12
Smart Key Operations / Warnings	13 / 16
Smart Key Pairing	13
Smart Key Entry Modes	14
To Unpair Smart Key	14
Multiple Safe Management	15
Hot Keys	16 / 18
Tamper Detection	16
Toggle Stealth Mode	16
Toggle Travel Mode	16
Toggle Open Door Alarm	16

View Battery Status	17
Delete Fingerprints	17
Toggle Interior Light	17
Toggle LCD Brightness	17
View Temperature/Humidity	17
Toggle Fahrenheit/Celsius	18
Toggle Smart Key Modes	18
Toggle DMT Sensitivity	18
Toggle Dual Entry Mode	18
Toggle Alert of Manual Unlock	18
Factory Reset	18
Securing Your Safe	19
Modular Interior	19
Adjust Interior Shelf Height	19
Product Registration	20
FAQ	21 / 22
Troubleshooting	23
Customer Support / Warranty	24

Box Contents

Vaultek® Safe	AC Power Adapter and Charging Cable	Owner's Manual
Smart Key Nano and Battery	Twin Pistol Rack	Quick Start Guide
18650 Rechargeable Lithium-ion Battery	Hardware Mounting Kit	Backup Keys (2)

Product Overview

Get to know your Vaultek® MX WiFi Series safe.

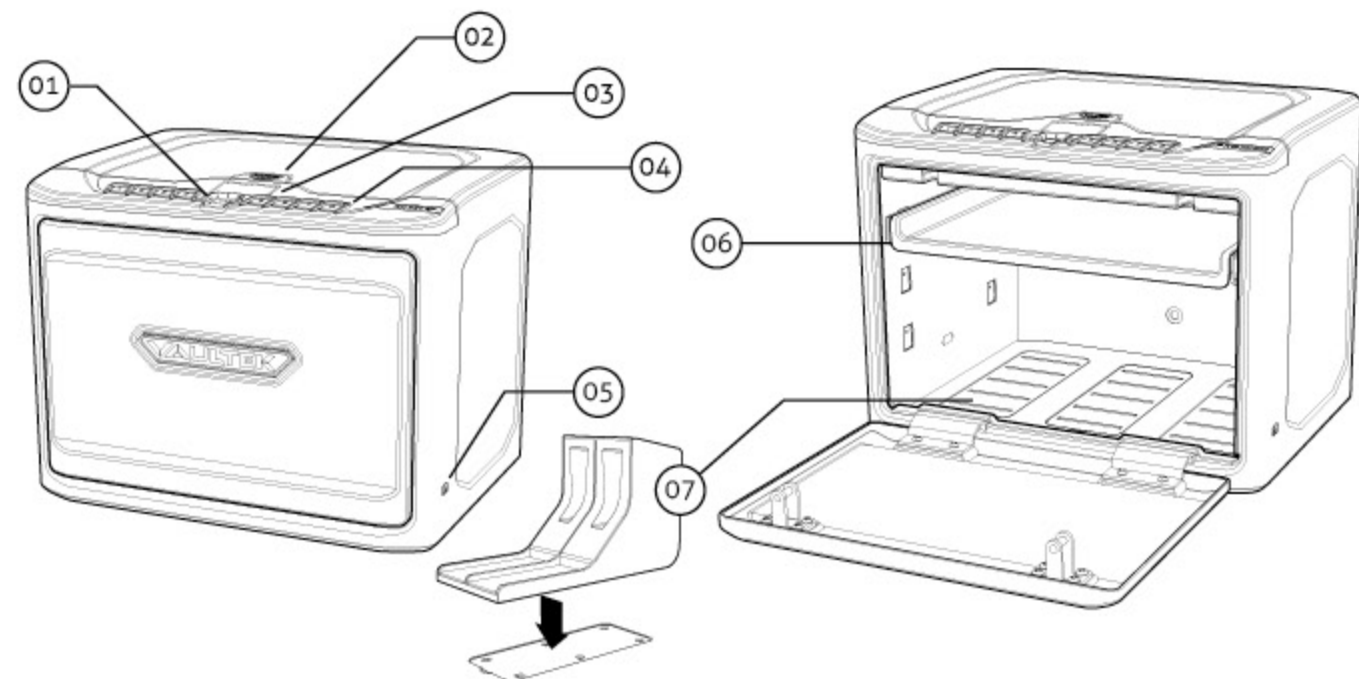

01. Smart Align Biometric Scanner (NMXi Only)

02. Silicone Key Hole Cover

03. LCD Screen

04. Numeric Keypad

05. Micro-USB Charging Port

06. Adjustable Shelf

07. Module System

(Twin Pistol Rack)

LCD Screen Format

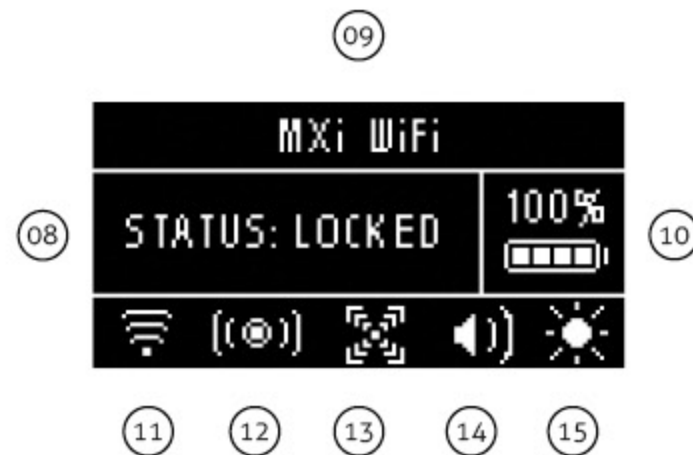

08. Safe Status

09. Safe Name

10. Battery Level

11. Wi-fi® On/Off

12. Smart Key Setting

13. DMT Setting

14. Sound On/Off

15. Interior LEDs On/Off

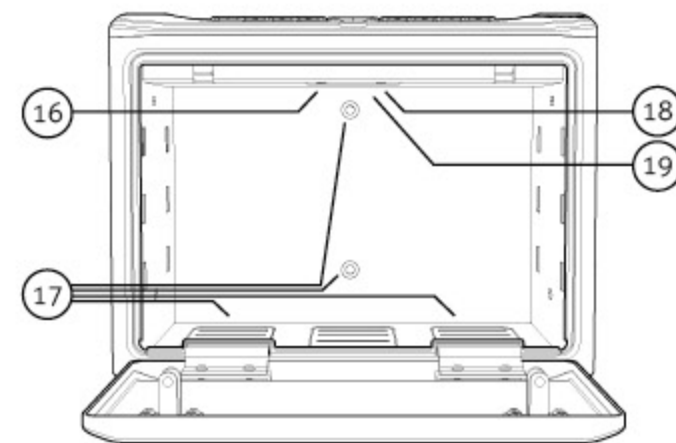

16. PROGRAM Button

17. Pre-Drilled Mounting Holes

18. LED Light Button

19. Battery Compartment

Introduction

The Vaultek® NMX/NMXi is a tough and rugged, quick access, Wi-Fi® enabled smart safe. Its solid structure and penetration resistant design makes it ideal for storing valuables such as firearms, jewelry, cash, and other personal items. Powered by a rechargeable lithium-ion battery, the safe combines high security with complete access control.

Secure Access How to open your Vaultek® Safe.

Biometric Scanner (NMXi Only): Personalized access for up to 20 unique fingerprints. See pages 09 to 12.

Keypad: The numeric keypad responds quickly for rapid access and has a built-in proximity sensor that lights up when your hand brushes against the safe. See page 08 for more information.

Smart Key: Remote for On Demand access. See page 13 and 16 for more information.

Key: Two keys are provided for manual access to the safe in the event the battery dies.

Secure Defense How your Vaultek® Safe keeps people out.

Anti-Impact Latches: Built to withstand forceful impacts and heavy slams.

No External Access Points: A combination of interior mounted hinges and extended anti-pry reinforcement bars help prevent unwanted tools from attempting to break the safe open.

Security Sleep Mode: Activates when six (6) consecutive incorrect keypad entries are entered or (6) incorrect fingerprint scans are made. The safe will not accept any entries for four minutes. If any additional attempts are made the alarm will beep. The security sleep mode can be cleared upon unlock of the safe by any authorized access method including the backup keys.

DMT (Impact Detection): Motion activated alarm can be disabled or enabled with three levels of sensitivity (Low, Medium, and High) using the safe's hot key functions, online dashboard, or Vaultek® Wi-Fi® app.

Alert Notifications: Wi-Fi® connectivity allows you to receive alerts such as push notifications and text alerts during critical safe activity. This includes battery levels, impacts, extreme temperatures, tampering, and anytime the safe is opened.

Warnings

To prevent damage to your Vaultek® unit or injury to yourself or to others, read the following safety precautions before using this unit.

DO NOT PLACE OR STORE THE BACKUP KEYS INSIDE THE SAFE AT ANY TIME. IF THE BATTERY FAILS, YOU WILL BE UNABLE TO OPEN THE SAFE.

DO NOT expose to extreme heat or cold. Battery power may be affected.

DO NOT store loaded guns in this unit. Firearms are serious in nature and must be handled with respect. Store responsibly.

DO NOT get fingerprint sensor wet.

ALWAYS check to make sure door has latched when closing; door requires a firm press and locks automatically.

DISCLAIMERS:

NEITHER SELLER NOR MANUFACTURER SHALL BE LIABLE FOR UNAUTHORIZED ACCESS, ANY INJURY, LOSS OR DAMAGE TO PERSONAL PROPERTY DIRECT OR CONSEQUENTIAL, ARISING OUT OF THE USE OF, OR THE INABILITY TO USE THE VAULTEK® SAFE.

THE USER SHALL DETERMINE THE SUITABILITY OF THE VAULTEK® SAFE BEFORE THE INTENDED USE AND USER ASSUMES ALL RISK AND LIABILITY WHATSOEVER IN CONNECTION THEREWITH. VAULTEK® SAFES ARE NOT INTENDED TO PROTECT AGAINST ENVIRONMENTAL HAZARDS INCLUDING FIRE AND WATER.

Be sure and follow all local and state firearm laws.

DO NOT operate a firearm without proper training and experience.

Check page 16 for Smart Key warnings.

Wi-Fi® is a registered trademark of Wi-Fi Alliance®.

Battery Operations

Your safe uses a 3.7V 18650 rechargeable lithium-ion with a flat top. A minimum 2000 mAh capacity is required, however 2200 mAh or higher can be used to increase operation time.

Battery Installation

- 1 To get started, insert one of your backup keys into the keyhole at the top of the safe (see Figure A). Push key in and rotate the key clockwise to open the safe.
- 2 Locate the battery compartment inside the safe beneath the control panel (see Figure B).
- 3 Remove the battery cover by pressing down on the tab near the top of the cover.

TIP! Before inserting the battery make sure to place the pull string over the battery before closing the door for easy removal.

- 4 Insert the 18650 rechargeable lithium-ion battery (included in accessory box) into the battery compartment. Note that your Vaultek® safe automatically detects the polarity of the battery and can be installed in either direction.
- 5 When the battery is inserted you will hear a short welcome tone and the keypad will light up.
- 6 Once you hear the tone replace the battery cover. You are now ready to program your safe.

IMPORTANT Your Vaultek® safe will automatically lock when you fully close the door.

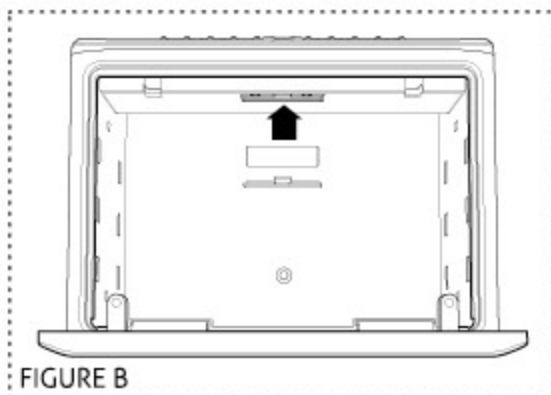

Continue on next page for more information about the battery.

Charging the Battery

Your Vaultek® safe is powered by a rechargeable lithium-ion battery and comes with a charging kit which includes an AC power adapter and a micro-USB cable. Safe and micro-USB cable can be used with all international power adapters. Under normal usage, a fully charged battery can last up to one month.

Due to powerful features with MX Series it is recommended to keep the safe plugged in.

- 1 **To recharge the safe**, plug the micro-USB cable into the micro-USB receiving jack located on the lower right side of the safe (Figure C) and connect to a standard USB port or wall outlet using the AC power adapter. Approximate recharge time is 3.5 hours.
- 2 When charging the LED light above the micro-USB jack (Figure C) will be solid RED and GREEN indicating charged.

Charging TIPS

- A After installing the battery, use the charging kit provided to charge the unit 100%.
- B The charging kit can also function as an external power supply, which means you can open your safe even when the battery is depleted.
- C Leaving your safe plugged in continually will **not** harm the safe or battery. However, to preserve battery life we suggest that you unplug occasionally to allow the battery to cycle down.
- D A specially designed Vaultek Powerpack is available as a separate accessory to extend operation time.
- E The adapter used to charge the battery should output 5V/2000mA or above when using micro-USB cable.

See the FAQ section for additional information about the battery.

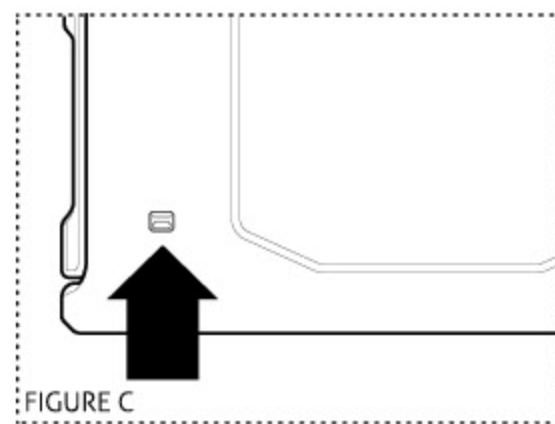

Battery Maintenance

Testing the Battery Power

To check the battery level, press and hold '6' and '8' key together on the keypad for 3 seconds.

Low Battery

If the LED on the control panel blinks RED several times and you hear several rapid beeps when opening the safe, your battery level is critically low and your safe needs to be recharged immediately.

Soft Reset TIP

In the event the battery dies or a soft reset is performed (battery removal and installation) the safe will restore default settings for DMT, interior light, sound, the Smart Key, and Alert of Manual Unlock feature. These settings will need to be readjusted, however the master code and fingerprint scanner will not be affected.

IMPORTANT

Use a 3.7V 18650 rechargeable lithium-ion battery with a flat top. A minimum 2000 mAh capacity is required, however 2200 mAh or higher can be used to increase operation time.

A high capacity battery upgrade is available as an accessory through our website.

The adapter used to charge the battery should output 5V/2000mA or above when using micro-USB cable.

For setup, tutorials, and FAQs visit www.vaulteksafe.com/support/mx-series/

Master Code Programming

First time users should change the default code as soon as possible to prevent unauthorized access to your safe.

TIP: Code Requirements

- Your code can be a minimum of 4 and a maximum of 8 digits. We recommend a code 6 to 8 digits in length using at least one of each key to make it more difficult for someone to guess your code. For your security, the safe will time out and sleep for 4 minutes if 6 incorrect entries are made.
- Two keys cannot be pressed simultaneously.
- Programming a new code will overwrite your previous code.

- 1 Open the safe. With the safe open, press and hold the '1' key then the "PROGRAM" button together (3 seconds)(Figure D) until the LCD screen prompts you to enter your new code.
- 2 Enter your NEW master code.
- 3 **IMMEDIATELY** Press and hold the '1' key then the "PROGRAM" button together a second time (3 seconds) until the LCD screen prompts you to re-enter your new code.
- 4 Enter your NEW master code a second time.
- 5 **IMMEDIATELY** Press and hold the '1' key then the "PROGRAM" button together a third time (3 seconds) until the LCD screen confirms the code change is complete.

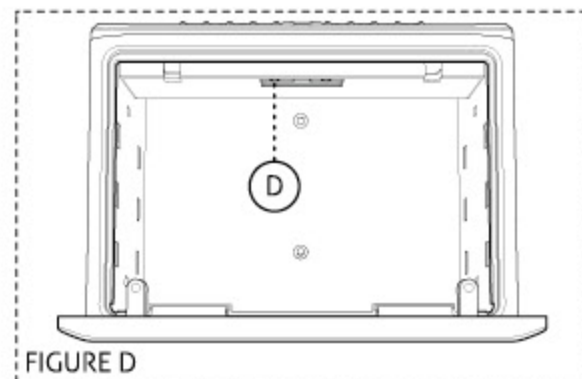

If you make a mistake and the new code will not work, simply start over with step 1.

For setup, tutorials, and FAQs visit www.vaulteksafe.com/support/mx-series/

Smart Align Biometric Scanner (NMXi Only)

Biometrics are methods of authenticating the identity of a person based on physical or behavioral characteristics. Biometric fingerprint authentication refers to technology that measures and analyzes human physical characteristics for identification and authentication purposes. The smart align biometric system guides your finger placement for consistent and accurate results.

Everyone has their own unique fingerprints, and what makes them unique is the pattern of ridges, valleys, and minutiae points that comprise an individual print. Vaultek® and their leading engineering group has developed proprietary technology to read and match fingerprints with unmatched speed and accuracy. That means that only authorized users have access to your valuables. The safe is capable of storing fingerprint data for up to 20 unique authorized users. A user consists of 5 scans of the same finger during registration. Once a user's fingerprint data is stored in the safe and encrypted, it cannot be copied or stolen.

Helpful Programming TIPS

- **Place the core of the fingerprint flat** (Figure E+F) over the center of the scanner (this allows the scanner to read where most of the fingerprint detail is located) see (Figure E).
- Adjust your finger slightly between scans for increased accuracy.
- Excessive moisture, lotions, or dirt will affect your fingerprint and may cause inaccurate sensor reading.
- If you are having difficulty with your print, program the same finger 4 or 5 times. You have 20 slots available for programming and you can also try your thumb as it has more surface area to read.

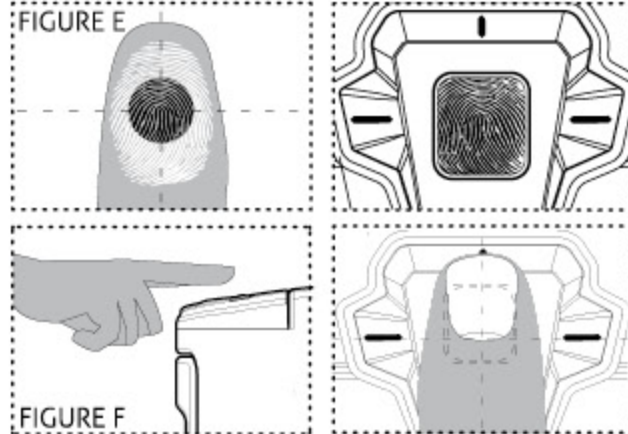

ATTENTION! (Figure F)

Position your finger flat against the scanner to increase the amount of readable information.

Continue on next page for more information about the fingerprint scanner.

Programming Admin Fingerprints (First Two Users)

The 1st and 2nd fingerprints will be recognized as administrative fingerprints and will be used to authorize additional users. To program additional users please refer to the next page.

- 1 Open the safe. Program 1st fingerprint by pressing and holding the '2' key then the "PROGRAM" button together (3 seconds)(Figure G) until the screen prompts you to scan the 1st of five scans.
- 2 Using the helpful programming tips provided on page 09 place your finger on the fingerprint scanner for the 1st of five scans. When the safe beeps, and the screen prompts the next scan remove your finger. If the screen indicates a failed to complete then start over with step 1.
- 3 Place finger again over the scanner until the safe beeps and the screen prompts the next scan and lift. You will repeat this process until all scans (1-5) are programmed.
- 4 Close door and test to see if the safe will open using your fingerprint. If you experience issues refer to the helpful programming tips listed on page 09 or check our tutorials online at vaulteksafe.com/support/mx-series/.
- 5 Repeat steps 1 through 4 to add the 2nd administrative fingerprint.

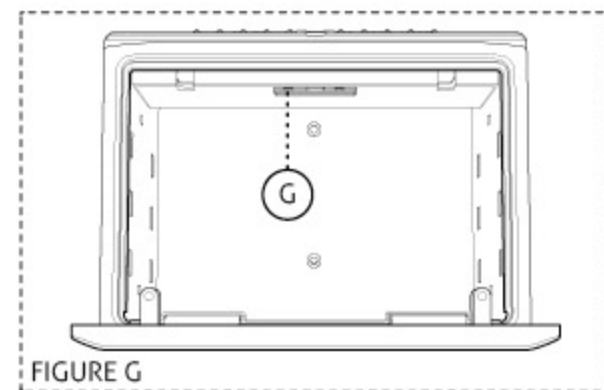

Continue on next page to program fingerprints 3-20 and deleting fingerprints.

For setup, tutorials, and FAQs visit www.vaulteksafe.com/support/mx-series/

Smart Align Biometric Scanner (NMXi Only)

Programming Additional Fingerprints 3-20

The first two fingerprints programmed into the safe are the administrative fingerprints. Any additional users programmed require authorization from one of these fingerprints.

- 1 Open the safe. Program additional fingerprints by pressing and holding the '2' then "PROGRAM" button together (3 seconds)(Figure G on page 10). The screen will prompt you to scan one of the administrative fingerprints.
- 2 Place one of the first two programmed administrative fingerprints on the scanner and remove when the safe beeps and screen authorizes the print. You can now program a NEW fingerprint.

TIP: If the administrative print is left on the scanner too long the safe will begin to program that fingerprint into the safe again and not the NEW fingerprint. If this happens start over with step 1.

- 3 Using the helpful programming tips provided on page 09 place the NEW finger on the scanner. When the safe beeps and the screen prompts the next scan remove your finger.
- 4 Place finger again over the scanner until the safe beeps and the screen prompts the next scan and lift. You will repeat this process until all scans (1-5) are programmed.

For setup, tutorials, and FAQs visit www.vaulteksafe.com/support/mx-series/

Deleting Fingerprints

Individual fingerprints can not be deleted from the keypad on the safe. Following this procedure will erase all of the fingerprints including both administrative fingerprints. If you wish to delete individual fingerprints, you must use the Vaultek® Wi-Fi® app or online dashboard. This procedure will not affect the keypad master code.

TIP! Fingerprints can also be temporarily disabled. Using the online Web Dashboard or Vaultek® Wi-Fi® app individual prints can be temporarily disabled and can not access the safe. This does not delete the fingerprint, only temporarily disables it until enabled again as needed.

- 1 Press and hold the '3' key then the "PROGRAM" button together until the safe beeps and the screen prompts you to enter your master code.
- 2 Enter your master code on the keypad. If the code is correct, the safe will beep and the screen will indicate deletion of all the fingerprints.

Wi-Fi® Setup

Visit www.vaulteksafe.com/support/mx-series/ for complete setup instructions and tutorial videos.

For setup, tutorials, and FAQs visit www.vaulteksafe.com/support/mx-series/

Smart Key Operations

Your Vaultek® safe supports quick access with the included Smart Key Nano. **Take caution when using this feature and be responsible. Security can be compromised in the event it is lost or stolen. Only pair Smart Key after thoroughly understanding the inherent risks.**

IMPORTANT

Before you can pair the Smart Key to your safe connect the pre-installed battery by removing the pull tab from the side of Smart Key (Figure H).

Smart Key Pairing (Three Steps)

IMPORTANT Be sure to follow **ALL** steps for proper function.

- 1 Press and hold the '5' key then "PROGRAM" button together (3 seconds) until the LCD screen indicates CONNECTING.
- 2 Aim Smart Key Nano towards the safe and press. If the safe beeps and the screen indicates COMPLETE then the Smart Key has paired successfully. If the screen indicates FAILED TO PAIR then simply start over with step 1.
- 3 **Set Smart Key Entry Mode:** After pairing, Smart Key Nano will be immediately active to test functionality, but then deactivate. Smart Key settings will need to be set to either On Demand or Progressive in order for Smart Key to open your safe. See Smart Key Entry Modes on next page for more information.

IMPORTANT Smart Key Nano should be mounted less than 6 feet away from safe for proper operation. Use in long range is not recommended as it may cause accidental opens.

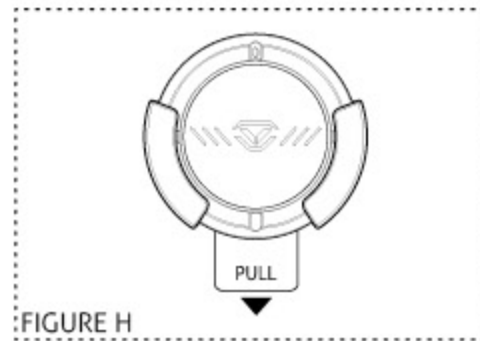

FIGURE H

Continue on next page for more information about Smart Key.

Smart Key Entry Modes

After pairing you can toggle between access modes from the keypad, Wi-Fi® smartphone app, or the online Web Dashboard. To toggle modes from the safe's keypad press and hold the '6' key then "PROGRAM" button together until the LCD screen indicates each mode as below.

OFF

Progressive Entry Mode Safe goes into sleep mode and will require you to wake up the safe before using Smart Key. You can wake up the safe by pressing any key or brushing your hand across the keypad of the safe (backlit keys will turn RED).

On Demand Entry Mode This mode grants immediate access to your safe without having to wake it up.

Warning: On Demand entry mode can open a safe in another room and/or out of sight. To reduce risk of an unattended open safe we recommend using Progressive entry mode.

On Demand entry mode requires significant power usage and can greatly reduce operation time. We suggest setting the Smart Key to Progressive entry mode to conserve battery, unless the safe is constantly plugged into a power outlet.

To Unpair Smart Key

NOTE: Disabling the Smart Key function from the Wi-Fi® app, Web Dashboard, or safe's keypad will NOT delete a paired key from the safe's memory. In the event a Smart Key is lost or stolen, you can delete the lost Smart Key from the safe's memory by using a couple different methods:

- A Press and hold '5' key then "PROGRAM" button together (3 seconds) until the LED flashes RED and the LCD screen indicates CONNECTING. This is the same sequence used when initially pairing. After the screen indicates FAILED TO PAIR the safe will delete a paired Smart Key from memory.
- B Anytime a new Smart Key is paired with the safe, the previous key will be erased from the safe's memory.

For setup, tutorials, and FAQs visit www.vaulteksafe.com/support/mx-series/

Smart Key Operation

Multiple Safe Management

- A Multiple Smart Keys can not pair with the same safe. It is recommended to pair one Smart Key per safe.
- B Recommended setting when using the Smart Key is Progressive entry mode.
- C You can manage multiple safes through the Vaultek® Wi-Fi® smartphone app and Web Dashboard.

CAUTION when managing multiple safes in On Demand entry mode there is a chance you can open all safes within range.

Battery Replacement

The pre-installed battery will last approximately two years before requiring replacement. When needed follow the steps below to complete replacement.

- 1 Access the battery compartment by twisting the bottom battery cover counterclockwise, then remove the cover.
- 2 Remove the old battery by firmly lifting up on its sides to release it from its clips. A small screwdriver can help pry the battery out if used carefully.
- 3 Insert a new model CR2032 battery positive side (+) facing up. Be sure and insert the battery edge under the brass clip first (Figure I), then press firmly into place (Figure I). Replace the battery cover and twist clockwise to tighten in place.

TIP! The battery will not install correctly without first being placed under the brass clip.

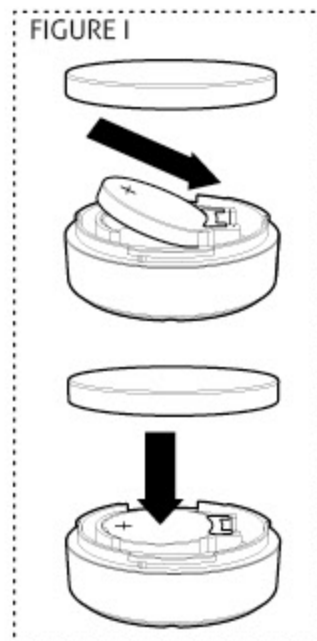

Smart Key Warnings

Take caution when using this feature and be responsible. Security can be compromised in the event Smart Key is lost or stolen. Only pair Smart Key after thoroughly understanding the inherent risks.

WARNING anyone including children can access the safe via Smart Key.

ALWAYS unpair Smart Key in the event it is lost or stolen.

WARNING On Demand entry mode can open a safe in another room and/or out of sight. To reduce risk of an unattended open safe we recommend using Progressive entry mode.

IMPORTANT On Demand entry mode requires significant power usage and can greatly reduce operation time on a single charge. We suggest keeping the safe in Progressive entry mode. If using On Demand entry mode try keeping the safe plugged in.

Hot Keys More Hot Keys on the next page.

Tamper Detection

Press and hold '2' and '4'



To check for tampering press and hold keys '2' and '4' together for 3 seconds. The screen will indicate TAMPERING or CLEAR. You can reset the tamper detection by opening the safe through one of the authorized entry points. Tampering includes incorrect keypad entries as well as incorrect fingerprint scans.

Toggle Stealth Mode

Press and hold '1' and '3'



To toggle the sound ON/OFF press and hold keys '1' and '3' together for 3 seconds. The screen will indicate the sound is ON and beep or the screen will indicate OFF and not beep.

Toggle Travel Mode

Press and hold '1' and '8'



Save battery life by disabling the proximity sensor, fingerprint sensor, keypad, smart key, Wi-Fi®, and status bar. To toggle travel mode ON/OFF press and hold keys '1' and '8' together for 3 seconds. The screen will indicate ENABLED or DISABLED.

Toggle Open Door Alarm

Press and hold '3' and '5' and "PROGRAM"



Your safe features an open door alarm that will sound when the safe door is left open for more than 8 minutes. By default, this alarm is ON. To toggle off press and hold keys '3' and '5' and PROGRAM together (3 seconds). The screen will indicate ON or OFF.

Hot Keys

View Battery Status

Press and hold '6' and '8'



Delete Fingerprints

Press and hold '3' then "PROGRAM" then enter master code



Toggle Interior Light

Press and hold '5' and '7'



Toggle LCD Brightness

Press and hold '5' and '8'



View Temperature/ Humidity

Press and hold '2' and '5'



Toggle Fahrenheit/Celsius

Press and hold '2' and '6'



To check the battery level press and hold keys '6' and '8' together for 3 seconds. The screen will indicate the battery level. See pages 06 to 07 for more information.

To delete fingerprints press and hold the '3' key then "PROGRAM" button together until the safe beeps and the screen prompts you to enter your master code. Enter your master code on the keypad. If the code is correct, the safe will beep and the screen will indicate deletion of all the fingerprints. This will remove ALL the fingerprints. To delete individual fingerprints you can use the Vaultek® Wi-Fi® smartphone app or Web Dashboard.

To toggle the interior light ON/OFF press and hold keys '5' and '7' together for 3 seconds. With the light toggled to ON you can press the LIGHT button inside the safe to illuminate the LED lights and you can also adjust the brightness from the Vaultek® Wi-Fi® smartphone app or Web Dashboard. If the light is toggled OFF the light will be disabled.

The LCD screen has four brightness levels: 25%, 50%, 75%, and 100%. To toggle the LCD brightness press and hold '5' and '8' together for 3 seconds. The screen will indicate the brightness level.

Your Vaultek® safe has built in sensors to monitor the internal temperature as well as the relative humidity inside your safe. Press keys '2' and '5' together to display the information on your safe's LCD screen. You can also monitor the safe's temperature and humidity from the Vaultek® Wi-Fi® smartphone app and online Web Dashboard. You even have the option to set thresholds and be alerted of any significant changes.

By default, the safe will measure temperature in Fahrenheit. By pressing keys '2' and '6' together you can toggle the display to show temperature in either Fahrenheit or Celsius.

Toggle Smart Key Modes

Press and hold '6' then "PROGRAM"



Toggle DMT Sensitivity

Press and hold '7' then "PROGRAM"



Toggle Dual Entry Mode

Press and hold '8' then "PROGRAM"



Toggle Alert of Manual Unlock

Press and hold '3' and '6' then "PROGRAM"



Factory Reset

Press and hold '2' and '7' then "PROGRAM"



Smart Key has THREE modes: OFF, Progressive Entry Mode, and On Demand Entry Mode. **OFF** disables Smart Key access. **Progressive Entry Mode** requires that you wake the safe first (keypad illuminates red) and then activate the Smart Key. **On Demand Entry Mode** grants immediate access when activating the Smart Key. Pressing and holding the '6' key then "PROGRAM" button together for 3 seconds will allow you to toggle through each mode from the keypad. You may also alternate modes in the Vaultek® Wi-Fi® app or Web Dashboard.

Your Vaultek® safe has a built-in accelerometer and corresponding alarm that alerts of any attacking to your safe including bumps and impacts, DMT (**Impact Detection**). DMT is enabled by default and its sensitivity has three settings; Low, Medium, and High. You can toggle through these settings by pressing and holding the '7' key then "PROGRAM" button together for 3 seconds. The screen will indicate LOW, MEDIUM, and HIGH as well as DISABLED.

To toggle the Dual Entry ON/OFF press and hold the '8' key then "PROGRAM" button together for 3 seconds. The screen will indicate ENABLED or DISABLED. If the Dual Entry is toggled ON, you will be required to enter your master code and fingerprint (and vice versa) to open the safe. This mode requires that at least one fingerprint be programmed into the safe.

If the Alert of Unlock is on, and someone opens the safe with either the key or by picking the lock, the keypad will start flashing. To toggle Alert Unlock press and hold keys '3' and '6' then "PROGRAM" button together for 3 seconds. The keypad will flash GREEN indicating enabled or RED indicating disabled. If ON and activated it can only be cleared by entering master code. Default is OFF.

Press keys '2' and '7' and PROGRAM together for 3 seconds. **IMPORTANT** The Factory Reset erases ALL programmed information and restores the safe to its default settings. This includes any network configurations and enrolled fingerprints. The master code is reset to 1-2-3-4 and the safe will restart. The safe must be configured again to work with the Vaultek® Wi-Fi® smartphone app and the Web Dashboard.

Securing Your Safe

Your Vaultek® safe can be secured via the included mounting screws to a flat surface using the pre-drilled holes on the bottom and back of the safe.

TIP: Make sure you have enough clearance for the door to open properly before mounting the safe.

- 1 Position the safe on a flat surface where you want to mount it.
- 2 Use a pencil to mark the holes for drilling.

TIP: Remove the covers to access bottom mounting holes.

- 3 Remove safe and drill pilot holes.
- 4 Position safe in place and install screws through safe into pilot holes. Tighten screws.

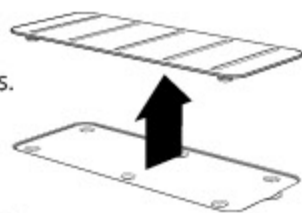

Modular Interior

Your MX Series safe features a customizable interior system with a height adjustable pull out shelf and drop in modules to help with storage and organization.

Adjust Interior Shelf Height

- 1 Lift the shelf vertically to remove from mounting brackets.
- 2 Remove the screw/mounting brackets from the sidewalls and reinstall at the desired height.
- 3 Place shelf back onto the mounting brackets and press down firmly to install.

Drop In Modules

A twin pistol rack is included and can be placed wherever there is an insert cover. Remove the covers to access the slots to attach each module, and snap into place. A range of different modules are available for purchase.

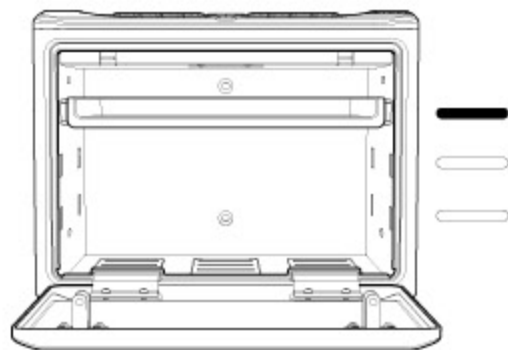

Product Registration

Vaultek® strongly encourages you to register your safe as soon as you receive it. **Registration provides many benefits including three year warranty, technical support, and ordering replacement keys should you misplace them.** Your Vaultek® safe has a unique product number on the inside of the battery door and a 4-digit ID number engraved on the keys. You will need these numbers to register your safe.

- 1 Locate your product number. It is printed on the first page of this user manual and on the back of the battery door (Figure J/K).
- 2 Find your 4-digit ID number engraved on the keys (Figure L).
- 3 Please visit the Vaultek® website at vaulteksafe.com and click Support/Product Registration.
- 4 Enter the required information in the form and click submit.

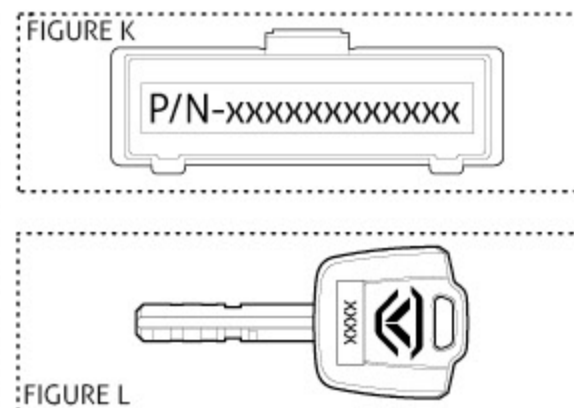
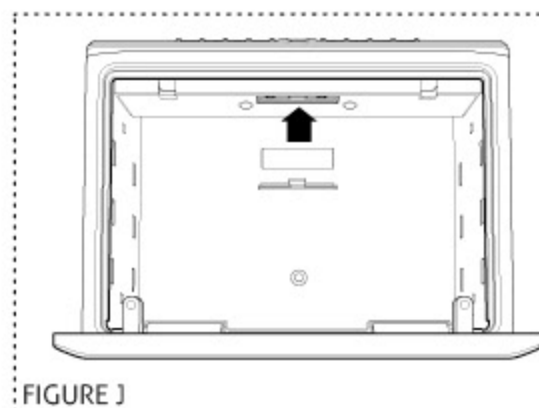

For setup, tutorials, and FAQs visit www.vaulteksafe.com/support/mx-series/

Battery

Q: Can I keep the safe plugged in at all times?

A: Leaving your safe plugged in continually will **not** harm the safe or battery. However, to preserve the battery life we suggest that you unplug occasionally to allow the battery to cycle down.

Q: What happens to the fingerprints that are stored in my Vaultek® safe when the battery dies?

A: The safe retains all fingerprints in the even of battery failure. Once the power is restored by inserting the AC adapter cable, the unit will function as it did before the power loss.

Q: What type of battery does my Vaultek® safe use?

A: Use a 3.7V 18650 rechargeable lithium-ion battery with a flat top. A minimum 2000 mAh capacity is required, however 2200 mAh or higher can be used to increase operation time. A battery upgrade is available through our website at www.vaulteksafe.com.

Q: Can I use a battery of more than 2000 mAh?

A: Yes, a minimum 2000mAh capacity is required, however 2200 mAh or higher can be used to increase operation time. A battery upgrade is available through our website at www.vaulteksafe.com.

Fingerprint Scanner (NMXi Only)

Q: How do I improve fingerprint success rate?

A: The most helpful tip is to program the same finger 4 to 5 times. You have 20 slots available for programming and you can also try your thumb as it has more surface area to read. More tips on page 09.

Q: If I cut my finger, does the fingerprint heal the same as before and will it open my safe?

A: Usually yes, although if the cut is significant or requires stitches scar tissue may form as a result causing a change in your fingerprint. That is why we recommend enrolling additional user fingerprints and also fingerprints from your other hand.

Q: If I cut my finger, does the fingerprint heal the same as before and will it open my safe?

A: Usually yes, although if the cut is significant or requires stitches scar tissue may form as a result causing a change in your fingerprint. That is why we recommend enrolling additional user fingerprints and also fingerprints from your other hand.

Keys

Q: What happens if I lose the keys?

A: First, make sure you registered your safe in the event you do lose your keys. Visit Support at vaulteksafe.com. Be prepared to provide your order details and product number.

Misc.

Q: Can I travel with my Vaultek® safe through US Customs or TSA Security at the airport?

A: Yes, there are no restrictions on carrying this type of item. Please be aware that you may be asked to open your safe. Rather than passing it through x-ray we recommend that an enrolled user be present during the transport of this item in case such a request is made by a government authority. If transporting a firearm, be sure the safe is checked or included with checked luggage and that you notify your airline agent at check in.

Wi-Fi®

Q: How to setup up Wi-Fi®?

A: Visit www.vaulteksafe.com/support/mx-series/ for complete setup instructions and tutorial videos.

If you experience any issues with your safe, try the following solutions.

Smart Key is not working.

A: After pairing you need to assign an entry mode. Refer to Step 3 on page 13. After Smart Key is paired you need to assign to either On Demand or Progressive entry mode, otherwise Smart Key will disable after pairing.

Fingerprint scanner works sometimes and not others.

A: We have a few suggestions to help improve the success rate on page 09.

The keypad is not responding

A. Remove the battery and reinstall. This is a soft reset for the safe. See if you are able to open the safe using the keypad or reprogram the safe's master code. If you are still experiencing issues please email us at support@vaulteksafe.com with your order details.

Door is not engaging.

A: The door requires a firm press. You will feel the latches engage if you press slowly. Feel/listen for the click.

Sound is not working.

A: To toggle the sound ON/OFF press and hold keys '1' and '3' together for 3 seconds. The LCD screen will indicate the sound is ON and beep or the screen will indicate OFF and not beep. If the sound is toggled on and you still can't hear it, have someone else in your house listen as the sound is high pitched.

Unable to change master code.

A: Refer to page 08 of the user manual or check our tutorials online at vaulteksafe.com/support/mx-series/.

Soft Reset: Remove the battery and reinstall. This is a soft reset to the safe. Refer to page 07 for more details.

STOP! Do not return to retailer. If you have any questions about your Vaultek® safe or need help configuring the system, please visit vaulteksafe.com/support/mx-series/.

Customer Support

If you have a problem with your Vaultek® safe that is not answered in the FAQ section of this manual, we encourage you to visit www.vaulteksafe.com/support/mx-series/.

Limited Warranty (Terms and Conditions)

Vaultek® IS COMMITTED TO PROVIDING PRODUCTS OF HIGH QUALITY AND VALUE AND MAKES EVERY EFFORT TO ENSURE ITS PRODUCTS ARE FREE OF DEFECTS.

Vaultek® guarantees your safe will be free of defects in materials or workmanship for a period of two years from the date of original purchase from an authorized dealer and three years with verified product registration.

The warranty is only valid for the original purchaser and not transferable. This warranty is only valid for products purchased and operated in the U.S. This warranty does not cover abuse, misuse, use in any manner for which is not designed, neglected, modification, damage inadvertently caused by the user, accidents and/or tampering.

If service is needed Vaultek will, at its option, exchange or repair without charge for parts or labor. Upon authorization of warranty service, customers are responsible for securely packaging product. Additionally, customers are responsible for costs of shipping to and from Vaultek service center.

If the claimed defect cannot be identified or reproduced, customers will be held responsible for the costs incurred. Please have the following information available before you begin a claim with Vaultek:

- Purchaser's name, mailing address, email address, and a phone number.
- Copy of receipt or online order number (if purchased directly from us or Amazon)
- Authorized Dealer Name (if applicable)
- Detailed description of the problem

NEITHER SELLER NOR MANUFACTURER SHALL BE LIABLE FOR ANY INJURY, LOSS OR DAMAGE, DIRECT OR CONSEQUENTIAL, ARISING OUT OF THE USE OF, OR THE INABILITY TO USE THE VAULTEK® SAFE.

FCC

This device has been evaluated to meet general RF exposure requirement, and this device can be used in portable exposure condition without restriction.

FCC statements:

This device complies with part 15 of the FCC rules. Operation is subject to the following two conditions: (1) this device may not cause harmful interference, and (2) this device must accept any interference received, including interference that may cause undesired operation.

NOTE: The manufacturer is not responsible for any radio or TV interference caused by unauthorized modifications or changes to this equipment. Such modifications or changes could void the user's authority to operate the equipment.

NOTE: This equipment has been tested and found to comply with the limits for a Class B digital device, pursuant to part 15 of the FCC Rules. These limits are designed to provide reasonable protection against harmful interference in a residential installation. This equipment generates uses and can radiate radio frequency energy and, if not installed and used in accordance with the instructions, may cause harmful interference to radio communications. However, there is no guarantee that interference will not occur in a particular installation. If this equipment does cause harmful interference to radio or television reception, which can be determined by turning the equipment off and on, the user is encouraged to try to correct the interference by one or more of the following measures:

- Reorient or relocate the receiving antenna.
- Increase the separation between the equipment and receiver.
- Connect the equipment into an outlet on a circuit different from that to which the receiver is connected.
- Consult the dealer or an experienced radio/TV technician for help.

For setup, tutorials, and FAQs visit www.vaulteksafe.com/support/mx-series/



VAULTEK®

37 North Orange Ave. Suite 800B Orlando, FL 32801

VAULTEKSAFE.COM