



OWNER'S & INSTALLATION MANUAL

QUICKTOUCH VAULT

Models:

QTV100D Black (3418944)

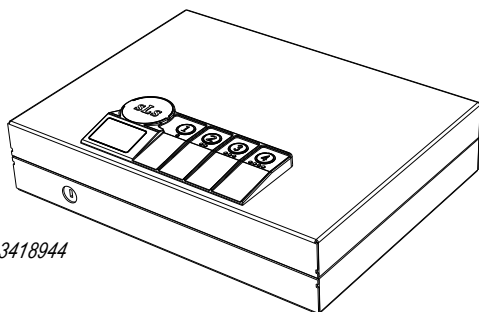

3418944

SURELOCK-SECURITY.COM

SAFETY INFORMATION

THE INFORMATION ENCLOSED PROVIDES A QUICK REFERENCE OF THE OPERATIONS AND MAINTENANCE OF YOUR QUICKTOUCH VAULT. READ THE FOLLOWING SAFETY PRECAUTIONS BEFORE USE. WE ADVISE YOU RETAIN THIS MANUAL FOR FUTURE REFERENCE.

1. Extreme temperatures may affect the power supply of this product. Exposing to extreme heat or cold may affect the battery power.

DO NOT PLACE OR STORE THE BACKUP KEYS INSIDE THE VAULT AT ANY TIME. STORE THEM IN AN ALTERNATIVE LOCATION, AS BACKUP.

2. Remove ammunition from gun before storing in this product. Firearms are serious in nature and must be handled with respect. Store responsibly. Be sure to follow all local and state firearm laws. Do not operate a firearm without proper training and experience.
3. Always check to ensure the door has latched when closing. The vault lid may require a firm press to lock. Do not over-stuff your product. This may cause the locking mechanism to jam. If this occurs, use the backup key to unlock.



COPYRIGHT NOTICE

Copyright 2022. All right reserved. No part of this manual may be copied, transmitted, transcribed, stored in a retrieval system, in any form or by any means without expressed written permission of,

Dansons

8877 North Gainey Center Drive, Scottsdale, AZ, USA 85258

www.surelock-security.com

TABLE OF CONTENTS

| | |
|---------------------------|---|
| Safety Information | 2 |
| Parts & Features | 4 |
| Connecting To Power | 5 |
| Code Programming | 6 |
| Anchoring The Vault | 7 |
| Use & Maintenance | 8 |
| Warranty | 9 |

PARTS & FEATURES

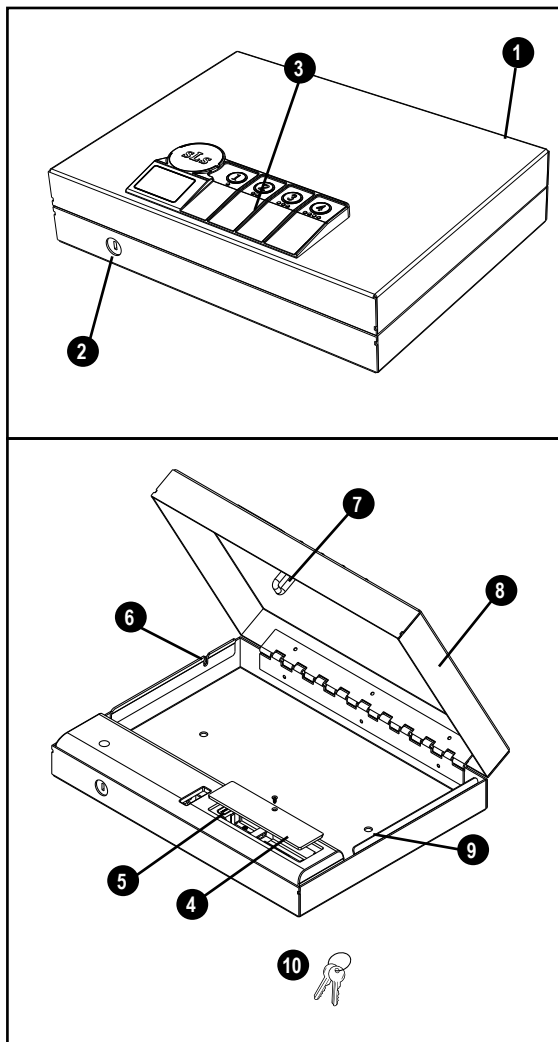

1. **POWER CABLE PORT**
LOCATED ON BACK OF VAULT
(NOT INCLUDED)
2. **KEY HOLE**
3. **KEYPAD KEYS**
4. **BATTERY COMPARTMENT**
REQUIRES 4 AAA ALKALINE
BATTERIES (NOT INCLUDED)
5. **RESET BUTTON**
6. **SECURITY CABLE SLOT**
7. **LOCK LATCH**
8. **VAULT DOOR**
9. **MOUNTING HOLE**
10. **BACKUP KEYS (2)**
11. **MOUNTING HARDWARE**
(NOT SHOWN)

*NOTE: Due to ongoing product development, parts are subject to change without notice.
Contact Customer Care if parts are missing when unpackaging the product.*

CONNECTING TO POWER

The vault requires a power source to operate the locking mechanism - AC power or batteries.

- When powered by the AC power cable, the vault is constantly at the ready. Plug in a power cable (not included) into the power cable port at the back of the vault. The constant power source means the device will bypass using the batteries for use.

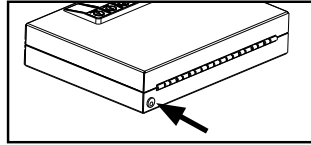

- When AC power cable is not available, the vault can be powered by four AAA batteries.
 1. First, use a backup key to open the vault door.
 2. Locate the battery compartment and remove the screw and cover using the tool supplied.
 3. Insert four AAA alkaline batteries (not included) into the battery compartment. When the batteries are inserted, you will hear a short beep. This confirms correct installation.
 4. Close the cover and secure the screw, or leave the cover off if programming next.

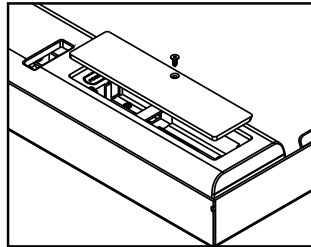

NOTE: IF ALL KEYS LIGHT UP BLUE 10 TIMES WITH 10 BEEPS WHEN OPENING THE SAFE BY USING THE KEYPAD, YOUR BATTERY LEVEL IS CRITICALLY LOW AND YOUR SAFE NEEDS TO BE REPLACED WITH NEW BATTERIES.

Should the vault keypad completely lose power, you can still gain access to the vault by using the backup keys to manually open through the keyhole on the top of the vault.

IMPORTANT: ONLY USE A 6V ADAPTER, HIGHER VOLTAGE WILL DAMAGE THE DIGITAL COMPONENTS.

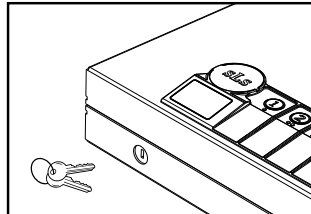

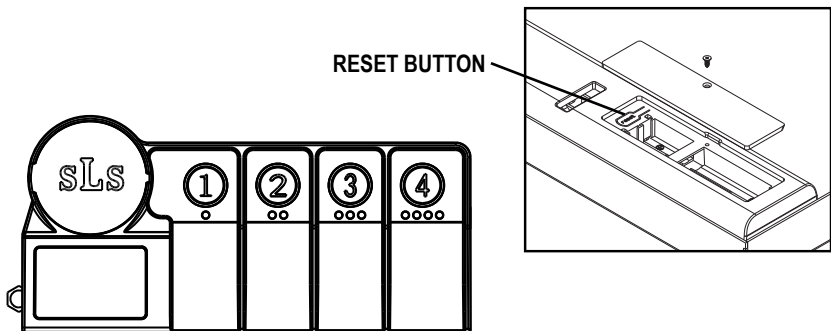

CODE PROGRAMMING

After unpackaging your vault, users should change the default code as soon as possible to prevent unauthorized access to your vault.

NOTE: THE KEYPAD WILL TIME OUT AND SLEEP FOR FIVE MINUTES IF FIVE INCORRECT ENTRIES ARE MADE. THE VAULT CAN STILL BE OPENED BY USING THE BACKUP KEYS OVERRIDE.

1. Enter default code 1-2-3-4 on the keypad to open the vault.
2. Locate the battery compartment and remove the screw and cover using the tool supplied.
3. With the vault and battery compartment open, press and hold the RESET button for three seconds. All keypad keys (1-4) will light up once with one beep.
4. Enter the NEW code.
 - The code can be a minimum of 3 and a maximum of 8 digits.
 - Two keys cannot be pressed simultaneously.

IMPORTANT: ENTERING A NEW CODE WILL OVERRIDE THE PREVIOUS CODE.

5. After entering the new code, press the RESET button once and release it. All keypad keys (1-4) will light up twice with the double beeps, which confirms that the new code has been set successfully.
6. Now test the code: close the door and enter the code. If you have successful programmed the new code, close the cover and secure the screw. If you make a mistake and the new code will not work, use the backup keys to open the vault and program the code again.

NOTE: TO SILENCE THE AUDIBLE SOUND OF THE ELECTRONICS, HOLD THE "1" BUTTON FOR 4 SECONDS UNTIL YOU HEAR ONE BEEP AND ALL KEYS WILL FLASH TOGETHER. TO UNMUTE THE KEYS, REPEAT THIS STEP.

ANCHORING THE VAULT

As the vault size is quite portable, it is strongly recommended that you anchor your vault securely to a floor or wall. Placing a protective barrier (such as a piece of carpet, rubber matting, or wood) between the vault and the floor is beneficial to avoid scratching (leading to rust). Use the mounting screws included to mount your vault to a flat surface using the pre-drilled holes at the bottom.

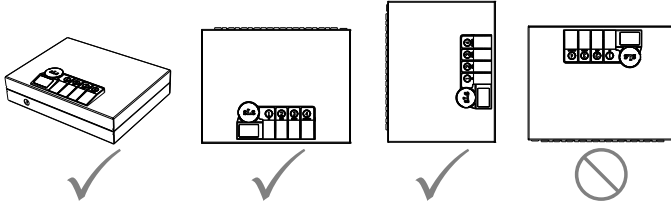

IMPORTANT: MOUNT THE UNIT IN A VERTICAL ORIENTATION SO THAT THE VAULT DOOR FACES DOWNWARD OR TO THE SIDE. IF MOUNTED WITH THE VAULT DOOR FACING UPWARD, THIS WILL RESULT IN FAILURE TO UNLOCK AND OPEN THE VAULT DUE TO WEIGHT COMPENSATION.

1. Measure and position the vault on a flat surface where you want to mount it. Ensure there is enough space to open the vault door. Use a pencil to mark the holes for drilling.
2. Drill pilot holes.
3. Position vault in place and install screws through the inside of the vault, into pilot holes. Tighten screws completely.
4. Test the vault to ensure there is no issue.

USE & MAINTENANCE

Follow these tips to keep your vault in good condition for use and extend its lifetime:

- Do not over-stuff the vault, as this can cause damage to the locking mechanism. Ensure there is no pressure on the vault door when it is closed.
- Remove ammunition from guns before storing in the vault. Ensure they rest securely in their proper cutouts to prevent tipping when the door is closed.
- Use of this product in a very humid environment could interfere with the function of the keypad and locking mechanism. Moisture reducing products, such as a dehumidifier, would be useful to protect your vault, as well as your vault contents, from rust.
- It is recommended to check the batteries in your vault at least once a year. Replace as needed.
- To clean the exterior of your vault, use a soft, non-abrasive cloth dampened with water. Do not use a soaking wet cloth, as this could cause damage to the locking mechanism.
- This vault is not waterproof. If the product is exposed to fire or water, the fire insulation of your vault will be compromised. Should your vault experience either of these conditions, have your vault opened and emptied as soon as possible. If your vault contents includes firearms, remove and have them cleaned and lubricated as soon as possible. Do not continue to store items in a vault that has been compromised by water or fire.

WARRANTY

SureLock Security Company® (“SureLock”, “SureLock Security”, or “SureLock Security Co.”) cabinets, vaults and safes, manufactured by Dansons, carry a limited warranty from the date of sale by the original owner. The warranty coverage begins on the original date of purchase and proof of date of purchase, or copy of original bill of sale, is required to validate the warranty. Customers will be subject to parts, shipping, and handling fees if unable to provide proof of the purchase or after the warranty has expired. This warranty extends to the initial consumer only and is non-transferable.

Dansons carries a three (3) year warranty against defects and workmanship on all parts. Dansons warrants that all part(s) are free of defects in material and workmanship, for the length of use and ownership of the original purchaser. Warranty does not cover damage from wear and tear, such as scratches, dents, dings, chips or minor cosmetic cracks. High temperatures, excessive humidity, water and salt are some of the substances that can affect metal coatings. For these reasons, the warranty does not cover rust or oxidization. This warranty will not apply nor will Dansons assume responsibility if your appliance has not been installed, operated, cleaned and maintained in strict accordance with this owner’s manual. The warranty does not cover damage or breakage due to misuse, improper handling or modifications.

Neither Dansons, or authorized SureLock dealer, accepts responsibility, legal or otherwise, for the incidental or consequential damage to the property or persons resulting from the use of this product. Whether a claim is made against Dansons based on the breach of this warranty or any other type of warranty expressed or implied by law, the manufacturer shall in no event be liable for any special, indirect, consequential or other damages of any nature whatsoever in excess of the original purchase of this product. All warranties by manufacturer are set forth herein and no claim shall be made against manufacturer on any warranty or representation.

Some states do not allow the exclusion or limitation of incidental or consequential damages, or limitations of implied warranties, so the limitations or exclusions set forth in this limited warranty may not apply to you. This limited warranty gives you specific legal rights and you may have other rights, which vary from state to state.

USA: (480) 923-9637 | TOLL FREE: 1-877-942-2246
www.surelock-security.com

For all questions, comments, or inquiries,
please contact Dansons directly. Our
Customer Care department is available for
technical assistance.

USA: (480) 923-9637
TOLL FREE: 1-877-942-2246



WARNING: THIS PRODUCT CAN EXPOSE
YOU TO CHEMICALS INCLUDING DI (2-ETHYLHEXYL)
PHTHALATE (DEHP) WHICH IS KNOWN TO THE
STATE OF CALIFORNIA TO CAUSE CANCER AND
BIRTH DEFECTS OR OTHER REPRODUCTIVE
HARM. FOR MORE INFORMATION GO TO:
WWW.P65WARNINGS.CA.GOV

SURELOCK-SECURITY.COM



MADE IN CHINA
© 2022 DANSONS
602220803UMV