

REVISIONS			
REV	DESCRIPTION	DATE	BY

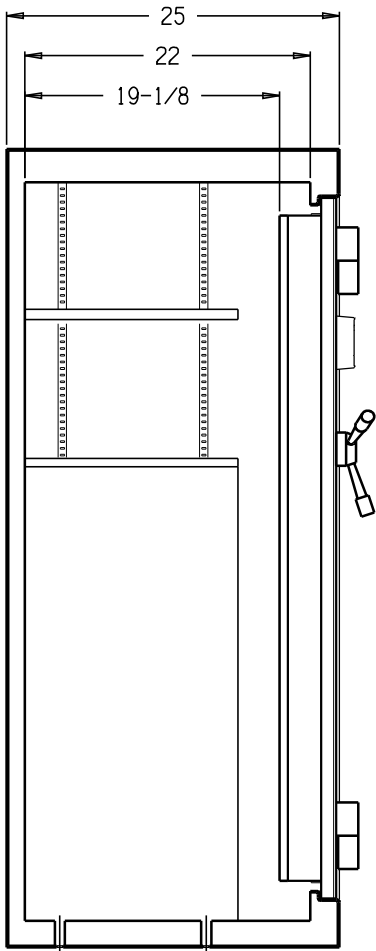

SECTION VIEW

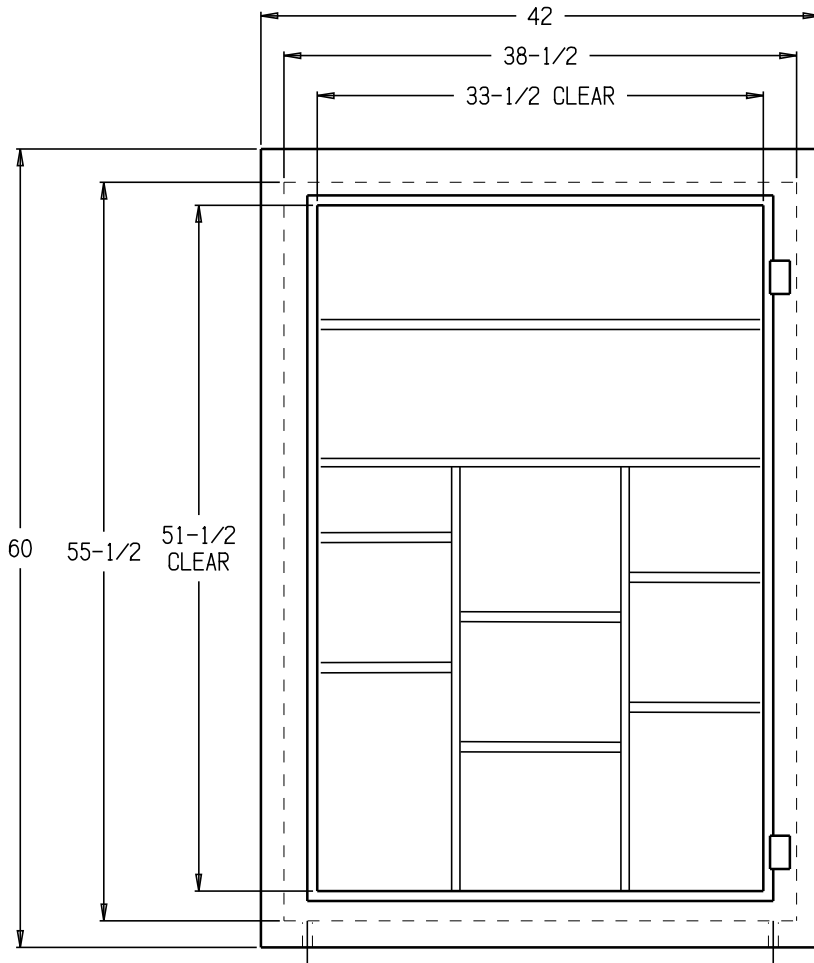

FRONT VIEW
(SHOWN WITHOUT DOOR)

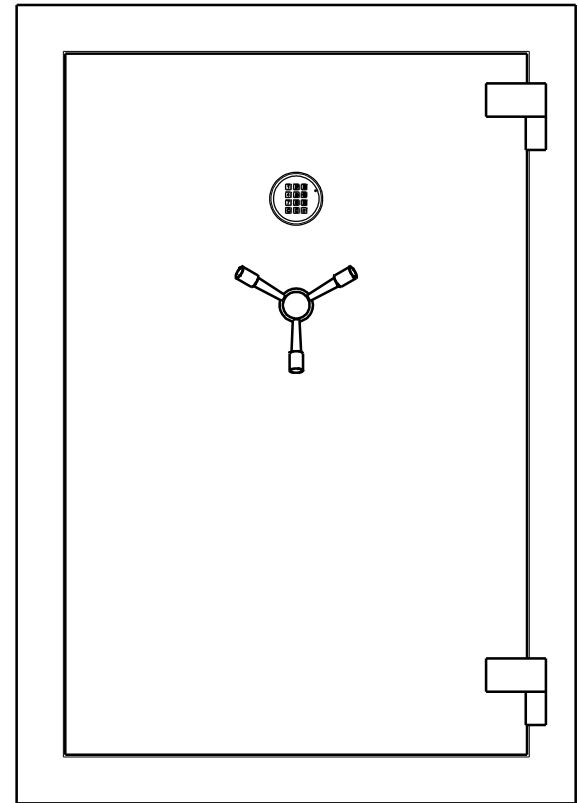

FRONT VIEW

CUSTOMER SIGNATURE					
CUSTOMER NAME					
DATE					
COMPANY NAME					
<small>PROPRIETARY INFORMATION UNAUTHORIZED RELEASE WITHOUT EXPRESS WRITTEN PERMISSION OF AMERICAN SECURITY PRODUCTS CO. EXPRESSLY PROHIBITED</small>		ML # FV6042E5	B Q #	SK2016-551	-
DRAWN R. Tucker	06 JUL 16	SCALE 1/10	DO NOT SCALE DWG	SHEET 1 OF 3	

FV6042 Gun Safe

REVISIONS			
REV	DESCRIPTION	DATE	BY

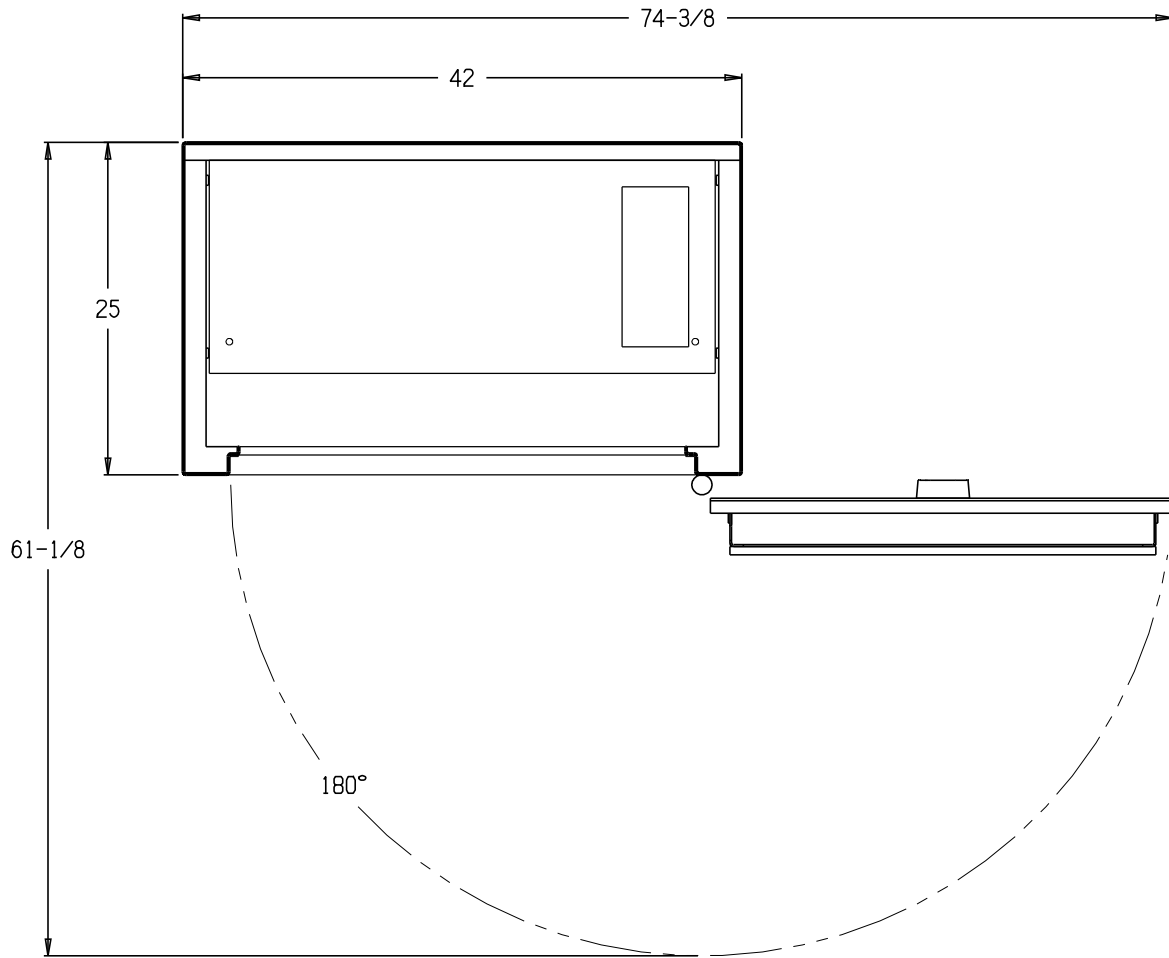

PLAN SECTION VIEW
TOP SHELF

CUSTOMER SIGNATURE			 FV6042 Gun Safe	
CUSTOMER NAME				
DATE				
COMPANY NAME				
PROPRIETARY INFORMATION UNAUTHORIZED RELEASE WITHOUT EXPRESS WRITTEN PERMISSION OF AMERICAN SECURITY PRODUCTS CO. EXPRESSLY PROHIBITED	ML # FV6042E5	B Q #	SK2016-551	-
DRAWN R. Tucker	06 JUL 16	SCALE 1/10	DO NOT SCALE DWG	SHEET 2 OF 3

REVISIONS			
REV	DESCRIPTION	DATE	BY

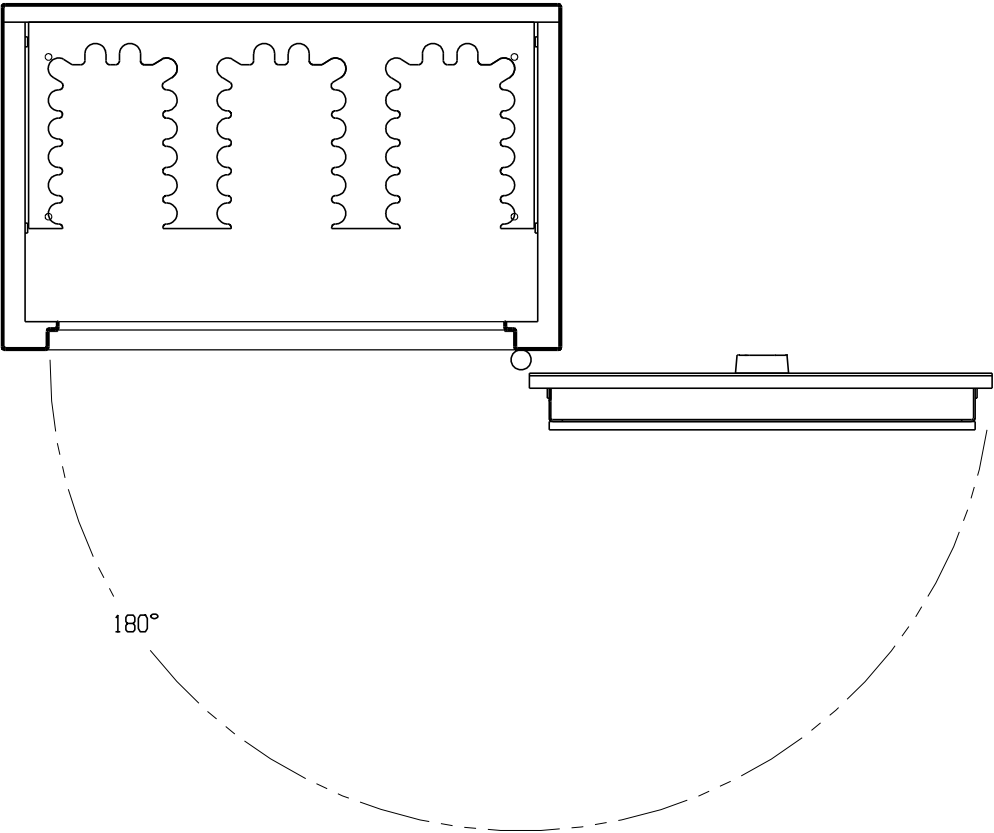

PLAN SECTION VIEW
RACK

SPECIFICATIONS

1. Safe, 60 H x 42 W x 25 D, Outside, UL Listed Residential Security Container, Burglary Class "B". Independent Factory 350° - 45 Min. Fire Rating.
2. Chest, 55-1/2 H x 38-1/2 W x 22 (19-1/8 Clear) D, Inside, Constructed with 1/8" Thick Steel, with a 14-14-14-28-42 + 2 on PDD Interior.
3. Door Outside, Clear Opening: 51-1/2 H x 33-1/2 W. Constructed of 3/16" Thick Steel. Equipped with a UL Listed AMSEC ESL5 Electronic Keypad Combination Lock, Chrome Tri-Spoke Handle and Nine (9) 1-1/4" Dia. Chrome-Plated Locking Bolts (Five (5) Dead Bolts) with Three-Way Boltwork. Lock Protected by a Drill-Resistant Hardplate.
4. Safe Provided with Four (4) Anchor Holes with Hardware and One (1) Electrical Access Hole.
5. Approx Weight: 836 lbs.

CUSTOMER SIGNATURE				
CUSTOMER NAME				
DATE				
COMPANY NAME				FV6042 Gun Safe
PROPRIETARY INFORMATION UNAUTHORIZED RELEASE WITHOUT EXPRESS WRITTEN PERMISSION OF AMERICAN SECURITY PRODUCTS CO. EXPRESSLY PROHIBITED	ML # FV6042E5	B Q #	SK2016-551	-
DRAWN R. Tucker	06 JUL 16	SCALE 1/10	DO NOT SCALE DWG	SHEET 3 OF 3