



Fingerprint Gun Security Cabinet / RPFGR Series
Instruction Manual

Thank You for Your Recent Purchase

At RPNB Safe, we believe that everyone should have access to high-quality protection where they need it most. Whether you're looking to protect your most cherished people or possessions, we are here to help you find the right safe for your needs.

Our mission is simple: Create a safer world.



www.rpnbsafe.us



@rpnbsafe



@RPNBsafe



RPNB SAFE

Scan the QR code for more product information and events

FR Series

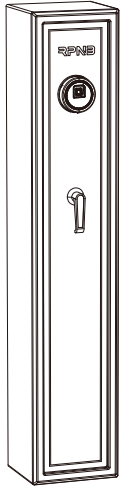

RP3FR : 3-Gun

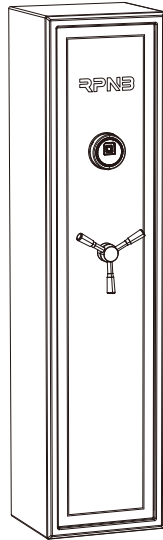

RP5FR : 5-Gun

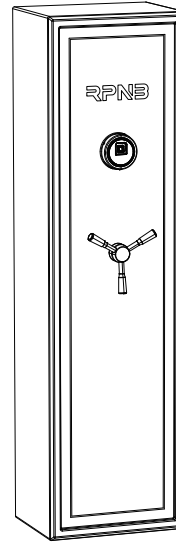

RP7FR : 7-Gun

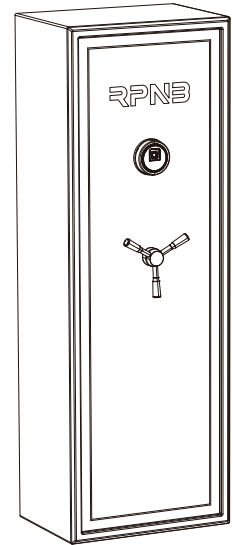

RP10FR : 10-Gun

Box Contents(Take RP7FR as an Example)

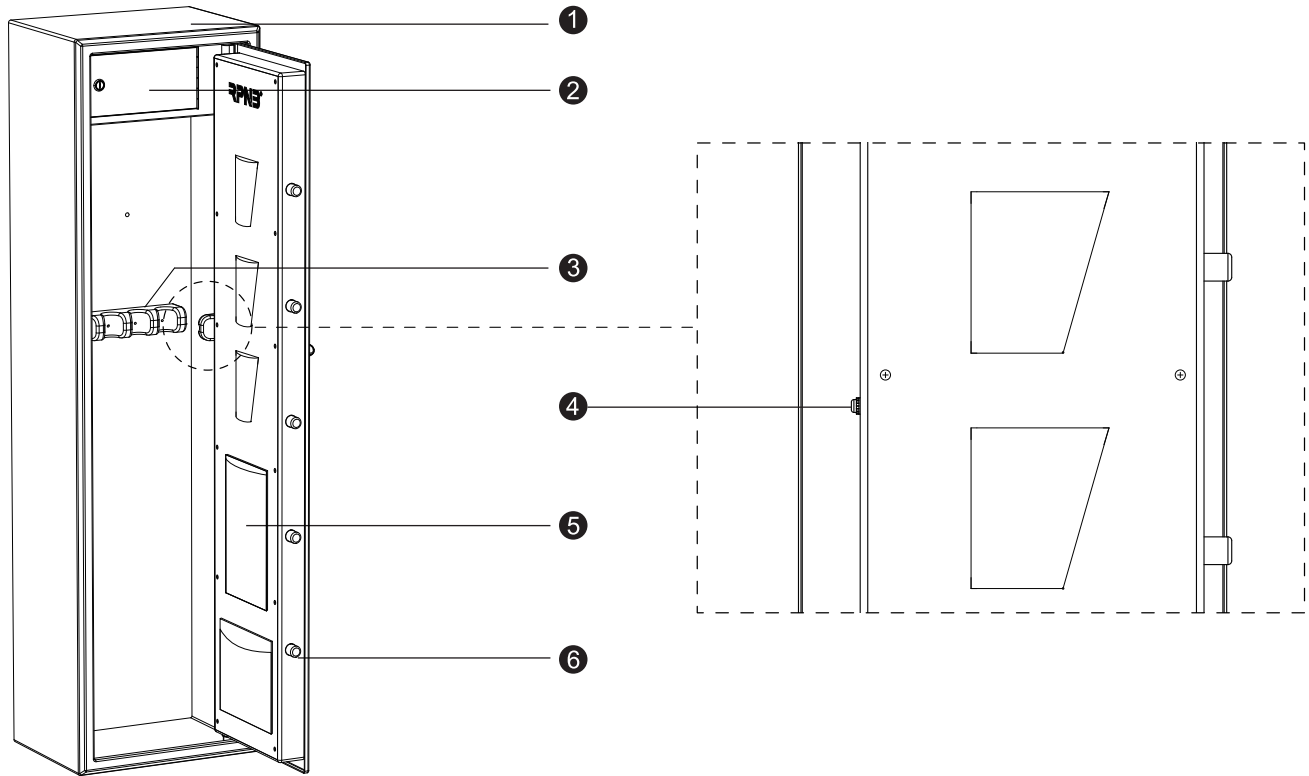

- 1 RPNB® Fingerprint Gun Security Cabinet
- 2 Ammo Cabinet (RP5FR/RP7FR/RP10FR)

- 3 Gun Rack
- 4 Program Button

- 5 Door Organizer
- 6 Living Bolts

Box Contents

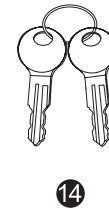
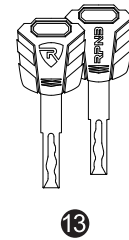
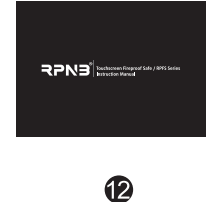
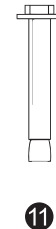
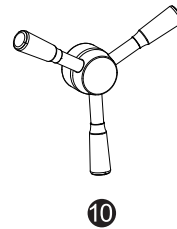
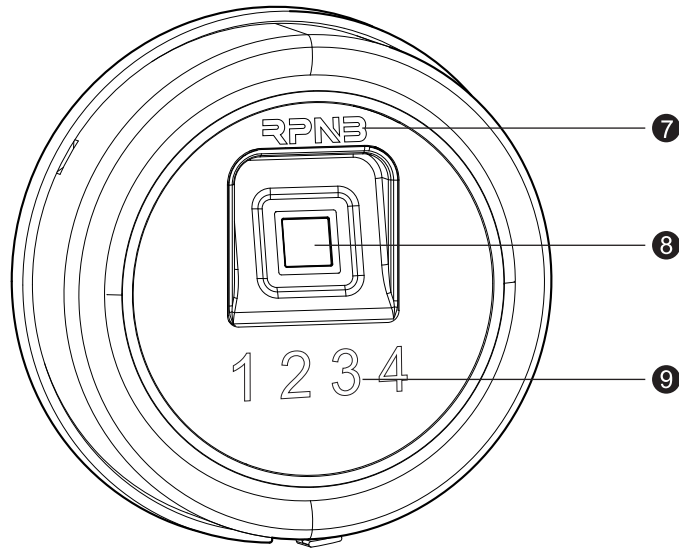

- 7 Indicator Light
- 8 Fingerprint Sensor
- 9 Backlit Keypad
- 10 Handle Spoke

- 11 Expansion Bolts
- 12 Instruction Manual
- 13 Backup Keys for Gun Security Cabinet (2)
- 14 Backup Keys for Ammo Cabinet (2) (RP5FR/RP7FR/RP10FR)

Warning

To prevent damage to your RPNB® unit or bodily injury, read the following safety precautions before using this unit.

**DO NOT PLACE OR STORE THE BACKUP KEYS INSIDE THE SAFE AT ANY TIME.
IF THE BATTERY FAILS, YOU WON'T BE ABLE TO OPEN THE SAFE.**

DO NOT expose to extreme heat or cold. Battery power may be affected.

DO NOT store loaded guns in this unit. Firearms are serious in nature and must be handled with respect. Store responsibly.

ALWAYS check to make sure the safe is closed and locked when it is not in use.

Disclaimer

Neither seller nor manufacturer shall be liable for unauthorized access, any injury, loss or damage to personal property direct or consequential, arising out of the use of, or the inability to use the RPNB® Safe.

The user shall determine the suitability of the RPNB® Safe before the intended use and user assumes all risk and liability whatsoever in connection therewith, RPNB® Safe are not intended to protect against environmental hazards including fire and water.

Be sure and follow all local and state firearm laws.

DO NOT operate a firearm without proper training and experience.

Opening the Safe with the Backup Key

- 1 Locate the handle spoke in the small box hanging on the front door foam, mount 3 spokes to the handle hub.
- 2 Press the tab left and turn the lock cover counterclockwise. (see Figure A-1)
- 3 Insert one of your backup keys into the keyhole, turn it counterclockwise (see Figure A-2), at the same time turn the door handle counterclockwise to open the door. (see Figure A-3)

FIGURE A-1

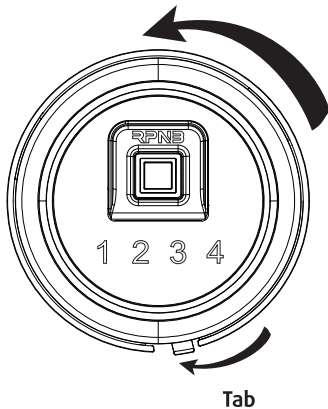

FIGURE A-2

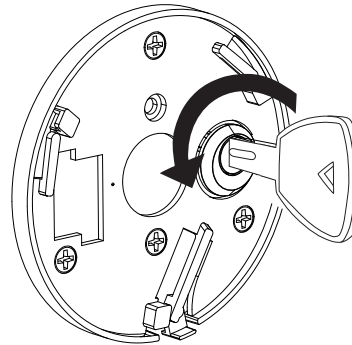
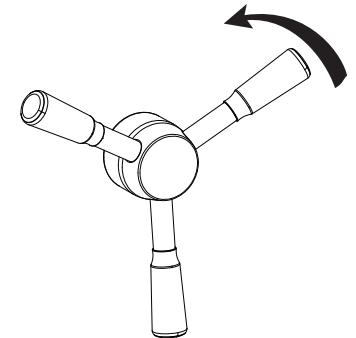

FIGURE A-3



Battery Installation

- 1 With the lock cover remove, locate the battery compartment.
- 2 Connect a 9V alkaline battery (not included) to the battery connecting cap matching the polarity (+/-) indicated. (see Figure B)
- 3 When the battery is connected correctly, the indicator light will light up once with 1 beep.
- 4 Place the lock cover, turn it clockwise back into its original position. (see Figure C)

FIGURE B

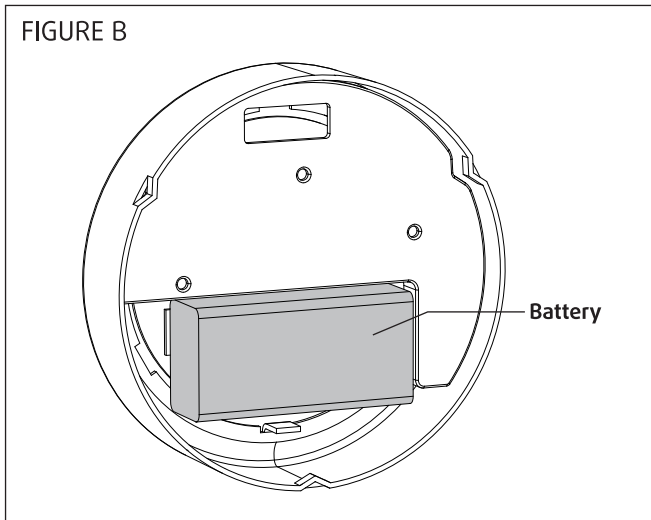
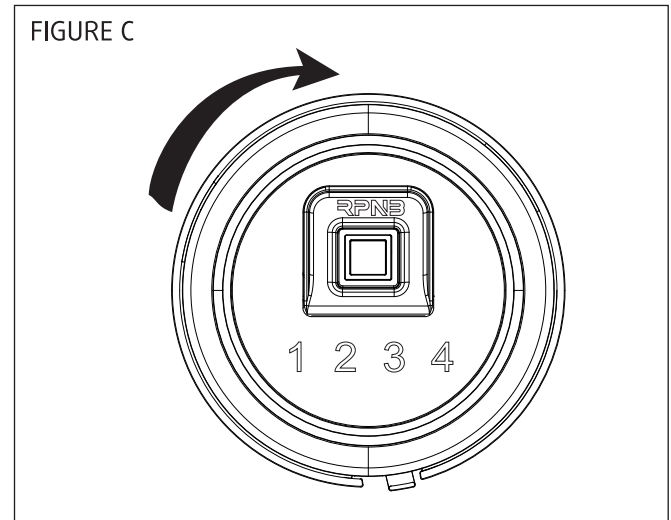

FIGURE C



NOTE:

When changing the battery, always hold the battery connecting cap while disconnecting or attaching the battery. Do not pull on the wires.

Master Code Programming

First time users should change the default code as soon as possible to prevent unauthorized access to your safe. The code should be kept confidential.

Tips: Code Requirements

- Programming a new code will overwrite your previous code.
- Your code can be a minimum of 4 and a maximum of 6 digits.
- Two keys cannot be pressed simultaneously.
- Press anyone of "1,2,3,4" symbols until all keys (1-4) lights to wake up the system before entering your passcode.

- 1 To get started, wake up the system and enter default code 1-2-3-4 on the keypad to open your safe.
- 2 With the safe open, press the Program Button once and release it, the indicator light will light up BLUE once with 1 beep. (see Figure D)
- 3 Enter your NEW master code.
- 4 Press the Program Button once and release it, the indicator light will light up BLUE 2 times with 2 beeps.
- 5 Now test the passcode after woke up the system. If you set the passcode unsuccessfully, the indicator light will light up RED 5 times with 5 beeps, and the new code will not work. You must repeat the above steps to reset the code.

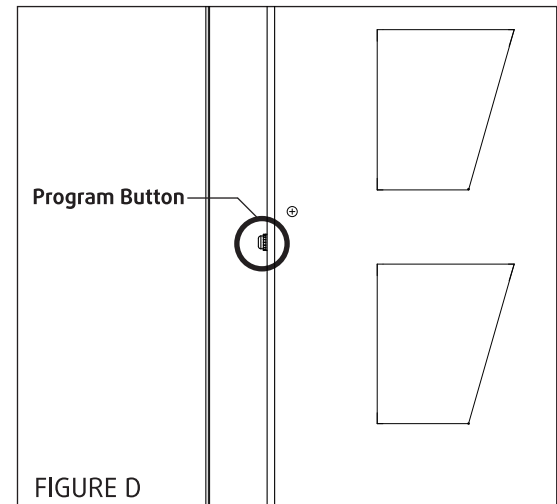

Fingerprints Registering

- 1 With the safe open, press the Program Button once and release it, the indicator light will light up BLUE once with 1 beep. (see Figure E)
- 2 Place your finger on the fingerprint sensor for the 1st of 4 scans. Remove your finger after the indicator light lights up BLUE once with 1 beep. Place your finger again over the fingerprint sensor until the indicator light lights up BLUE once with 1 beep. You will repeat this process until the indicator light lights up BLUE 2 times with 2 beeps.
- 3 Now your fingerprint has been successfully registered.
- 4 Test your fingerprint. If you register the fingerprint unsuccessfully, the new fingerprint will not work. You must repeat the above steps to re-register your fingerprints.

NOTE :

- You cannot register more than 20 fingerprints. If the indicator light lights up RED 5 times with 10 beeps when you register your fingerprint, it means the fingerprint storage capacity is full.

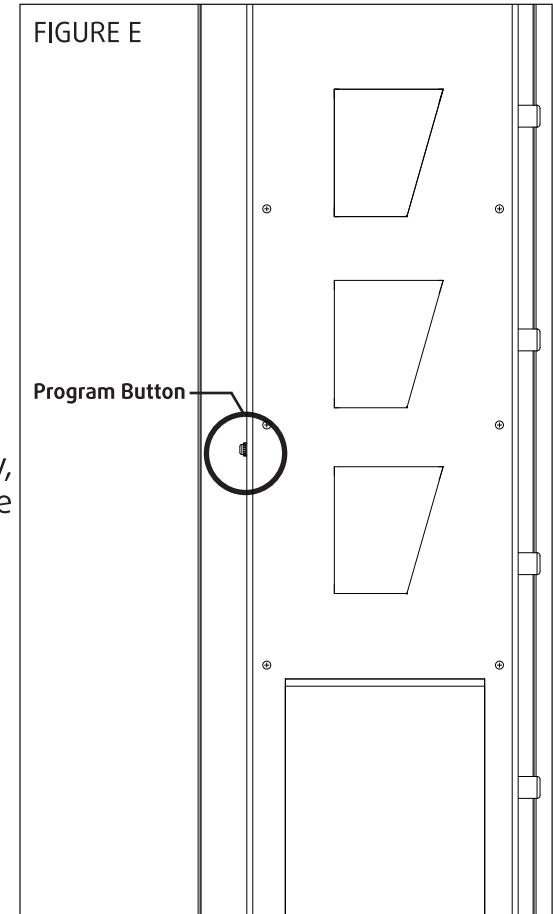

Fingerprints Registering

Helpful Programming Tips:

- 1 place your finger on the center of the sensor (this allows the sensor to read where most of the fingerprint detail is located).
- 2 Adjust your finger slightly between scans for increased accuracy.
- 3 Excessive moisture, lotion, or dirt will affect your fingerprint and may cause inaccurate sensor reading.
- 4 If you are experiencing difficulty try different fingers. Each finger is unique, and some fingers such as your thumb, contain more readable information than others.
- 5 To increase your success rate, please register the same fingerprint multiple times.

FIGURE F

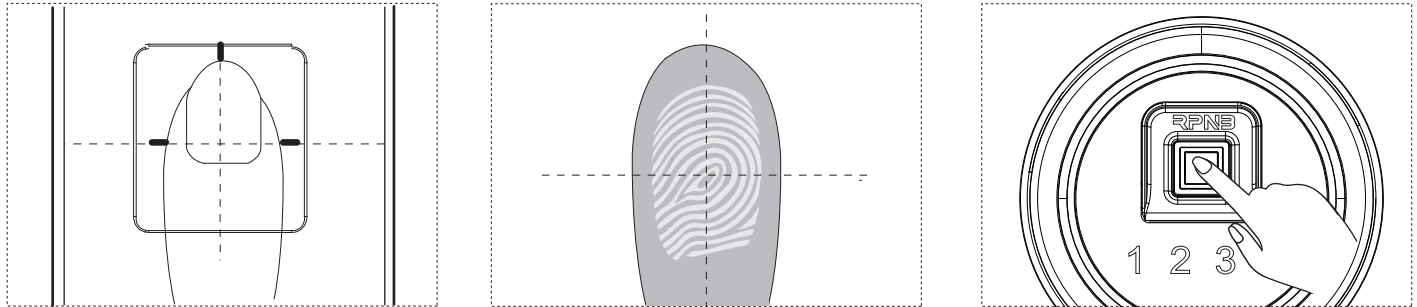

Registered Fingerprints Deleting

- 1 Press and hold the Program Button until the indicator light lights up BLUE 2 times with 2 beeps.
- 2 Now all previously registered fingerprints are erased.

Lock-Down System

- If you enter the wrong code or unregistered fingerprints, the indicator light will light up RED 5 times with 5 beeps.
- If the wrong code or unregistered fingerprint is entered 5 consecutive times, the safe will go into a lock-down mode for 5 minutes.
- During this time the indicator light will keep flashing RED, the keypad and fingerprint sensor will be temporarily disabled.
- The safe can still be opened by using the backup keys override.
- After 5 minutes, the safe will automatically resume normal operation.

Low Battery Warning

If the indicator light lights up BLUE 1 second, and then lights up RED 10 times with 10 beeps when opening the safe by electronic way, your battery level is critically low and your safe needs to be replaced the new battery.

Vibration Alarm Setting

Press and hold the number “4” for 4 seconds until you hear 1 beep and the indicator light lights up together.

NOTE:

- During the alarm, the keypad and fingerprint sensor will be temporarily disabled, the safe can still be opened by the backup keys or you can reinsert the battery.
- After the alarm is deactivated, you need to reset the above steps.

Locking the Safe

Turn the door handle clockwise to close the door.

Silence Mode Setting

To silence the audible sound of the electronics, hold the number “1” for 3 seconds, until the indicator light lights up. To unmute the keys, repeat this step, you will hear 1 beep and the indicator light lights up together.

Securing Your Safe

There are some mounting screws included to mount your RPNB® safe to a flat surface using the pre-drilled holes on the bottom.

Using the Mounting Screws

TIP: Make sure you have enough clearance for the lid to open properly before mounting the safe.

- 1 Position the safe on a flat surface where you want to mount it.
- 2 Use a pencil to mark the holes for drilling.
- 3 Drill pilot holes.
- 4 Position safe in place and install screws through safe into pilot holes. Tighten screws.

IMPORTANT:

Use the expansion bolt when there is a concrete wall surface. Use the clamping screw when there is a wooden wall surface.

How shall I view tutorial videos?



RPNB[®]
<http://www.rpnbsafe.us>

- 1 Go to our website via: **www.rpnbsafe.us**
- 2 Select "**Support**" on footer navigation bar
- 3 Click "**How to Use**"
- 4 Click the **Product Model** you purchased

How shall I replace keys?

- 1 Go to our website via: **www.rpnbsafe.us**
- 2 Select "**Support**" on footer navigation bar
- 3 Click "**Replace Keys**"
- 4 Fill in the required information

How shall I order accessories?

- 1 Go to our website via: **www.rpnbsafe.us**
- 2 Select "**Support**" on footer navigation bar
- 3 Click "**Accessories**"
- 4 Select the product model you purchased

 More online at www.rpnbsafe.us under support

Customer Support/Warranty

Customer Support

If you have a problem with your RPNB® safe that is not answered in the this manual, we encourage you to email us: CUSTOMERSUPPORT@RPNBSAFE.COM

Linked Warranty (Terms and Conditions)

RPNB® is committed to building high quality products and will make every effort to ensure our products are free from any defects. We guarantee your safe will be free of defects in materials or workmanship for a period of one year from the date of purchase. This warranty does not cover abuse, misuse, use in any manner for which is not designed, neglect, modification, damage inadvertently caused by the owner, accidents, and/or tampering.

If your safe is determined to be defective and we are responsible for the cause we will have it repaired at our expense, or we will send a new replacement at no cost to you. You will be required to return your existing unit as well as all included accessories to RPNB® prior to replacement of the defective unit along with your proof of purchase.

If it is determined your safe needs to be returned, our customer support team will provide you with a return details.

Please have the following information available when contacting us:

- Purchaser's name and mailing address, email address, and phone number
- Online order number
- Detailed description of problem

HOW TO CONTACT?

Go to Your Orders, find your order in list, and click get product support.

You can e-mail the seller by doing the following:

Account&Lists Orders Try

Your Account

- Your Account
- Your Orders** ←
- Your Dash Buttons
- Your Lists

Your Orders

Orders Open Orders Digital Orders

1 order placed in past 6 months

Get product support →

- Write a product review
- Archive order



Talk to an expert

Figure out and fix what' s wrong,get

- phone
- chat** →

if a new window doesn' t appear,chan

- 1.Go to your account find the order
- 2.Find your order item
- 3.Click get product support
- 4.Give the seller 24hours to respond

-  Please email us to get a special **VIP** discount code before your next order.
-  Problem with the order? Please email us, give us a chance to help you first.
-  Do you love your new RPNB product? Help others find it by leaving a product review online !



RPNB

Ver 1.02