

**WICHTIG:**  
Vor Gebrauch  
lesen

**IMPORTANT:**  
Read before  
using

**IMPORTANTE:**  
Lea antes de  
usar

**IMPORTANT:**  
Lire avant  
usage

**IMPORTANT:**  
leggere prima  
dell'uso

**BELANGRIJK:**  
lees voor  
gebruik

**VIKTIG:**  
Les før du  
bruker

**VIKTIGT:**  
Läs innan du  
använder

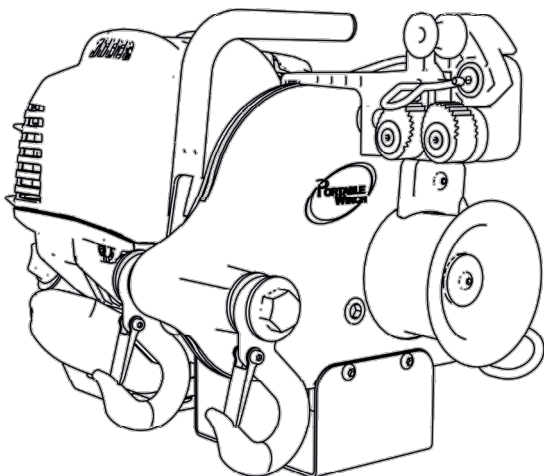
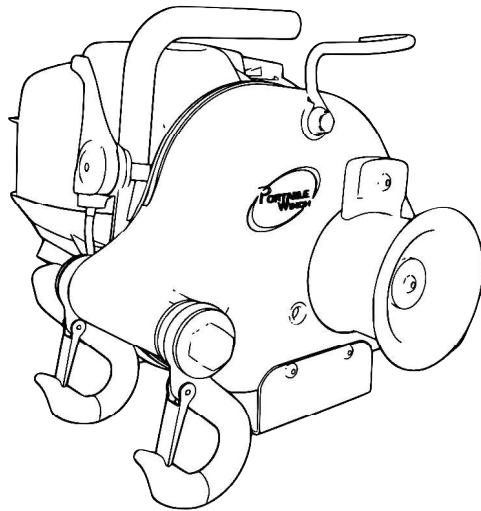

# PCW3000 PCW4000 USER GUIDE



DE  
EN  
ES  
FR  
IT  
NL  
NO  
SV



**Betriebs-/Sicherheitshinweise**  
**Operating/safety Instructions**  
**Instrucciones de operación / seguridad**  
**Consignes de fonctionnement/sécurité**  
**Istruzioni per l'uso e la sicurezza**  
**Gebruiksaanwijzing / Veiligheidsvoorschriften**  
**Bruksanvisning / sikkerhet**  
**Bruksanvisning / säkerhet**

[www.portablewinch.com](http://www.portablewinch.com)

**WICHTIG:**  
Vor Gebrauch  
lesen

**IMPORTANT:**  
Read before  
using

**IMPORTANTE:**  
Lea antes de  
usar

**IMPORTANT:**  
Lire avant  
usage

**IMPORTANT:**  
leggere prima  
dell'uso

**BELANGRIJK:**  
lees voor  
gebruik

**VIKTIG:**  
Les før du  
bruker

**VIKTIGT:**  
Läs innan du  
använder

**INTRODUCTION**

Portable Winch Co. thanks you for purchasing a Portable Capstan Winch™. This manual was written to help you make the best use of your new machine and to use it in the most secure way.

**PLEASE READ CAREFULLY BEFORE USE**

For any problems or questions please refer to an authorized Portable Winch Co. dealer or contact us directly.

**1 Safety guidelines**

Portable Capstan Winches™ are designed to pull objects generally at angles of more or less 45 degrees relative to the horizontal. The use of a winch may present serious risks of injury, property damage or even death.

**DO NOT UNDERESTIMATE THE POTENTIAL DANGERS**

**1.1 Safety messages**

Your safety and the safety of others are very important. You will find important safety messages in this manual. **Please read them carefully.**

These safety messages are warning you of potential injuries to either yourself or others. Each safety message is preceded by a warning symbol.

SYMBOL	MEANING
	YOU WILL BE MORTALLY OR SEVERELY INJURED IF YOU DO NOT FOLLOW THESE INSTRUCTIONS.
	YOU COULD BE MORTALLY OR INJURED IF YOU DO NOT FOLLOW THESE INSTRUCTIONS.
	YOU COULD BE INJURED IF YOU DO NOT FOLLOW THESE INSTRUCTIONS.
	READ THE USER GUIDE
	HEARING PROTECTION
	EYE PROTECTION
	WEAR GLOVES
	RISK OF HAND TRAPPING

SYMBOL	MEANING
	RISK OF HAND INJURY
	DO NOT USE FOR LIFTING

**1.2 Labels**

**1.2.1 Serial number labels**

The serial number label can be found on the right side of the machine's gearbox. In addition to the serial number, the fundamental specifications of your model are also found there.

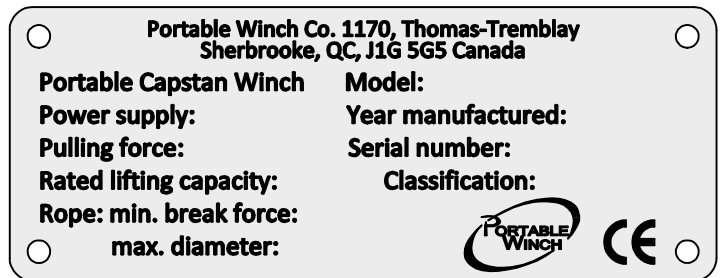

**1.2.2 Multi icon label**

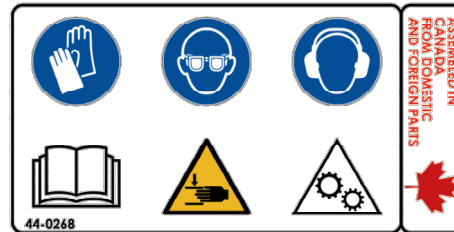

This label is located on the winch housing. It contains the safety icons and should be cleaned or replaced if it becomes dirty, damaged or torn off. **44-0268**

**1.2.3 Label "DO NOT USE FOR LIFTING"**



This label is located on the winch housing. It indicates that the winch is not intended for lifting operations. **44-0269**

**1.2.4 Line installation label**

The label is placed on the housing. This label is placed on the winch's housing. It indicates the installation direction of the line for the Portable Capstan Winch™.



PCW3000

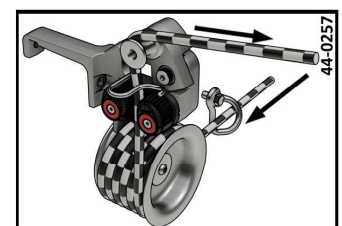

PCW4000

## 1.3 Safety information

**PRECAUTION** DO NOT ALLOW CHILDREN TO USE THE PORTABLE CAPSTAN WINCH™. KEEP CHILDREN AND ANIMALS OUTSIDE OF THE WORK ZONE.

**ATTENTION** NEVER ALLOW AN UNTRAINED PERSON TO USE THE PORTABLE CAPSTAN WINCH™. MAKE SURE THAT THIS PERSON IS AWARE OF THE SAFETY INSTRUCTIONS AND HAS READ THIS MANUAL AS WELL AS THE HONDA ENGINE USER MANUAL.

**ATTENTION** INFORM ALL USERS OF THE SAFETY AND USAGE INSTRUCTIONS.

**ATTENTION** FAMILIARISE YOURSELF WITH THE OPERATION OF THE PRODUCT AND THE SAFETY INSTRUCTIONS BEFORE YOU START TO WORK WITH THE PORTABLE CAPSTAN WINCH™.

**ATTENTION** ENSURE THAT YOUR CLOTHING IS CLEAR FROM THE MOVING PARTS OF THE MACHINE.

**DANGER** THE ENGINE EXHAUST GASES CONTAIN POISONOUS CARBON MONOXIDE. NEVER RUN THE ENGINE IN A CLOSED BUILDING WITHOUT ADEQUATE VENTILATION.

**PRECAUTION** CLEAN AND/OR REPLACE ALL SECURITY LABELS THAT ARE DIRTY, DETERIORATED, UNREADABLE OR TORN.

**ATTENTION** ALWAYS KEEP ONLOOKERS OUTSIDE OF THE WORK ZONE.

**DANGER** NEVER PULL ROLLING MATERIAL THAT RISKS ROLLING OUT OF YOUR CONTROL.

**ATTENTION** THE PORTABLE CAPSTAN WINCH™ IS NOT DESIGNED TO LIFT LOADS OR PEOPLE.

**PRECAUTION** WE RECOMMEND THAT YOU WEAR HEARING PROTECTION DURING USE.

**ATTENTION** ALWAYS KEEP VISUAL CONTACT BETWEEN THE USER AND THE SPECTATORS TO ENSURE GOOD COMMUNICATION.

## 2 Checks before use

### 2.1 On receiving

Inspect the box to detect any obvious damage. If a part is missing or damaged, notify the carrier immediately.

### 2.2 Is the engine ready?

#### 2.2.1 Oil the engine

Fill the Honda engine with SAE 10W-30 API SJ oil according to the quantities indicated for your model.

- PCW3000 : 100 ml
- PCW4000 : 130 ml

Check the oil level before each use on a horizontal surface. The oil level should rise to the edge of the opening. Add oil if necessary. For special uses and in extreme temperature conditions, refer to the Honda engine owner's manual.

If the oil level exceeds the maximum level, there could be an excessive amount of contaminants such as unburned fuel and condensed water vapor. Drain and change the oil.

### 2.2.2 Gasoline

Fill the tank with **UNLEADED** gasoline. Never use a mixture of oil/gasoline, your Portable Capstan Winch™ is equipped with a fourstroke engine. Consult the Honda engine manual. Do not over fill.

### 2.2.3 Starting the engine

Consult the Honda engine manual for starting instructions.

**FIRST TIME USE: ALLOW THE ENGINE TO RUN IDLY FOR FIVE (5) MINUTES BEFORE PULLING A LOAD FOR THE FIRST TIME.**

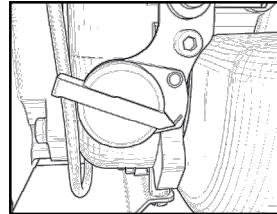

Activate the engine's on/off switch.

Take care to pull the starter grip in the output axis of the rope. If you do not pull at the correct angle, the friction of the rope on the plastic housing may damage the rope and/or the housing.

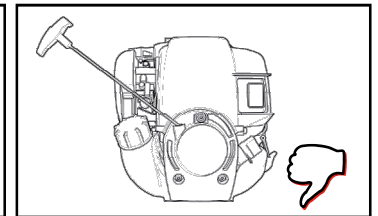
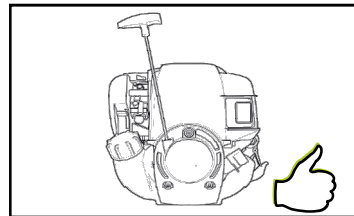

### 2.2.4 Capstan drums

Your Portable Capstan Winch™ is equipped with Drum 76 mm in diameter.

### 2.2.5 Spark arrestors

The PCW3000 and PCW4000 models are fitted with internal spark arrestors.

Consult the Honda engine manual for spark arrestor maintenance instructions.

## 3 Using the winch

**ATTENTION** MOST PULLING SITUATIONS PRESENT **POTENTIAL DANGERS!**

### 3.1 Rope

#### 3.1.1 Type of rope

Only use a line with low elasticity. We recommend a double braid polyester line.

Min., max. and recommended diameters:

- Min : 10 mm
- Max : 12-13 mm
- Recommended : 10 mm

Contact us if you have any questions about rope types.

**⚠ ATTENTION** DO NOT USE A 3-STRAND YELLOW POLYPROPYLENE LINE!

- POLYPROPYLENE AND POLYETHYLENE LINES ARE DANGEROUS FOR PULLING DUE TO THEIR ELASTICITY AND THEIR LOW MELTING POINT.
- MAKE SURE THAT THE LINE IS NOT DAMAGED AND OFFERS ADEQUATE RESISTANCE FOR THE LOAD TO BE PULLED.

**⚠ ATTENTION** STRETCHING = DANGER!

- STRETCHING THE LINE MAY CAUSE SERIOUS INJURY. BE CAREFUL WHEN RELEASING THE TENSION IN THE LINE.
- ALL LINES STRETCH: INCREASED LENGTH: THE MORE THE LINE IS PULLED, THE MORE IT STRETCHES.
- STRETCHING THE LINE MAY CAUSE THE LOAD TO MOVE IN AN UNEXPECTED AND DANGEROUS MANNER.
- STRETCHING THE LINE MAY CAUSE IT TO RELAX AND MOVE BACKWARDS QUICKLY, PULLING YOUR HAND TOWARDS THE WINCH OR CAUSING SEVERE BURNS. NEVER WIND THE LINE AROUND YOUR HAND.

**⚠ PRECAUTION** ALWAYS WEAR GLOVES.

### 3.1.2 Rope maintenance

**⚠ PRECAUTION** PERFORM A VISUAL INSPECTION OF THE LINE BEFORE EACH USE. IF IT SHOWS OBVIOUS SIGNS OF WEAR (STRANDS CUT, EXCESSIVE ABRASION) THEN CHANGE IT.

**⚠ PRECAUTION** IF YOUR LINE IS DIRTY, CLEAN IT. A DIRTY LINE CAN QUICKLY BECOME DAMAGED AND CAUSE PREMATURE WEAR OF PARTS WHICH COME INTO CONTACT WITH IT.

### 3.1.3 Recommended knots

You must attach the load to the end of the line. Although a simple knot may sometimes suffice, we recommend using a bowline knot (fig. 1). This knot holds approximately 70% of the line's capacity while most knots reduce the line's capacity by 50% or more. Additionally, it may be easy to untie even after pulling a heavy load.

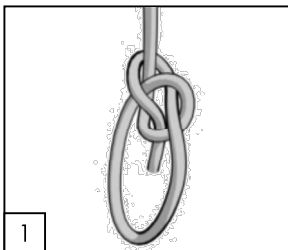

Even better, a double bowline knot (fig. 2) allows you to maintain approx. 75% of the line's capacity.

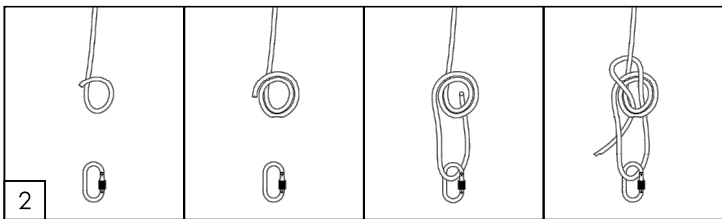

### 3.2 Anchoring the winch

**OPTION 1** : In most cases, the winch is anchored to a fixed object using a polyester sling or one of our optional anchors and the line is attached to the object you are trying to move. The latter is moved towards the winch as the winch pulls the line.

**OPTION 2** : Sometimes, the winch can be anchored to the object you want to move and the line is attached to a fixed object. The winch and the object being moved are then pulled towards the line's anchoring point. This method is useful when you guide the load while operating the winch.

Your winch is supplied with a polyester sling measuring 2 meters. To anchor the winch, wind it around the anchoring point with the sling. Insert each end of the sling in each of the two safety hooks located on the back of the winch (fig. 1).

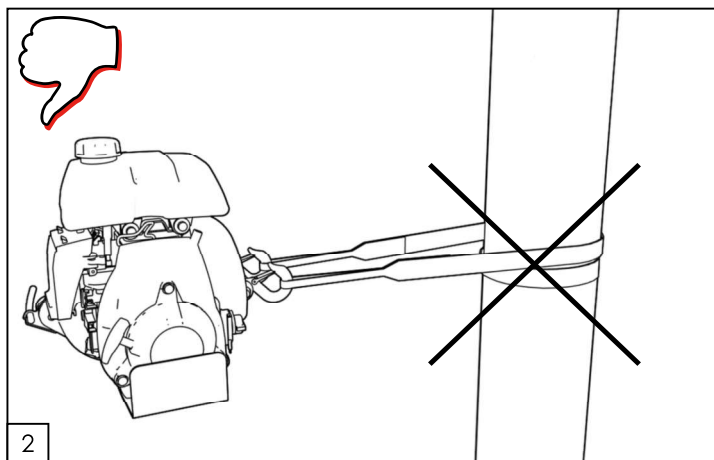
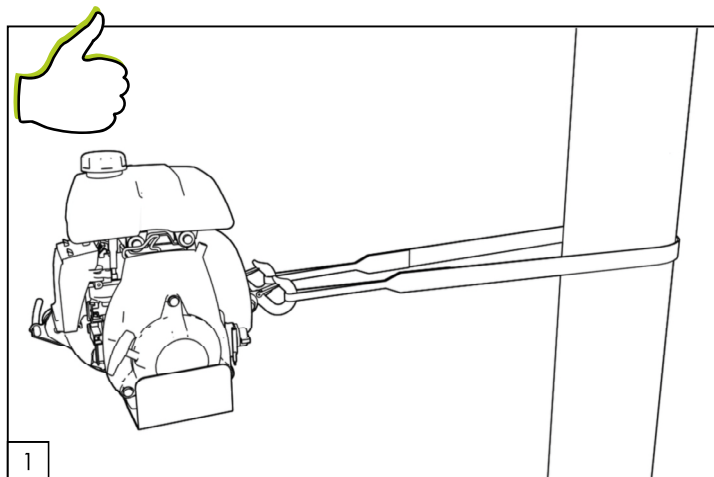

Place the winch in the direction of the load to be pulled. When the winch is switched on, it will attempt to align itself with the load. The friction of the sling against the anchor may prevent correct alignment; in this case, release the tension in the line and move the sling so that the tension is distributed over the two books equally.

**⚠ PRECAUTION** **WHAT NOT TO DO:** WHEN YOU INSTALL THE SLING TO ANCHOR THE WINCH, AVOID A FULL TURN AROUND AN ANCHORING POINT (FIG. 2). THIS WILL PREVENT THE WINCH FROM ALIGNING ITSELF WITH THE LOAD CORRECTLY. THIS WILL ALSO APPLY UNEVEN TENSION TO EACH OF THE HOOKS.

**⚠ PRECAUTION** AVOID INSTALLING THE SLING ON SHARP CORNERS WHICH ARE LIKELY TO DAMAGE THE POLYESTER SLING. WHEN YOU USE A POLE, A TREE OR A STUMP AS AN ANCHORING POINT, INSTALL THE SLING CLOSE TO THE BASE.

**⚠ PRECAUTION** ANCHORING AROUND A STUMP REQUIRES SPECIAL ATTENTION TO AVOID THE SLING SLIPPING OFF THE TOP OF THE STUMP.

**⚠ ATTENTION** ENSURE THAT THE ANCHORING POINT IS ABLE TO WITHSTAND THE WINCHING WITHOUT BREAKING, BEING EXTRACTED OR BECOMING DAMAGED.

We also offer a wide range of anchoring accessories for our capstan winches. Visit [www.portablewinch.com](http://www.portablewinch.com)

### 3.3 Oil level

The Honda GX-35 and GX-50 4-stroke are engines for all positions. Therefore, it can be used at any angle without the engine stopping during operation.



### 3.4 Installing the rope

**ATTENTION** THE CORRECT DIRECTION WHEN DEPLOYING THE LINE IS THE KEY TO THE SAFE USE OF THE WINCH.

The wide range of situations encountered during pulling prevents us from giving specific instructions for all situations; however, you should consider the following points:

#### 3.4.1 Rope

Use a line with a low elasticity in good condition with a minimum diameter of 10 mm and a maximum diameter of 12 -13 mm with good knots. We highly recommend the bowline knot (see section 3.1.3). Use pulleys to divert the line and increase the pulling power when the load approaches or exceeds the winch's pulling capacity.

#### 3.4.2 Pulley

The use of a pulley at a short-distance from the winch offers several benefits:

- Provides an angle allowing the load to be slightly raised to reduce friction;
- Maintains the winch in near horizontal position;
- Keeps the winch and the operator away from the load's trajectory.

#### 3.4.3 Direction

Install the line so that it doesn't rub against any objects during pulling. Try to install the line so that the front of the load is slightly raised. Never pull downwards or through obstacles.

**ATTENTION** IN GENERAL, IF THE LINE TOUCHES THE GROUND DURING PULLING THEN THE SETUP IS INCORRECT.

#### 3.4.4 On a slope

**ATTENTION** DO NOT PULL A LOAD DOWN A SLOPE TOWARDS THE WINCH BECAUSE THE LOAD MAY SLIDE TOWARDS YOU BEFORE YOU CAN STOP IT. IN THIS CASE, USE A PULLEY AT THE BOTTOM OF THE SLOPE AND POSITION THE WINCH FURTHER BACK AWAY FROM THE AXIS OF THE LOAD.

### 3.5 Pulling a load

**ATTENTION** CHECK THE POSITION OF THE WINCH, THE STATE OF THE LINE, THE STRENGTH OF THE ANCHORING POINT, KNOTS, HOOKS AND/OR SHACKLES TO AVOID INJURIES AND MATERIAL DAMAGE.

**ATTENTION** WATCH THE ANCHOR WHILE WINCHING. POSITION YOURSELF TO AVOID BEING HIT IF THE ANCHOR MOVES.

#### 3.5.1 Winding the line around the capstan drum

**ATTENTION** NEVER PLACE YOUR HANDS CLOSE TO THE LINE GUIDE, CAPSTAN DRUM AND ENTRY HOOK (PCW3000) OR GUIDE PULLEY (PCW5000 AND PCW5000-HS) WHEN THE ENGINE IS RUNNING.

1. Start the engine and allow it to run idly for 30 seconds to warm up.
2. Thru entry hook then under the drum.
3. Wrap the line around the drum (3 or 4 turns).
4. a: For the PCW3000 (fig.1), take the line behind the exit hook.  
b: For the PCW4000 (fig.2a), bring the rope behind the rope retention hook and exit guide.
5. Keep your distance from the winch (approx. 1 m) and pull slowly and horizontally on the line until the line's slack is taken up and you feel tension in the line.
6. Inspect your installation to make sure that the anchoring of the winch and the entry hook are aligned with the line.
7. Check that the line is not rubbing against objects in its path.
8. For the PCW3000, increase the engine speed and pull to start winching. For the PCW4000, simply pull the rope to start winching. The pivot of the rope locking system will increase the engine speed.

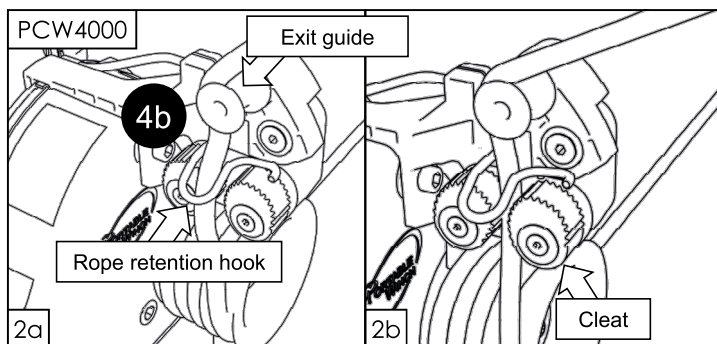
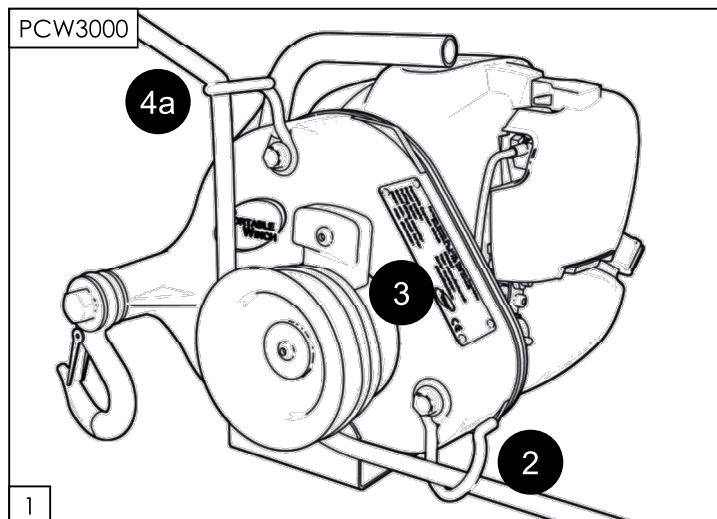

#### 3.5.2 Pulling

When pulling, position yourself so that you can see the winch and the load. Pull on the line **HORIZONTALLY**. The tension you exert on the line keeps the winch level.

**ATTENTION** DO NOT WRAP THE LINE AROUND YOUR HANDS OR YOUR BODY! ALSO, BEWARE OF BUILT-UP TENSION CLOSE TO YOU AND MAKE SURE THAT YOU ARE A SAFE DISTANCE FROM THIS ACCUMULATION.

**ATTENTION** KEEP AN EYE ON THE CAPSTAN DRUM DURING OPERATION AND MAKE SURE THAT THE LINE DOES NOT CROSS THE LATTER. IF THIS OCCURS, RELEASE THE TENSION IN THE LINE, STOP THE ENGINE AND REMOVE THE KINK.

##### 3.5.2.1 If the line slips

If the line slips on the drum while you are pulling, add a turn of line around the drum (4th turn). The engine will stall when the winch reaches its maximum capacity (PCW3000). You should then review the installation (add pulleys) or "cradle" the load (see next section).

### 3.5.2.2 To "cradle" the load

PCW3000: Pull until the engine nearly stalls and release the tension in the line. Then return the tension to the line and repeat as required.

PCW4000: Release the rope. The rope locking system will keep tension on the load. To release the tension, disengage the rope from the cleat and SLOWLY release the tension.

**PRECAUTION** BE CAREFUL WHEN USING THE LOAD "CRADLING" METHOD. THIS METHOD MAY CAUSE RAPID WEAR TO THE LINE DUE TO THE HEAT CREATED ON THE DRUM.

**ATTENTION** IF THE WINCH PULLS THE LINE AND THE LOAD DOESN'T MOVE (OFTEN WHEN A VERY LONG LINE IS BEING USED), THE LINE STRETCHES AND THE BREAKING POINT MAY BE REACHED CAUSING IT TO SUDDENLY COME BACK ON TO YOU. SLOWLY RELEASE THE TENSION IN THE LINE BUT BEWARE OF THE BUILT-UP TENSION: THE LINE MAY QUICKLY GET AWAY FROM YOU CAUSING BURNS OR TAKING YOU TOWARDS THE WINCH.

### 3.5.2.3 Taking a break during pulling

PCW3000: **SLOWLY** release the tension in the line and allow it to slide over the drum.

PCW4000: Release the rope. The rope locking system will keep tension on the load. To release the tension, disengage the rope from the cleat and **SLOWLY** release the tension.

**PRECAUTION** NEVER ALLOW THE LINE TO SLIDE ON THE DRUM FOR MORE THAN A FEW SECONDS WHEN LOADED - THE HEAT GENERATED BY THE FRICTION MAY MELT OR DAMAGE THE LINE.

### 3.5.2.4 If it is essential to keep the tension in the line at startup

PCW3000: You can use a blocker or a Prusik knot connected to your anchoring point to maintain the tension in the line. You can also use a self-locking pulley PCA-1271 or PCA-1272. They are particularly useful for pulling rolling objects and for directional felling.

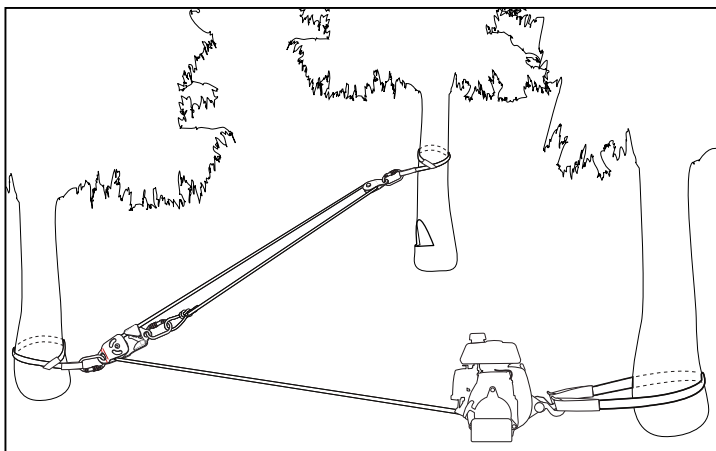

PCW4000: The PCW4000 is equipped with a rope locking system. Check that the rope is properly engaged in the cleat to maintain tension on the rope (see point 3.5.1, fig.2b).

### 3.5.2.5 If your rope is too short

If your line is too short, connect two lines together:

1. Fig. 1-1: Use 2 bowline knots to link your two lines together.
2. Fig. 1-2: Allow approx. 1 m (3') of line to exceed the knot of the line pulling the load. This length of line will be used for pulling when the knot is undone.
3. Fig. 2: Stop the winch before the knots reach the winch; they will not be able to pass through and the line will become tangled.
4. Release the tension in the line. Attach the load to a fixed point if necessary.
5. Untie the line's knot and use the remaining length to wind it around the drum and restart the winch again.

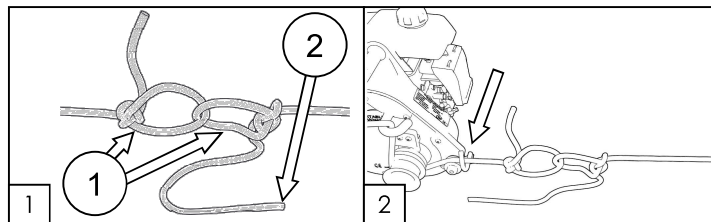

### 3.5.2.6 Stopping the winch

1. Gradually release the tension to gradually lower the winch towards the ground.
2. Lower the throttle lever to idle position (PCW3000).
3. Set the on/off switch to the OFF position.

**PRECAUTION** Do not touch the capstan drum after use. It may be hot and burn your skin.

## 4 Maintenance

### 4.1 Cleaning

When your work is complete, clean and dry the winch.

**PRECAUTION** DURING CLEANING, CHECK THE WINCH, THE HOOKS, THE LINE AND THE POLYESTER SLING FOR ANY DAMAGE OR SIGNS OF WEAR.

Regularly remove the capstan drum and clean around the shaft. Any accumulated debris may damage the seal. Brush the shaft with a little oil to avoid corrosion.

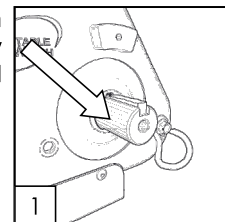

### 4.2 Lubrification

The gearbox is lubricated in the factory and thus should not require lubrication or maintenance. If oil losses become apparent, check the oil level by placing the winch on a level surface and unscrew the cap. Use an 8 mm hexagonal key.

When tipping the winch forwards, a little oil may escape through the hole. If required, you can add SAE80W90EP gear oil.

### 4.3 Honda engine

Maintain the engine according to the instructions provided in the Honda engine user manual.

### 4.4 Storage

Always store your Portable Capstan Winch™ on its base. Please consult the Honda engine user manual for storage instructions.

### 4.5 Spark arrestors

Since your winch is equipped with integrated spark arrestors, you must clean them after one hundred (100) hours of operation. Consult the Honda engine manual for the cleaning procedure.

## 5 Additional information

### 5.1 Accessories

A full range of accessories are available. Take a look at [www.portablewinch.com](http://www.portablewinch.com).

### 5.2 Warranty

The Portable Winch Co. winch and accessories are guaranteed against all manufacturing defects when owned by the "original owner" as defined here below.

The "original owner" is defined as the person or entity that purchased the winch or accessories from an authorized Portable Winch Co. dealer as shown by the original invoice. The warranty is transferable if the new buyer holds a copy of the original invoice. This warranty does not apply to items sold "as is". The warranty does not apply to the wear parts defined as those coming into contact with the line during pulling. Les treuils portables à cabestan sont ainsi couverts :

- PCW3000  
Commercial use: 1 year  
Private use: 5 years
- PCW4000  
Commercial use: 1 year  
Private use: 5 years

Serviced by Portable Winch Co. or its retailers.

Engine :

The Honda engine is guaranteed by Honda Motor Corporation, and the warranty period may vary from one country to another. All Honda service centres may make warranty repairs, if necessary. Please keep your proof of purchase (original invoice including the serial number of the winch). It will be used to establish the start date of the warranty period.

Portable Winch Co. will replace or repair, at its discretion, any faulty products. All other Portable Winch Co. accessories are covered by a one-year (1) warranty with the exception of the lines which are covered by a 3-month warranty. If you have any questions, please consult the warranty policy at [www.portablewinch.com](http://www.portablewinch.com).

#### **Extend your warranty for free**

We want to thank you for your purchase. To do this, we are offering you AN ADDITIONAL ONE-YEAR (1) WARRANTY FOR FREE! It's simple, just register your winch at [www.portablewinch.com](http://www.portablewinch.com) or over the phone on 1 888 388-7855 or + 1 819 563-2193.

### 5.3 Troubleshooting area

In case of problems, consult the Troubleshooting section at [www.portablewinch.com](http://www.portablewinch.com) in the Manuals and instructions section.

### 5.4 Exploded-views

To access the exploded view of your winch, consult Exploded views at [www.portablewinch.com](http://www.portablewinch.com) on the Manuals and instructions page or see the end of the manual.

## 5.5 Technical data

EN

SPÉCIFICATIONS	PCW3000
ENGINE	HONDA GX-35 4-STROKE ENGINE
FUEL TANK CAPACITY	0,63 L
DRUM DIMENSIONS	Ø 76 MM, UP TO 4 TURNS OF 10 MM ROPE
MAXIMUM PULLING FORCE (SINGLE LINE)	700 kg
SPEED	10 m/min
GEARBOX	HARDENED STEEL GEARS/OIL LUBRICATION
WEIGHT (DRY)	9,5 kg
DIMENSIONS (OVERALL)	35 cm x 28,9 cm x 26,1 cm
ROPE	DOUBLE BRAID POLYESTER WITH LOW ELASTICITY (NOT INCLUDED)
LENGTH	UNLIMITED
MINIMUM DIAMETER	10 mm
MAXIMUM DIAMETER	12-13 mm
RECOMMENDED DIAMETER	10 mm
Guaranteed sound power level LwA	108 dB(A)
Uncertainty factor included KwA	2.5 dB(A)

SPÉCIFICATIONS	PCW4000
ENGINE	HONDA GX-50 4-STROKE ENGINE
FUEL TANK CAPACITY	0,63 L
DRUM DIMENSIONS	Ø 76 MM, UP TO 4 TURNS OF 10 MM ROPE
MAXIMUM PULLING FORCE (SINGLE LINE)	1000 kg
SPEED	13,4 m/min
GEARBOX	HARDENED STEEL GEARS/OIL LUBRICATION
WEIGHT (DRY)	12 kg
DIMENSIONS (OVERALL)	42 cm x 30 cm x 28,5 cm
ROPE	DOUBLE BRAID POLYESTER WITH LOW ELASTICITY (NOT INCLUDED)
LENGTH	UNLIMITED
MINIMUM DIAMETER	10 mm
MAXIMUM DIAMETER	12-13 mm
RECOMMENDED DIAMETER	10 mm
Guaranteed sound power level LwA	112 dB(A)
Uncertainty factor included KwA	2.5 dB(A)

### 5.6 Manufacturer

The Portable Capstan Winches™ are manufactured by:

Portable Winch Co.  
1170, rue Thomas-Tremblay  
Sherbrooke, Québec, J1G 5G5  
CANADA  
Téléphone : +1 819 563-2193  
Freephone (CAN & É.-U.): 1-888-388-7855  
Fax : + 1 514 227-5196  
E-mail : [info@portablewinch.com](mailto:info@portablewinch.com)  
Website: [www.portablewinch.com](http://www.portablewinch.com)

**FRENCH IS THE ORIGINAL LANGUAGE OF THIS DOCUMENT**



**DECLARATION OF CONFORMITY**

We are located at:

**PORTABLE WINCH CO.**  
1170, rue Thomas-Tremblay  
Sherbrooke, QC J1G 5G5  
CANADA  
Tel: +1 819 563-2193  
[www.portablewinch.com](http://www.portablewinch.com)

Declare, under our sole responsibility, that the product :

Portable Capstan Winches  
Models PCW3000, PCW4000

Designed for this use:

Pulling objects at angles of +/- 45° on a horizontal surface.

In compliance with the "Machines" directive 2006/42/EC as well as the following directives:

- 2004/30/UE Electromagnetic Compatibility Directive.
- 2000/14/CE Directive on Environmental Noise Emissions.

M. Gerold Vonblon,  
Landstrasse 28, A-6714 Nuziders  
is authorized to compile the technical file.

Signed by:



Name: Pierre Roy  
Position: Managing Director

In Sherbrooke, QC, Canada  
July 31, 2020



# PCW3000

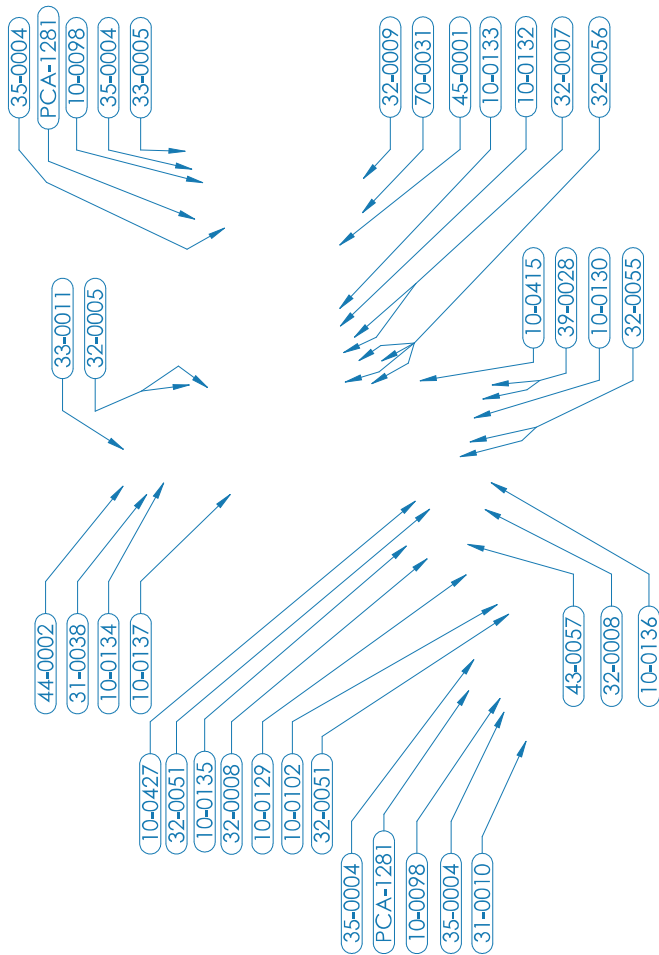

# PCW4000

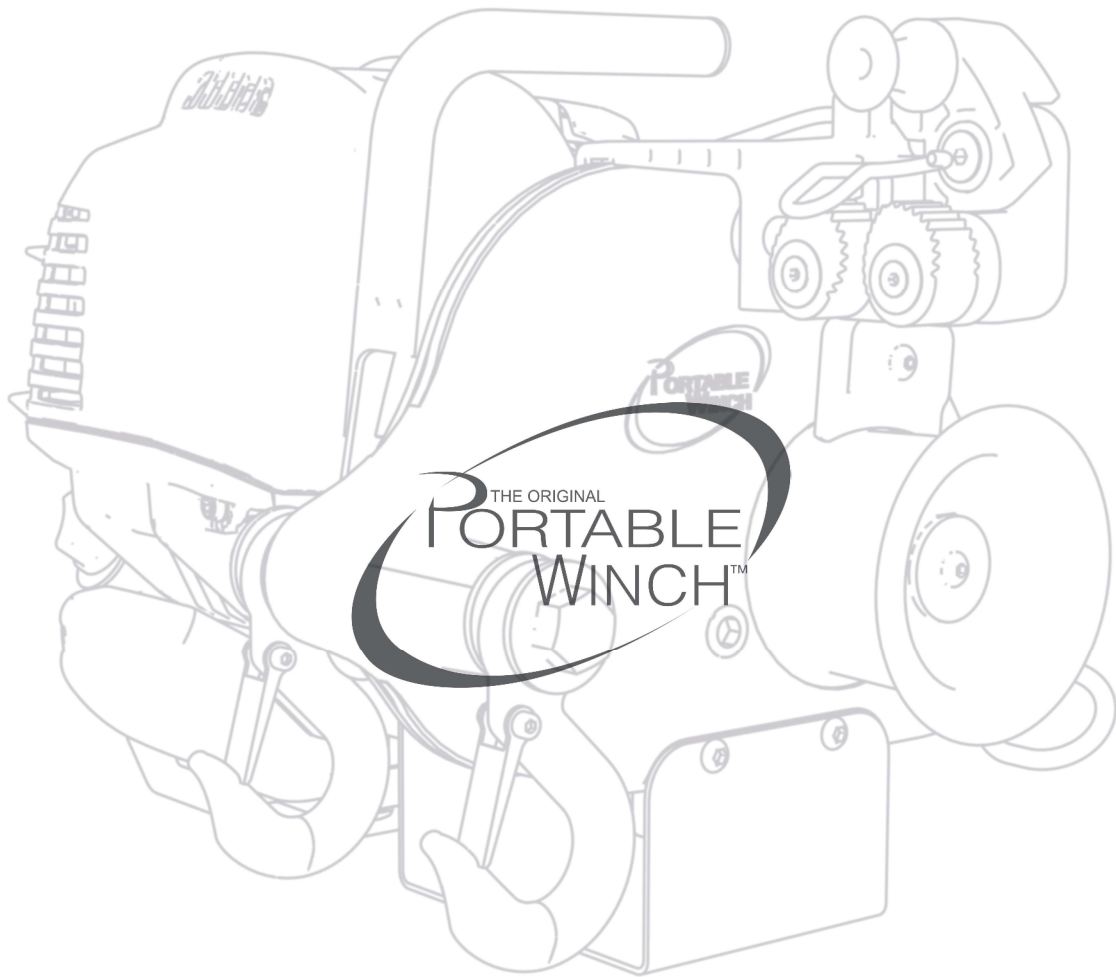

[www.portablewinch.com](http://www.portablewinch.com)

[info@portablewinch.com](mailto:info@portablewinch.com)

1 888 388-7855 / +1 819 563-2193