

XTIRPA™

**INSTRUCTION AND SAFETY MANUAL
XTIRPA DAVIT ARM, MAST AND ADJUSTABLE ADAPTOR
SYSTEM**

**UNIVERSAL RESCUE SYSTEM
IN-8010**

TO BE READ AND UNDERSTOOD BY USER PRIOR TO EACH USE



EC DECLARATION OF CONFORMITY (English)

Manufacturer established in the community:

*Produits de Services Publics INNOVA inc.,
1040, boul. Industriel, Granby, Québec, Canada J2J 1A4*

Declares that the following PPE product:

IN-8010 Davit arm, mast and adapter XTIRPA™ system for PPE.

is in conformity with the provisions of the regulation (EU) 2016/425 and complies to the standard:

Personal fall Protection Equipment type B EN 795: 2012

is identical to the PPE product which was submitted to the EC Certificate of Conformity no: 0082/1363/160/03/19/0307 delivered by:

APAVE SUDEUROPE SAS No 0082
8 rue Jean-Jacques Vernazza
Z.A.C. Saumaty-Séon - BP 193 -
13322 MARSEILLE CEDEX 16 - France

is submitted to the article 19c (module C2) of the regulation (EU) 2016/425, under the supervision of the notified body:

APAVE SUDEUROPE SAS No 0082
8 rue Jean-Jacques Vernazza
Z.A.C. Saumaty-Séon - BP 193 -
13322 MARSEILLE CEDEX 16 – France

Produced at: GRANBY, Québec Canada, July 2nd 2019



Michael Parker
Quality Manager

INTRODUCTION

WARNING

The XTIRPA system is part of a personal protection equipment system for fall protection, work positioning, or rescue, for use in confined spaces.

The user must read, understand and follow the manufacturer's instructions for each component or part of the complete XTIRPA system. These instructions must be provided to the user of the XTIRPA system. The user must read and understand these instructions before using the XTIRPA system. The manufacturer's instructions must be followed for proper use and maintenance of this product. Alterations or misuse of the XTIRPA system or of any component or part thereof or failure to follow instructions may result in serious injury or death, for which the manufacturer disclaims all warranties and liabilities whatsoever, user, owner and purchaser of the XTIRPA system waiving all claims, rights and recourses against the manufacturer and derived therefrom.

The XTIRPA system was designed for persons needing a personal protection equipment system for fall protection, work positioning, or rescue, for use in confined spaces. The XTIRPA system is intended to act as a support structure or anchor for these uses. Due to its design and the use of an advanced composite, the XTIRPA system is one of the lightest and most ergonomic systems of its kind on the market. Always keep this instruction and safety manual available to any worker needing to use the XTIRPA system. The XTIRPA system meets the standards EN 795: 2012 Type A and TS16415: 2013.

IMPORTANT: The buyer must complete and return the limited warranty registration form.

Always keep this instruction and safety manual available to any worker needing to use the XTIRPA system. Before each use, the user must read, understand and follow the manufacturer's instruction and safety manual.

Keep instructional and safety labels affixed to the XTIRPA system and its components and parts clean and legible at all times. Clean or replace if required. New labels can be obtained upon demand.

Establish a regular training program on the XTIRPA system for new & experienced workers, as further recommended in this instruction and safety manual. Establish a detailed inspection program for the XTIRPA system and document findings, as further recommended in this instruction and safety manual. Always inspect the XTIRPA system before each use and at least once a year by a competent person.

The XTIRPA system and its components and parts have labels indicating the maximum capacity of each. Exceeding said maximum capacity may result not only in damages to the XTIRPA system or its components or parts but also in serious injury or death, for which the manufacturer disclaims all warranties and liabilities whatsoever, user, owner and purchaser of the XTIRPA system waiving all claims, rights and recourses against the manufacturer derived therefrom.

The XTIRPA Universal Safety system, IN-8010 includes different options for the Manhole Collar for Fall Protection and Retrieval and different kinds of adjustable wall adapter, IN-2003 Mast for Fall Protection and Retrieval and IN-2210 Davit Arm for Fall Protection and Retrieval Including Secondary Block which conform to document number MU8010-012ENG rev04.

APAVE SUDEUROPE SAS (Headquarters: 8 rue Jean-Jacques Vernazza—Z.A.C. Saumaty-Séon - CS 60193 - 13322 MARSEILLE CEDEX 16) is the notified body involved in the initial production and certification control phase.

DESCRIPTION & INTERPRETATION OF MARKING SYMBOLS



This symbol is used to alert the user to a potential hazard. The safety of the worker is in jeopardy. It is imperative to follow the manufacturer's recommendations.



This symbol asks the user to read and understand the manual for this product before use.



This symbol specifies that the system can be used simultaneously by a maximum of 2 users.



Anchorage hardware must be qualified and experienced personnel. The installer must follow the anchorage hardware manufacturers recommendations at all times.



Periodic inspections of hardware must be done. In the occurrence of a fall or the safety of the equipment is in doubt, equipment must be immediately removed from service and inspected by qualified personnel before reuse.



Maximum permissible arresting force (MAF) .



The positioning pins must always be in place when manoeuvring personnel. Otherwise, serious injuries may occur.



Adaptors are designed to function only with the XTIRPA equipment or approved by the manufacturer.

-1- APPLICATION

The XTIRPA system, and its many components and parts (including davit arm, "H" base and mast), are intended to be used as part of a personal protection equipment system for fall protection, work positioning, personnel handling, materials handling, or rescue, for use in confined spaces. The XTIRPA system is intended to act as a support structure or anchor for these uses.

-2- RESTRICTIONS

- a) **CAPACITY:** The maximum working load (CMT) of this product is 360lbs (164kg). According to CE (EN 795: 2012 and TS16415: 2013), use an EN-360 and / or EN-363 fall protection system or EN-1496 recovery system.
- b) The manufacturer attests that anchoring devices have been tested accordingly to the current European standard (EN 795:2012 Type B and et TS16415 : 2013) and, except otherwise stipulated, they are to be used by a single person, by anchor point, using a shock absorber in accordance with regulation EN 355.
- c) **PRECAUTIONS:** Take the necessary precautions to limit injuries to the user and risks of damaging the XTIRPA system.
- d) Use of the XTIRPA system in areas where environmental hazards exist may require additional precautions to limit the possibility of injury to the user or damage to the XTIRPA system. Hazards may include, but are not limited to: high heat, fire, flame, smoke, fumes, caustic chemicals, corrosive environments, high voltage power lines, sudden changes of pressure, explosive or toxic gases or substances, water or risks of flooding, risks of wall, ceiling or floor collapsing, moving machinery and sharp edges.
- e) Install and secure all signaling and other precautionary and security measures, including but not limited to, notifying users, bystanders and vehicle operators circulating near the XTIRPA system of the presence of the XTIRPA system and its workers, before starting work.
- f) Wear all appropriate certified and recommended security equipment such as, but not limited to, hard hat, protective eyewear, leather gloves, protective clothing, work boots, harness in accordance with EN 361, flashlight and respiratory device if needed.

WARNING: Equipment shall not be used past its capacity, or in any other applications for which the equipment was not designed.

WARNING: The equipment should only be used by trained and competent persons in order for this product to be used safely.

- g) Always work in teams of at least two (2) people: 1 attendant and 1 confined space worker (the person attached to the lifeline cable or rope). These people must be qualified and trained on the XTIRPA system. They must have read and understood this instruction and safety manual before using the XTIRPA system. One person works in the confined space (the user attached to the lifeline cable or rope) and the other (attendant) pays out the line and reels it in, keeps in contact with the person inside and remains available in case of any emergency. The attendant makes sure, at all times, that the user who is tying his lifeline cable or rope to his harness is in the right position. The attendant also assures that the XTIRPA system is well in place and that no load imbalance is possible.

IMPORTANT: During installation of the system, it is important to ensure stability throughout.

- h) Use only a certified full body harness and lifeline cables and ropes for any user of the XTIRPA system, with appropriate specifications designed and recommended for use in specialized work conditions such as those for which the XTIRPA system is intended to be used as per this instruction and safety manual. For the installation of lifeline cables and ropes on the certified 13kN anchor points of the davit arm, see section 6 paragraphs 6 and 7.

IMPORTANT: When used as PPE, the system must be fitted with a device limiting the dynamic forces exerted on the user to a maximum of 6kN (1320 LbF).

- i) Plan your work program before starting. Have the required equipment, procedures and people, which must be qualified and trained on the XTIRPA system and who must have read and understood this instruction and safety manual before using the XTIRPA system, available to do the job.
- j) Keep all instructional and safety labels affixed on the XTIRPA system and its components and parts clean and legible at all times. Clean or replace if required. New labels can be obtained upon demand.

IMPORTANT: If the markings on the anchoring device are not legible after installation, it is recommended that supplementary markings next to the anchoring device be made.

WARNING: No modifications or additions to the equipment shall be performed without the authorization of the manufacturer, and all repairs shall be done as indicated by the operating procedure of the manufacturer.

WARNING: It is established and agreed that the equipment (system) is reserved for the use of a maximum of two people.

- k) Do not exceed 360lbs (164kg) per anchor, the maximum work load (CMT) of the system.
- l) Follow all applicable laws, regulations and standards for work, entry and exit in confined spaces.
- m) A person who has not read this instruction and safety manual, has not been trained in using the XTIRPA system and does not understand all operation, safety, maintenance, servicing and storage instructions contained in this instruction and safety manual and in any other recommendations provided by the manufacturer or its certified trainers is not qualified to operate the XTIRPA system and does it at their sole risk, therefore waiving any and all claims, rights and recourses against the manufacturer and derived therefrom.
- n) Make sure to conform to relative demands regarding anchoring devices (E.g.: floor adapter, wall adapter, etc.) or ensure that the chosen structure that will be used has an anchoring point, and keep in mind minimal required resistance, equivalency and position.

WARNING: Anchoring devices must be installed only by competent persons or organizations.

- o) The maximum force that can be applied by the system to the structure is a vertical force of 22kN (5000 lbf) according to CSA, ANSI, OSHA or 13kN according to EN362, EN795 : 2012 CE and TS16415 : 2013 from the anchor when the system is placed.

WARNING: The system must be appropriately checked, for example, by calculations or tests.

WARNING: The use of a base, structural anchor or fastener, if one exists, must be taken into account when calculating the amount of force supported by the anchor during strength and integrity testing.

- p) The maximum value of deflection, horizontal and vertical, on the highest point of the system, the top of the mast, is 152 mm (6 inches).
- q) A rescue plan shall be put in place in order to account for all likely emergencies that could occur while working.

WARNING: Any modification or addition to the equipment cannot be done without the prior written consent of the manufacturer, and any repairs must be undertaken in accordance with the manufacturer's procedures.

WARNING: It is established and agreed that the equipment (system) is reserved for the use of a maximum of two people.

WARNING: It is important to place the XTIRPA system on a hard and level surface. Do not use the XTIRPA system on a soft surface, including, but not limited to, sand, grass, gravel and rocks. If you have any questions about use or maintenance or whether the XTIRPA system is appropriate for your job, please contact the Manufacturer PSP INNOVA INC.

WARNING: For safety reasons, make sure when using the anti-drop system that you have enough space under the user, so as to avoid injury. If a fall occurs, there should be enough space to avoid a collision with the ground or any obstacle. See the diagram in Section 8 for calculating this distance.

XTIRPA SYSTEM REQUIREMENTS

IMPORTANT: If you have questions on the use, care or suitability of the XTIRPA system for your application, please contact the manufacturer INNOVA Public Utility Products Inc.

IMPORTANT: Record the product identification information from the ID label in the maintenance and inspection log of this instruction and safety manual.

IMPORTANT: Record purchasing date and also date of first use on the maintenance and inspection log sheet included in this safety instruction manual.

- a) The XTIRPA system is intended to be used as part of a personal protection equipment system for fall protection, work positioning, personnel handling, materials handling, or rescue, for use in confined spaces. The XTIRPA system is intended to act as a support structure or anchor for these uses. The XTIRPA system must be used only with adapters, anchors, connectors (EN 362), and other components, parts or subsystems that have been certified, approved and recommended by the Manufacturer.

WARNING: This system should never be used to transport personas and material at the same time.

- b) Substitutions or replacements made with non-approved adapters, anchors, connectors (EN 362), other components, parts or subsystems may be incompatible, may jeopardize the safety and reliability of the complete XTIRPA system and may result in serious injury or death, for which the Manufacturer disclaims all warranties and liabilities whatsoever, user, owner and purchaser of the XTIRPA system waiving all claims, rights and recourses against the Manufacturer derived therefrom.
- c) Connectors (EN 362) (hooks, carabiners, D-rings) must meet standard EN362.
- d) Make sure the lifeline cable or rope is positioned directly over the work area. Use only certified lifeline cable or rope, in perfect working condition, with appropriate specifications, including maximum leverage capabilities, for the intended use of the XTIRPA system.
- e) Owners must make sure that, before each use, all users of the XTIRPA system have read, understood and follow the manufacturer's Instructions and safety manual.
- f) Owners must also make sure that all users have successfully been trained in using the XTIRPA system, before allowing them to use the XTIRPA system, and at least annually thereafter.

IMPORTANT: During use, the manhole collar system must be appropriately sized and the adjustable wall adapter must be well-anchored in the wall.

- g) A person who has not read the Instruction and safety manual, has not been trained in using the XTIRPA system and does not understand all operation and safety instructions, is not qualified to operate the XTIRPA system. An untrained user exposes himself and others to

possible serious injury or death, for which the Manufacturer disclaims all warranties and liabilities whatsoever, user, owner and purchaser of the XTIRPA system waiving all claims, rights and recourses against the Manufacturer derived therefrom.

- h) Refer to and follow all EN standards or other local standards and regulations. Comply with all requirements of your local regulations for your applications.
- i) See other important operation instruction and safety information contained hereafter in this instruction and safety manual.
- j) It is imperative to supply all information in sufficient quantity to assure that different equipment articles are compatible when assembled as a system.

WARNING: It is possible that a hazard may occur while using multiple components, as one of them could affect the safety function of the system, if the safety function of one component can be affected by that of another component.

WARNING: It is essential for the safety of the user, if the product is resold to a destination outside the first country, that the reseller supplies the instruction manual, maintenance instruction log sheet for the periodic inspections and all associated repair instructions written in the native language of the country in which the product will be used. It is also required to supply all specific additional information for the equipment.

WARNING: Any persons with a medical condition which could cause a hazard to the user during normal operation and in emergency situations should avoid using the system.

- k) Life expectancy of the XTIRPA system and its components will be determined based on the conclusions of periodic and monthly inspections which will determine whether or not the product may remain in service.
- l) If possible, use a manhole guard to mark off and secure the work area.

WARNING: If the system has been used to stop a fall, it should not be used again until a competent person has, in writing, authorized its reuse.

WARNING: The safety of the user is in direct relation to the quality of maintenance and integrity of the equipment.

MAINTENANCE, SERVICING, STORAGE

- a) Before each use, the user must read and understand the manufacturer's Instruction and safety manual. Ensure that the markings are visible at all times.
- b) Before each use, carefully inspect the XTIRPA system and all components and parts thereof. Any defective parts or components could result in serious injury or death.
- c) The standards ANSI, OSHA, CSA and CE require a regular inspection program for all confined space entry/retrieval equipment and to maintain documented results of these inspections. Use the maintenance and inspection logs included in this instruction and safety manual to document the results.
- d) It is recommended that the anchoring device be marked with the most recent or next inspection date.
- e) Remove the XTIRPA system from service if a problem or an unsafe or defective condition is found during the inspection. Return to an authorized service center or the manufacturer for service.
- f) Replacement components and parts and additional maintenance and servicing procedures must be completed by an authorized service center which has been approved by the manufacturer, or by the manufacturer itself.
- g) If the crimping bolts of the adjustable wall adapter do not move freely, they must be lubricated with a light machine oil.
- h) Establish a monthly inspection which should be done by a competent person (person who is familiar, has been trained and has read and fully understands this instruction and safety manual), other than the user.

WARNING: A periodic inspection should be performed at least once every twelve months.

- i) Periodically clean the exterior of the davit arm and base, using water and mild detergent. Clean labels as required.
- j) When lowering the removable system, it is important to slowly place the system on the ground, to avoid damaging components.
- k) Store the XTIRPA system in a clean and dry environment, out of direct sunlight. Avoid areas with chemical or toxic vapors, substances or environments. Do not immerse or leave in direct contact with water, as corrosion and rust may occur. Inspect the XTIRPA system after any period of extended storage and at least once a month.
- l) The XTIRPA system and its components was designed for 10 years of continuous service. The life expectancy of the XTIRPA system and its components will be determined after periodic and monthly inspections that will determine whether or not the product may remain in service.
- m) All components and parts of the XTIRPA system should be stored in separate bags to facilitate transport and handling.

WARRANTY

The XTIRPA system offered by the Manufacturer, INNOVA Public Utility Products Inc., is warranted against manufacturing defects in workmanship and materials for a period of two (2) years from the date of shipment of the product, which warranty only covers the original purchaser of the XTIRPA system. The Manufacturer will promptly repair or replace all components or parts found to be defective, the Manufacturer reserving the right to elect to have any alleged defective part returned to its plant for inspection before making a repair or replacement.

Only components or parts found to be defective by the Manufacturer, at its sole discretion and upon any inspection requested and performed by the Manufacturer, will either be repaired or replaced by the Manufacturer, at its sole choice.

All claims must be forwarded in writing to the Manufacturer, immediately upon discovery by owner, and must be accompanied by a copy of the proof of purchase of the original purchaser. Manufacturer will issue a claim's number and give specific instructions to be followed as to claim's procedures and return of the defective part, if so requested by the Manufacturer. Owner will collaborate with Manufacturer and its representatives to allow inspection of any alleged defective part. All shipping costs to return defective components and parts to the manufacturer's plant are payable by owner, the cost of reshipping replacement components or parts being covered by the Manufacturer.

This warranty does not cover equipment damages resulting from any other cause than a manufacturing defect in workmanship or materials, including, without limitation, damages resulting from abuse, lack of maintenance, improper handling or storage, voluntary damages, vandalism, accidental damages or damages resulting from impact or collision, damage in transit, damages caused by fire, explosion, chemical, toxic or corrosive vapors, substances or environments, water, normal corrosion and rust, storms, hail, and other acts of God, war insurrection, acts of terrorism or other damage beyond the control of the Manufacturer. This warranty applies only to the original purchaser and is the only one applicable to the XTIRPA system, and is in lieu of all other warranties, expressed or implied. Without limiting the generality of the foregoing, the Manufacturer will not be liable nor responsible for any other cost, damages or claims whatsoever, including for any special, incidental, indirect, or consequential damages whatsoever such as, but not limited to, damages for loss of profits or expected revenues, for business interruption, for personal injury, for failure to meet any duty including of good faith or of reasonable care, for negligence, and for any other pecuniary or other loss whatsoever, arising out of or in any way related to the use of or inability to use the XTIRPA system, even in the event of the fault, tort (including negligence), strict liability, breach of contract or breach of warranty, even if the Manufacturer has been advised of the possibility of such damages. The Manufacturer hereby disclaims all other warranties and conditions, either express, implied or statutory, including, but not limited to, any implied warranties or conditions of merchantability, of fitness for a particular purpose or application, and of lack of negligence or lack of workmanlike effort.

IMPORTANT: The buyer must fill out and return the Limited Warranty registration form for each product.

XTIRPA SYSTEM DESCRIPTION

WARNING

The XTIRPA system is part of a personal fall arrest, work positioning, personnel handling, material handling or rescue system for use in confined spaces. The XTIRPA system is intended to act as a support structure or anchor for these uses. The user must read, understand and follow the manufacturer's instructions for each component or part of the complete XTIRPA system. These instructions must be provided to the user of the XTIRPA system. The user must read and understand these instructions before using the XTIRPA system. The manufacturer's instructions must be followed for proper use and maintenance of the XTIRPA system. Alterations or misuse of the XTIRPA system or failure to follow instructions may result in serious injury or death, for which the Manufacturer disclaims all warranties and liabilities whatsoever, user, owner and purchaser of the XTIRPA system waiving all claims, rights and recourses against the manufacturer and derived therefrom.

DESCRIPTIONS:

- MANHOLE COLLAR (MULTIPLE OPTIONS): (see illustration 1)
- ANGULAR MANHOLE COLLAR (MULTIPLE OPTIONS): (see illustration 2)
- ADJUSTABLE WALL ADAPTER (MULTIPLE OPTIONS): (see illustration 3)
- NON-ADJUSTABLE WALL ADAPTER (MULTIPLE OPTIONS): (see illustration 4)
- FALL PROTECTION, RETRIEVAL DAVIT ARM W/SECONDARY BLOCK: IN-2210 (see illustration 5)
- 76 MM (3 IN.) MAST FOR DAVIT ARM: IN-2003 (see illustration 6)
- 76MM (3 ") BARREL ADAPTER 51MM-267MM (2" -10 1/2 ") : IN-2482 (see illustration 7)
- XTIRPA DAVIT ARM, MAST AND ADJUSTABLE ADAPTOR SYSTEM FOR PPE: IN-8010 (see illustration 8)

Illustration 1:
MANHOLE COLLAR (MULTIPLE OP-
TIONS) (IN-2287) (IN-2180)

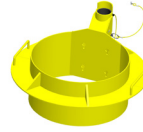

Diamètre / Diameter

16"-18" (406mm- 457mm)	18"-20" (457mm- 508mm)	20"-22" (508mm- 559mm)	22"-24" (559mm- 610mm)	24"-26" (610mm- 660mm)	26"-28" (660mm- 711mm)	28"-30" (711mm- 762mm)	30"-32" (762mm- 813mm)	32"-34" (813mm- 864mm)	34"-36" (864mm- 915mm)	36"-38" (915mm- 965mm)	38"-40" (965mm- 1016mm)	40"-42" (1016mm- 1067mm)	42 1/2"-44" (1080mm- 1118mm)
IN-2287 (Spécimen/ Test Sample)												IN-2180 (Spécimen/ Test Sample)	

Illustration 2:
ANGULAR MANHOLE COLLAR (MULTI-
PLE OPTIONS) (IN-2437) (IN-2440)



Diamètre / Diameter

Angle	16"-18" (406mm-457mm)	18"-20" (457mm-508mm)	20"-22" (508mm-559mm)	22"-24" (559mm-610mm)	24"-26" (610mm-660mm)	26"-28" (660mm-711mm)	28"-30" (711mm-762mm)	30"-32" (762mm-813mm)
5°	IN-2437 (Spécimen/ Test Sample)							IN-2438 (Spécimen/ Test Sample)
10°								
15°								
20°								
25°								
30°	IN-2439 (Spécimen/ Test Sample)							IN-2440 (Spécimen/ Test Sample)

Illustration 3:
ADJUSTABLE WALL ADAPTER (MULTIPLE OPTIONS)
IN-2008 ; IN-2075 ; IN-2125 ; IN-2168 ; IN-2251

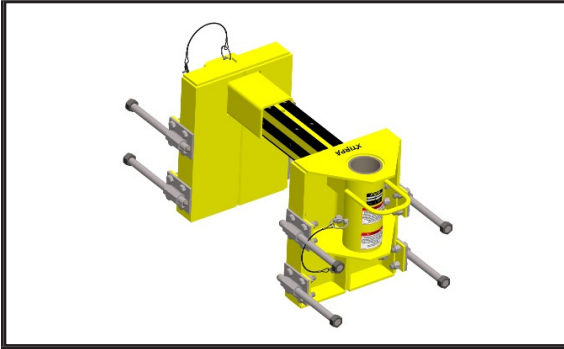

Illustration 6: IN-2003



Illustration 4:
NON-ADJUSTABLE WALL ADAPTER (MULTIPLE OPTIONS):
IN-2021 ; IN-2129 ; IN-2315

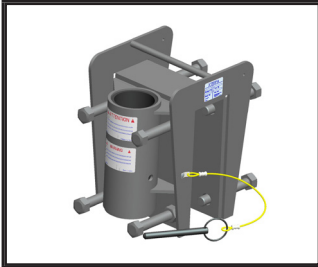

Illustration 7 - IN-2482

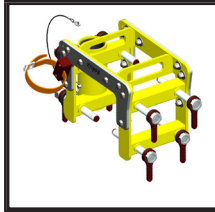
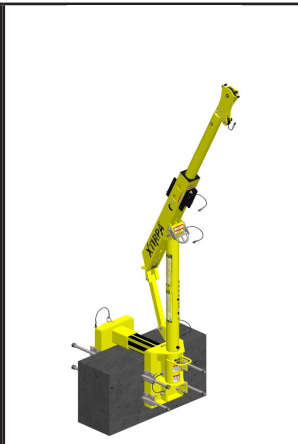
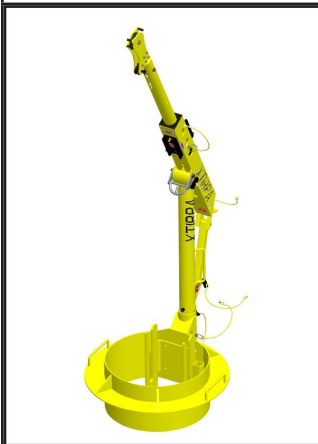

Illustration 5: IN-2210



Illustration 8: IN-8010



OPERATION, ASSEMBLY AND USE XTIR-PA SYSTEM

WARNING: The XTIRPA system is part of a personal fall arrest, work positioning, personnel handling, material handling or rescue system for use in confined spaces. The XTIRPA system is intended to act as a support structure or anchor for these uses. The user must read, understand and follow the manufacturer's instructions for each component or part of the complete XTIRPA system.

WARNING: These instructions must be provided to the user of the XTIRPA system. The user must read and understand these instructions before using the XTIRPA system. The manufacturer's instructions must be followed for proper use and maintenance of the XTIRPA system. Alterations or misuse of the XTIRPA system or failure to follow instructions may result in serious injury or death, for which the Manufacturer disclaims all warranties and liabilities whatsoever, user, owner and purchaser of the XTIRPA system waiving all claims, rights and recourses against the manufacturer and derived therefrom.

IMPORTANT: If you have questions on the use, care or suitability of the XTIRPA system for your application, please contact the Manufacturer INNOVA Public Utility Products Inc.

IMPORTANT: Record the product identification information from the ID label in the maintenance and inspection log of this instruction and safety manual.

OPERATION AND INSTALLATION OF PPE SYSTEMS WITH STRAIGHT INPUT RINGS - 16" (IN-2287) TO 44" (ANGULAR INPUTS) - 5 ° X 16" (IN-2437) AT 30 ° X 32" (IN-2440)

1. Make sure that all components and parts are in perfect working order and that everything is functioning correctly.

2. Secure the work area and remove the manhole cover.



- 3.** Insert the collar into the manhole, making sure that it is ledged firmly around the manhole's circumference.



- 4.** If possible, tighten the holding clamps to prevent the collar from toppling backwards. #1: Pull the handle for a quick adjustment, then #2 tighten the bolt for optimum fit.

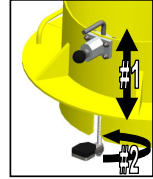

- 5.** Insert the mast into the designed spot.



- 6.** Lock the mast with a locking pin.



- 7.** Use the crimping handle behind the base to stabilize the mast.



- 8.** Remove both pins from their locations.



9. Install the receptacle of the davit arm on the mast.

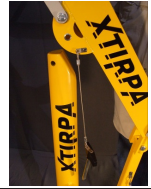

10. Lock everything with the first pin.



11. Install the lower leg of the davit arm between the eyelets of the mast and lock it with the second pin.



WARNING: Make sure that the system is in the right position and that all components are locked with the provided pin.

WARNING: It is important to place the XTIRPA system on a hard and level surface. Do not use the XTIRPA system on a soft surface, including, but not limited to, sand, grass, gravel and rocks. If you have any questions about the use or maintenance or whether the XTIRPA system is appropriate for your job, please contact the manufacturer PSP INNOVA INC.

OPERATION AND INSTALLATION OF THE ADJUSTABLE WALL ADAPTER SYSTEM

1. Make sure that all components and parts are in perfect working order and that everything functions correctly.

2. Install the adaptor on the low concrete wall.



3. Adjust the removable part so that there is the smallest possible gap (less than 50 mm) for the bolts and lock with the pin.



4. With the torque wrench, apply specific torque to each of the eight bolts.



5. Insert the mast into the provided wing.



6. Lock the mast with the locking pin.



7. Remove both pins from their locations.



8. Install the receptacle of the davit arm on the mast.

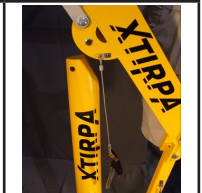

9. Lock everything with the first pin.



- 10.** Install the lower leg of the davit arm between the eyelets of the mast and lock it with the second pin.



WARNING: Make sure that the system is in the right position and that all components are locked with the provided pin.

WARNING: It is important to place the XTIRPA system on a hard and level surface. Do not use the XTIRPA system on a soft surface, including, but not limited to, sand, grass, gravel and rocks. If you have any questions about the use or maintenance or whether the XTIRPA system is appropriate for your job, please contact the manufacturer PSP INNOVA INC.

OPERATION AND INSTALLATION OF THE ADJUSTABLE WALL ADAPTER SYSTEM

1. Make sure that all components and parts are in perfect working order and that everything is working properly.

2. Install the adapter on the wall.

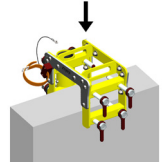

3. Using a torque wrench, apply 25 to 30 foot-pounds of torque to the eight (8) nuts.

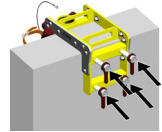

4. Insert the mast into the adapter.

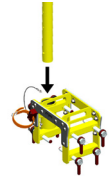

5. Lock the mast using the locking pin.

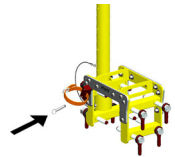

WARNING: Make sure that the system is correctly positioned and that all components are locked using the pin provided for this purpose.

WARNING: It is important to position the XTIRPA system on a hard, level surface. Do not use the XTIRPA system on soft ground, such as, but not limited to, sand, lawn, gravel and rocks. If you have any questions regarding the use, maintenance or suitability of the XTIRPA system for your application, please contact the Manufacturer PSP INNOVA INC.

OPERATION AND INSTALLATION OF THE WINCH ON BASE OF DAVIT ARM

1. Install the winch on the base of the davit arm. Use a locking pin which was provided with the winch adaptor and lock it.



2. A second lifeline can be installed on the gray "D" anchor point.

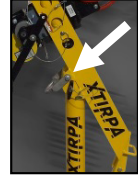

3. Install the lifeline cable or rope or winch on mounting bracket made to accept the hoisting device. Pass the lifeline cable or rope into the pulley located at the top end of the davit arm. Make sure that the cable or rope is securely in place.



4. If a material / positioning winch is required, use the bottom mounting bracket located under the davit arm. Install winch to mounting bracket and lock with pin attached to winch.



5. Remove the small pulley locking pin. Position cable over pulley and re-install pulley using locking pin.



WARNING: It is strictly forbidden to use the winch when it is located underneath the davit arm.

WARNING: It should be noted that only plates, support and adaptors that have been certified, approved and recommended by the manufacturer can be used.

6. Remove locking pin located in the mid section of the davit arm.



7. Extend the inner mast to full extension. Replace locking pin to secure the davit arm.

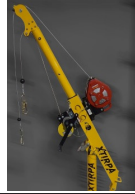

IMPORTANT: Make sure that the lifeline cable or rope is directly positioned above the working area. Only use certified lifeline cables or ropes in perfect condition, that have the appropriate specifications, including maximum lifting capacity, for the intended use of the XTIRPA system.

WARNING: Always use a manhole guard to secure your working area and to prevent falls.

WARNING: A fall protection harness is the only body support device allowed to be used for fall protection.

IMPORTANT: The fall protection harness must be attached to the winch's cable or rope by the anchoring point of the harness.

WARNING: The manufacturer's Instruction and safety manual must be followed for proper use and maintenance of this product. Alterations or misuse of this product or failure to follow instructions may result in serious injury or death for which the manufacturer disclaims all warranties and liabilities whatsoever, user, owner and purchaser of the XTIRPA system waiving all claims, rights and recourses against the manufacturer derived therefrom.

WARNING: Any system must be immediately removed from circulation if its safety is questioned, or if it was used to stop a fall. It is imperative not to use the system before a competent person authorizes in writing the integrity of the product before its reuse.

WARNING: For the fall arrest systems, it is essential for safety that the anchoring device or the anchor point is always correctly positioned and that effort is made so as to reduce the risk of falls and the height of fall. It is essential that the device or the anchor point is placed above the position of the user.

WARNING: When using a fall arrest system, it is essential, for security measures, to verify the required open space underneath the user on the workplace before each use, if possible, so that in case of a fall that there is no collision with the ground or any object in the area.

WARNING: The XTIRPA system must be used only with adapters, anchors, connectors, pulleys, other components, parts and subsystems certified, approved and recommended by the manufacturer. Substitutions or replacements made with non-approved adapters, anchors, connectors, other components, parts or subsystems may be incompatible, and may jeopardize the safety and reliability of the complete XTIRPA system and may result in serious injury or death, for which manufacturer disclaims all warranties and liabilities whatsoever, user, owner and purchaser of the XTIRPA system waiving all claims, rights and recourses against the manufacturer derived therefrom. Connectors (hooks, carabiners, D-rings) must meet the EN362 standards.

KEEP THE FOLLOWING INSTRUCTIONAL AND SAFETY SIGNS CLEAN AND LEGIBLE AT ALL TIMES



XTIRPA
IN-2210
Devil Arm

Standards:
EN 795:2012 and TS 16415:2013

Maximum Working Load:
320 lb (150 kg) or
352 lb (154 kg) when used with rated S2205.

Materials:
Aluminum, Stainless Steel, Dacron™

Inspection:
Before each use, inspect the XTIRPA system to determine if it is in perfect working condition.

At least once a month, the XTIRPA system components should be inspected and documented by a competent person in accordance with the user's instruction and safety manual.

Do not use if inspection reveals a problem, or unsafe condition or defect. Must not be repaired by anyone other than the manufacturer or an authorized service center. Cannot be repaired by the user.

Installation and use:
Ensure that all components and parts are correctly used in accordance with the user's instruction. Make sure that your anchoring points are in perfect working condition. Remove both handle pins from this location. Place each arm down onto the integrated mast of the manhole cover and/or onto the mast.

Place the lower leg of the davit arm between the lower eyelids of the manhole guard and/or the mast and lock with the handle pin. Lock the davit arm above onto the manhole guard or mast with the second handle pin. Insert the handle pin into the mounting bracket or adaptor on top of the davit arm and give counterweight one full turn. Release the handle pin. Insert the handle pin located in the middle of the davit arm into the mounting bracket and from release the pin to lock everything in place.

A manhole inspection which is designed to use the mounting bracket or adaptor located below the davit arm. It is strictly prohibited to use the bracket below the mast with a fall arrest anchor or device.

Remove the small pulley locking pin. Place the work cable through the opening between the pulley under the cable and lock back in place using locking pin.

Only qualified and trained personnel, certified and recommended by the manufacturer, are to be used with the XTIRPA system.

Warning:
For all other davit arm applications, consult manufacturer or distributor.

Manufacturer's instructions must be followed for proper use and maintenance of the product. Alterations or misuse of the product or failure to follow instructions may result in serious injury or death. The user, owner and purchaser of the XTIRPA system shall be held responsible for any injury or death, for which the manufacturer and distributor shall not be held responsible.

Notes:
US 2 243 710 B2
US 2 243 711
EP 03 764 266 B

Product manufactured by:
Innova Public Utility Products Inc.
14000 146th Ave. S.
Burien, WA 98148
Canada
S2205-005 rev 2

Made in Canada



XTIRPA
IN-2203
Mast

Standards:
EN 795:2012 and TS 16415:2013

Maximum Working Load:
320 lb (150 kg)

Materials:
Aluminum, Stainless steel

Inspection:
Before each use, inspect the XTIRPA system to determine if it is in perfect working condition. At least once a month, all components of the XTIRPA system should be inspected in accordance with the user's instruction and safety manual.

Do not use if inspection reveals a problem, or unsafe condition or defect. Must not be repaired by anyone other than the manufacturer or an authorized service center. Must not be repaired by the user.

Installation and use:
Ensure that all components and parts are in perfect working condition and working properly. Make sure that the anchoring points are in perfect working condition. Remove interlocking of the pulley adaptor. Insure that you wear your seat approved and certified feed or mobile safety harness and attach into the anchor point and ensure that you are not swinging.

Warning:
For all other mast applications, consult manufacturer or distributor.

Manufacturer's instructions must be followed for proper use and maintenance of the product. Alterations or misuse of the product or failure to follow instructions may result in serious injury or death. The user, owner and purchaser of the XTIRPA system shall be held responsible for any injury or death, for which the manufacturer and distributor shall not be held responsible.

Notes:
US 2 243 710 B2
US 2 243 711
EP 03 764 266 B

Product manufactured by:
Innova Public Utility Products Inc.
14000 146th Ave. S.
Burien, WA 98148
Canada
S2203-004 rev 2

Made in Canada

SERIAL NUMBER LABEL

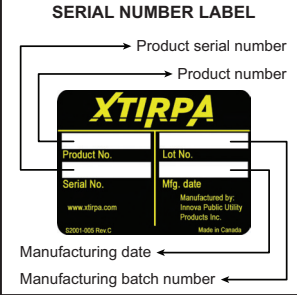

Product serial number
Product number
Product No.
Lot No.
Serial No.
Mfg. date
52201-005 Rev C
Manufacturing date
Manufacturing batch number

CE ACCREDITATION LABEL

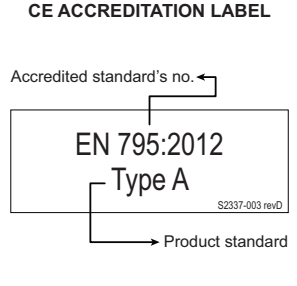

Accredited standard's no.
EN 795:2012
Type A
S2337-003 rev D
Product standard

CE ACCREDITATION LABEL

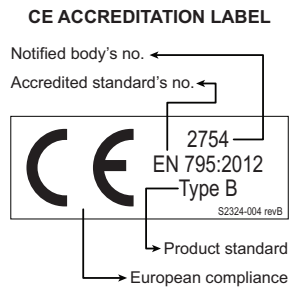

Notified body's no.
Accredited standard's no.
2754
EN 795:2012
Type B
S2324-004 rev B
Product standard
European compliance

CE ACCREDITATION LABEL

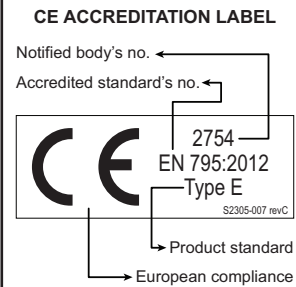

Notified body's no.
Accredited standard's no.
2754
EN 795:2012
Type E
S2305-007 rev C
Product standard
European compliance

WARNING

DO NOT USE FALL ARREST DEVICE
IN THIS POSITION

S2302-007 Rev B

WARNING

RESCUE ANCHOR POINT
RATED: 5000lbf (22kN)

S2219-012 Rev B

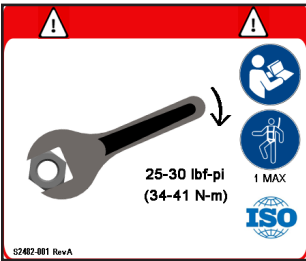
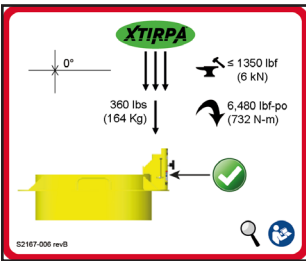
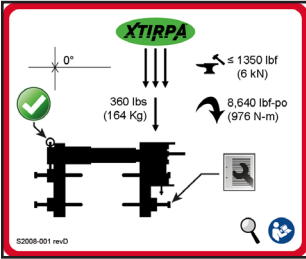

-8-
CALCULATION DIAGRAM

Ground Clearance:

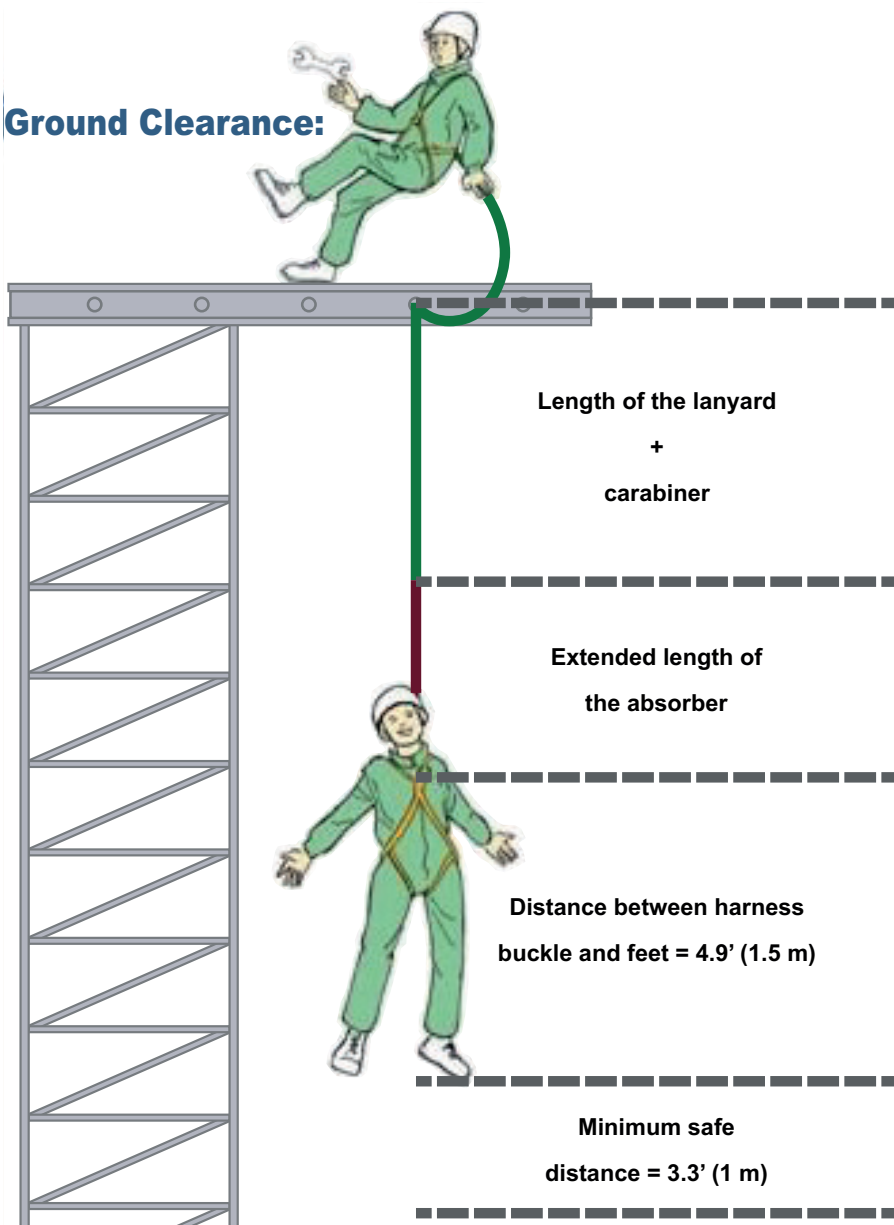

Pay attention to the distance to the ground!



MAINTENANCE AND INSPECTION LOG



Produits de Services Publics - Public Utility Products Inc.

Product: _____

Purchasing date: _____

Model number: _____

Manufacturing date: _____

Date of next inspection: _____

Date of 1st use: _____

INSPECTION DATE	LABELS	CORROSION	STRUCTURAL DAMAGE	WELDING	PINS & HARDWARE	OTHER (SPECIFY)	CORRECTIVE ACTION TAKEN (if required)	INSPECTED BY:
	<input type="checkbox"/>	<input type="checkbox"/>	<input type="checkbox"/>	<input type="checkbox"/>	<input type="checkbox"/>			
	<input type="checkbox"/>	<input type="checkbox"/>	<input type="checkbox"/>	<input type="checkbox"/>	<input type="checkbox"/>			
	<input type="checkbox"/>	<input type="checkbox"/>	<input type="checkbox"/>	<input type="checkbox"/>	<input type="checkbox"/>			
	<input type="checkbox"/>	<input type="checkbox"/>	<input type="checkbox"/>	<input type="checkbox"/>	<input type="checkbox"/>			
	<input type="checkbox"/>	<input type="checkbox"/>	<input type="checkbox"/>	<input type="checkbox"/>	<input type="checkbox"/>			
	<input type="checkbox"/>	<input type="checkbox"/>	<input type="checkbox"/>	<input type="checkbox"/>	<input type="checkbox"/>			
	<input type="checkbox"/>	<input type="checkbox"/>	<input type="checkbox"/>	<input type="checkbox"/>	<input type="checkbox"/>			
	<input type="checkbox"/>	<input type="checkbox"/>	<input type="checkbox"/>	<input type="checkbox"/>	<input type="checkbox"/>			
	<input type="checkbox"/>	<input type="checkbox"/>	<input type="checkbox"/>	<input type="checkbox"/>	<input type="checkbox"/>			
	<input type="checkbox"/>	<input type="checkbox"/>	<input type="checkbox"/>	<input type="checkbox"/>	<input type="checkbox"/>			
	<input type="checkbox"/>	<input type="checkbox"/>	<input type="checkbox"/>	<input type="checkbox"/>	<input type="checkbox"/>			
	<input type="checkbox"/>	<input type="checkbox"/>	<input type="checkbox"/>	<input type="checkbox"/>	<input type="checkbox"/>			

COMMENTS: _____

*Any failure to follow the Manufacturer's instructions contained in the instruction and safety manual, including with regard to the inspection and maintenance of the XTIRPA system and of components and parts there of, will cause warranty to become null and void and may result in serious injury or death of the user, for which the Manufacturer disclaims all warranties and liabilities whatsoever, user, owner and purchaser of the XTIRPA system waiving all claims, rights and recourses against Manufacturer and derived there from.

Manufactured by: INNOVA Public Utility Products Inc. 1040 boul. Industriel, Granby, Quebec, Canada J2J 1A4 Tel: (450) 777-1240 Fax: (450) 372-9936

This warranty applies only to the original purchaser and is the only one applicable to the Xtirpa System, and is in lieu of all other warranties, expressed or implied. The purchaser has to complete and return to INNOVA Public Utility Products Inc., all information within thirty days of purchase. Otherwise limited warranty will be void, if the product is not registered.

Register now: Mail or fax this registration form or visit our web site and register online.
 Mail: INNOVA Public Utility Products Inc., 1040, boul. Industriel, Granby J2J 1A4
 Fax: (450) 372-9936
 Web site: www.xtirpa.com

XTRIPA PRODUCT

Model number: _____

Purchasing date: _____

Serial number: _____

Manufacturing date: _____

CUSTOMER / USER INFORMATION

Company: _____

Phone: _____

Street address: _____

Fax: _____

City: _____

E-Mail: _____

Zip: _____

State: _____

Name: _____

Do you wish to be on Innova's mailing list

Position: _____

for new product literature: YES NO

*Any failure to follow the Manufacturer's instructions contained in the instruction and safety manual, including with regard to the inspection and maintenance of the XTRIPA system and of components and parts thereof, will cause warranty to become null and void and may result in serious injury or death of the user, for which the Manufacturer disclaims all warranties and liabilities whatsoever, user, owner and purchaser of the XTRIPA system waiving all claims, rights and recourses against Manufacturer and derived there from.

Manufactured by: INNOVA Public Utility Products Inc. 1040 boul. Industriel, Granby, Quebec, Canada J2J 1A4

Tel: (450) 777-1240 Fax: (450) 372-9936

XTIRPA™

CONFINED SPACE SAFETY SOLUTIONS

Head Office and Manufacturing Plant

Innova Public Utility Productions Inc.
1040, Boulevard Industriel
Canada, Qc, Canada
J2J 1A4

Phone: 450.777.1240
Toll free: 1.800.461.1937

www.xtirpa.com



Xtirpa is a registered trademark of Innova
Public Utility Productions Inc. used under
license in Canada

MU8010-012ENG rev04