

XTIRPA™

INSTRUCTION AND SAFETY MANUAL
XTIRPA™ Extendable Vehicle Hitch System for PPE

UNIVERSAL RESCUE SYSTEM
IN-8007

TO BE READ AND UNDERSTOOD BY USER PRIOR TO EACH USE



Innova
Produits de Services Publics - Public Utility Products Inc.

INNOVA Public Utility Products Inc.
1040 Boulevard Industriel, Granby, Québec, Canada
Tel (450) 777-1240 Fax (450) 372-9936 www.xtirpa.com

MU8007-EN-(en-us)

EC DECLARATION OF CONFORMITY (English)



Manufacturer established in the community:

Produits de Services Publics INNOVA Inc.,
1040, boul. Industriel, Granby,
Québec, Canada, J2J 1A4

Declares that the following PPE product:

IN-8007: XTIRPA™ EXTENDABLE VEHICLE HITCH SYSTEM FOR PPE

is in conformity with the provisions of the regulation (EU) 2016/425 and complies to the standard:

• **EN 795.2012 Type B, Type E**

is identical to the PPE product which was submitted to the EC Certificate of Conformity no:
2927/1363/160/11/22/0014, 2927/1363/160/11/22/0015 delivered by:

QC QUINTIN CERTIFICATIONS (2729)
825 route de Romans
38160 Saint-Antoine-l'Abbaye
France

is submitted to the article 19c (module C2) of the regulation (EU) 2016/425, under the supervision of the notified body:

QC QUINTIN CERTIFICATIONS (2729)
825 route de Romans
38160 Saint-Antoine-l'Abbaye
France



2023-01-10

MICHAEL PARKER ing./PE
Dir. R&D | R&D Manager

INTRODUCTION

WARNING

The XTIRPA system is part of a personal protection equipment system for fall protection, work positioning, or rescue, for use in confined spaces.

The user must read, understand and follow the Manufacturer's instructions for each component or part of the complete XTIRPA system. These instructions must be provided to the user of the XTIRPA system. The user must read and understand these instructions before using the XTIRPA system. The manufacturer's instructions must be followed for proper use and maintenance of this product. Alterations or misuse of the XTIRPA system or of any component or part thereof or failure to follow instructions may result in serious injury or death, for which the manufacturer disclaims all warranties and liabilities whatsoever, user, owner and purchaser of the XTIRPA system waiving all claims, rights and recourses against the manufacturer and

The XTIRPA system was engineered for those needing a personal protection equipment system, fall protection, and offers a solution for the entry, rescue and positioning of personnel and goods in isolation. The XTIRPA system was engineered to act as a supporting or anchoring structure for these uses. The XTIRPA system is one of the lightest and most ergonomic systems in its category on the market, thanks to its design and use of a technologically-advanced composite. The XTIRPA System meets the EN 795 standards: 2012 Type A, Type B, Type E and TS 16415:2013.

IMPORTANT: The buyer must complete and return the limited warranty registration form.

Always keep this instruction and safety manual available to any worker needing to use the XTIRPA system. Before each use, the user must read, understand and follow the manufacturer's instruction and safety manual.

Keep instructional and safety labels affixed to the XTIRPA system and its components and parts clean and legible at all times. Clean or replace if required. New labels can be obtained upon demand.

Establish a regular training program on the XTIRPA system for new & experienced workers, as further recommended in this instruction and safety manual. Establish a detailed inspection program for the XTIRPA system and document findings, as further recommended in this instruction and safety manual. Always inspect the XTIRPA system before each use and at least once a year.

The XTIRPA system and its components and parts have labels indicating the maximum capacity of each. Exceeding said maximum capacity may result not only in damages to the XTIRPA system or its components or parts but also in serious injury or death, for which the manufacturer disclaims all warranties and liabilities whatsoever, user, owner and purchaser of the XTIRPA system waiving all claims, rights and recourses against the manufacturer derived therefrom.

The XTIRPA Universal Safety system, IN-8007, including components: Mast, Davit Arm, Coupling system, counterweight, adapter and optional accessories, conforms to document number *MU8007-EN-(en-us)*.

APAVE SUDEUROPE SAS (Headquarters: 8 rue Jean-Jacques Vernazza—Z.A.C. Saumaty-Séon - CS 60193 - 13322 MARSEILLE CEDEX 16) is the notified body involved in the initial production and certification control phase.

SYMBOLS

WARNING

Indicates a dangerous situation which, if it not avoided, could lead to death or a dangerous injury.

CAUTION

Indicates a dangerous situation which, if it not avoided, could lead to a minor or moderate injury.

Indicated the safe working condition.



Please read and understand this system's operating manual before using it.



An anchor point authorized on the system indicating the maximum number of simultaneous users, wearing their harness. The system can also be used to lift and lower users.



The system can be used to lift and lower users.



The system cannot be used to lift and lower users.



The system's equipment must be installed by a qualified person in accordance with the manufacturer's instructions.



Please perform a visual inspection before any use, in accordance with the manual's instructions. Please do not use the system in case of doubt regarding its safe use.



Maximum working moment (MWM).



Minimum and maximum service temperature.



Maximum working load.

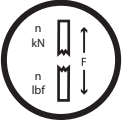

Minimum breaking strength (MBS).



Required tightening for bolt.



Equipment maximum arrest force (MAF).



The positioning pins must be installed before use.



Minimum breaking strength (MBS) of 22.2 kN (5000 lbf).

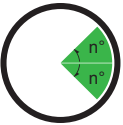

Permissible working angle.



It is forbidden to install more than (1) user on the same anchor point.

-1-

APPLICATION

The XTIRPA system, and its many components and parts (including davit arm, manhole guard, movable adapter, permanent adapter, integrated mast and side entry cart), are intended to be used as part of a personal protection equipment system for fall protection, work positioning, personnel handling, materials handling, or rescue, for use in confined spaces. The XTIRPA system is intended to act as a support structure or anchor for these uses.

-2- RESTRICTIONS

- a) **CAPACITY:** This product's maximum workload is 360 lbs (164 kg). Per CE (EN 795:2012 and TS 16415:2013), use a fall arrest system EN 360 and/or EN 363 or collection system EN 1496
- b) The manufacturer confirms that the anchors have been subjected to tests in accordance with the current European standard (EN 795:2012 Type A, Type B, and Type E and TS 16415:2013) and that, unless otherwise indicated, they are suitable for use by one person only, per anchor point, with a shock absorber compliant with EN 355.
- c) **PRECAUTIONS:** Take the necessary precautions to limit injuries to the user and risks of damaging the XTIRPA system.
- d) Use of the XTIRPA system in areas where environmental hazards exist may require additional precautions to limit the possibility of injury to the user or damage to the XTIRPA system. Hazards may include, but are not limited to: high heat, fire, flame, smoke, fumes, caustic chemicals, corrosive environments, high voltage power lines, sudden changes of pressure, explosive or toxic gases or substances, water or risks of flooding, risks of wall, ceiling or floor collapsing, moving machinery and sharp edges.
- e) Install and secure all signaling and other precautionary and security measures, including but not limited to, notifying users, bystanders and vehicle operators circulating near the XTIRPA system of the presence of the XTIRPA system and its workers, before starting work.
- f) Wear all appropriate certified and recommended security equipment such as, but not limited to, hard hat, protective eyewear, leather gloves, protective clothing, work boots, harness in accordance with EN 361, flashlight and respiratory device if needed.

WARNING: Equipment shall not be used past its capacity, or in any other applications for which the equipment was not designed.

WARNING: The equipment must only be used by trained and competent people in order for this product to be used safely.

- g) Always work in teams of at least two (2) people: 1 attendant and 1 confined space worker (the person attached to the lifeline cable or rope). These people must be qualified and trained on the XTIRPA system. They must have read and understood this instruction and safety manual before using the XTIRPA system. One person works in the confined space (the user attached to the lifeline cable or rope) and the other (attendant) pays out the line and reels it in, keeps in contact with the person inside and remains available in case of any emergency. The attendant makes sure, at all times, that the user who is tying his lifeline cable or rope to his EN 361-compliant harness is in the right position. The attendant also assures that the XTIRPA system is well in place and that no load imbalance is possible.

IMPORTANT: During installation of the system it is important to ensure stability throughout.

- h) Use only a certified EN 361 compliant full body harness and lifeline cables and ropes for any user of the XTIRPA system, with appropriate specifications designed and recommended for use in specialized work conditions such as those for which the XTIRPA system is intended

to be used as per this instruction and safety manual. For the installation of lifeline cables and ropes on the certified 12kn anchor points of the davit arm, see section 6 paragraphs 3 through 5.

IMPORTANT: When used as PPE, the system must be fitted with a device limiting the dynamic forces exerted on the user to a maximum of 6kN (1320 LbF).

- i) Plan your work program before starting. Have the required equipment, procedures and people, which must be qualified and trained on the XTIRPA system and who must have read and understood this Instruction and safety manual before using the XTIRPA system, available to do the job.
- j) Keep all instructional and safety labels affixed on the XTIRPA system and its components and parts clean and legible at all times. Clean or replace if required. New labels can be obtained upon demand.

IMPORTANT: If the markings on the anchoring device are not legible after installation, it is recommended that supplementary markings next to the anchoring device be made.

WARNING: No modifications or additions to the equipment shall be performed without the authorization of the manufacturer, and all repairs shall be done as indicated by the operating procedure of the manufacturer.

WARNING: It is agreed and accepted that the use of the equipment (system) is limited to a maximum of two people.

- k) Do not exceed 360 lbs. (164 kg) per anchor point, equivalent to the system's maximum working load
- l) Follow all applicable laws, regulations and standards for work in, entry in and exit from confined spaces.
- m) A person who has not read this instruction and safety manual, has not been trained in using the XTIRPA system and does not understand all operation, safety, maintenance, servicing and storage instructions contained in this instruction and safety manual and in any other recommendations provided by the manufacturer or its certified trainers is not qualified to operate the XTIRPA system and does it at their sole risk, therefore waiving any and all claims, rights and recourses against the manufacturer and derived therefrom.
- n) Make sure to conform to relative demands regarding anchoring devices (E.g.: floor adapter, wall adapter, built-in, etc.) or ensure that the chosen structure that will be used has an anchoring point, and keep in mind minimal required resistance, equivalency and position.

WARNING: Anchoring devices must be installed only by competent persons or organizations.

- o) The maximum force applied by the system on the structure is, a vertical force of 13 kN, per EN 362, EN 795:2012 CE and TS 16415:2013 on the anchor where the system is deposited.

WARNING: The system must be appropriately checked, for example, by calculations or tests.

WARNING: The use of a base, structural anchor or fastener, if one exists, must be taken into account when calculating the amount of force supported by the anchor during strength and integrity testing.

- p) A rescue plan shall be put in place in order to account for all likely emergencies that could occur while working.

WARNING: Any modification or addition to the equipment cannot be done without the prior written consent of the manufacturer, and any repairs must be undertaken in accordance with the manufacturer's procedures.

WARNING: It is agreed and accepted that the use of the equipment (system) is limited to a maximum of two people.

WARNING: It is important to place the XTIRPA system on a hard and level surface. Do not use the XTIRPA system on a soft surface, including, but not limited to, sand, grass, gravel and rocks. If you have any questions about use or maintenance or whether the XTIRPA system is appropriate for your job, please contact the Manufacturer PSP INNOVA INC.

WARNING: For safety reasons, make sure when using the anti-drop system that you have enough space under the user, so as to avoid injury. If a fall occurs, there should be enough space to avoid a collision with the ground or any obstacle. See the diagram in Section 8 for calculating this distance.

IMPORTANT: It is imperative to respect the mounting compatibilities identified in chapter 5.
Only the assemblies shown inside this manual are authorized.

XTIRPA SYSTEM REQUIREMENTS

IMPORTANT: If you have questions on the use, care or suitability of the XTIRPA system for your application, please contact the Manufacturer INNOVA Public Utility Products Inc.

IMPORTANT: Record the product identification information from the ID label in the maintenance and inspection log of this Instruction and safety manual.

IMPORTANT: Record purchasing date and also date of first use on the maintenance and inspection log sheet included in this safety instruction manual.

IMPORTANT: During use, the coupling system must be kept level by using the adjustable support legs. Make sure that the support legs can support the weight at all times.

- a) The XTIRPA system is intended to be used as part of a personal fall arrest, work positioning, personnel riding, material handling, or rescue system for use in confined spaces and act as a support structure or anchorage. The XTIRPA system must be used only with adapters, anchors, connectors, other components, parts or subsystems certified, approved and recommended by the manufacturer.

WARNING: It is imperative to never use this system, both with personnel and for material handling purposes.

- b) Substitutions or replacements made with non-approved adapters, anchors, connectors, other components, parts or subsystems may be incompatible, may jeopardize the safety and reliability of the complete XTIRPA system and may result in serious injury or death, for which the manufacturer disclaims all warranties and liabilities whatsoever, user, owner and purchaser of the XTIRPA system waiving all claims, rights and recourses against the manufacturer derived therefrom.
- c) The connector (EN 362) (hooks, snap hooks, D-rings) must meet the standard EN 362.
- d) Make sure the lifeline cable or rope is positioned directly over the work area. Use only certified lifeline cable or rope, in perfect working condition, with appropriate specifications, including maximum leverage capabilities, for the intended use of the XTIRPA system.
- e) Owners must make sure that, before each use, all users of the XTIRPA system have read, understood and follow the manufacturer's Instructions and safety manual.
- f) Owners must also make sure that all users have successfully been trained in using the XTIRPA system, before allowing them to use the XTIRPA system, and at least annually thereafter.
- g) The vehicle coupling system must be positioned directly over the work area.

IMPORTANT: During use, the extendable coupling system for vehicles and XTIRPA counterbalanced trucks must be raised completely with the adjustable support legs. The moving wheels must never be in contact with the ground.

- h) A person who has not read the instruction and safety manual, has not been trained in using the XTIRPA system and does not understand all operation and safety instructions, is not qualified to operate the XTIRPA system. An untrained user exposes himself and others to possible serious injury or death, for which the manufacturer disclaims all warranties and liabilities whatsoever, user, owner and purchaser of the XTIRPA system waiving all claims, rights and recourses against the manufacturer derived therefrom.
- i) Refer to and follow all the EN standards as well as other local standards and regulations. Follow all requirements of your local regulations regarding your operations.
- j) See other important operation instruction and safety information contained hereafter in this instruction and safety manual.
- k) It is imperative to supply all information in sufficient quantity to assure that different equipment articles are compatible when assembled as a system.

WARNING: It is possible that a hazard may occur while using multiple components, as one of them could affect the safety function of the system, if the safety function of one component can be affected by that of another component.

WARNING: It is essential for the safety of the user, if the product is resold to a destination outside the first country, that the reseller supplies the instruction manual, maintenance instruction log sheet for the periodic inspections and all associated repair instructions written in the native language of the country in which the product will be used. It is also required to supply all specific additional information for the equipment.

WARNING: Any persons with a medical condition which could cause a hazard to the user during normal operation and in emergency situations should avoid using the system.

- l) Life expectancy of the XTIRPA system and its components will be determined based on the conclusions of periodic and monthly inspections which will determine whether or not the product may remain in service.

WARNING: If the system has been used to stop a fall, it should not be used again until a competent person has, in writing, authorized its reuse.

WARNING: The safety of the user is in direct relation to the quality of maintenance and integrity of the equipment.

- m) Always use a bubble level to ensure that the system is level.

WARNING: When using a counterbalanced truck, all the instructions regarding the weights required for specific applications must be followed. (see table below)



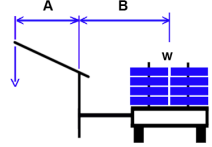

©2005-022_revF

A		B		W		
mm	in	mm	in	23 kg (50 lb)	kg	lb
610	24	1537	61	20	454	1000
		2367	93	12	272	600
1219	48	2419	95	24	544	1200

MAINTENANCE, SERVICING, STORAGE

- a) Before each use, the user must read and understand the Manufacturer's Instruction and safety manual. Ensure that the markings are visible at all times.
- b) Before each use, carefully inspect the XTIRPA system and all components and parts thereof. Any defective parts or components could result in serious injury or death.
- c) The standards require a regular inspection program for any entrance/recuperation equipment in closed space, as well as keeping the documented results of these inspections up to date. Use the maintenance and inspection sheet included in this Instruction and Safety Manual to document your results.
- d) It is recommended that the anchoring device be marked with the most recent or next inspection date.
- e) Remove the XTIRPA system from service if a problem or an unsafe or defective condition is found during the inspection. Return to an authorized service center or the manufacturer for service.
- f) Replacement components and parts and additional maintenance and servicing procedures must be completed by an authorized service center which has been approved by the manufacturer, or by the manufacturer itself.
- g) If the adjustable support legs of the coupling system for vehicles and counterbalanced trucks do not move freely, they must be lubricated with a light machine oil.
- h) Establish a monthly inspection which should be done by a competent person (person who is familiar, has been trained and has read and fully understands this instruction and safety manual), other than the user.
- i) Periodically clean the exterior of the davit arm and base, using water and mild detergent. Clean labels as required.

WARNING: A periodic inspection must take place at least once every twelve months.

- j) When lowering the removable system, it is important to slowly place the system on the ground, to avoid damaging components.
- k) Store the XTIRPA system in a clean and dry environment, out of direct sunlight. Avoid areas with chemical or toxic vapors, substances or environments. Do not immerse or leave in direct contact with water, as corrosion and rust may occur. Inspect the XTIRPA system after any period of extended storage and at least once a month.
- l) The XTIRPA system and its components was designed for 10 years of continuous service. The life expectancy of the XTIRPA system and its components will be determined after periodic and monthly inspections that will determine whether or not the product may remain in service.
- m) All components and parts of the XTIRPA system should be stored in separate bags to facilitate transport and handling.

WARRANTY

The XTIRPA system offered by the Manufacturer, INNOVA Public Utility Products Inc., is warranted against manufacturing defects in workmanship and materials for a period of two (2) years from the date of shipment of the product, which warranty only covers the original purchaser of the XTIRPA system. The Manufacturer will promptly repair or replace all components or parts found to be defective, the Manufacturer reserving the right to elect to have any alleged defective part returned to its plant for inspection before making a repair or replacement.

Only components or parts found to be defective by the Manufacturer, at its sole discretion and upon any inspection requested and performed by the Manufacturer, will either be repaired or replaced by the Manufacturer, at its sole choice.

All claims must be forwarded in writing to the Manufacturer, immediately upon discovery by owner, and must be accompanied by a copy of the proof of purchase of the original purchaser. Manufacturer will issue a claim's number and give specific instructions to be followed as to claim's procedures and return of the defective part, if so requested by the Manufacturer. Owner will collaborate with Manufacturer and its representatives to allow inspection of any alleged defective part. All shipping costs to return defective components and parts to the Manufacturer's plant are payable by owner, the cost of reshipping replacement components or parts being covered by the Manufacturer.

This warranty does not cover equipment damages resulting from any other cause than a manufacturing defect in workmanship or materials, including, without limitation, damages resulting from abuse, lack of maintenance, improper handling or storage, voluntary damages, vandalism, accidental damages or damages resulting from impact or collision, damage in transit, damages caused by fire, explosion, chemical, toxic or corrosive vapors, substances or environments, water, normal corrosion and rust, storms, hail, and other acts of God, war insurrection, acts of terrorism or other damage beyond the control of the Manufacturer. This warranty applies only to the original purchaser and is the only one applicable to the XTIRPA system, and is in lieu of all other warranties, expressed or implied. Without limiting the generality of the foregoing, the Manufacturer will not be liable nor responsible for any other cost, damages or claims whatsoever, including for any special, incidental, indirect, or consequential damages whatsoever such as, but not limited to, damages for loss of profits or expected revenues, for business interruption, for personal injury, for failure to meet any duty including of good faith or of reasonable care, for negligence, and for any other pecuniary or other loss whatsoever, arising out of or in any way related to the use of or inability to use the XTIRPA system, even in the event of the fault, tort (including negligence), strict liability, breach of contract or breach of warranty, even if the Manufacturer has been advised of the possibility of such damages. The Manufacturer hereby disclaims all other warranties and conditions, either express, implied or statutory, including, but not limited to, any implied warranties or conditions of merchantability, of fitness for a particular purpose or application, and of lack of negligence or lack of workmanlike effort.

IMPORTANT: The buyer must fill out and return the Limited Warranty registration form for each product.

XTIRPA SYSTEM DESCRIPTION

WARNING

The XTIRPA system is part of a personal fall arrest, work positioning, personnel handling, material handling or rescue system for use in confined spaces. The XTIRPA system is intended to act as a support structure or anchor for these uses. The user must read, understand and follow the manufacturer's instructions for each component or part of the complete XTIRPA system. These instructions must be provided to the user of the XTIRPA system. The user must read and understand these instructions before using the XTIRPA system. The manufacturer's instructions must be followed for proper use and maintenance of the XTIRPA system. Alterations or misuse of the XTIRPA system or failure to follow instructions may result in serious injury or death, for which the Manufacturer disclaims all warranties and liabilities whatsoever, user, owner and purchaser of the XTIRPA system waiving all claims, rights and recourses against the manufacturer and derived therefrom.

IMPORTANT: It is imperative to respect the mounting compatibilities identified in chapter 5.

*****Only the assemblies shown inside this manual are authorized.*****

DESCRIPTIONS: (See illustrations on following page)

- EXTENDABLE COUPLING SYSTEM FOR VEHICLES: IN-2126 / IN-2204 (see illustration 1)
- DAVIT ARM WITH SECONDARY BLOCK 610mm (24") : IN-2210 (see illustration 2)
- 76MM (3") MAST FOR DAVIT ARM IN-2210 : IN-2003 (see illustration 3)
- TYPICAL SET: IN-8007 (see illustration 4)
- UNIVERSAL VEHICLE COUPLING JOINT : A2126-07 (see illustration 5)
- 1829MM (72") EXTENSION FOR VEHICLE COUPLING : A2126-09 (see illustration 6)
- 90° EXTENSION FOR VEHICLE COUPLING: A2126-10 (see illustration 7)
- ADAPTER FOR COUNTERBALANCED TRUCK 51MM-89MM (2"-3.5") : A2126-38 (see illustration 8)
- ANCHORING ADAPTER FOR VEHICLE COUPLING : A2126-21 (see illustration 9)
- C-CLAMP FOR VEHICLE COUPLING : A2126-14/ A2126-33 (see illustration 10)
- COUNTERBALANCED TRUCK : A2305-07 (see illustration 11)
- UNIVERSAL WALL ADAPTER FOR VEHICLE COUPLING : IN-2348 (see illustration 12)
- 90° 8" (213 MM) UNIVERSAL ADAPTER EXTENSION IN-2348 : A2348-03 (see illustration 13)
- 90° 12" (305MM) UNIVERSAL ADAPTER EXTENSION IN-2348 : A2348-05 (see illustration 14)
- ATTACHMENT BRACKET FOR BEAM 3-3/4" MAX. : A2348-08 (see illustration 15)
- REINFORCED REDUCER TUBE 2-1/2" TO 2" (ACCS.) : A2126-57 (see illustration 16)
- BALLAST SUPPORT ASSEMBLY: A2305-65 (see illustration 17)
- ADAPTATEUR POUR ATTELAGE DE VÉHICULE EUROPÉEN: IN-2517 (see illustration 18)
- EXTENSION 900MM (36") FOR COUPLING (HITCH) DEVICE FOR MOTOR VEHICLES: a2126-69 (see illustration 19)
- COUNTERWEIGHT TROLLEY WITH FALL ARREST: IN-2525 (illustration 20)
- COUNTERWEIGHT SUPPORT: a2305-90 (illustration 21)

Illustration 1
IN-2126 / IN-2204



Illustration 2
IN-2210



Illustration 3
IN-2003



Illustration 4
IN-8007



Illustration 5
A2126-07



Illustration 6
A2126-09

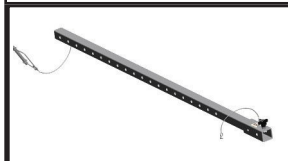

Illustration 7
A2126-10



Illustration 8
A2126-38

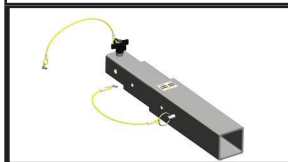

Illustration 9
A2126-21



Illustration 10
A2126-14/A2126-33

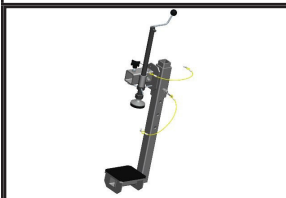

Illustration 11
A2305-07



Illustration 12
IN-2348

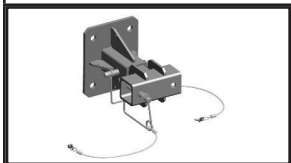

Illustration 13
A2348-03

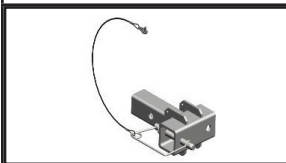

Illustration 14
A2348-05



Illustration 15
A2348-08



Illustration 16
A2126-57



Illustration 17
A2305-65

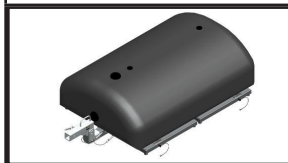

Illustration 18
IN-2517

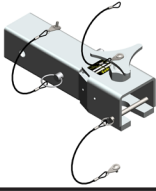

Illustration 19
A2126-69

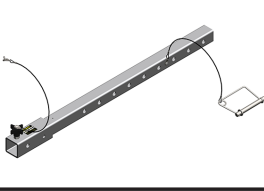

Illustration 20
IN-2525

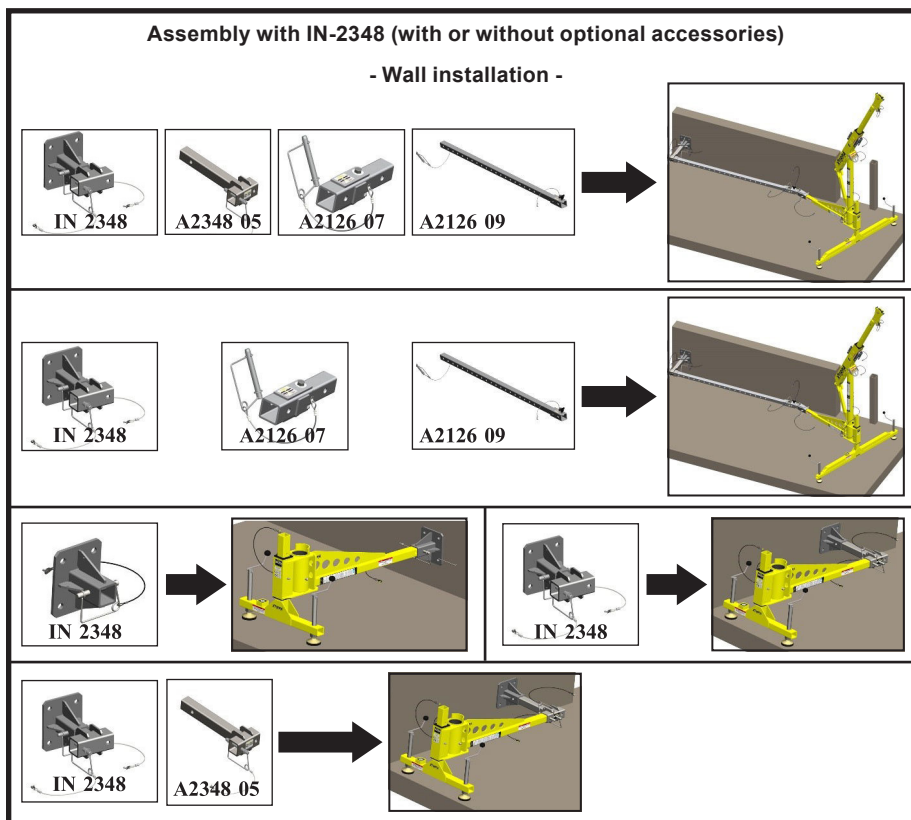
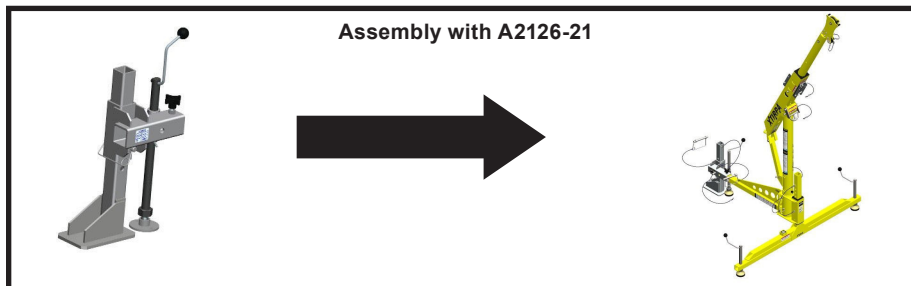
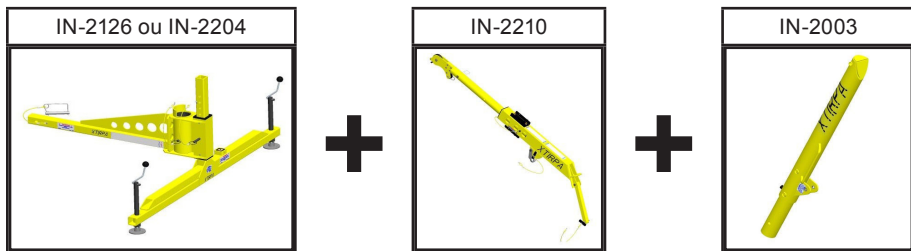

Illustration 21
A2305-90



Assembly compatibility for TYPE A

↓ Typical composition ↓



- Wall installation (cont.) -

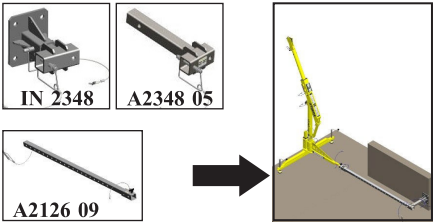
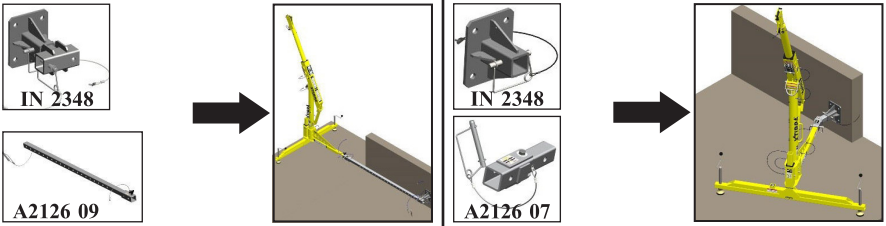
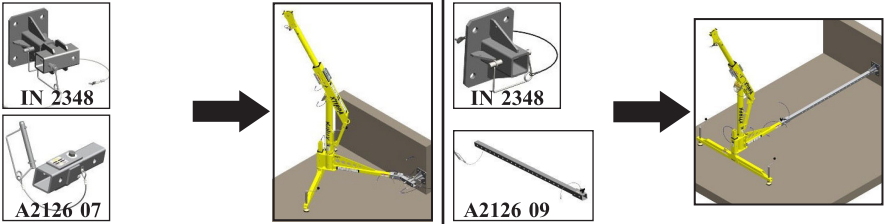
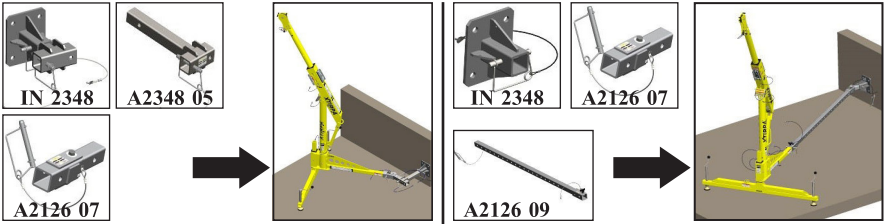

For installation on a column, use above configurations

- Column installation -

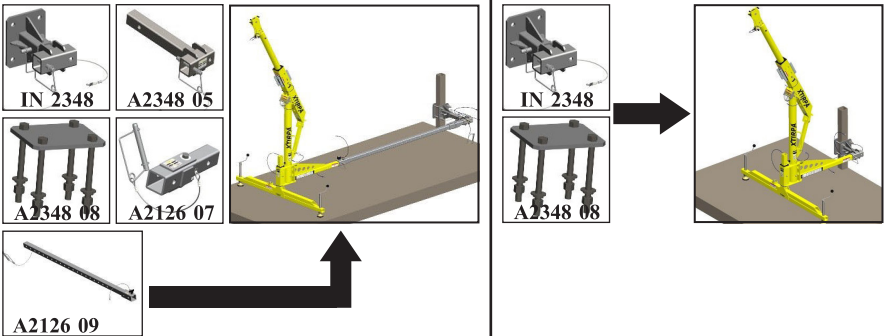

Assembly compatibility for TYPE B

Assembly with A2126-14 or A2126-33 (Without extension)

IN-2126 ou
IN-2204

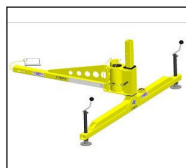

IN-2210



IN-2003



A2126-14 /
A2126-33

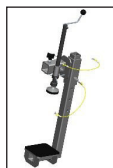

Assembly with A2126-14 or A2126-33 (With extension)

IN-2126 ou
IN-2204



IN-2210



IN-2003



A2126-14 /
A2126-33

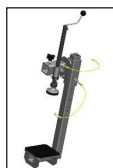

A2126-29

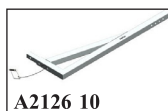
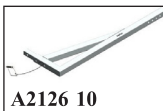

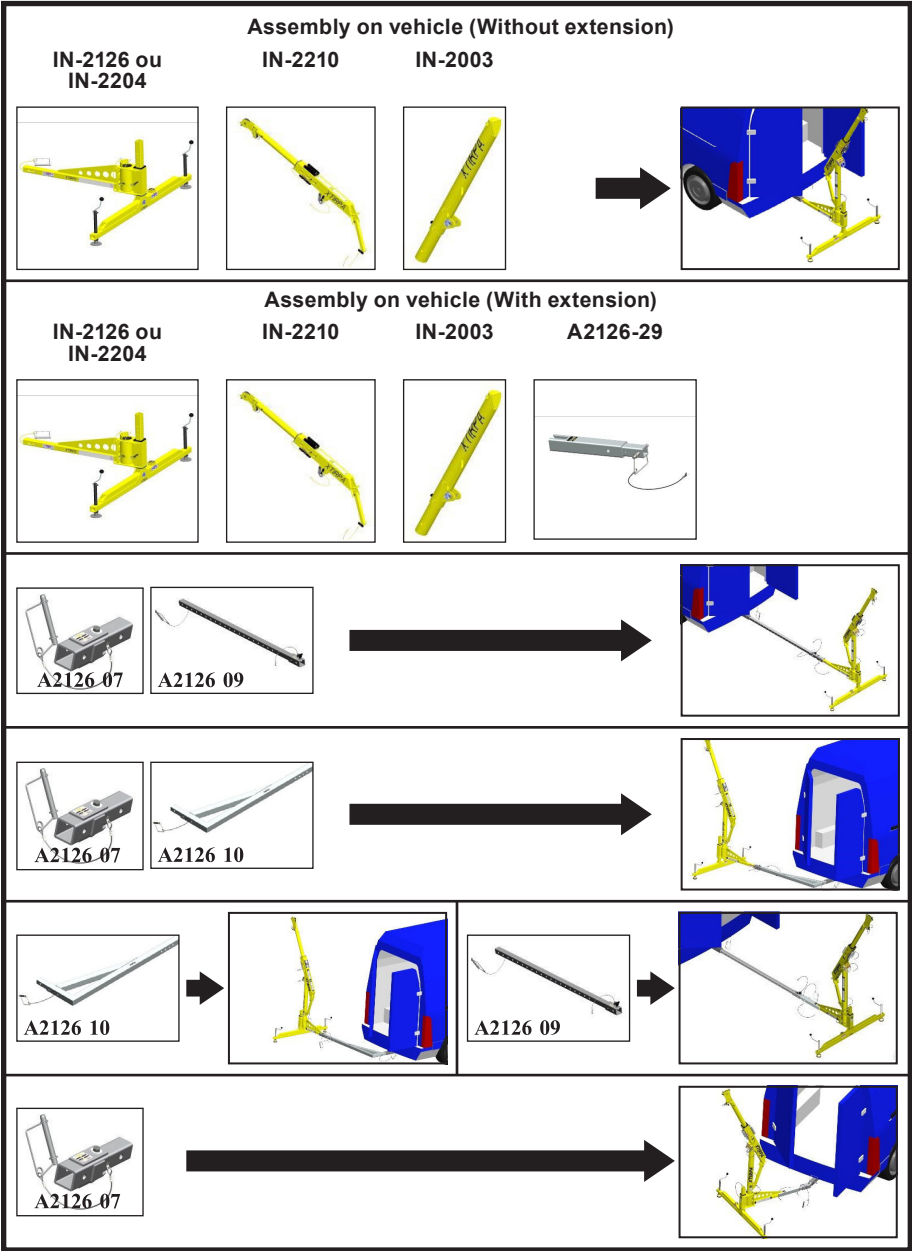

Assembly compatibility with TYPE E

↓ Typical composition ↓

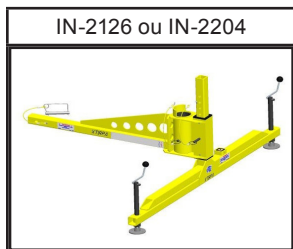

Mounting with A2305-07

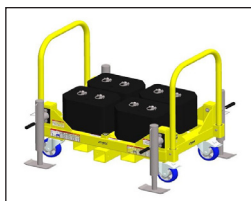

A2305-07

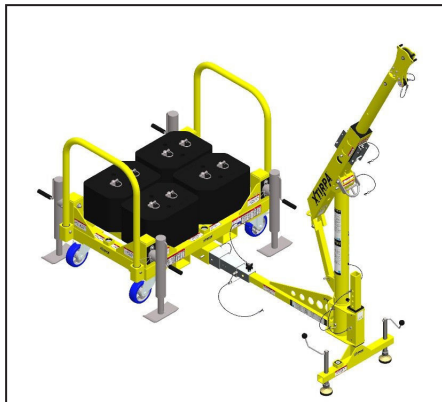
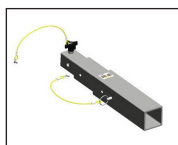

Mounting with A2305-65



A2305-07

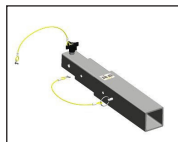

↓ Typical composition (follow-up) ↓

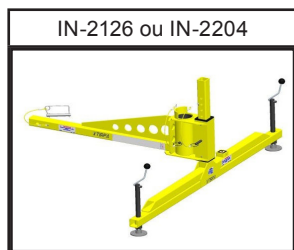

Mounting with A2305-07

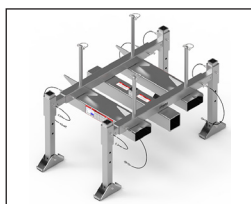

A2305-07

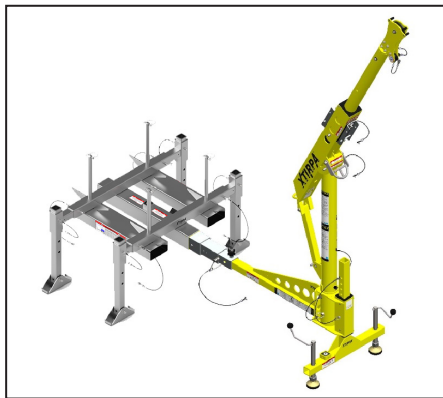
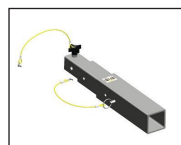

Mounting with A2305-65

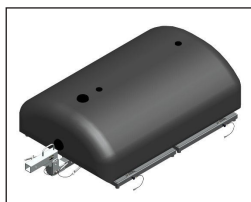

A2305-65

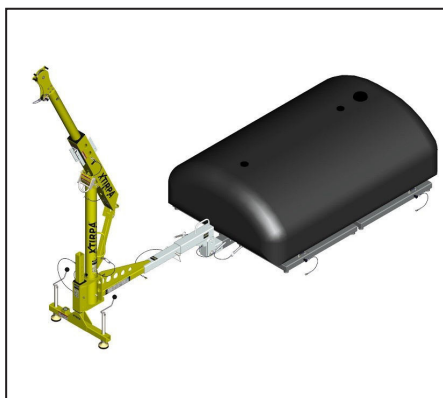
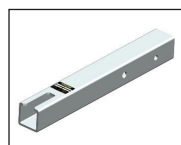

-6-

OPERATION, ASSEMBLY AND USE

XTIRPA SYSTEM

WARNING: The XTIRPA system is part of a personal fall arrest, work positioning, personnel handling, material handling or rescue system for use in confined spaces. The XTIRPA system is intended to act as a support structure or anchor for these uses. The user must read, understand and follow the manufacturer's instructions for each component or part of the complete XTIRPA system.

WARNING: These instructions must be provided to the user of the XTIRPA system. The user must read and understand these instructions before using the XTIRPA system. The manufacturer's instructions must be followed for proper use and maintenance of the XTIRPA system. Alterations or misuse of the XTIRPA system or failure to follow instructions may result in serious injury or death, for which the Manufacturer disclaims all warranties and liabilities whatsoever, user, owner and purchaser of the XTIRPA system waiving all claims, rights and recourses against the manufacturer and derived therefrom.

IMPORTANT: If you have questions on the use, care or suitability of the XTIRPA system for your application, please contact the Manufacturer INNOVA Public Utility Products Inc.

IMPORTANT: Record the product identification information from the ID label in the maintenance and inspection log of this instruction and safety manual.

1. Make sure that all components and parts are in perfect working order and that everything is functioning correctly. The weight of the vehicle must be greater than or equal to 2727 kg (5000 lb).

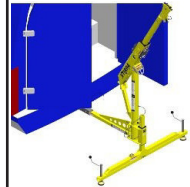

2. Insert 50.8mm x 50.8mm (2"x2") tube or any other adapter or connector that has been certified, approved and recommended by the manufacturer into the trailer hitch receptacle.

****The weight of the vehicle must be greater than 2727 kg (5000 lb)****



3. Make sure that the tube or other certified, approved and recommend adapter is locked with the locking pin.



IMPORTANT: Ensure that all locking pins are firmly in place.

OPERATION AND INSTALLATION OF TRAILER HITCH SYSTEM WITH UNIVERSAL WALL ADAPTER IN-2348

1. Make sure that all components and parts are in perfect working order and that everything is functioning correctly.

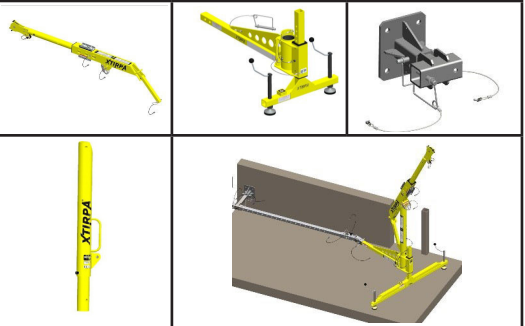

2. Insert 50.8mm x 50.8mm (2"x2") tube or any other adapter or connector that has been certified, approved and recommended by the manufacturer into the universal wall adapter receptacle.

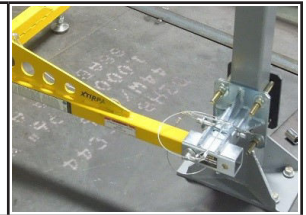



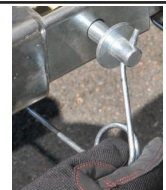



3. Make sure that the tube or other certified, approved and recommend adapter is locked with the locking pin.



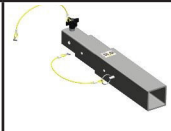

IMPORTANT: Ensure that all locking pins are firmly in place.



OPERATION AND INSTALLATION OF TRAILER HITCH SYSTEM WITH COUNTERBALANCED TRUCK (A2305-07)

1. Make sure that all components and parts are in perfect working order and that everything is functioning correctly.			
			

1. A. Determine the placement of the truck. B. Remove the pins from the leveling supports and rotate them into a vertical position.		
		







2. A. Adjust the leveling supports. B. Using a bubble level, ensure that the bubble is in the center of the indicator.		
--	---	---



WARNING: During use, the counterbalanced truck must be raised so that the wheels are not in contact with the ground, only the leveling supports.



3. Insert A2126-38 adapter into receptacle in center of truck and lock with pin.		
---	---	---

IMPORTANT: Ensure that all locking pins are firmly in place.



OPERATION AND INSTALLATION OF TRAILER HITCH SYSTEM WITH COUNTERBALANCED TRUCK (IN-2525)

1. Make sure that all components and parts are in perfect working order and that everything is functioning correctly.			
			

2. A. Determine the placement of the truck. B. Remove the pins from the leveling supports and rotate them into a vertical position.		
		



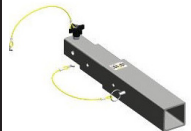



3. A. Adjust the leveling supports. B. Using a bubble level, ensure that the bubble is in the center of the indicator.		
--	---	---

WARNING: During use, the counterbalanced truck must be raised so that the wheels are not in contact with the ground, only the leveling supports.

4. Insert A2126-38 adapter into receptacle in center of truck and lock with pin.		
---	---	---

IMPORTANT: Ensure that all locking pins are firmly in place.

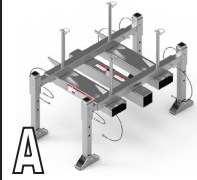
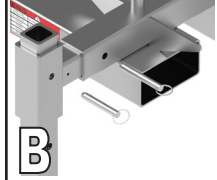

OPERATION AND INSTALLATION OF TRAILER HITCH SYSTEM WITH COUNTERBALANCED TRUCK (A2305-90)

1. Make sure that all components and parts are in perfect working order and that everything is functioning correctly.			
			

2. A. Determine the placement of the truck. B. Remove the pins from the legs to adjust the trolley's level.		
---	---	---







3. Use the level indicator and make sure that is right in the center of the indicator.	
---	---

The XTIRPA system must be placed on a hard and level surface. Do not use the XTIRPA system on soft ground, such as, but not limited to, sand, grass, gravel and pebbles. If you have any questions related to the use, maintenance or suitability of the XTIRPA system for your operations, please contact the Manufacturer, PSP INNOVA INC.

4. Insert A2126-38 adapter into receptacle in center of truck and lock with pin.		
---	---	---



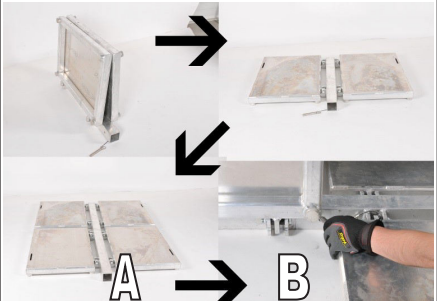

IMPORTANT: Ensure that all locking pins are firmly in place.

OPERATION AND INSTALLATION OF TRAILER HITCH MOUNT SYSTEM WITH BALLAST SUPPORT ASSEMBLY (A2305-65)

<p>1. Make sure that all components and parts are in perfect working order and that everything is functioning correctly.</p>			
			

<p>2. A. Assemble the two parts of the tank platform. B. Attach the two parts of the platform with pin.</p>	
--	---

<p>3. Attach the water tank with the 4 pins situated on the edges of the platform.</p>	
---	---

<p>4. A. Insert extension on the front of the platform. B. Lock with the pin. C. If necessary, adjust the angle +/- 5 degrees. D. Lock angle with pin.</p>		
		

- 5.** **A.** Insert the adapter (A2126-57), with the groove face up, into the platform's adapter and lock with pin.
B. Insert the extendable vehicle coupling system (IN-2126 / IN-2204) into the adapter and lock with pin.

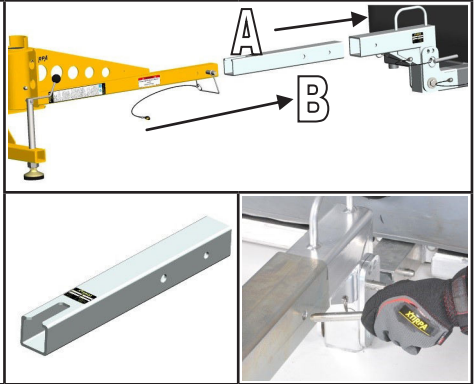

IMPORTANT: Ensure that all locking pins are firmly in place.

LEVELING THE TRAILER HITCH SYSTEM

- 1.** Remove locking pin and adjust the height of the trailer hitch so that the mast receptacle is in a horizontal position. Proceed to stabilize the system with the adjustable support legs (**A**). Make sure that the level bubble is in the center of the indicator (**B**).

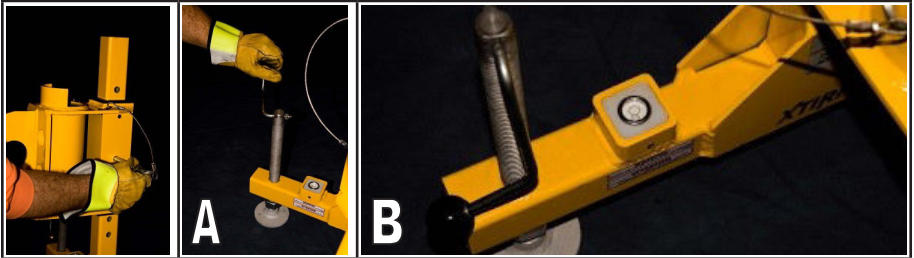

INSTALLATION OF MAST AND DAVIT ARM WITH VEHICLE COUPLING SYSTEM

- 1.** Insert mast into mast receptacle and lock with pin.

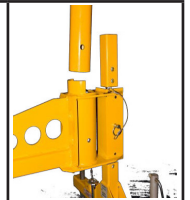

- 2.** Remove the two handle pins from their location (**A**, **B**). Next, install the davit arm receptacle on the mast.

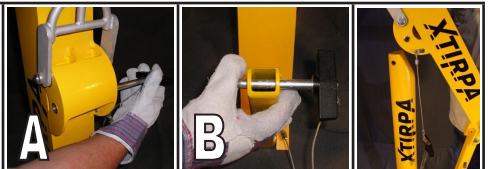

3. Lock all with the first handle pin (A), then install the inferior leg of the davit arm between the eyelets of the mast and lock with the second handle pin (B).

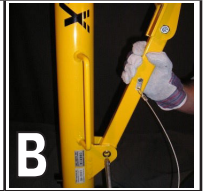

4. Install the lifeline cable or rope or winch on mounting bracket made to accept the hoisting device. Pass the lifeline cable or rope through the pulley located at the top end of the davit arm. Make sure that the cable or rope is securely in place.



5. A second lifeline can be installed on the grey "D" anchor point.



6. Pass the lifeline cable or cord or winch through the pulley at the end of the davit arm. Make sure that the cable or cord has been passed through securely and is well in place.



WARNING: Never use a winch or lifeline for fall protection when positioned below the davit arm.

WARNING: Only adaptors and brackets that are approved, certified and recommended by the manufacturer are to be used with the XTIRPA system.

7. If a material / positioning winch is required, use the bottom mounting bracket located under the davit arm. Install winch to mounting bracket and lock with pin attached to winch. **(A)**. Remove the small pulley locking pin. Position cable over pulley and re-install pulley using locking pin. **(B)**.

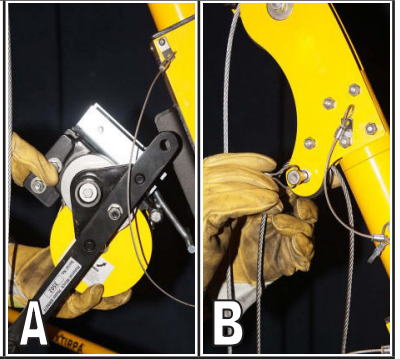

8. Remove locking pin located in the mid section of the davit arm. **(A)**. Extend the inner mast to full extension **(B)** Replace locking pin to secure the davit arm **(A)**.

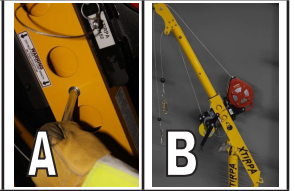

IMPORTANT: Make sure that the lifeline cable or rope is directly positioned above the working area. Only use certified lifeline cables or ropes in perfect condition, that have the appropriate specifications, including maximum lifting capacity, for the intended use of the XTIRPA system.

WARNING: It is important to place the XTIRPA system on a hard and level surface. Do not use the XTIRPA system on a soft surface, including, but not limited to, sand, grass, gravel and rocks. If you have any questions about the use or maintenance or whether the XTIRPA system is appropriate for your job, please contact the Manufacturer PSP INNOVA INC.

CAUTION: It is important to never position the XTIRPA system in zones where water can accumulate and create a hazard.

IMPORTANT: If necessary, secure the work area with a manhole guard to prevent falls.

IMPORTANT: A harness in accordance with EN 361 is the only body support device allowed to be used for fall protection.

WARNING: The instruction and safety manual must be followed for proper use and maintenance of this product. Alterations or misuse of the XTIRPA system or of any component or part thereof or failure to follow instructions may result in serious injury or death, for which the manufacturer disclaims all warranties and liabilities whatsoever, user, owner and purchaser of the XTIRPA system waiving all claims, rights and recourse.

WARNING: Any system must be immediately removed from circulation if its safety is questioned, or if it was used to stop a fall. It is imperative not to use the system before a competent person authorizes in writing the integrity of the product before its reuse.



WARNING: For all fall protection devices, it is essential, for safety purposes, that anchoring device is always positioned correctly and that the task to be performed should be done in a manner to reduce risk of fall and height of fall. The anchoring point and fall protection device must be placed directly over the user's position.

CAUTION: The XTIRPA system must only be used with adaptors, anchors, connectors (EN 362), pulleys and other components, parts or sub-systems certified, approved and recommended by the Manufacturer. Any substitution or replacement of adaptors, anchors, connectors (EN 362), other components, parts or sub-systems may be incompatible, may jeopardize the security and reliability of the entire XTIRPA system and may lead to serious injury or death, for which the Manufacturer refuses any warranty or responsibility, the user, owner and buyer of the XTIRPA system waiving any arising claim, right and remedy against the Manufacturer. All connectors (EN 362) (hooks, snap hooks, D-rings) must meet the standard EN 362.



CAUTION: When users are thinking about connecting a personal protective equipment against falls to Type E anchoring devices, the users should first seek the advices of the Manufacturer of the personal protective equipment against falls on its suitability and fitness.

KEEP THE FOLLOWING INSTRUCTIONAL AND SAFETY SIGNS CLEAN AND LEGIBLE AT ALL TIMES



XTIRPA
IN-2210



x2











x2



- EN 795.2012 Type A
- TS 16415.2013
- EN 795.2012 Type B, Type E

2927

Products manufactured by:
Innovy Public Utility Products Inc.
1040 Foxit Industrial
Granby, QC, Canada J2J 1A1
www.xtirpa.com

s2210-101_revL Made in Canada

Accredited standard No.

Product standard information

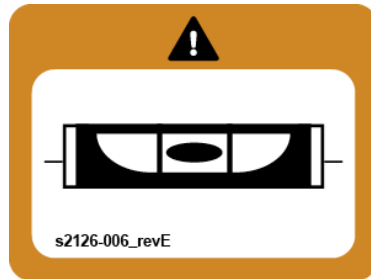
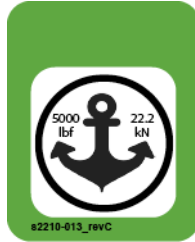

SERIAL NUMBER LABEL

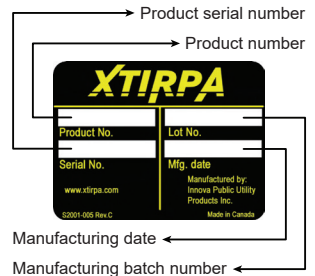

!

A		B		W		
mm	in	mm	in	23 kg (50 lb)	kg	lb
610	24	1537	61	20	454	1000
		2367	93	12	272	600
1219	48	2419	95	24	544	1200

s2305-022_revF

!

s2118-003_revE

s2126-040_revA

s2204-001_revH

-8-
CALCULATION DIAGRAM

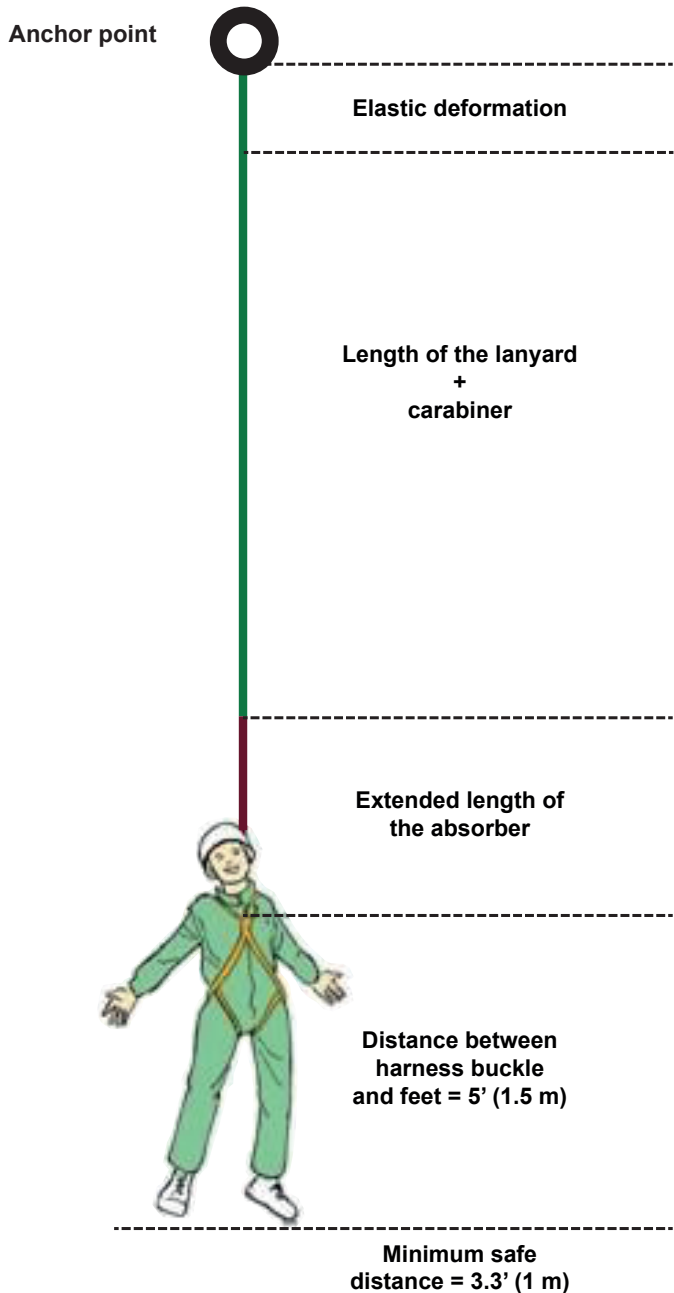

Product: _____ Purchasing date: _____

Model number: _____ Serial number: _____ Manufacturing date: _____

Date of next inspection: _____ Date of 1st use: _____

INSPECTION DATE	LABELS	CORROSION	STRUCTURAL DAMAGE	WELDING	PINS & HARDWARE	OTHER (SPECIFY)	CORRECTIVE ACTION TAKEN (if required)	INSPECTED BY:
	<input type="checkbox"/>	<input type="checkbox"/>	<input type="checkbox"/>	<input type="checkbox"/>	<input type="checkbox"/>			
	<input type="checkbox"/>	<input type="checkbox"/>	<input type="checkbox"/>	<input type="checkbox"/>	<input type="checkbox"/>			
	<input type="checkbox"/>	<input type="checkbox"/>	<input type="checkbox"/>	<input type="checkbox"/>	<input type="checkbox"/>			
	<input type="checkbox"/>	<input type="checkbox"/>	<input type="checkbox"/>	<input type="checkbox"/>	<input type="checkbox"/>			
	<input type="checkbox"/>	<input type="checkbox"/>	<input type="checkbox"/>	<input type="checkbox"/>	<input type="checkbox"/>			
	<input type="checkbox"/>	<input type="checkbox"/>	<input type="checkbox"/>	<input type="checkbox"/>	<input type="checkbox"/>			
	<input type="checkbox"/>	<input type="checkbox"/>	<input type="checkbox"/>	<input type="checkbox"/>	<input type="checkbox"/>			
	<input type="checkbox"/>	<input type="checkbox"/>	<input type="checkbox"/>	<input type="checkbox"/>	<input type="checkbox"/>			
	<input type="checkbox"/>	<input type="checkbox"/>	<input type="checkbox"/>	<input type="checkbox"/>	<input type="checkbox"/>			
	<input type="checkbox"/>	<input type="checkbox"/>	<input type="checkbox"/>	<input type="checkbox"/>	<input type="checkbox"/>			

COMMENTS: _____

*Any failure to follow the Manufacturer's instructions contained in the instruction and safety manual, including with regard to the inspection and maintenance of the XTIRPA system and of components and parts there of, will cause warranty to become null and void and may result in serious injury or death of the user, for which the Manufacturer disclaims all warranties and liabilities whatsoever, user, owner and purchaser of the XTIRPA system waiving all claims, rights and recourses against Manufacturer and derived there from.

XTIRPA™

CONFINED SPACE SAFETY SOLUTIONS

Head Office and Manufacturing Plant

Innova Public Utility Productions Inc.
1040, Boulevard Industriel
Granby, Qc, Canada
J2J 1A4

Phone: 450.777.1240
Toll free: 1.800.461.1937

www.xtirpa.com



Xtirpa is a registered trademark of
Innova Public Utility Productions Inc.
used under license in Canada

MU8007-EN-(en-us)_rev5.01