

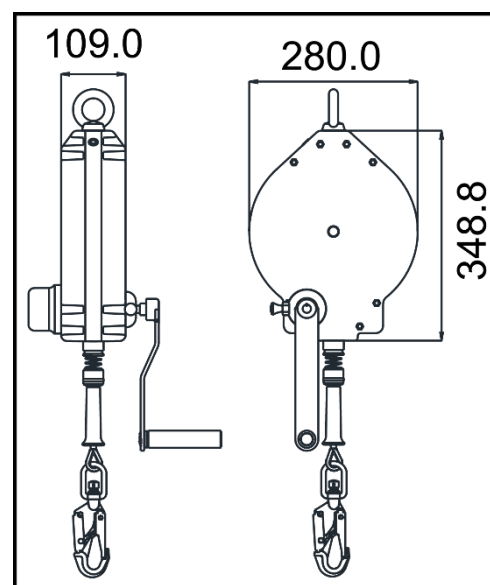















# Olympe



HS CODE
84253900
CARTON SIZE / PCS.
60 x 36 x 34.5 cm / 1
AET N°2777/14354-01/E02-01
<b>Satra Technology Europe Ltd., N° 2777,</b> Bracetown Business Park, Clonee, Dublin, D15YN2P, Ireland
MODULE D FI14/14003.02
<b>SGS Fimko Oy, N°0598</b> Takomotie 8, 00380 HELSINKI, Finland
ACKNOWLEDGEMENT OF RECEIPT N°3975/1/2018 (ATEX)
<b>Technická Inšpekcia, a.s. N°1354</b> Trnavská cesta 56, 821 01 Bratislava, Slovenská Republika

REF.	FA 20 401 30	FA 20 401 30S
LG.  KG	30 m	
CE	EN 360:2002, EN 1496 :2017 Class B	
MAT. 	Polyamide 6 - 30% fiber glass	
	 <b>STEEL</b> Ø 4.5 mm	 <b>INOX</b> Ø 4.5 mm
	 FA 50 101 17 / FA 50 203 20 with fall indicator	 FA 50 101 17 / stainless steel connector with fall indicator
	x2	
R(kN)	12 kN	
	NO	
+	(1) ATEX Directive 2014/34/UE  II 2 G Exh IIC T6 Gb (2) FA 60 001 02, FA 60 101 01	
	14.80 KG	

LG.  KG	MAT. 		
Longueur Poids maxi utilisateur <b>Length</b> Max. user weight Longitud Peso máximo del usuario Lunghezza Peso Max. dell'utente Länge Höchstgewicht des Benutzers	Matière carter / câble Material of casing / wire rope <b>Material cárter / cable</b> Material dei carter / Cavo <b>Material Gehäuse / Seil</b>	Matière connecteur haut / connecteur bas Material of top connector / bottom connector <b>Material conector alto / conector bajo</b> Materiale connettore alto / connettore basso <b>Material oberes / unteres Verbindungselement</b>	Nombre d'émerillons Number of swivels <b>Cantidad de eslabones giratorios</b> Numero di tornichetti <b>Anzahl der Wirbel</b>
	+	+	+
Homologué pour le travail à proximité d'arêtes vives Approved for work near sharp edges <b>Homologado para trabajo cerca de aristas vivas</b> Omologato per lavoro in prossimità di spigoli vivi <b>Zugelassen für Arbeiten in der Nähe scharfer Kanten</b>	(1) <b>Point fort</b> Key feature <b>Ventaja principal</b> Punti forti <b>Produktvorteil</b>	(2) <b>À utiliser avec</b> To be used with <b>Para usar con</b> Ad essere utilizzato con <b>Verwendet werden soll mit</b>	