

I|S|C

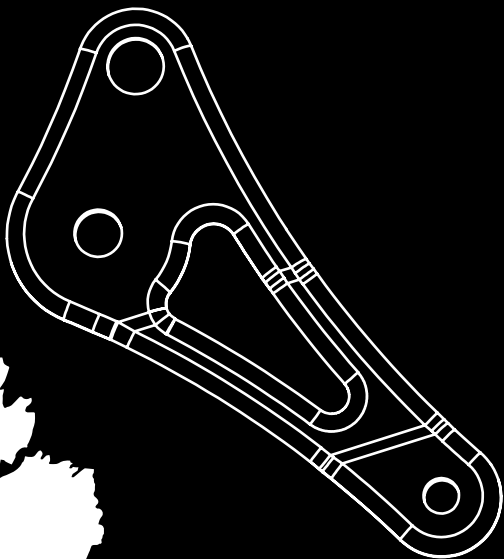

RP280 Rope Wrench & Tethers (NOT FOR PRIMARY LIFE SUPPORT)



I|S|C

ARB GEAR

climb. work. rescue.



RP280 Rope Wrench & Tethers



SPECIAL ROPE WRENCH & TETHER WARNINGS

Never use as life support. Failure to use proper life support will lead to serious injury or death.

For use only by Arborists who are experienced in SRT. Using the Rope Wrench without proper training and experience with SRT can lead to serious injury or death.

Practice using device "low and slow" before using at heights.

Improper orientation of installation will cause the device not to function.

Read and follow all of these instructions before using the device.

Serial number.:

Date of manufacture:

Nomenclature & Markings	4
Intent & Purpose	7
Basic Operation	7
Equipment Checklist	8
Equipment Requirements	9
Standard Set-up Instructions	12
Rope Wrench Set-up Instructions	14
Climbing using the Rope Wrench System	16
Basic Operation of the Rope Wrench	16
Ascending	16
Descending	16
Limb-Walking with the Rope Wrench	17
Equipment Maintenance & Inspections	18
Dynamic Inspections	20
Post-climb Inspections	20
General Maintenance	21
SRT and DdRT	21
Product Record	22

Nomenclature

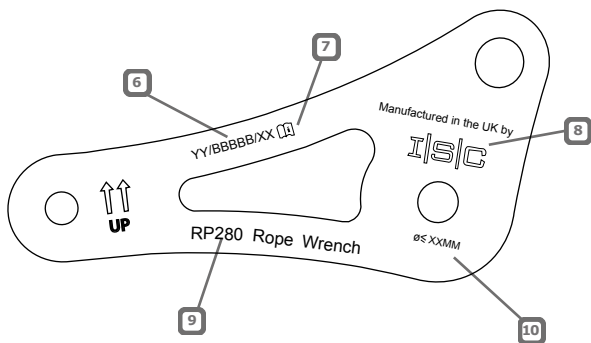
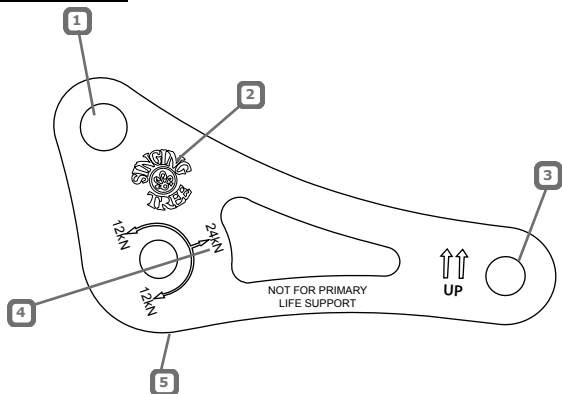

- [1] Slic Pin
- [2] Product Logo
- [3] Tether Attachment Point
- [4] MBS - Minimum Breaking Strength
- [5] Wheel

- [6] Serial Number
- [7] Pictoram Informing User to Read Instructions
- [8] Manufacturers Identification
- [9] Part Number
- [10] RP280 11-13mm (7/16- 1/2");
RP283 Optimised for 13mm (1/2") only

RT270B1 Single Leg Tether

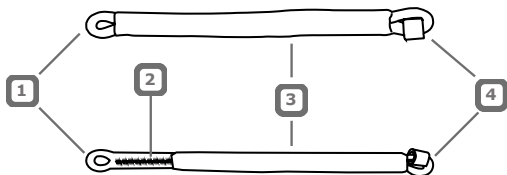

RT270C1 Double Leg Tether

- [1] Karabiner attachment eye
- [2] Stitching
- [3] Shrink tube
- [4] Rubber Grommet

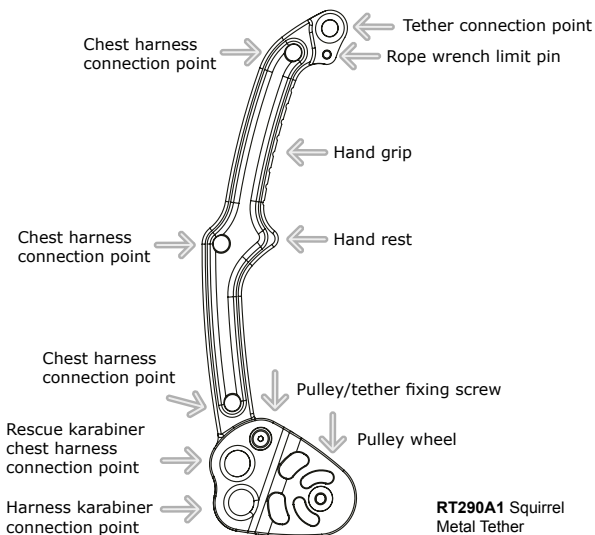

Tether Markings

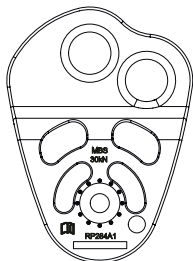

RP284A

climb. work. rescue.

MMYY

I|S|C

Serial #
XXXX

Solutions in Metal

RT270XX

Inspect Daily Use As Designed Store Properly

MBS: 5,400lbs complies with ANSI Z133.3

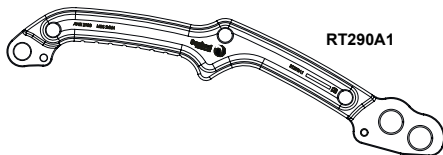

RT290A1

Tether Combinations

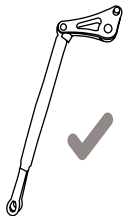

Wrench + RT270C1



Wrench + RT2270B1

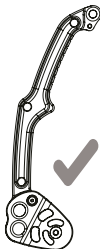

Wrench + RT290A1

Wrench Part Codes:
RP280 11-13mm,
RP283 13mm only

Intent and Purpose

The Rope Wrench is meant to be used by Arborists servicing, accessing, or maintaining trees in conjunction with a Single Rope Technique (SRT) configuration. The Rope Wrench is a friction control device that allows a climber to ascend and descend a single rope without changing equipment. When used as part of a secure hitch based climbing system, it allows the climber to smoothly control the rate of descent by adding friction to the climbing system.

The Rope Wrench is NOT:

- a life support device. It is, however, a load-bearing device that may bear more than 50% of the climber's weight during the climb;
- for use without a life supporting friction hitch or similar device that will immediately stop descent in an emergency situation;
- for use by persons novice to SRT techniques;
- an SRT training device



Basic Operation

The Rope Wrench has two gears, neutral and engaged, as shown below.

Neutral Gear

(Fig 1a) The climbing rope can pass freely through the Rope Wrench.

Engaged Gear

(Fig 1b) Due to downward loading on the tether attachment point, the climbing rope is bent into an S shape by the Wheel and the Slic Pin. The climbing rope may still pass through the Rope Wrench, but the Slic Pin and Wheel apply friction that slows it down.

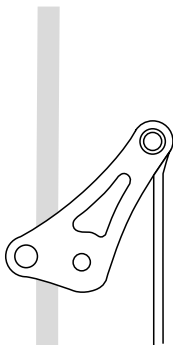

Fig 1a
Neutral Gear

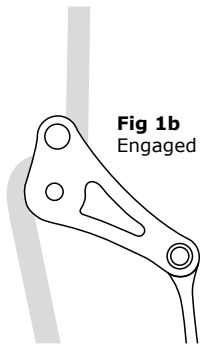

Fig 1b
Engaged Gear

Equipment Checklist

(Equipment needed to safely climb using the Rope Wrench System)

- Rope Wrench
- Climbing Rope
- Friction Hitch
- Tether
- Karabiner
- Harness
- Helmet, Boots and Safety Glasses
- Back-up descent device such as a karabiner for a munter hitch

Optional Equipment

- Slack-Tending Pulley
- Other Personal Protective Equipment (PPE)
- Ascender(s)

Fig 2
Fully Assembled Rope Wrench System

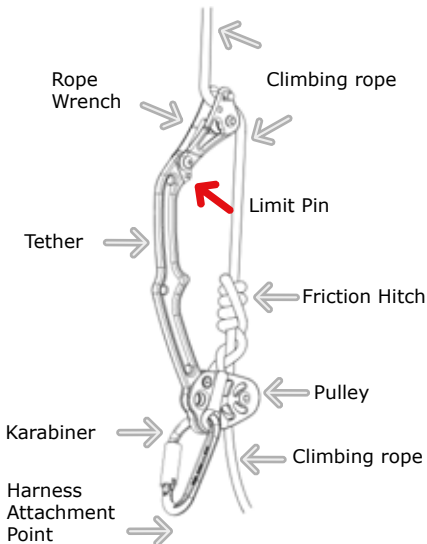

PJ429 Squirrel
Rope Wrench

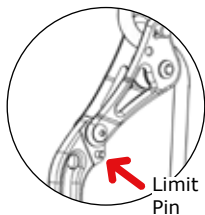

The limit pin on the tether on the Rope Wrench prevents Wrench from slipping in to neutral position.

Note: Attach harness to end of karabiner. If desired, Ascenders could attach to the climbing rope above or below the system.

Equipment Requirements

Rope Wrench

Always use the original Rope Wrench manufactured by ISC. Do not attempt to use a "home-made" Rope Wrench.

Climbing Rope

It is recommended that 16 or 24-strand rope, made of Nylon, Polyester, Polypropylene or Kernmantle, is used. Ropes should be of a type that is approved for use in Arboriculture. Ultrastatic climbing rope is NOT recommended. Rope should have just enough 'give' or 'bounce', to be comfortable. Always use the correct diameter rope: RP280 11-13mm (7/16 -1/2"), RP283 13mm (1/2") rope only.

Friction Hitch

It is advised that a heat resistant rope of a different material than of the climbing rope be used for the friction hitch.

Climbers should refer to the STANDARDS section of this document for details on suitable Friction Hitches

(Note 1) The above recommendations for the selection of ropes are general guidelines only. There are many factors that go into selecting suitable ropes for climbing. A professional Arborist should carefully consider all the factors present before making a decision regarding the ropes to be used.

(Note 2) It is recommended that each rope used in the Rope Wrench system be a different colour or pattern for clarity of distinction.

Tether

The Rope Wrench must be used in conjunction with a stiff tether, which is specifically designed for use with the Rope Wrench. Do not use tethers which are made from brittle materials, such as Acrylic or wood. Do not use home-made tethers. We recommend the use of ISC Single, Twin-leg or Squirrel Aluminium Tethers.

A suitable tether allows 8cm (3") of room between the hitch and the Rope Wrench in an engaged and fully equalised set up

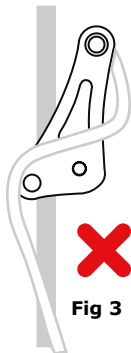

Fig 3

Fig 3

DANGER: FREE FALL HAZARD

Do not use a loose or supple tether with the Rope Wrench. It may become entangled in the Rope Wrench and cause it to be locked in neutral and release the grip of the friction hitch. This will lead to free fall resulting in serious injuries or death.

Dangerous result of using a loose or supple tether: Rope Wrench is stuck in neutral position and could release the grip of the friction hitch below it.

Karabiner

The karabiner selected must be designed for use in arboriculture;
be self-closing;
be self-locking;
take three consecutive and deliberate motions to unlock (triple locking).

Be large enough to ensure that when configured, no loading or interference with the gate occurs.

Be secured such that no loading or interference with the gate will occur.

(The ISC KH204SS HMS Karabiner is an example of an acceptable Karabiner).

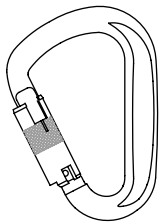

Harness

The harness selected for use with the Rope Wrench system must be adjusted to best fit the climber's body. Suspended work positioning harnesses are recommended for use with the Rope Wrench system. Harnesses with a chest attachment point may be used with the Rope Wrench and should be attached to the Tether Attachment Point or to the tether itself. A chest attachment point should not be load bearing and is only meant to keep the system upright and to keep the slack out of the system. (See section titled Setting Up the Rope Wrench System).

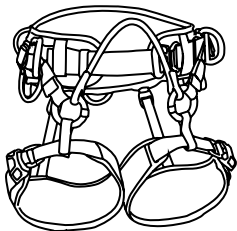

Helmet, Boots and glasses

It is the responsibility of the climber to select a suitable tether.

It is always recommended that the climber wear a helmet, boots, and safety glasses that have been commercially manufactured for arboriculture.

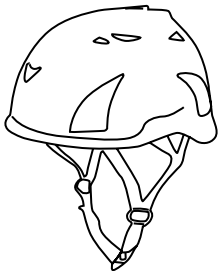

Optional Equipment Recommendations

Other PPE

Each climb will have its own unique set of obstacles and hazards that should be well understood before climbing begins. Use of other PPE such as ear, face, hand, leg and respiratory protection will depend on the level of exposure of the climber to these hazards.

Slack-Tending Pulley

When using Textile-based Tethers (such as RT270B1 Single, or RT270C2 Twin-leg Tether), a pulley is not essential, but is recommended in order to assist in keeping slack out of the system and for moving (minding) the friction hitch up the rope, during ascent. For this purpose, use a pulley which is specifically designed for climbing systems (such as the RP282 PHLOTICH Pulley).

The Squirrel Tether should always be used with the 'Squirrel Pulley' which is supplied as part of the Squirrel Tether Kit.

Ascenders

Mechanical ascent devices such as foot or hand ascenders are compatible with the Rope Wrench. Any time more gear is added to any rope system it increases the complexity and likelihood of disorder and entanglement. Extra care must be taken to maintain a clean and tidy system when using ascenders as becoming entangled in gear can lead to catastrophe especially when panicked.

Back-up Descent Device

During a particularly long descent, the life of the friction hitch can be prolonged by incorporating the use of a back-up descent device. A munter hitch or a figure eight may be used above or below the friction hitch in place of or in conjunction with the Rope Wrench. A back-up descent device can also be used if the Rope Wrench becomes incapacitated during the course of the climb. (e.g., if the climber loses the Slic Pin).



WARNING: USE OF A FRICTION HITCH



Always remember that the Rope Wrench is not a life support device and even a system using ascenders in conjunction with the Rope Wrench requires a properly tied and functioning friction hitch. Failure to do so can result in serious injuries or death.

Standard Set-up Instructions

NOTICE: REGARDING SUBSTITUTIONS

The following set-up instructions are based on the equipment recommended in the previous section. Substitutes to any of the equipment or methods described herein are made at the sole risk of the climber. Make sure the function and limitations of any substitutions are well understood before deviating from these instructions.

Step 1. Choosing a Time And Place

Every climbing location has an unlimited number of potential obstacles and hazards. Even with a perfectly rigged system and all the proper PPE, some conditions can still pose a threat to a climber's safety. Consider the following when choosing a time and location for climbing.

Environmental Conditions

- Rain or moisture can lead to slipping.
- Wind can affect stability and send debris toward the climber.
- Lightning can often strike trees.
- Humidity can affect the function of equipment, particularly the friction hitch.
- Temperature can affect the function of equipment, and affect the performance of the climber

Tree-Specific Hazards

- Insect and animal habitations that can become agitated.
- Dead, rotten, or weakened branches can break especially when used for anchoring.
- Nearby power lines.
- Anything sharp, such as nearby fences or encroaching structures

Step 2. Anchoring

1. Tie a weighted object to one end of the climbing rope.
2. Throw the weighted object over a limb or crotch that will support several times the weight of the climber.
3. Tie the climbing rope to the tree using a trunk- secured basal approach or a limb-secured canopy approach.

Note: The climber is responsible for having sufficient knowledge and experience with tying secure anchors. If there is any uncertainty in tying an anchor, consult with a professional Arborist.



DANGER: FREE FALL HAZARD

Failure to properly anchor any rope climbing system will lead to free fall resulting in serious injuries or death.



WARNING: USE EXCESSIVE ROPE

Leave excessive rope at the working end so that the climber can always reach the ground and will not unintentionally come off the rope. This is particularly important if the climber intends to move from branch to branch within the tree. Failure to supply sufficient rope can result in serious injuries or death.

**WARNING: USE PROPER HITCH**

The friction hitch is a climber's ultimate life support and failure to properly tie and operate a friction hitch can lead to serious injury or death.

Step 3. Tie Friction Hitch

Tie a secure friction hitch to the climbing rope. Examples of appropriate friction hitch styles include Valdotaín, Michoacán, Distel, Schwabisch, Cooper's, XT, and Knut. Mechanical friction hitches may also be acceptable (check with the manufacturer that the mechanical device is rated for SRT.) The friction hitch chosen must be well understood before use.

Note: It is imperative that the climber knows how to properly tie a friction hitch. There are many variables to be considered when tying a friction hitch, such as temperature, humidity, level of expertise, desired ascent and descent speeds, etc. There is no substitute for experience and hands-on training – consult with a professional arborist if you are not properly experienced or trained.

Step 4. Attach Elements to Karabiner

Attach the ends of the tied friction hitch and one end of the tether to the karabiner. If using a pulley, slide it onto the rope and attach it to the karabiner as well. Attach all elements so as to maintain symmetry on the karabiner, e.g., attach the ends of the friction hitch on either side of the tether.

Test:

Apply as much downward force on the karabiner as possible to ensure the friction hitch is gripping the rope properly. This should be done multiple times. Ensure that the friction hitch catches when the climbing rope is both weighted and unweighted before the Rope Wrench is installed on the line.

Step 5. Attach System to Harness

Attach the end of the karabiner to your harness at the designated attachment point. If the harness has a chest attachment point, attach it to the Tether Attachment Point or to the tether itself.

Step 6. Bounce Test

1. Slide the friction hitch and Rope Wrench up the climbing rope as far as possible.
2. Lean back or crouch down so that the friction hitch grips the rope. Proceed to the next step only if this is successful.
3. Take a small jump and swing the legs forward, such that the entire body weight is put onto the system and the climber bounces on the rope.
4. Look and listen for cracking or creaking from the supporting branches and trunk. Do not climb on the system if cracking or creaking is observed.
5. Be sure there is no excessive give in the branches.
6. Perform all relevant inspections listed in the section titled "Pre-Climb inspections".

This test ensures the system will maintain its integrity should a fall occur.

Rope Wrench Set-Up Instructions

Step 1. (option 1) Attaching a Textile Tether to the Rope Wrench

1. Unscrew and remove the Tether Attachment Point bolt.
2. Place the free end of the tether between the Side Plates at the Tether Attachment Point.
3. It is recommended that a reversible thread-locking fluid be applied to the bolt to prevent loosening.
4. Reinsert the bolt.
5. Make sure the bolt is screwed in all the way.

Step 1. (option 2) Attaching the Squirrel (Aluminium) Tether to the Rope Wrench

1. Unscrew and remove the Tether Attachment Point bolt.
2. Select the correct fittings for the type of Rope Wrench that you are using: For Rope wrench **RP280** (11mm) **DO NOT USE** the washers provided, for rope wrench **RP283** (13mm) **USE** the washers (x 2 provided) - see diagrams below.

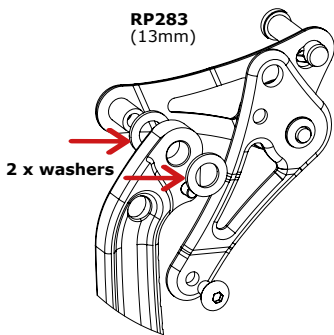
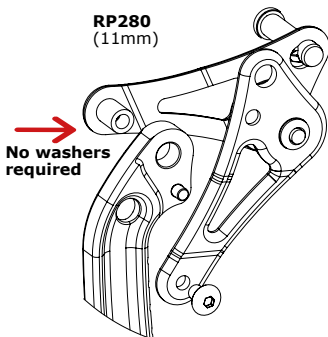

3. Press fit the selected sleeve(s) into the tether attachment point aperture - see diagrams below.
4. Place the free end of the tether between the Side Plates at the Tether Attachment Point.
It is recommended that a reversible thread-locking fluid be applied to the bolt to prevent loosening.
5. Reinsert the bolt.
6. Make sure the bolt is screwed in all the way.

Do not

- repeatedly remove and attach tethers
- force the bolt into the socket
- use the device if the bolt will not fully screw in
- use the device if the bolt is loose

CAUTION: TIGHTEN TETHER BOLT

The bolt at the Tether Attachment Point may come unscrewed during climbing if not properly tightened. This will cause the tether to detach and render the Rope Wrench useless.

Step 2. Attaching the Rope Wrench to the Climbing Rope

1. Press the spring-loaded tab on the Slic Pin inward and pull the Slic Pin out of the first side plate. There is a small recess on the inside of the other side plate that seats the spring-loaded tab, allowing the climbing rope to be inserted without removing the tab completely.
2. Place the climbing rope along the Wheel.
3. Push the Slic Pin back in such that the climbing rope is secured between the Slic Pin and the Wheel.

Fig 5.

Do not install the Rope Wrench upside-down (see below for proper installation orientation). It will not function at all if upside-down and may interfere with the friction hitch.

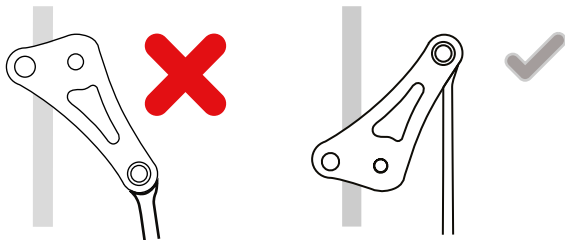
Fig 5**CAUTION: SECURE SLIC PIN**

The Slic Pin relies on the actuation of a small spring to become secured. Before use, ensure that the Slic Pin is fully inserted, constrained, and uninhibited by any rope fibres, and that the metal tab clicks outward. Failure to do so will cause the Rope Wrench to come off of the climbing rope and render the Rope Wrench useless.

**WARNING: INSTALLATION ORIENTATION**

Do not install the Rope Wrench upside down. Failure to do so could interfere with the function of the friction hitch and can lead to serious injury or death.

Note: When installed correctly and pulled down, the Rope Wrench should bend the climbing rope into an S-shape.

Step 3. Repeat Bounce Test

With the Rope Wrench installed, repeat the 'Bounce Test'(as described in Step 6, under 'Standard Set-up Instructions').

Climbing using the Rope Wrench System



NOTICE: PRACTICE "LOW AND SLOW"

Practice all of the instructions in this section "low and slow" before ever attempting anything at height, regardless of experience or skill level.

Ascending



WARNING: DO NOT USE AS ASCENDER

Do not attempt to hang on the Rope Wrench as you would an ascender as this may inadvertently release the friction hitch and can lead to serious injury or death.

The Rope Wrench is NOT an ascender and plays no part in ascending. It must, however, be pulled up along with the rest of the system as the climber ascends, in order to keep the system clean and tidy. This can be facilitated by attaching a harness with a chest attachment point to the Tether Attachment Point of the Rope Wrench or to the tether itself. This will help keep slack out of the system as the climber ascends. Ascend using any desired SRT method. Hand ascenders, foot ascenders, foot loops, and the footlocking method are all acceptable means of engaging the rope. The sit-stand method helps keep slack out of the system.



WARNING: UNDERSTAND SRT

The Rope Wrench must only be used by arborists who have received training and have practical experience with climbing using the Single Rope Technique (SRT). Using the Rope Wrench without proper training and experience with SRT can lead to serious injury or death.

Descending



DANGER: NOT FOR LIFE SUPPORT

The Rope Wrench is designed to act as a friction control device. It is not a life support device. The climber must always rely on the friction hitch as primary life support. If the friction hitch does not engage, it cannot be expected that the Rope Wrench will slow the climber's fall. Using the Rope Wrench as life support will lead to serious injury or death.

Before Descending.

Ensure that the Rope Wrench has begun to engage (refer to Figure 1b.) To do this, move the Rope Wrench as far up the climbing rope as possible, and while holding it there, gently release the grip of the friction hitch so that the body weight can be partially shifted from the climbing rope to the tether, which should then begin to engage the Rope Wrench.

Descent.

To descend, simply pull down gently on the top of the friction hitch to release its grip on the climbing rope. The friction from the engaged Rope Wrench and partially engaged friction hitch will allow the climber to descend at a smooth, controlled rate. At no point during descent does the Rope Wrench need to be touched.

**DANGER: RAPID DESCENT HAZARD**

Do not use the Rope Wrench to release the grip of the friction hitch. This will cause very rapid descent resulting in serious injury or death.

CAUTION: DO NOT DESCEND TOO QUICKLY

Although the Rope Wrench is designed to act as a heat sink during descent, the climber should not descend too quickly, as doing so can still damage the friction hitch.

Halting Descent. To stop descending, simply let go of the friction hitch.

Limb Walking with the Rope Wrench

Your rope must be tied to a secure anchor point. From this Tie in Point (TIP), the rope may pass through redirects as the climber works the tree. Unlike DdRT, using the Rope Wrench allows consistent friction regardless of the number of redirects the climber uses. Redirects help the climber to prevent dangerous swings or bad rope angles. It is crucial that the climber never climb above his last redirect or be exposed to an uncontrolled swing. Dynamic falls and uncontrolled swings can cause serious injury or death.

It is important to not allow slack in the system at any time and always be aware of tripping hazards and stubs that can impale during the course of a fall or swing.

To limit the exposure to dangerous swings, take advantage of natural redirects in the tree. Select redirects with caution and care. Being able to judge the health and strength of trees as well as understanding the physics of fundamental tree rigging are imperative to being a safe climber.

Understand that forces can be multiplied on redirects depending on the angle of the rope. Understand that a redirect that is strong in one direction may be weak when pulled from another angle. Constantly inspect the tree for spots of decay and test the redirect before trusting you full weight to it. TREES ARE NOT RATED. Only good judgment can prevent a climber from over stressing a limb or tree.

If the climber clips the tail of their climbing line through a pulley fixed to the working part of the line, the system can be converted from a 1:1 climbing system to a 3:1 climbing system.

MISUSE: Do not apply side loads to the tether (do not load across branches or tree trunks etc.)

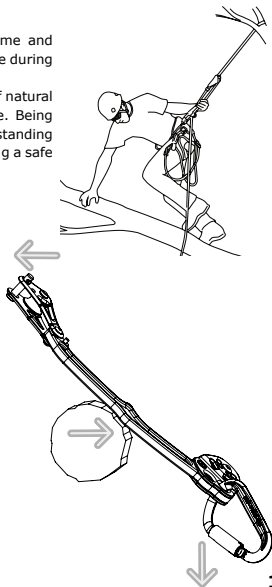

Regarding Aerial Rescue

The Rope Wrench may be used as a tool both by rescuers as well as by victims of accidents at height. When used by a rescuer: The rope wrench provides additional friction to the system and allows a friction hitch to work. It is not designed for heavy loads or high speeds. If the rescuer is performing a pickoff while on a single line then additional friction besides a rope wrench should be employed. If the Rescuer is using double rope technique, then a rope wrench can be added to the system to provide additional friction to the system.

*If the Victim is using a wrench, the cause of the accident must first be understood. Depending on the scenario, different options are available. If the climber has been using a basal anchor, he may be lowered to the ground by using the climber's rope. The lowering system should be well thought out and secure. Use backups so that if the belayer loses their grip on their rope there will be a backup.

It may not be possible to lower the climber using a basal anchor so he must be lowered using Aerial Rescue techniques. Depending on the incident, the climber's system may not function. If there has been a large fall, the hitch may be tight to the line and the hitch cord may even be damaged by the fall. In this case, lifting the injured climber and transferring him to an alternate system may be the best course. If through inspection, the climber's system is still intact, then the injured climber may be lowered using his/her own system.

Equipment Maintenance and Inspections

Pre - Climb Inspection

Before each and every use of the Rope Wrench System, all components should be inspected for damage, wear, and compatibility with the present situation. Never use any piece of equipment that does not pass all inspections listed below.

Standard Equipment Inspections

Ropes & Ropes Accessories

Consult the Rope Manufacturers instructions.

Each rope (particularly the climbing rope, friction hitch, and tether) should be inspected for anything that makes the rope appear non-uniform, including:

- Carry out a visual and tactile check.
- Check out the condition of the sheath over the whole length of the rope looking for signs of cuts, wear, contamination, furring, sheath slippage, burns bulges, flat spots, stiffness and dirt/grit etc.
- Run the rope through hands, Make a loop, creating a constant curve in the rope. The rope should maintain a regular curve along its entire length.
- Check the condition of the protective parts covering stitches or splices. For stitched terminations slide off the protective sleeve and check that the stitching is not cut, torn, worn or stretched.
- Where appropriate untie knots to check ends of rope for wear and distortion.
- Be sure all ropes were stored in a clean, dry, non-corrosive environment (or acceptable environment per the manufacturer's specifications). Leaving a rope in adverse environment for longer than the time required to perform the necessary tree work could cause it to be invisibly weakened and should not be used.

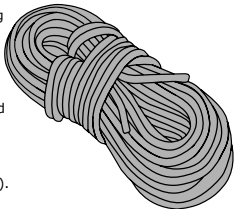

Karabiners, Pulleys, and Ascenders.

Each of these devices will be slightly different depending on the choices of the climber. As such, they will all have their own set of inspections to be made. Follow these general guidelines

1. Always begin by consulting the instructions or owner's manual for that particular device.
2. Operate the device several times to verify proper operation (for example, for the Karabiner, unlock, open, and let it close).
3. Check for burrs or sharp edges.

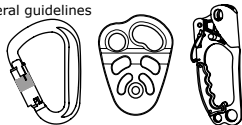

Harness.

Each harness will be different depending on the choice of the climber. Consult the harness's instructions or owner's manual for directions regarding pre-climb inspections.

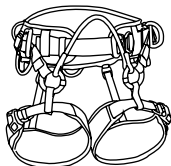

Rope Wrench Specific Inspections

1. Inspect the **entire device** for burrs or sharp edges that may have developed through use or during storage.
2. Visually check the **Slic Pin** to ensure the spring-loaded tab is sticking out and keeping the Slic Pin from moving.
3. Attempt to pull the **Slic Pin** out to ensure the spring-loaded tab will not allow it to come out.
4. Ensure the wear on the **Slic Pin** is not excessive. The Slic Pin is prone to wear due to friction between itself and the climbing rope.
5. Check the **Side Plates** for damage. The Side Plates are designed to be slightly bent but symmetrical.
6. Rotate the **Wheel** to ensure it moves freely and is not obstructed by rope fibers or anything else.
7. Ensure the **Tether Attachment Point** bolt is tight and that there are no gaps between the bolt heads and the outsides of the Side Plates.

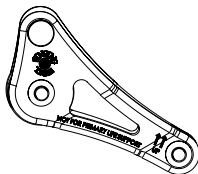

Specific Inspections for RT290 Squirrel (Aluminium) Tether & Squirrel Pulley.

1. Inspect the entire device for burrs or sharp edges that may have developed through use or during storage.
2. Check the tether for distortion/twisting/bending see diagram (right).

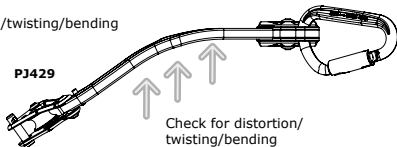

3. Check the pulley side plates for damage. The side plates are designed to be a formed 'zig zag' shape. The side plates **are** symmetrical.
4. Rotate the pulley sheave (wheel) to ensure that it moves freely and is not obstructed by rope fibres or debris, etc.
5. Ensure that the pulley and tether attachment bolts are tight and that there are no gaps between the bolt head/ washer and the outsides of the side plates.

Dynamic Inspections

Throughout the course of a climb, the climber, as an expert, must constantly monitor the system and surroundings for changes that may present a hazard. For example, a friction hitch may begin to loosen and respond differently after a very long ascent. Memorize the **"TREES"** method described below for maintaining safety while climbing.

- [T]**ight friction hitch. Always be sure the friction hitch is tight and will engage in the event of a fall at all times. Even if a friction hitch was very tight when first tied, it can become loose over the course of a climb.
- [R]**ope must be securely attached to a solid anchor point and remain free of damage or wear at any point it is repeatedly contacting anything (branches, pulleys, rope wrench, etc.)
- [E]**xcess rope at the end of the climbing rope. This is **DESIRED** so that the climber does not come off the rope.
- [E]**xcessive slack in the system. This is **NOT DESIRED** and should be avoided.
- [S]**harp objects. Burrs and sharp edges in the system or in the tree can damage the rope and must be avoided.
- [TREES]** Inspect all parts of the tree supporting any part of the body weight to ensure they are not cracking, creaking, or overly bent.

Post Climb Inspections

The inspections performed after a climb should be the same as the inspections performed pre-climb. Particular attention should be given to the post-climb inspections when any of the following occurred during a climb:

1. A fall from height. If the reason for the fall is due to failure of any of the equipment, discard it immediately.
2. Any intermittent fall. This will likely cause damage to the rope wrench, friction hitch, and climbing rope.
3. Very long climbs, especially those involving many descents and ascents.

Tether Inspection

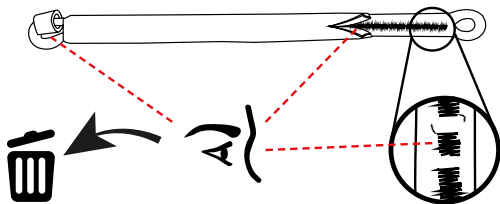

Inspect tether for damage to Shrink Tube, Stitching and attachment eyes.
The Rope Wrench should also be inspected for damage and function

General Maintenance

Never leave the Rope Wrench or any other components out in the elements. Even if exposure to the elements does not damage the equipment, it can still alter the functionality.

The Rope Wrench should be cleaned after each use with a mild detergent and allowed to dry naturally.

The moving parts of the Rope Wrench may be oiled if desired. Wipe away any excess oil before use. Ensure the oil type will not degrade any rope used in the Rope Wrench System.



SRT and DdRT

Single Rope Technique (SRT) and Doubled Rope Techniques (DdRT) are somewhat subjective terms that can mean slightly different things to different people and different organizations. Other names for Single Rope Technique are Static Rope Technique or Dynamic Rope Technique. SRT as referenced in these instructions simply refers to any means or methods of ascending and descending a tree on a single leg of rope that does not move with the climber.

For more information on the meanings of these terms, refer to the following resources:

International Society of Arboriculture: www.isa-arbor.com

Tree Care Industry Association: www.tcia.org

On Rope, by Bruce Smith and Allen Padgett (ISBN: 978-1-879961-05-0)

Best Practices for SRT in Arboriculture, by Donald Coffey and Tchukki Andersen (TCIA publication)

Single Rope Technique, by Joe Harris (The Victorian Tree Industry Association)

<http://vtio.org.au/Content/wp-content/uploads/2010/07/Single-Rope-Technique-i.pdf>

Product Record

1.Item

4.Purchased from

7.Date of first use

10.Conform

2.Date of first use

5.Purchased date

8.Inspection date

11.Comments

3.Year of manufacture

6.Name of Manufacturer,

9.Reason

12.Signature

1					
2					3
4					5
6					7
8	9	10		11	12
		✓	✗		
		✓	✗		
		✓	✗		
		✓	✗		
		✓	✗		
		✓	✗		
		✓	✗		
		✓	✗		
		✓	✗		
		✓	✗		
		✓	✗		
		✓	✗		
		✓	✗		
		✓	✗		
		✓	✗		

I|S|C

International Safety Components Ltd.
Unit 1, Plot 2
Llandygai Industrial Estate
Bangor
Gwynedd
LL57 4YH
United Kingdom

T> +44 (0) 1248 363 125

sales@iscwales.com
www.iscwales.com

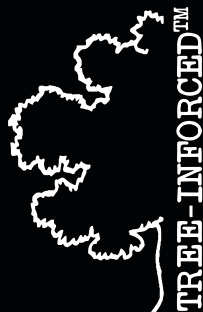

climb. work. rescue.