

Kumo Sofa with Armrests

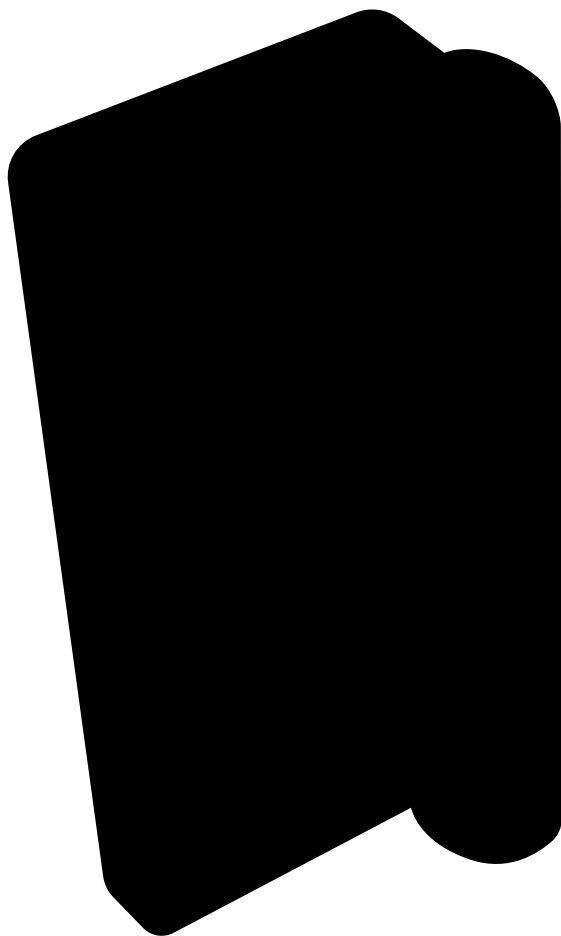

Assembly Instruction

Kumo Sofa

Most modular

The Kumo Sofa system is built around an innovative metal frame onto which individual cushion components are added. This intelligent design from Anderssen & Voll makes Kumo especially convenient to live with—readily reconfigurable whenever and however you wish. Kumo is also efficient and responsible to ship thanks to the same quality: it dismantles easily. Like its namesake—Kumo means “cloud” in Japanese—this sofa is light and soft as well as clever, with generous, foam-filled cushions covered in a luxurious, highly textured woolen fabric as a final flourish.

Please note: The exact number of the parts in your package vary with each Kumo configuration.

Parts: Building the Kumo 3-seater Sofa with Armrests



Knob

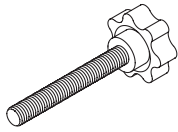

Screw

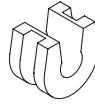

Plastic fitting

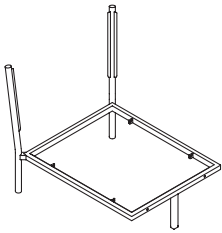

End frame

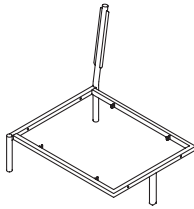

Extension frame

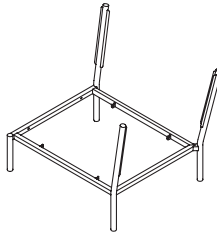

Start frame



Side view



Top view

Armrest



Side view



Top view

Side backrest

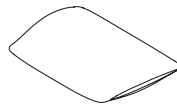

Side view



Top view

Straight backrest

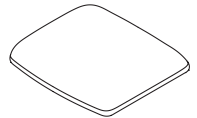

Side view

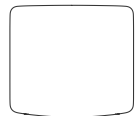

Top view

Seat

Please note: The Kumo Sofa 3-Seater consists of a Kumo Sofa 2-Seater + extension module. The Kumo Sofa 4-Seater consists of a Kumo Sofa 2-Seater + two extension modules.

Step 1

Starting with the start frame, the right hand side of the final sofa, click in all the plastic fittings with the help of a screw driver, in case they're not in place.

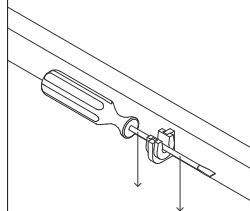
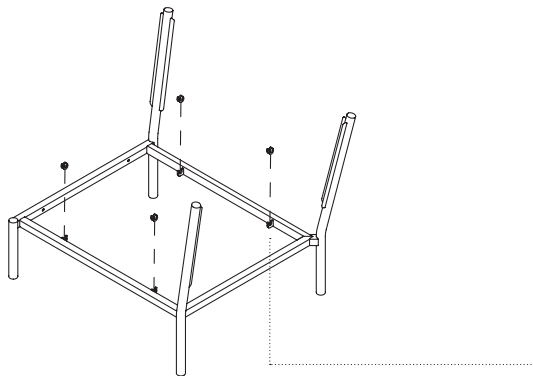

Step 2

Attach the extension frame to the start frame by using the screws provided as seen on the picture below.

Repeat the same process with the last frame, the end frame, until your sofa frame looks ready assembled.

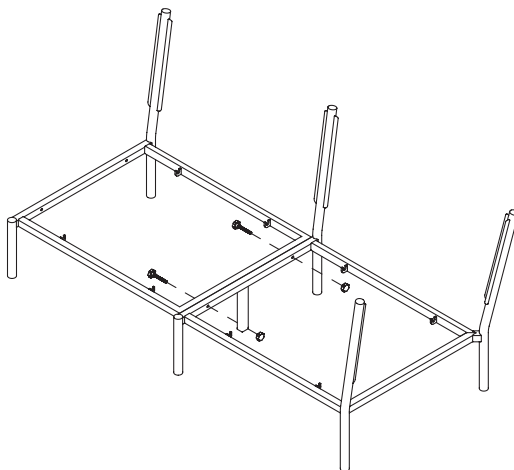

Step 3

Your Kumo 3-seater Sofa with Armrests should now look like this from the top.

Next, get familiar with the direction of the seat cushion before continuing with step 4.

Back

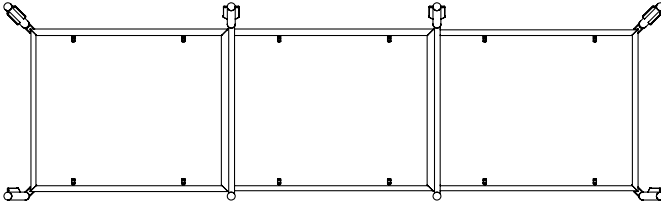

Front

Back

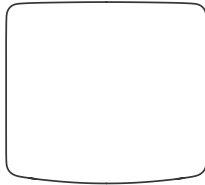

Front

Step 4

Next, click the seat cushions into the frame. Start from the right to the left side.

When you hear a click sound, the cushions sit tightly in the frame. Use your knee for more force.

Double check, that you have clicked the seats in correctly and facing the right way.

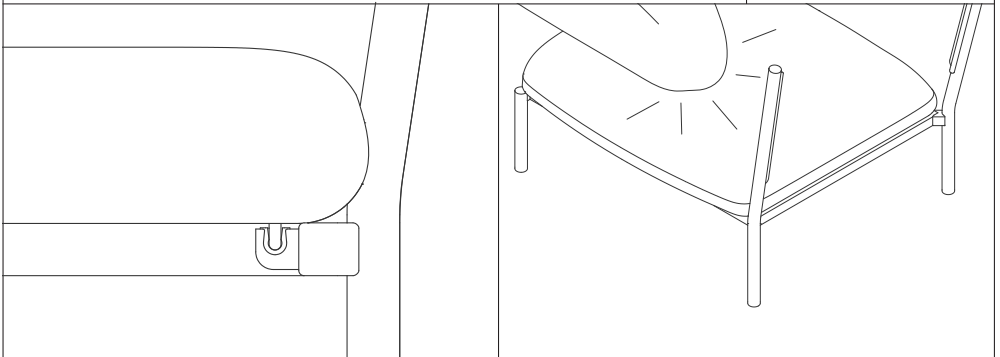
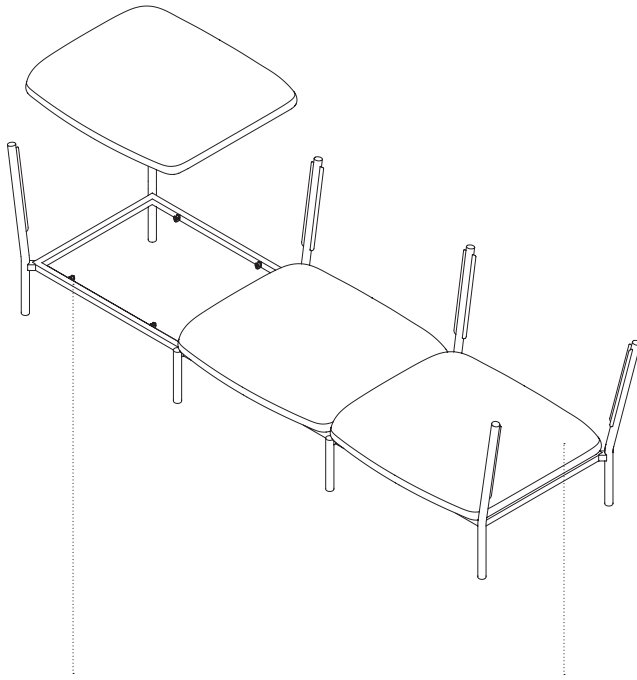

Step 5

Next, slide the armrest cushions into the outside slots of the frame.

Make sure the cushions are placed correctly, as below.

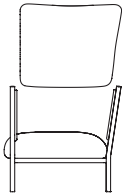
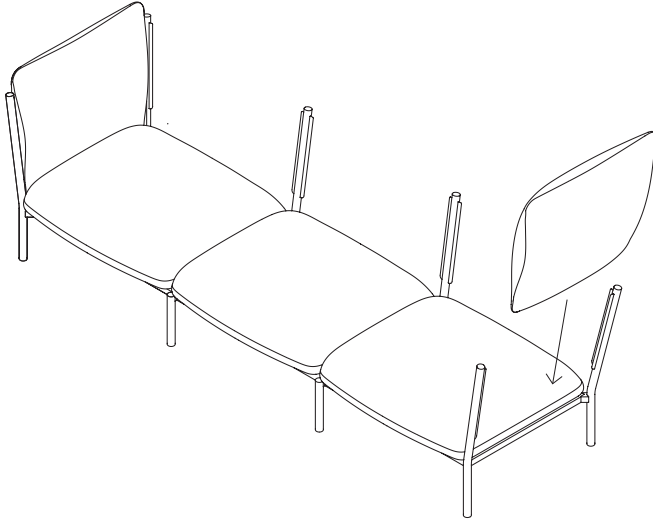

Correct



Incorrect

Step 6

Start from left to right for easiest assembly. Slide in the first side backrest cushion. Make sure the cushions are placed correctly, as below.

Next, slide in the straight backrest cushion.

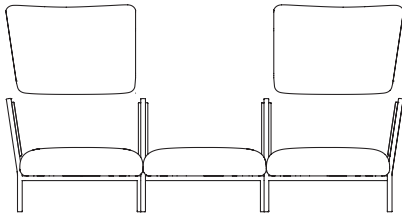
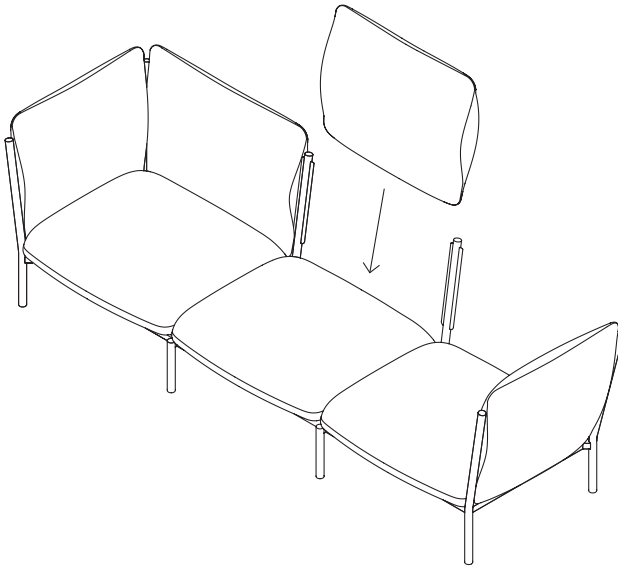

Correct

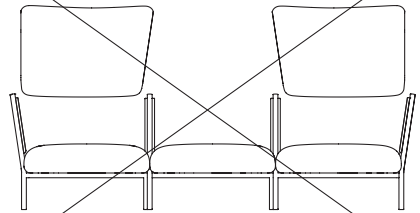

Incorrect

Step 7

Lastly, slide in the right outer side backrest cushion.

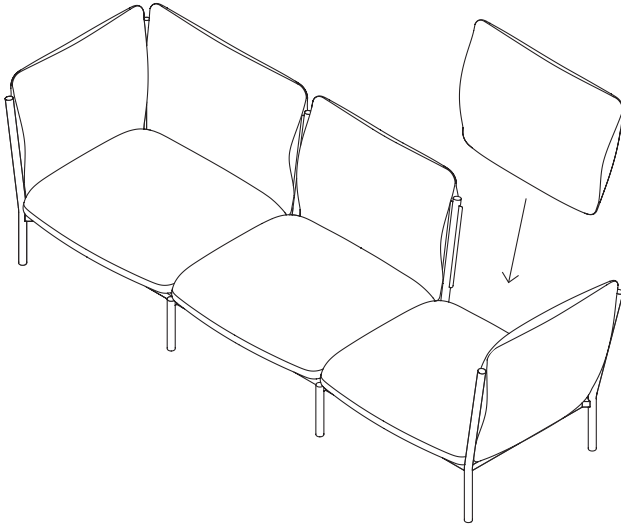

Step 8

Your Kumo 3-seater Sofa with Armrests is now ready assembled!

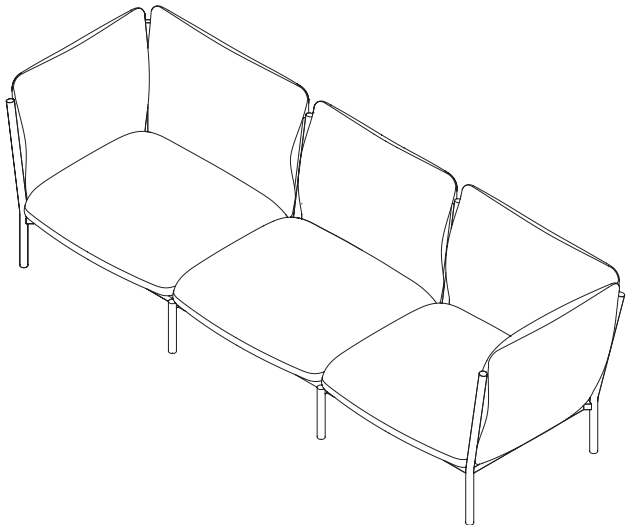

Notes

Should you have any problems assembling your product, contact us at info@hem.com. We're always happy to help!

Hem