

VIEW MORE DETAILS 

FORCE8™ Industrial

Installation and User Guide

Cellular Signal Booster for voice, 4G LTE and 5G
data with Built-In Sentry Monitoring

Contact Us:

>> 1-855-846-2654 >> <https://www.signalbooster.com/pages/contact-us> >> order@signalbooster.com

Available Monday – Friday, 7am – 5pm PST

Contents

CONTENTS

Chapter 1: Introduction	2
1.1 Package Contents	2
1.2 Features & Benefits	2
1.3 Additional Items Needed	2
1.4 How Cellular Signal Boosters Work	2
Chapter 2: Safety	4
2.1 Safety Warnings	4
Chapter 3: Planning The Installation	5
3.1 Installation Overview	5
3.2 Exterior Antenna	6
3.3 Interior Antennas	7
3.4 Antenna Separation	8
3.5 Calculating Signal Strength	9
3.6 Booster Location	11
3.7 Accessories	11
3.8 Need Help?	11
Chapter 4: Installation	12
4.1 Soft Installation	12
4.2 Exterior Antenna	12
4.3 Interior Antennas	13
4.4 Mounting the BDA	14
Chapter 5: Configuration & Testing	15
5.1 Powering on the BDA	15
5.2 DIP Switch Configuration	15
5.3. DIP Switch organization	16
5.4 LED Conditions	17
5.5 Testing & Troubleshooting	18
Chapter 6: Sentry Configuration	19
6.1 Software Installation	19
6.2 Hardware Installation	19
6.3 User Registration	20
6.4 Device Registration	21
6.5 Device Configuration	21
6.6 Over Power Alert	24
Chapter 7: Specifications	26
Chapter 8: Warranty	28
8.1 Warranty Periods	28
8.2 Three-Year Product Warranty	28
8.3 Limitations of Warranty, Damages and Liability	29
8.4 Compliance	30

CHAPTER 1: INTRODUCTION

Introducing SureCall's Force8 Industrial Booster. Please read this entire manual before proceeding.

1.1 Package Contents

Your booster box contains the following items:

- (1) Force8 Industrial booster with built-in Sentry monitoring system
- (1) Power supply
- (1) USB cable to set up Sentry software

1.2 Features & Benefits

The booster offers the following features and benefits:

- First 5G signal booster that improves 5G service inside buildings for the T-Mobile (600 MHz) bands
- Improves 3G and 4G LTE voice, text, and data signals for every US cell carrier
- Extends cellular signals in areas with poor coverage due to geographical location and/or building design
- Built-in remote monitoring hardware allows cloud controlled adjustments to the booster anytime and anywhere via mobile SureCall Cloud app (iPhone | Android)
- Each band is independently configurable to function in the most challenging environments
- Customizable kitting and multi-amplifier scalability provide the flexibility to accommodate any floor plan
- Powerful in-building booster with 50 dB of adjustable gain level
- Automatic oscillation detection and protection system prevent harmful radio interference

1.3 Additional Items Needed

The booster requires the following additional components for a complete installation:

- An outside antenna (such as SC-530W Yagi or SC-588W omni-directional antenna)
- Sufficient low loss 50 ohm interior/exterior cable
- Multiple indoor antennas (such as, omni-directional dome SC-522W, SC-528W Ultra Thin™ or directional panel SC-548W)
- Cable splitter(s) for indoor antennas multiple antennas
- Grounded surge suppressor for DC power supply
- Lightning surge protector (SC-LP)
- Ethernet cable to connect the booster to your router (for Sentry monitoring)

1.4 How Cellular Signal Boosters Work

The Force8 booster amplifies cellular signals from the nearest tower to phones in a building and from those phones back to the tower to compensate for weak reception caused by distance, topography, building structure, among other reasons.

The booster receives the signal from an outside antenna, amplifies that signal and rebroadcasts it indoors via the

* Performance and coverage area are dependent upon the strength of cell signal outside of the building and density of structure and materials inside of the building.

Chapter 1: Introduction





interior antenna(s) where it is received by cellular devices. The interior antennas also pick up signals from cellular devices and pass them to the booster. The booster amplifies these signals and passes them to the exterior antenna for rebroadcast back to the tower.

1.5 Optional Accessories

SureCall offers compatible antennas and accessories for the Force8.

Accessories & Connectors	
SC-LP	Lightning Protector
SC-Mount-Pole	L Bracket mount with U bolt hardware for donor antenna mount to J-bar
SC-Mount-JBar	Steel 1 inch J-Bar mount for donor antenna. Antenna mount not included
SC-WS-2-5G	Ultra -Wideband 2 Way Splitter
SC-WS-3-5G	Ultra -Wideband 3 Way Splitter
SC-WS-4-5G	Ultra -Wideband 4 Way Splitter
SC-C-6-5G	Ultra -Wideband -6 dB Coupler
SC-C-10-5G	Ultra -Wideband -10 dB Coupler
SC-C-15-5G	Ultra -Wideband -15 dB Coupler
SC-C-20-5G	Ultra -Wideband -20 dB Coupler

Antenna Options

Antennas				
	Model	Type	Max Gain	Use
Outside Antenna Options				
	SC-588W	Omnidirectional	1.5 / 2 / 4 dBi	Ultra-wideband Omnidirectional Antenna; 50 Ω
	SC-530W	Directional	7 / 8 / 9 dBi	Ultra-wideband Directional Yagi Antenna; 50 Ω; pole mounted
Inside Antenna Options				
	SC-522W	Omnidirectional	1.5 / 2 / 5 dBi	Ultra-Wideband Omnidirectional Dome Antenna; 50 Ω; Ceiling mount
	SC-528W	Omnidirectional	2 / 4 / 6 dBi	Ultra -Wideband Ultra Thin™ Omnidirectional Antenna; 50 Ω; Ceiling mount
	SC-548W	Directional	5.5 / 6 / 8 dBi	Ultra-Wideband Directional Panel Antenna; 50 Ω; Wall mount

CHAPTER 2: SAFETY

This chapter contains important safety information designed to prevent personal injury, equipment malfunction, and/or radio interference. You are responsible for ensuring a safe installation.

2.1 Safety Warnings

- You are responsible for knowing and following all applicable codes and regulations and for obtaining all required permits and inspections.
- Follow all safety precautions contained in this Installation Manual.
- The installation process may require working in high locations such as roofs and/or ladders. Follow applicable safety regulations and best practices to injury. Take care not to drop objects off any high area. Cordon off ground areas directly below roof or ladder work.
- Always use appropriate personal protective equipment such as goggles, gloves, hard hat, etc. as needed or required.



WARNING: FAILURE TO EXERCISE CAUTION WHEN WORKING IN HIGH AREAS COULD CAUSE A FALL AND PERSONAL INJURY.

- Some components may be heavy and/or bulky. Always use proper lifting and carrying techniques when handling components, especially when working on a ladder, roof, or other area with a fall hazard.
- The exterior antenna must not be co-located or operating in conjunction with any other antenna.
- Always use a properly installed SureCall lightning protector between the exterior antenna and the booster.



CAUTION: FAILURE TO PROPERLY INSTALL A LIGHTNING PROTECTOR CAN RESULT IN DAMAGE TO THE BOOSTER, ANTENNAS, AND WIRING.

- Always power off the booster before working on the roof of the building or anywhere in close proximity to the external antenna.
- Allow at least 24 inches (60 cm) of separation between interior antennas and humans or animals.
- Allow at least 24 inches (60 cm) of separation between exterior antennas and all persons.
- Comply with all antenna separation requirements to prevent signal oscillation.



CAUTION: SIGNAL OSCILLATION CAN CAUSE RADIO INTERFERENCE WITH CELLULAR TOWERS AND RESULT IN CIVIL AND/OR CRIMINAL PENALTIES.

CHAPTER 3: PLANNING THE INSTALLATION

3.1 Installation Overview

Force8 Bi-Directional Amplifier (BDA) installation steps:

Decide what type of exterior antenna to use, and where to mount it. You will use either an omnidirectional antenna, mounted vertically, or a directional Yagi antenna, pointed directly at the radio tower (line of sight). The antenna will normally be mounted on the roof of the building or wall with the strongest signal. A grounded lightning protector is required between the exterior antenna and the BDA.

1. Decide where to mount the interior antenna(s), being sure to take separation requirements into account. Long, narrow spaces benefit most from directional flat-panel antennas, while more square spaces benefit more from omnidirectional dome antennas.
2. Decide where to mount the BDA. This should be in a secure indoor location near a grounded power source.
3. Decide where to route the cables between the exterior antenna and the BDA and between the BDA and interior antennas.
4. Install the antennas as described in their respective Installation Manuals.
5. Route the cables to the BDA location.
6. Install the BDA as described in this manual.
7. Power on the BDA and perform configuration and testing explained in Chapter 5.

Important Installation Safety Precautions:



CAUTION: FAILURE TO PROPERLY INSTALL A LIGHTNING PROTECTOR CAN RESULT IN DAMAGE TO THE BDA, ANTENNAS, AND WIRING.

- Some components may be heavy and/or bulky. Always use proper lifting and carrying techniques when handling components, especially when working on a ladder, roof, or other area with a fall hazard.
- The exterior antenna must not be co-located or operating in conjunction with any other antenna.
- Always use a properly installed SureCall lightning protector between the exterior antenna and the BDA.
- Always power off the BDA before working on the roof of the building, or anywhere in close proximity to the external antenna.

Chapter 3: Planning The Installation

- Allow at least 24 inches (60cm) of separation between interior antennas and humans or animals.
- Allow at least 24 inches (60cm) of separation between exterior antennas and all persons.
- Comply with all antenna separation requirements to prevent signal oscillation.



CAUTION: SIGNAL OSCILLATION CAN CAUSE RADIO INTERFERENCE WITH RADIO TOWERS AND RESULT IN CIVIL AND/OR CRIMINAL PENALTIES.

3.2 Exterior Antenna

You may use either an omnidirectional antenna that covers flat areas with no obstructions or a directional Yagi antenna to point directly at the tower. The omnidirectional antenna receives and transmits signals over a horizontal 360-degree circle. The Yagi antenna receives and transmits signals over a focused area and must be aimed directly (line of sight) toward the radio tower that provides the strongest signal to the building.

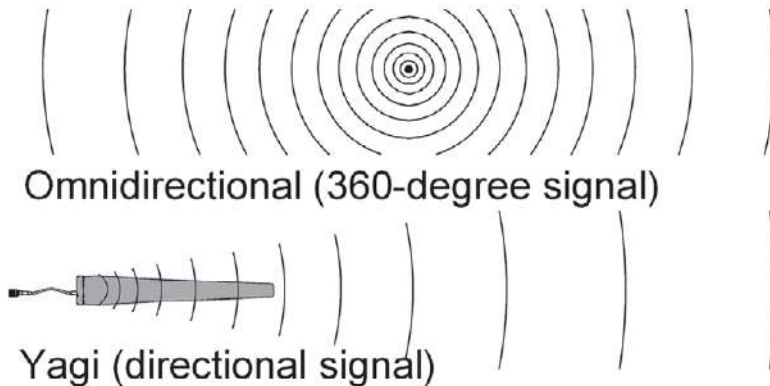

The exterior antenna and mast (if any) must be mounted in a location that meets all of the following criteria:

- Best signal strength.
- Not co-located with other antennas or used in conjunction with other antennas.
- Away from all power lines.
- At least 6 ft. from lightning rod antennas.
- At least 24 in. from any person.

3.3 Interior Antennas

You may use any combination of omnidirectional (dome) and/or directional (flat panel) interior antennas to obtain balanced signal strength throughout the structure.

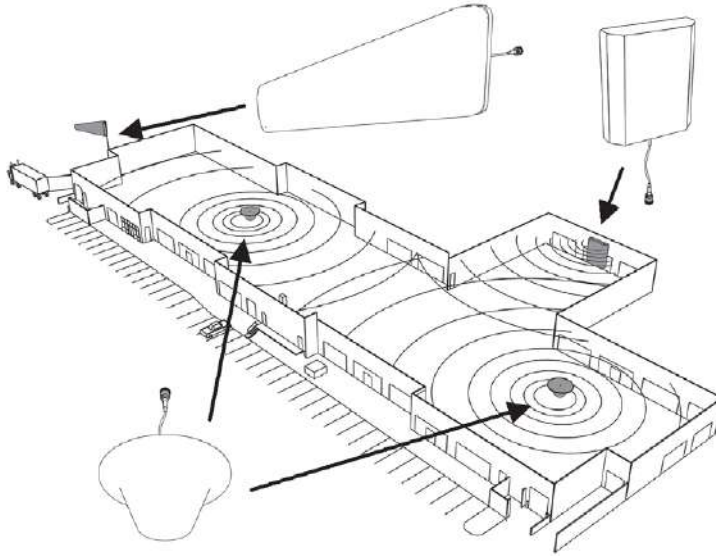

Dome antennas provide 360-degree hemispherical coverage suitable for mostly square areas, while flat panel antennas provide a focused zone of coverage suitable for long narrow areas. The example above uses two dome antennas and one panel antenna to provide full coverage

Keep in mind that floor structures in multistory buildings can cause significant signal loss, which means that you may need to install interior antennas on more than one floor. Here is an example of a multistory installation:

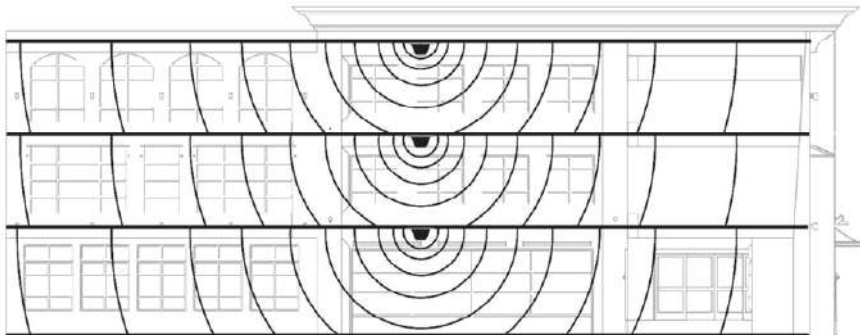

Chapter 3: Planning The Installation

Note: You may not need antennas on every floor of a multistory building, depending on factors such as building material, BDA gain, etc.

3.4 Antenna Separation

Proper antenna separation prevents signal oscillation (feedback) that can interfere with the radio tower. Separation is measured in a straight line from the exterior antenna to the closest interior antenna. The closest allowable distance depends on a number of factors, such as BDA gain level, building material, etc. Recommended separation distances are:

Amplifier gain	Min. separation (ad)
40 dB	5'-6'
45 dB	15'-20'
50 dB	50'
55 dB	60'
65 dB	75-80'
70 dB	100'
75 dB	100'-120'
80 dB	120'-180'

Vertical separation is more important than horizontal separation. If you are unable to obtain the required separation horizontally, try raising the exterior antenna. You may also try reducing the BDA gain as described in Chapter 5 of this manual.

FCC 15.105: This equipment has been tested and found to comply with the limits for a Class B digital device, pursuant to part 15 of the FCC Rules. These limits are designed to provide reasonable protection against harmful interference in a residential installation. This equipment generates, uses and can radiate radio frequency energy and, if not installed and used in accordance with the instructions, may cause harmful interference to radio communications. However, there is no guarantee that interference will not occur in a particular installation. If this equipment does cause harmful interference to radio or television reception, which can be determined by turning the equipment off and on, the user is encouraged to try to correct the interference by one or more of the following measures:

- Reorient or relocate the receiving antenna
- Increase the separation between the equipment and receiver.
- Connect the equipment into an outlet on a circuit different from that to which the receiver is connected
- Consult the dealer or an experienced radio/TV technician for help.

Chapter 3: Planning The Installation

Antenna Safety Precautions:

You can mix and match dome and directional antennas as needed to obtain proper coverage throughout the building or area where you need to boost the signal. If you use a Yagi exterior antenna, you should normally aim it away from all interior antennas, regardless of separation, to prevent oscillation.

Antenna Aiming

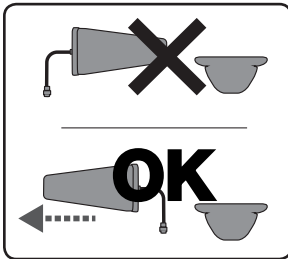

CAUTION: SIGNAL OSCILLATION CAN CAUSE RADIO INTERFERENCE WITH RADIO TOWERS AND RESULT IN CIVIL AND/OR CRIMINAL PENALTIES.

3.5 Calculating Signal Strength

You can calculate the number of antennas you will need using the following parameters (in dB):

- Outside signal level (OSL): This is the signal strength at the exterior antenna location and will always be a negative number that will usually fall between -50 and -100 dBm. Calls will drop at levels of about -100 dB and lower. A system installed in an area where the signal is -85 or worse will require some detailed engineering to achieve an acceptable solution.
- Outside antenna gain (OAG): This is the signal boost provided by the exterior antenna and is always a positive number with SureCall antennas.

OAG	Gain
SC-588W omni	+3

Chapter 3: Planning The Installation

- Inside antenna gain (IAG): This is the signal boost provided by an interior antenna and is always a positive number with SureCall antennas.

IAG	Gain
SC-522W dome	+3

- Cable loss (CL): This is the signal loss caused by the cable and is always a negative number.

CL	Loss
20 ft. SC-400	-1 dB / -2 dB
30 ft. SC-400	-2 dB / -4 dB
50 ft. SC-400	-3 dB / -6 dB
100 ft. SC-400	-4 dB / -8 dB

- Splitter loss (SL): This is the signal loss caused by a splitter (used if you are installing multiple antennas).

SL	Loss
2-way	-3
3-way	-5
4-way	-6

- Booster gain (AG): Number of decibels of amplification provided by the booster (rated gain less any attenuation, as described in Chapter 5 of this manual). This is always a positive number.

The signal strength S at an interior antenna equals $OSL+OAG+IAG+CL+SL+AG$.

Chapter 3: Planning The Installation

3.6 Booster Location

Select an indoor location for the BDA that meets the following criteria:

- Wall or ceiling mounts are both acceptable.
- Near a properly grounded 110VAC outlet.
- Avoid in a tightly enclosed or overly hot spaces.
- All power and warning lights are easily visible.
- You can use the shortest cables to connect all antennas.

3.7 Accessories

The final step in the planning process is to make sure you have all of the necessary accessories to complete the installation. You will need all of the items listed in Chapter 1 of this manual plus some or all of the following:

- Cable clips: Use these to secure the cables to interior and exterior walls/ceilings.
- Appropriately rated sealant/caulking: Use this to waterproof the opening where the cable from the exterior antenna enters the building, if needed.
- Hand and/or power tools: As needed to complete the installation.
- Personal Equipment (PPE): Use all PPE required by local codes and/or best practices to help ensure personal safety during installation.



CAUTION: YOU ARE RESPONSIBLE FOR ENSURING THAT THE INSTALLATION MEETS ALL APPLICABLE CODES.

Note: You may need to obtain a permit from your local building department to install the BDA and antennas. Check your local building and/or electrical codes.

3.8 Need Help?

If you need help planning your installation, contact a qualified installer, the reseller who supplied you with the BDA, or SureCall:

Call: 1-855-846-2654, 7 a.m. to 5 p.m. PST, Monday – Friday

CHAPTER 4: INSTALLATION

4.1 Soft Installation

Perform a “soft” installation of all components to test signal coverage and oscillation before making the installation permanent. Avoid making holes or other permanent attachments during this phase. Refer to Chapter 5 for configuration and testing instructions. Proceed with final installation once configuration and testing are complete.

4.2 Exterior Antenna

Mount the exterior antenna in the location you selected during the planning process. Be sure to follow all of the instructions included with the antenna to ensure a safe installation. Remember:

- Omni-directional antennas, like the SC-588W, must be mounted vertically.
- Directional antennas, like the SC-530W Yagi antenna, must be mounted horizontally and aimed toward a cellular tower (line of sight)

Follow the instructions for installation of your chosen antenna. Once completed:

1. Connect one end of SC-400 cable to the antenna and hand tighten.
2. Run the cable along the planned route.
3. Install a properly grounded SC-LP lightning protector.
4. Seal any holes you make in the outside of the building with caulking or sealant.



WARNING: FAILURE TO EXERCISE CAUTION WHEN WORKING IN HIGH AREAS COULD CAUSE A FALL AND PERSONAL INJURY.



WARNING: DO NOT TOUCH ANY LIVE ELECTRICAL WIRES OR ALLOW THE ANTENNA OR CABLING TO TOUCH ANY LIVE ELECTRICAL WIRES.



CAUTION: AVOID AIMING A YAGI ANTENNA TOWARD ANY INTERIOR ANTENNA.

4.3 Interior Antennas

Mount the interior antenna(s) in the location(s) you selected when planning. Follow all instructions included with the antenna(s) to ensure the installation(s) are implemented properly.

Here are a few reminders and essential steps:

- Dome antennas are mounted on the ceiling as close to the center of the desired coverage area as possible, domed (convex) side pointing down.
- Flat panel antennas should be wall-mounted as close as possible to the center of the wall, or at one end of long narrow space.
- Mount the antenna(s).
- Connect a length of cable to the antenna and tighten.
- For multiple antennas, run the cable to the splitter location and connect the cable to one of the outputs on the splitter.
- Connect another length of cable to the input side of the splitter (if used) and run this cable to the BDA location.
- It is important to keep the cable runs equal or use taps to ensure a harmonious install.



CAUTION: VERIFY THAT ALL INTERIOR ANTENNAS MEET THE SEPARATION REQUIREMENTS DESCRIBED IN THE PREVIOUS CHAPTER, AND THAT NO ANTENNA IS AIMED TOWARD THE EXTERIOR ANTENNA.



CAUTION: DO NOT CONNECT AN INTERIOR ANTENNA TO THE SPLITTER INPUT.

Chapter 4: Installation

4.4 Mounting the BDA

Mount the booster as follows:

- Verify that the selected location meets all criteria described in the previous chapter.
- Attach the included mounting kit to the booster using the screws provided. Tighten the screws by hand with a screwdriver until tight plus 1/4 to 1/2 turn. Do not over-tighten.
- Mount a 24 inch x 24 inch x 3/4 inch thick sheet of plywood on top of sheetrock, secured into wall studs where the booster is to be placed. The plywood should be flush against wall.
- Once the plywood is secure, attach booster to the plywood base using the screws provided. In most installations, the housing will be oriented so the I/O ports are facing down.
- Connect the outdoor antenna cable to the signal booster connector port marked OUTSIDE and tighten the connection.
- Connect the outdoor antenna cable to the signal booster connector port marked INSIDE and tighten the connection.



**CAUTION: DO NOT POWER ON THE BDA
UNTIL INSTRUCTED TO DO SO.**



**CAUTION: NEVER POWER ON THE BDA
WHEN ANY ANTENNAS ARE DISCONNECTED
AS THIS COULD DAMAGE THE BDA.**

CHAPTER 5: CONFIGURATION & TESTING

5.1 Powering on the BDA

To power on the booster:

1. Make sure that exterior and interior antenna cables are firmly connected to the proper ports on the booster.
2. Plug a surge suppressor into a grounded 110 VAC wall outlet.
3. Plug the AC end of the supplied power adapter into the surge suppressor.
4. Plug the DC end of the power adapter into the Power port on the booster.
5. Verify that the green Power light is illuminated.
6. When the booster is turned on, the band lights will flash red and yellow for approximately 10 seconds.



CAUTION: ONLY USE THE POWER SUPPLY INCLUDED WITH THE BDA. USE OF ANOTHER POWER SUPPLY COULD DAMAGE THE BDA AND/OR POWER SUPPLY.



CAUTION: DO NOT PROCEED BEYOND THIS POINT UNTIL THE BDA IS POWERED ON AND NO RED WARNING LIGHTS ARE ILLUMINATED.

5.2 DIP Switch Configuration

By default, your booster ships with all DIP switches turned OFF to provide maximum gain in all channels. This should always be your starting point whenever installing or reinstalling the booster. When the booster is turned on, the band lights will flash red and yellow for approximately 10 seconds. The following diagrams and notes explain how to interpret, and use, these switch banks.

5.3. DIP Switch organization

1. 5G DL DIP switches control 5G downlink (switch 1-5)
2. 5G / LTE-A UL DIP switches control 5G & LTE-A uplink (switch 1-5)
3. LTE DL DIP switches control LTE downlink (switch 1-5)
4. LTE-V UL Verizon DIP switches control LTE uplink (switch 1-5)
5. CELLULAR UL (800 MHz) DIP switches control Cellular uplink (switch 1-5)
6. CELLULAR DL (800 MHz) DIP switches control Cellular downlink (switch 1-5)
7. PCS UL (1900 MHz) DIP switches control PCS uplink (switch 1-5)
8. PCS DL (1900 MHz) DIP switches control PCS downlink (switch 1-5)
9. EAWS UL DIP switches control EAWS uplink (switch 1-5)
10. EAWS DL DIP switches control EAWS downlink (switch 1-5)

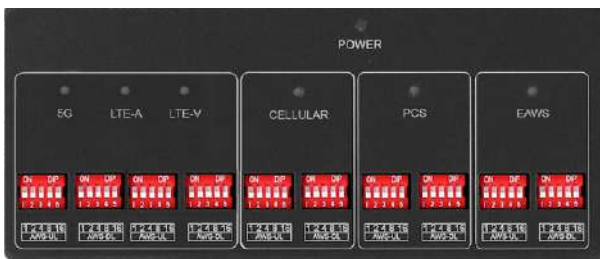

Switches should be OFF unless flashing red/yellow flashing lights occur for a channel or channels. Red/yellow flashing lights indicate the system has detected oscillation for the corresponding channel(s). They then turn off if adjustments are not made. When adjusting the booster, full power is not always the best option. Your goal is to obtain a usable signal in as many areas of the building as possible.

Switch 1	Switch 2	Switch 3	Switch 4	Switch 5
1 dB	2 dB	4 dB	8 dB	16 dB

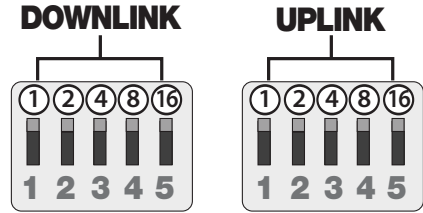

Additive combination effects:

- Switch 1 (1 dB) + Switch 2 (2 dB) = 3 dB attenuation
- Switch 1 (1 dB) + Switch 2 (2 dB) + Switch 3 (4 dB) = 7 dB attenuation
- Switch 1 (1 dB) + Switch 2 (2 dB) + Switch 3 (4 dB) + Switch 4 (8 dB) = 15 dB attenuation
- Switch 1 (1 dB) + Switch 2 (2 dB) + Switch 3 (4 dB) + Switch 4 (8 dB) + Switch 5 (16 dB) = 31 dB attenuation

A few practical examples:

- Turning all switches OFF = 0 dB attenuation (booster is at full gain).
- Turning ON switch #1 in a bank = 1 dB attenuation (booster maximum gain is reduced by 1 dB).
- Turning ON switches #1, 3, and 5 in a bank = 1+4+16 dB attenuation = 21 dB attenuation. For example, in an 80 dB booster, the selected channel is reduced to 59 dB (80 dB -21 dB).
- Turning ON all switches in a bank = 1+2+4+8+16 dB attenuation = 31 dB attenuation. For example, in an 80 dB booster, the selected channel is reduced to 49 dB (80 dB-31 dB).

When the booster is powered on, the green Power light should illuminate.

- If any of the bands are oscillating, the corresponding band lights will flash Yellow/Red. This means that further separation between inside and outside antennas is required.

Note: When the booster is turned on, the band lights will flash red and yellow for approximately 10 seconds.

Note: In general, the uplink and downlink DIP switches should be set identically but this is not always the case.

5.4 LED Conditions

This section will help you interpret the LED indicators on your Force8. But first, here are a few configuration and testing points to keep in mind:

- When choosing a location for the outside antenna, a minimum signal reading of -100 dB is needed if measuring using your mobile device. A signal in the -70 dB to -90 dB range is recommended for best performance. For those using a signal meter to measure strength, a reading of -60 dB to -70 dB is recommended.
- It is recommended that all DIP switches be left in the off position (facing down) during installation and only activated as needed per LED indicators.
- The booster DIP switches should remain in the off position (facing down) during installation and only activated as needed per LED indicators. In any case, the first course of action should be antenna adjustments.
- Avoid applying more than 25 dB of attenuation through the DIP switches, as anything over that amount can cause the affected band to shut off completely while displaying a solid red LED.

Chapter 5: Configuration & Testing

LED INDICATIONS

LED Color	LED Condition	Resolution
Green	Solid	Indicates that the bands are active and operating normally.
Green	Flashing	The Automatic Gain Control (AGC) is self-adjusting. This occurs during normal operation.
Yellow/ Red	Alternately flashing	Self-oscillation has been prevented. Try this: <ol style="list-style-type: none">1. Increase the separation between the inside and outside antennas. If your booster kit uses two directional antennas (example: outside Yagi antenna and inside panel antenna), ensure that they are facing away from each other.2. If the condition continues, lower the dB gain setting in small increments until the light turns off or flashes yellow.3. After each adjustment of the gain, it is recommended that the booster be power cycled.

Refer to your Sentry Monitoring Software for more information about LED codes. Meanwhile, if you have any questions during setup, please reach out to our technical support : 1-855-846-2654

5.5 Testing & Troubleshooting

Once the booster is powered on (and no Warning lights are on), walk around the area to assess the voice and/or data signal in representative variety of locations. Refine the antenna locations and/or gain levels as needed, and then complete the permanent installation when you are confident the system will perform well.

A few tips and some perspective:

- It's not realistic to expect full reception everywhere in the building.
- If LEDs are alternating red and yellow flashes, it indicates there is oscillation on that band and further separation between indoor and outdoor antennas is necessary.
- If you can't get the coverage reasonably well-balanced, you may need to install an additional interior antenna and/or a different type of interior antenna and/or relocate interior antennas.

CHAPTER 6: SENTRY CONFIGURATION

Sentry Software Introduction

SureCall's Sentry is a revolutionary advancement in signal-booster management. It aids in the installation, optimization, and ongoing management of your Force8 BDA. It provides installers with tools for seamless system configurations, and it helps pinpoint malfunctions due to unforeseen changes in the amplifier landscape, such as new towers or repeater systems. Sentry also notifies installers or end users about various parameters via email. Features include:

- Quick notification about booster changes and over-power situations.
- Allows offsite monitoring and adjustments related to booster performance, such as uplink, downlink or bands.
- Helps optimize installations by monitoring and identifying the strongest signal strength available.

6.1 Software Installation

To install and configure the server, follow these steps:

- Get the SureCall Sentry software from your device supplier, or download the Windows software here: surecall.com/product/Sentry.html
- Install the software using the steps outlined below.
- Configure the server to a static IP or public IP address.
- In order to function on the network correctly, the server and the Force8 device must be (a) on the same Local Area Network, or (b) the server must be the front end to the device.
- Use appropriate security software for safe and reliable operation when connected to a network.
- All device and user information will be stored on the computer.

Double-click [ClientUserSetup](#) to start the installation, which takes you to Welcome screen.

Note: To avoid install glitches, we recommend you close all other Windows programs running on your computer before proceeding.

After you have shut down other programs, click Next, which will take you to the User Information screen shown below. This is where you'll enter user information. It may be you as the installer, or you may be setting this up for someone else who will be monitoring the system on an ongoing basis.

6.2 Hardware Installation

Once the Sentry software is installed, you can proceed to connect and configure the Force8 BDA.

- Connect the USB cable (provided) to the Booster's USB port then connect the other end of the USB cable to the USB port on your computer. The USB is only needed for configuration and may be disconnected once complete.
- Connect an Ethernet cable to the booster's WAN port and connect the other end to your router.
- Once the connections are made, power on the Force8 BDA.
- Start the Sentry client application software. You will see the screens below:

Chapter 6: Sentry Configuration

6.3 User Registration

You'll need to register an account. Connect your computer to the network. A secure LAN connection is important because it will allow the computer to "see" the device on the network. Fill in the User Registration form and choose a user name, password, email and user phone. Once completed, click the Register button.



Click Register and you'll see the following screen, prompting you to enter the local Server IP address.



Enter SureCall's server IP: 12.199.204.133 in the Registration Window.

User Name	<input type="text"/>
Password	<input type="password"/>
Confirm Password	<input type="password"/>
E-mail	<input type="text"/>
User Phone	<input type="text"/>
Purchased Extension	<input type="checkbox"/>
Purchased from	<input type="text"/>

Enter a User Name, Password, E-mail, and User Phone in the fields provided. Then click Register to proceed. You will the Login screen again, as shown in the next screen.



In the fields provided, enter the Username and Password that you registered on the system. This will enable you to proceed to device configuration, as explained in the steps below:

6.4 Device Registration

Connect the device to the networked client computer with a USB cable as described in the previous section. Make sure the server is also linked to the computer. Select a serial port and click Open, as shown in the Add Booster screen below.

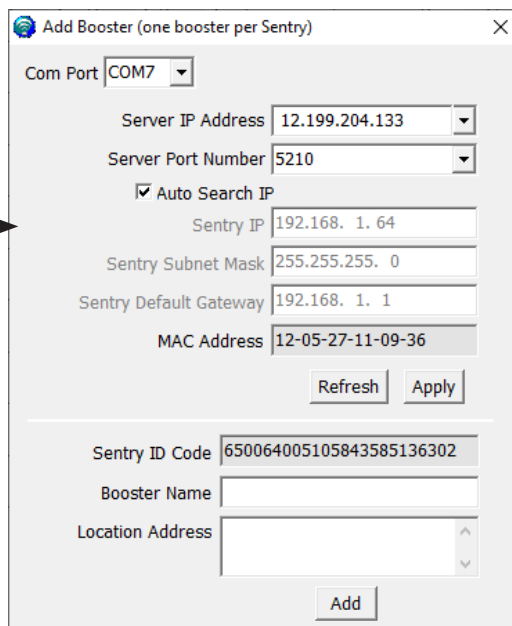
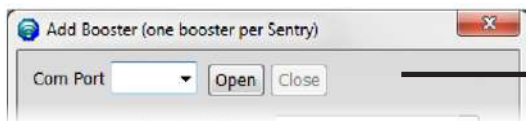
A screenshot of the 'Add Booster (one booster per Sentry)' dialog box. The 'Com Port' dropdown is set to 'COM7'. The 'Server IP Address' is '12.199.204.133' and the 'Server Port Number' is '5210'. The 'Auto Search IP' checkbox is checked. The 'Sentry IP' is '192.168. 1. 64', 'Sentry Subnet Mask' is '255.255.255. 0', and 'Sentry Default Gateway' is '192.168. 1. 1'. The 'MAC Address' is '12-05-27-11-09-36'. There are 'Refresh' and 'Apply' buttons. Below these are fields for 'Sentry ID Code' (650064005105843585136302), 'Booster Name', and 'Location Address'. An 'Add' button is at the bottom.

Complete device registration as described below:

- Click Refresh to query device parameters
- Enter a name in the Booster Name field
- Enter the location in the Location Address field (optional)
- Click Add to register the device on the server
- Keep in mind that only the registered user is authorized to see/operate the added device.

6.5 Device Configuration

Using the same screen as before, configure the device according to the steps below.

- Select a serial port and click Open.
- Click Refresh to query device parameters.
- Click on the drop-down menu and select a server IP address and port number to make sure the device can be connected to the server.
- Dynamic IP is available by checking Auto Search IP function, OR... enter IP parameters manually, if the device needs a static IP.
- Click Apply to finish the configuration.

The following summary screen appears if the booster connects to the server successfully:

Chapter 6: Sentry Configuration

Sentry Remote Monitoring and Control System(V2.4)

Tools

Type: Force8 Sentry ID Code: 650064005105843585136302

Band (s)	Channel	Attenuation	Manual Attenuation	Automatic Gain Control Attenuation	Gain	Output Power	Outside Signal Strength	Uplink/Downlink Status	Band On/Off	Over Power	Oscillation	Manual Shut Off
5G Band71	Uplink 662-698M	0 dB	0 dB	0 dB	80 dB	-10 dBm		Yellow Sleep	ON	Green Normal	Green Normal	Green Normal
	Downlink 617-652M	0 dB	0 dB	0 dB	80 dB		-91 dBm	Green ON	ON	Green Normal	Green Normal	Green Normal
LTE-A Band12	Uplink 699-716M	0 dB	0 dB	0 dB	80 dB	-10 dBm		Yellow Sleep	ON	Green Normal	Green Normal	Green Normal
	Downlink 728-746M	0 dB	0 dB	0 dB	80 dB		-96 dBm	Green ON	ON	Green Normal	Green Normal	Green Normal
LTE-V Band13	Uplink 779-787M	0 dB	0 dB	0 dB	80 dB	-6 dBm		Yellow Sleep	ON	Green Normal	Green Normal	Green Normal
	Downlink 746-757M	0 dB	0 dB	0 dB	80 dB		-96 dBm	Green ON	ON	Green Normal	Green Normal	Green Normal
ESMR Band27	Uplink 819-824M	0 dB	0 dB	0 dB	80 dB	9 dBm		Yellow Sleep	ON	Green Normal	Green Normal	Green Normal
	Downlink 864-869M	0 dB	0 dB	0 dB	80 dB		-94 dBm	Green ON	ON	Green Normal	Green Normal	Green Normal
Cellular Band5	Uplink 824-849M	0 dB	0 dB	0 dB	80 dB	-9 dBm		Yellow Sleep	ON	Green Normal	Green Normal	Green Normal
	Downlink 869-894M	0 dB	0 dB	0 dB	80 dB		-94 dBm	Green ON	ON	Green Normal	Green Normal	Green Normal
FCCS Band25	Uplink 1830-1915M	0 dB	0 dB	0 dB	80 dB	-3 dBm		Green Active	ON	Green Normal	Green Normal	Green Normal
	Downlink 1930-1995M	0 dB	0 dB	0 dB	80 dB		-86 dBm	Green ON	ON	Green Normal	Green Normal	Green Normal
LAWS Band10	Uplink 1710-1780M	0 dB	0 dB	0 dB	80 dB	-3 dBm		Yellow Sleep	ON	Green Normal	Green Normal	Green Normal
	Downlink 2110-2180M	0 dB	0 dB	0 dB	80 dB		-84 dBm	Green ON	ON	Green Normal	Green Normal	Green Normal

Column Definitions:

- **Attenuation:** Manually adjusted attenuation via software.
- **Manual Attenuation:** Manually adjusted attenuation using controls on the device.
- **Automatic Gain Control:** Automatically adjusted attenuation from excessive signal
- **Gain:** Current gain.
- **Output Power:** Current power.
- **Outside Signal Strength:** Strength of input signal.
- **Uplink/Downlink Status:** RF band status: Sleep, Active, OFF.
- **Over Power:** Over-power alert status: Red=Alert; Green=Normal.
- **Oscillation:** Oscillation-alert status: Red=Alert; Green=Normal.
- **Over Attenuation:** Manual over-attenuation status: Red=Alert; Green=Normal.



NOTE: BOTH THE MANUALLY ADJUSTED ATTENUATION BY DEVICE AND BY SOFTWARE CANNOT EXCEED 25 DB.

Chapter 6: Sentry Configuration

Modify Booster Information. To modify the booster information, right click to access a pop-up menu with the following additional options. Select Edit Booster Info to proceed.

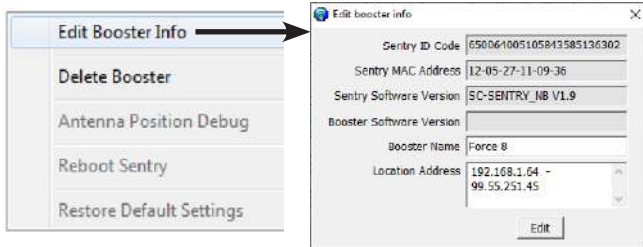

Delete Booster. To delete a booster, right click on the summary screen again to access a pop-up menu with additional options, and then select Delete Booster.

You will see a confirmation screen as shown below. Click Yes to proceed.

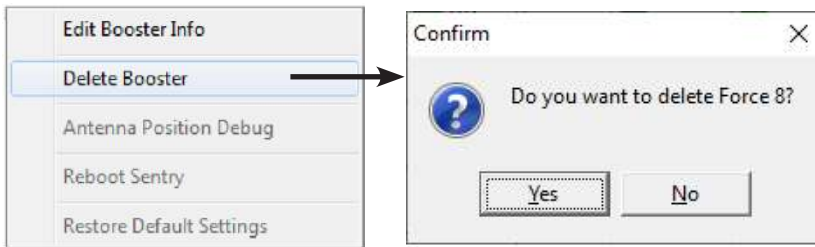

Password and E-mail Management: In the Tools pull-down menu, you can change your account information, including your password, or the e-mail address for status reports. Roll over the Accounts heading and click on Modify Password/E-mail to access this feature.

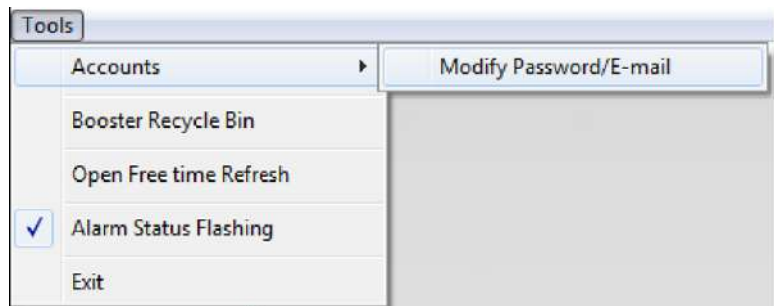

Chapter 6: Sentry Configuration

To modify your password, type in the requested information shown below and click on Modify.

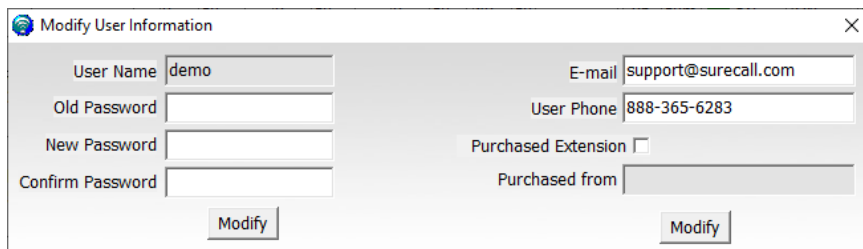

The screenshot shows a 'Modify User Information' dialog box. It has a title bar with a globe icon and a close button. The form is divided into two columns. The left column contains: 'User Name' with the value 'demo', 'Old Password' (empty), 'New Password' (empty), and 'Confirm Password' (empty). The right column contains: 'E-mail' with the value 'support@surecall.com', 'User Phone' with the value '888-365-6283', 'Purchased Extension' with an unchecked checkbox, and 'Purchased from' (empty). At the bottom of each column is a 'Modify' button.

To change the e-mail address where alerts go, enter a new e-mail as shown above and click on Modify.



NOTE: IF YOU FORGET YOUR PASSWORD, CLICK FORGOT MY PASSWORD ON THE LOGIN PAGE.
THE PASSWORD WILL BE SENT TO YOUR E-MAIL ADDRESS.

6.6 Over Power Alert

If Red=ON, it means the input signal is too strong. Here are four possible solutions to try:

1. Relocate the outdoor antenna to a location where the signal is weaker. Or, If using a Yagi outside antenna, turn in small increments away from cell tower until Red alert is resolved.
2. Add an inline 5 dB or 10 dB attenuator (parts: SC-ATNR-5 and SC-ATNR-10) to the cable coming into the booster.
3. Lower the dB gain in small increments on the Sentry booster dashboard under the Attenuation column until the Over Power alert is resolved.



ATTENUATION THROUGH CLIENT SOFTWARE IS CUMULATIVE WITH THAT OF DIP SWITCHES.

Email Alerts Email alerts will be sent in the event of booster overpowering, manual shut-off, or if oscillation is detected.

Chapter 6: Sentry Configuration

Sentry Remote Monitoring and Control System(V2.4)

Tools: Add Booster Create Folder

Type: Force8 Name: Force 8 Address: 192.168.1.64 - 99.55.251.45

Band	Channel	Attenuation	Manual Attenuation	Automatic Gain Control Attenuation	Gain	Output Power	Outside Signal Strength	Uplink/Downlink Status	Band On/Off	Over Power	Oscillation	Manual Shut Off
SG Band71	Uplink 663-698M	0 dB	0 dB	0 dB	80 dB	-10 dBm		Sleep	ON	Normal	Normal	Normal
	Downlink 617-652M	0 dB	0 dB	0 dB	80 dB		-91 dBm	ON	ON	Normal	Normal	Normal
LTE-A Band12	Uplink 698-716M	0 dB	0 dB	0 dB	80 dB	-10 dBm		Sleep	ON	Normal	Normal	Normal
	Downlink 728-746M	0 dB	0 dB	0 dB	80 dB		-96 dBm	ON	ON	Normal	Normal	Normal
LTE-V Band13	Uplink 776-787M	0 dB	0 dB	0 dB	80 dB	-6 dBm		Sleep	ON	Normal	Normal	Normal
	Downlink 746-757M	0 dB	0 dB	0 dB	80 dB		-96 dBm	ON	ON	Normal	Normal	Normal
ESMR Band27	Uplink 819-824M	0 dB	0 dB	0 dB	80 dB	-9 dBm		Sleep	ON	Normal	Normal	Normal
	Downlink 864-869M	0 dB	0 dB	0 dB	80 dB		-94 dBm	ON	ON	Normal	Normal	Normal
Cellular Band5	Uplink 824-849M	0 dB	0 dB	0 dB	80 dB	-9 dBm		Sleep	ON	Normal	Normal	Normal
	Downlink 869-894M	0 dB	0 dB	0 dB	80 dB		-94 dBm	ON	ON	Normal	Normal	Normal
EPCS Band25	Uplink 1850-1915M	0 dB	0 dB	0 dB	80 dB	-3 dBm		Active	ON	Normal	Normal	Normal
	Downlink 1930-1955M	0 dB	0 dB	0 dB	80 dB		-87 dBm	ON	ON	Normal	Normal	Normal
EAWS Band10	Uplink 1710-1780M	0 dB	0 dB	0 dB	80 dB	-3 dBm		Sleep	ON	Normal	Normal	Normal
	Downlink 2110-2180M	0 dB	0 dB	0 dB	80 dB		-85 dBm	ON	ON	Normal	Normal	Normal

Sentry Software Version: SC-SENTRY_NB V1.9 Connection Status: Normal VoLTE Sim Card: Verizon

Total Data: 2 Data Sent: 2 Data Received: 2

Server IP: 12.199.204.133 Username: demo LoginTime: 2019-12-10 09:05:53

Sentry Dashboard

From the dashboard above you can manually adjust the attenuation dB to resolve problems with oscillation and overpowering issues. You can also turn off individual bands.



ATTENUATION CAN BE LOWERED TO A MAXIMUM OF 30 OR 31 DB, DEPENDING ON THE BOOSTER MODEL AND A MAX OF 25 DB THROUGH SENTRY SOFTWARE.

Chapter 7: Specifications

CHAPTER 7: SPECIFICATIONS

Force8 Industrial Specifications	
Bands supported:	12 (LTE-A), 13 (LTE-V), 5 (Cellular), 25 (PCS), 4 (AWS), 71 (T-Mobile 600 MHz)
Uplink	
Frequency	663-716 / 776-787 / 824-849 / 1850-1915 / 1710-1755
Nominal System Output Power	22-25 dBm
Gain	80 dB (65-70 dB for Band 71: 617-652 / 663-716)
Gain step	1 dB
Gain Adjustment Range:	50 dB
Noise Figure:	7 dB
Downlink	
Frequency	617-652 / 728-746 / 746-757 / 869-894 / 1930-1995 / 2110-2155
Nominal System Output Power	19-22 dBm
Gain	80 dB (65-70 dB for Band 71: 617-652 / 663-716)
Gain step	1 dB
Gain Adjustment Range:	50 dB
Noise Figure:	7 dB
Input / Output Impedance:	50 Ω
VWSR:	≤ 2.0
Maximum Output Power:	3 Watt EIRP
RF Connectors:	N Female, both ends
Cable:	SC-400 (not provided)
AC Power Adapter:	Input AC 110-240 V, 60 Hz / Output DC 19 V
Power Consumption:	<65W
Dimensions:	12.96 x 16.43 x 3.86 inches
Weight:	32.4 lbs
Certifications	FCC ID: RSNFORCE8-IND / IC: 7784A-FORCE8

Chapter 7: Specifications

Frequency	GSM			4.1 MHz AWGN		
	Input(dBm)	Output (dBm)	Gain (dB)	Input(dBm)	Output (dBm)	Gain(dB)
UL: 1710-1780	-62.7	22.2	84.9	-62.8	21.8	84.6
UL: 1850-1915	-61.7	22.8	84.5	-62.5	22.6	85.1
UL: 824-894	-61.2	26.2	87.4	-61.4	25.5	86.9
UL: 698-716	-63.3	21.1	84.4	-63.4	20.4	83.8
UL: 663-698	-64.0	22.5	86.5	-64.1	21.6	85.7
UL: 776-787	-57.2	23.8	81.0	-57.2	23.6	80.8
DL: 2110-2155	-61.9	22.3	84.2	-61.5	21.4	82.9
DL: 1930-1995	-63.1	20.3	83.4	-62.0	19.5	81.5
DL: 869-894	-62.7	23.7	86.4	-62.8	22.2	85.0
DL: 728-746	-61.6	21.8	83.4	-62.7	20.6	83.3
DL: 617-652	-62.9	23.9	86.8	-61.5	23.3	84.8
DL: 746-757	-59.7	22.3	82.0	-62.6	21.1	83.7

Important: Unauthorized antenna cables and/or coupling devices may not be used. Changes or modifications not expressly approved by the Surecall could void the user's authority to operate the equipment.

CHAPTER 8: WARRANTY

For questions regarding your warranty, contact CS representative at 1-855-846-2654

8.1 Warranty Periods

Your warranty includes the following periods:

Three-Year Product Warranty: SureCall products are covered under a three-year product warranty from the date of purchase. This protects the customer from any defects or problems the product may have that are solely the fault of SureCall. Incorrect installation or misuse will void this warranty. Upon the return of a defective product, SureCall will issue the customer a working replacement. All returned packages should contain all products distributed.

Five-Year Extended Product Warranty: A five year warranty is available for purchase on any products sold by SureCall. A five-year warranty must be obtained at the time of purchase. This warranty adds an additional two years to the three year warranty we provide. All regulations still apply.

8.2 Three-Year Product Warranty

SureCall warrants its products for three years from the date of purchase against defects in workmanship and/or materials. Specifications are subject to change. The three-year warranty only applies to products meeting the latest FCC Certification Guidelines stated on 2/20/2013 and going into effect April 30, 2014. A two-year warranty applies to any products manufactured before May 1, 2014.

Products returned by customers must be in their original, un-modified condition, shipped in the original or protective packaging with proof-of-purchase documentation enclosed, and a Return Merchandise Authorization (RMA) number printed clearly on the outside of the shipping container.

Buyers may obtain an RMA number for warranty returns by calling the SureCall Return Department toll-free at 1-888-365-6283. Any returns received by SureCall without an RMA number clearly printed on the outside of the shipping container will be returned to sender. In order to receive full credit for signal boosters, all accessories originally included in the signal booster box must be returned with the signal booster. (The Buyer does not need to include accessories sold in addition to the signal booster, such as antennas or cables.)

This warranty does not apply to any product determined by SureCall to have been subjected to misuse, abuse, neglect, or mishandling that alters or damages the product's physical or electronic properties.

SureCall warrants to the Buyer that each of its products, when shipped, will be free from defects in material and workmanship, and will perform in full accordance with applicable specifications. The limit of liability under this warranty is, at SureCall's option, to repair or replace any product or part thereof which was purchased up to THREE YEARS after May 1, 2014 or TWO YEARS for products purchased before May 1, 2014, as determined by examination by SureCall, prove defective in material and/or workmanship. Warranty returns must first be authorized in writing by SureCall. Disassembly of any SureCall product by anyone other than an authorized representative of SureCall voids this warranty in its entirety. SureCall reserves the right to make changes in any of its products without incurring any obligation to make the same changes on previously delivered products.

As a condition to the warranties provided for herein, the Buyer will prepay the shipping charges for all products returned to SureCall for repair, and SureCall will pay the return shipping with the exception of products returned from outside the United States, in which case the Buyer will pay the shipping charges.

The Buyer will pay the cost of inspecting and testing any goods returned under the warranty or otherwise, which are found to meet the applicable specifications or which are not defective or not covered by this warranty.

Products sold by SureCall shall not be considered defective or non-conforming to the Buyer's order if they satisfactorily fulfill the performance requirements that were published in the product specification literature, or in accordance with samples provided by SureCall. This warranty shall not apply to any products or parts thereof which have been subject to accident, negligence, alteration, abuse, or misuse. SureCall makes no warranty whatsoever in respect to accessories or parts not supplied by it.

Chapter 8: Warranty

8.3 Limitations of Warranty, Damages and Liability

EXCEPT AS EXPRESSLY SET FORTH HEREIN, THERE ARE NO WARRANTIES, CONDITIONS, GUARANTEES, OR REPRESENTATIONS AS TO MERCHANTABILITY, FITNESS FOR A PARTICULAR PURPOSE, OR OTHER WARRANTIES, CONDITIONS, GUARANTEES, OR REPRESENTATIONS, WHETHER EXPRESSED OR IMPLIED, IN LAW OR IN FACT, ORAL OR IN WRITING.

SURECALL AGGREGATE LIABILITY IN DAMAGES OR OTHERWISE SHALL NOT EXCEED THE PAYMENT, IF ANY, RECEIVED BY CELLPHONE-MATE, INC. FOR THE UNIT OF PRODUCT OR SERVICE FURNISHED OR TO BE FURNISHED, AS THE CASE MAY BE, WHICH IS THE SUBJECT OF CLAIM OR DISPUTE. IN NO EVENT SHALL SURECALL BE LIABLE FOR INCIDENTAL, CONSEQUENTIAL, OR SPECIAL DAMAGES, HOWSOEVER CAUSED.

All matters regarding this warranty shall be interpreted in accordance with the laws of the State of California, and any controversy that cannot be settled directly shall be settled by arbitration in California in accordance with the rules then prevailing of the American Arbitration Association, and judgment upon the award rendered may be entered in any court having jurisdiction thereof. If one or more provisions provided herein are held to be invalid or unenforceable under applicable law, then such provision shall be ineffective and excluded to the extent of such invalidity or unenforceability without affecting in any way the remaining provisions hereof.

WARNING: E911 location information may not be provided or may be inaccurate for calls served BY USING THIS DEVICE.

SureCall has made a good faith effort to ensure the accuracy of the information in this document and disclaims the implied warranties of merchantability and fitness for a particular purpose and makes no express warranties, except as may be stated in its written agreement with and for its customers. SureCall shall not be held liable to anyone for any indirect, special or consequential damages due to omissions or errors. The information and specifications in this document are subject to change without notice.

© 2019. All Rights Reserved. All trademarks and registered trademarks are the property of their respective owners.

8.4 Compliance

WARNING: Changes or modifications not expressly approved by SureCall will void the user's authority to operate the equipment.

FCC Warning:

WARNING: This is NOT a CONSUMER device.

It is designed for installation by FCC LICENSEES and QUALIFIED INSTALLERS.

You MUST have an FCC LICENSE or the express consent of an FCC Licensee to operate this device.

Unauthorized use may result in significant forfeiture penalties, including penalties in excess of \$100,000 for each continuing violation.

IC Warning:

WARNING: This is NOT a CONSUMER device.

It is designed for installation by an installer approved by an ISED licensee. You MUST have an ISED LICENCE or the express consent of an ISED licensee to operate this device.

AVERTISSEMENT : Ce produit N'EST PAS un appareil de CONSOMMATION.

Il est conçu pour être installé par un installateur approuvé par un titulaire de licence d'ISDE. Pour utiliser cet appareil, vous DEVEZ détenir une LICENCE d'ISDE ou avoir obtenu le consentement exprès d'un titulaire de licence autorisé par ISDE.

^(*)
SIGNALBOOSTER
COM



<https://www.signalbooster.com> | 1-855-846-2654 | order@signalbooster.com