

CXL3 Cable Avoidance Tool

DXL3 Depth Measuring Cable Avoidance Tool

SGA3 Signal Generator





---

CXL3 Cable Avoidance Tool

DXL3 Depth Measuring Cable Avoidance Tool

SGA3 Signal Generator

---

Copyright © 2017 C.Scope International Ltd. All Rights Reserved.

C.Scope International Ltd make every effort to ensure that the information we provide about our products and their use is correct. We do not accept responsibility for injury, damage, or consequential loss arising from the use of our products. Local, national and international requirements and regulations must take preference.

# Contents

|                                   |       |  |       |
|-----------------------------------|-------|--|-------|
| <b>General Warnings</b>           | 3     | <b>Non-Metallic Pipe Tracing</b>             |       |
| <b>Features</b>                   |       | Sonde  | 28    |
| CXL3 Cable Avoidance Tool         | 4     | 33kHz General Purpose Sonde Batteries        | 29    |
| DXL3 Cable Avoidance Tool         | 4     | 33kHz Duct Sonde Batteries                   | 30    |
| SGA3 Signal Generator             | 5     | Tracing a Sonde                              | 31-32 |
| <b>Locator Operating Modes</b>    |       | Plastic Pipe Tracer and Flexible Tracer      | 33-34 |
| Power Mode                        | 6     | <b>Depth Measurement</b>                     |       |
| Radio Mode                        | 7     | Metallic Services                            | 35-36 |
| Generator Mode                    | 8     | Non-Metallic Pipes                           |       |
| <b>Using the Locator</b>          |       | - Sonde/Plastic Pipe Tracer /Flexible Tracer | 37    |
| Locator Batteries                 | 9     | <b>Function Checks</b>                       |       |
| Holding the Locator               | 10    | Locator Function Checks                      | 38    |
| Searching                         | 11    | Signal Generator Function Checks             | 39    |
| Pinpointing                       | 12    | Depth Measurement Function Checks            | 40    |
| Tracing                           | 13    | <b>General Symbols</b>                       | 41    |
| <b>Using the Signal Generator</b> | 14    | <b>Technical Specifications</b>              |       |
| Signal Generator Batteries        | 15    | CXL3 /DXL3 Cable Avoidance Tool              | 42    |
| Direct Connection                 | 16-17 | SGA3 Signal Generator                        | 43    |
| Street Lighting/Furniture         | 18    | <b>Maintenance</b>                           |       |
| Signal Clamp                      | 19    | Maintenance/Handling/Storage/Cleaning        | 44    |
| Signal Injector                   | 20    | <b>Support Services</b>                      |       |
| Searching                         | 21    | Training/ Servicing/ Repairs                 | 45    |
| Tracing                           | 22    |  |       |
| Induction                         | 23    |  |       |
| Searching                         | 24-25 |  |       |
| Multiple Services                 | 26    |  |       |
| Inductive Sweep                   | 27    |  |       |

## GENERAL WARNINGS



### **ALWAYS EXCAVATE WITH CARE**

C.Scope Locators detect services radiating a detectable signal. There may be some services that do not radiate a signal and cannot be located.

Do not use the equipment outside of the temperature range  $-10^{\circ}\text{C}$  to  $+50^{\circ}\text{C}$  ( $14^{\circ}\text{F}$  to  $122^{\circ}\text{F}$ ) as the batteries may cease to function adequately.

Geographical conditions such as hills and mountains may effectively screen signals and prevent a detectable Radio signal.

The Locators alone will not always locate every service. Use a Signal Generator wherever possible.

The Signal Generator leads **MUST NOT** be connected directly to a live service.

Beware of multiple services. The Locators will not always indicate services that are close together or one above the other.

Do not use the equipment in areas where hazardous gases may be present.

Check for underground services before using the Earth Stake.

Performance may be impaired by unusually strong electromagnetic fields.

Do not hold the Locator Loudspeaker close to the ear for extended periods.

---

**It is recommended that the operation of the Locator and Signal Generator is regularly checked (see pages 38-40).**

# CXL3 and DXL3 Cable Avoidance Tools

The CXL3 and DXL3 Cable Avoidance Tools can provide precise information about the position of buried services. The DXL3 also provides depth information. The combination of locating modes enables buried services to be detected quickly and reliably.

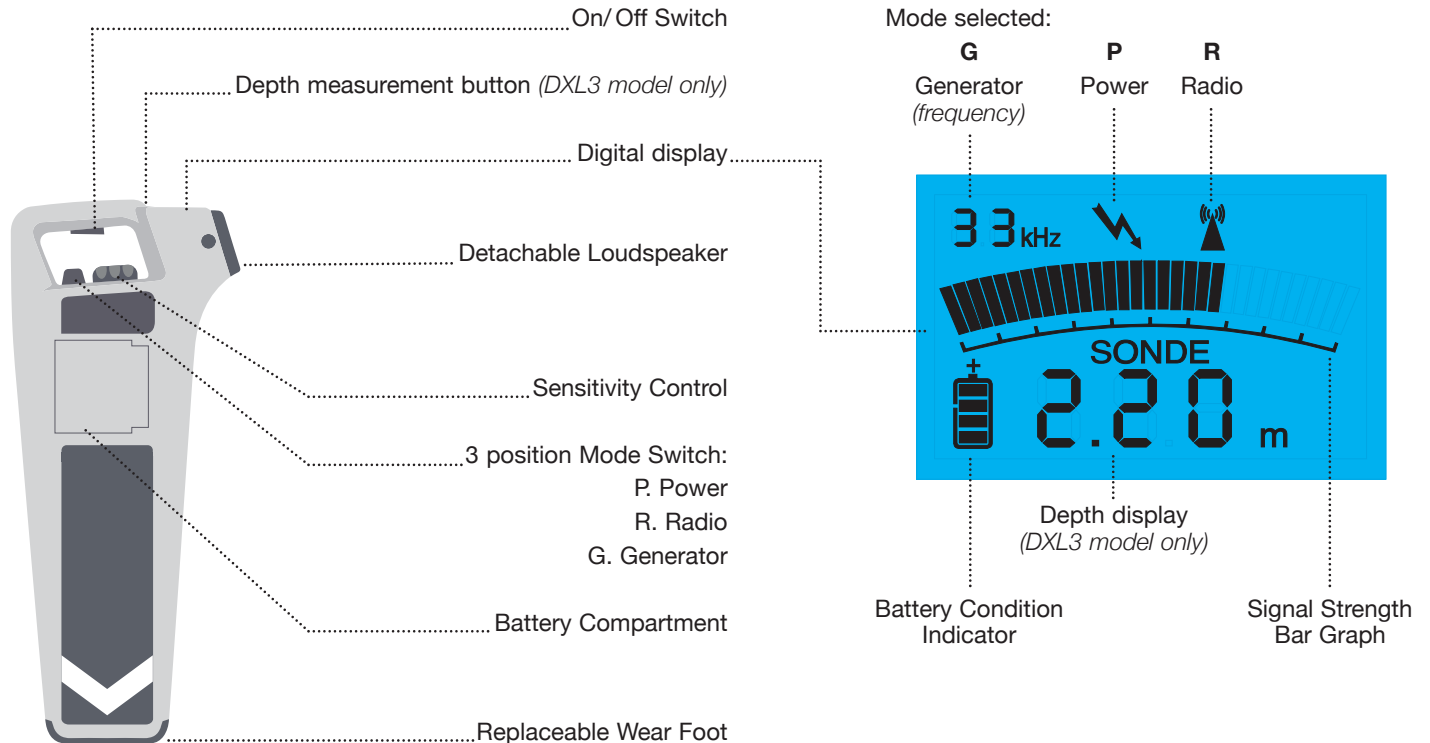

# SGA3 Signal Generator

A CXL3/DXL3 Cable Avoidance Tool should be used in conjunction with the SGA3 Signal Generator in order to fully optimise its capabilities. The SGA3 has the facility of high and low output power and can operate with a pulsed or continuous output signal.

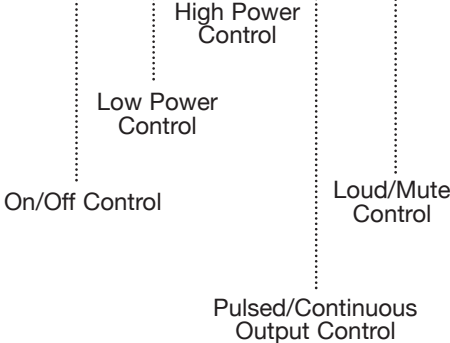
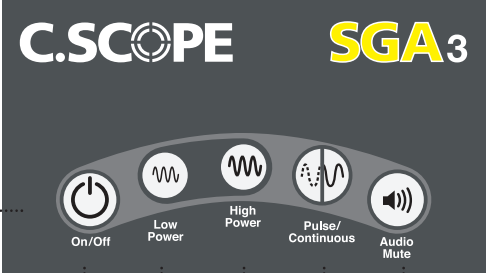
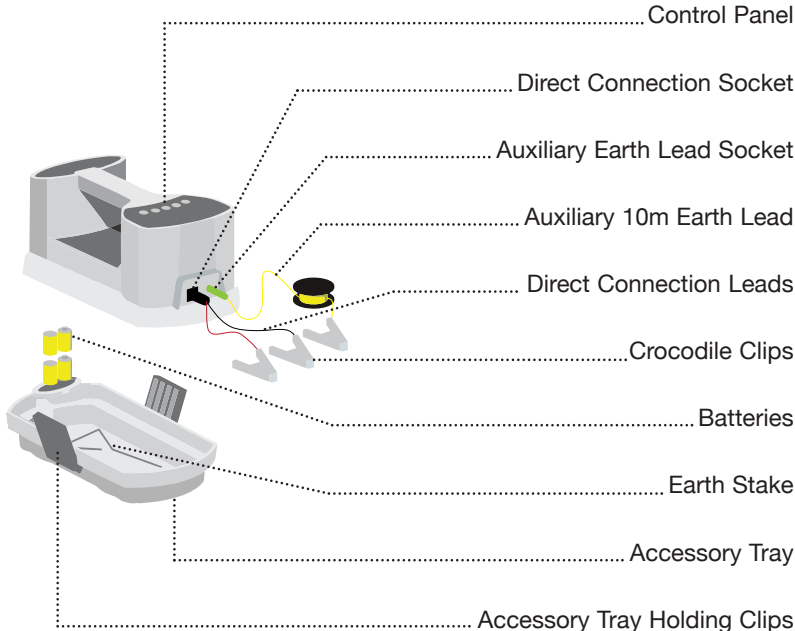

## Locator Operating Modes: Power Mode

In Power Mode the Locator detects power signals. These power signals are present on all current carrying electricity cables although not all are detectable. Power signals may also flow along other conductors such as metal gas and water pipes, telecom cables, metal fences and railway tracks.

### Limitations of Power Mode

Not all electricity cables can be found using the Power Mode. Here are the most important examples of electricity cables that may not be detectable in the Power Mode:

- Street lighting cables. When the lights are off, no current flows and so no power signal is created.
- Supplies to buildings or plant using very little or no electricity may not have a detectable power signal.
- Pot-ended or capped cables. These will never have any current flowing through them but are possibly still live.
- Disused or abandoned cables.
- A few high voltage electricity cables. These can be 'well balanced', electrically and therefore radiate little or no power signal.
- Direct Current cables (such as those found on railway systems). These do not create their own Power signals.
- Cables more than 3 metres (9'9") deep.



**NOTE** Locators can only detect services radiating a detectable electromagnetic signal. There may be some services that do not radiate these signals and cannot be located.  
**NOTE** The absence of a power signal does not mean the service is not live.



**WARNING** Generally these services should be detectable using the Radio or Generator Modes.

## Locator Operating Modes: Radio Mode

In Radio Mode, the Locator detects signals from various radio transmitters. These signals flow through the ground and will tend to follow the line of least resistance such as a buried metallic service. When this happens the service can often be detected by using the Locator in Radio Mode.

### Limitations of Radio Mode

- Not all services will be detectable in Radio Mode.
- A strong radio signal present on one service may be masking a weaker radio signal present on an adjacent service.
- It is not normally possible to determine what the service is in Radio Mode, only it's position.
- Radio signals do not favour one utility over another.
- The depth of the buried service cannot be judged by the strength of the radio signal alone.
- Normally it is only possible to detect radio signals present on services up to 2 metres (6'6") deep.
- A short service may not have enough signal to be detected.



**NOTE** Locators can only detect services radiating a detectable electromagnetic signal. There may be some services that do not radiate these signals and cannot be located.



**WARNING** Most buried metallic services not found in Radio Mode should be detectable by using Generator Mode with the Signal Generator.



## Locator Operating Modes: Generator Mode

In Generator Mode the Locator detects conductors radiating a signal applied by the Signal Generator or the signal radiated by a Sonde.

The Signal Generator provides a way of sending a known signal along buried metallic services which can then be detected using the Locator. By detecting this signal it is possible to locate, trace and identify the pipes or cables that may be carrying it.

There are TWO basic methods by which the Signal Generator signal can be applied to buried services:

- Direct Connection - The Signal Generator is attached directly to the service using either the Direct Connection Leads or one of the accessories available for use with the Signal Generator such as the Signal Clamp or Signal Injector.
- Induction - The Signal Generator can induce a signal onto a buried metallic service remotely from the surface without the need to physically connect to that service.

The Limitations of Generator Mode are covered in the 'Using the Signal Generator' section of this manual.

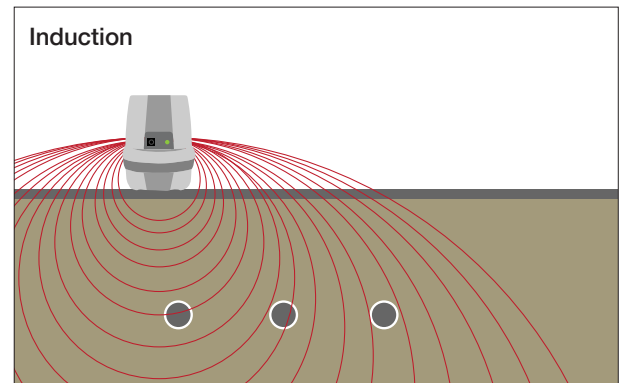
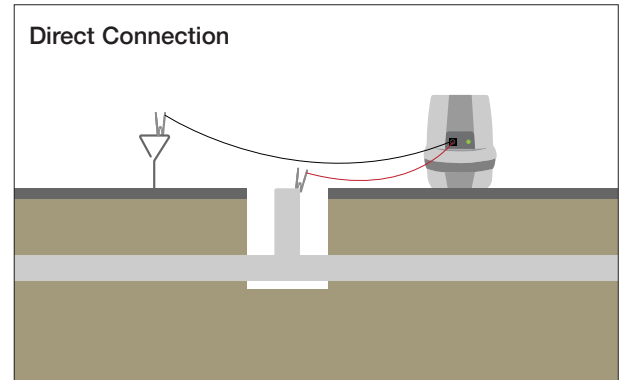

**WARNING** Locators can only detect services radiating a detectable electromagnetic signal. There may be some services that do not radiate these signals and cannot be located.

## Using the Locator: Batteries

C.Scope Locators can be powered by either eight standard alkaline or Nickel-Metal Hydride rechargeable (NiMH) AA (LR6) size batteries.

### Locator Battery Check

Switch the Locator on by pulling up on the On/Off trigger positioned on the underside of the handle. The Locator should emit a clear audible battery check tone for one second and the display should come on.

Check the battery level indicator in the bottom left hand corner of the display. If there is only one segment or no segments of the indicator filled in then the batteries will need to be replaced or recharged before locating work can begin.

### Changing Locator Batteries

Push the two clips back to release the Battery Compartment door. Remove ALL EIGHT used batteries and replace with new or recharged ones. Be careful to insert the new batteries the correct way round in the holder. Replace the holder in the Battery Compartment making sure that the two terminals on the holder make contact with the two terminals within the Battery Compartment. Close the Battery Compartment door securely.

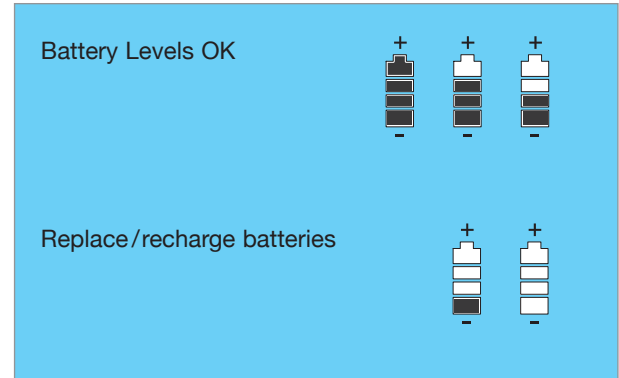

**NOTE** A spare battery pack can be carried inside the Battery Compartment.

**NOTE** Only use alkaline or Nickel-Metal Hydride rechargeable (NiMH) AA (LR6) size batteries.

**NOTE** Dispose of the used batteries safely in accordance with local regulations.



**WARNING** Do not change batteries in confined spaces where gas may be present.

**WARNING** Do not mix old and new or different types of batteries.

## Using the Locator: Holding the Locator

When in use the Locator should always be held upright. Never swing the Locator such that it moves away from the vertical.

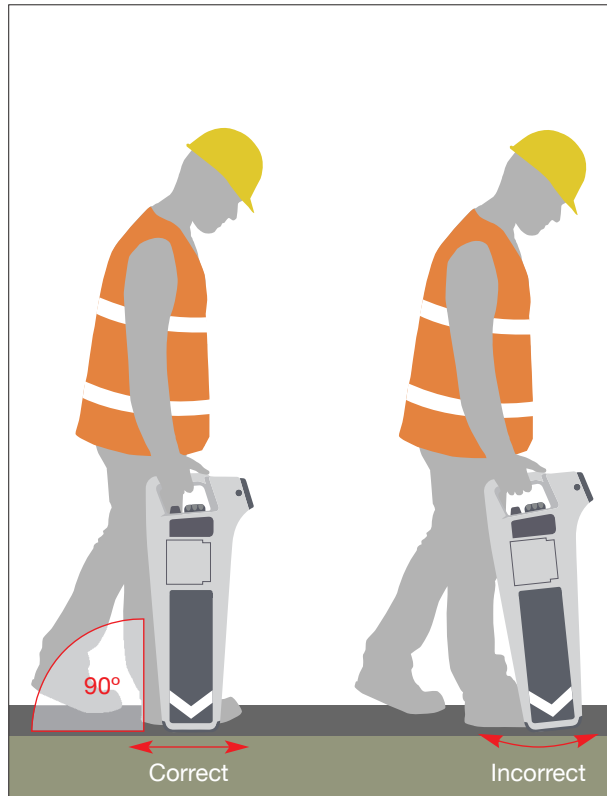

Your middle or little finger should be used to squeeze, and hold on, the On/Off trigger. Your index finger will then be free to adjust the Sensitivity Control.

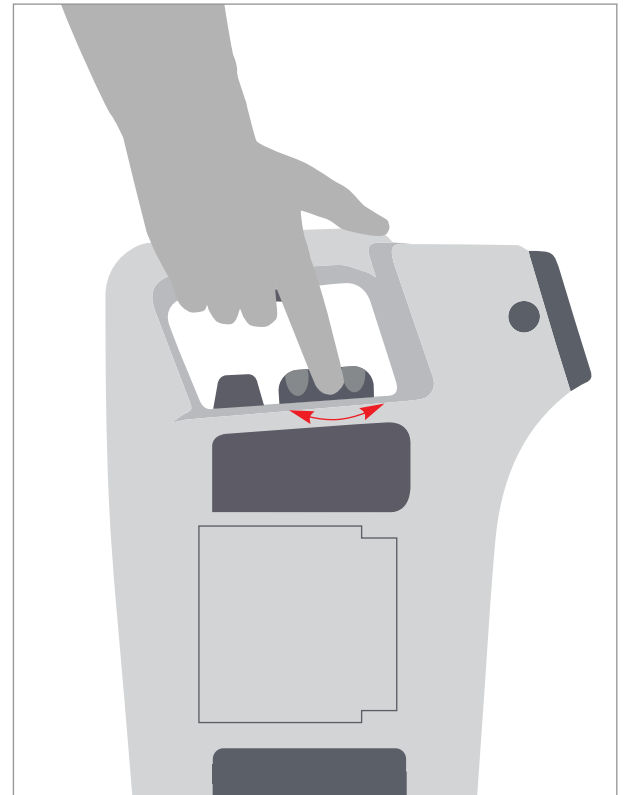

## Using the Locator: Searching

There are three stages to the locating process; searching, pinpointing and tracing.

1. Turn the Mode Switch to the appropriate mode.
2. Hold in the On/Off trigger. The Locator should emit the audible battery test tone and the digital display should come on. Check the battery level indicator to confirm the batteries are usable.
3. Rotate the Sensitivity Control fully clockwise to its maximum setting as indicated by the arrow on the control.
4. Carry out the search using a grid pattern as shown in the diagram. Walk slowly and keep the Locator upright at all times and stationary by your side.
5. As you approach the area in which there is a signal the Locator will emit an audible response and show a visual response on the display.
6. Keep walking until the audible and visual responses disappear.

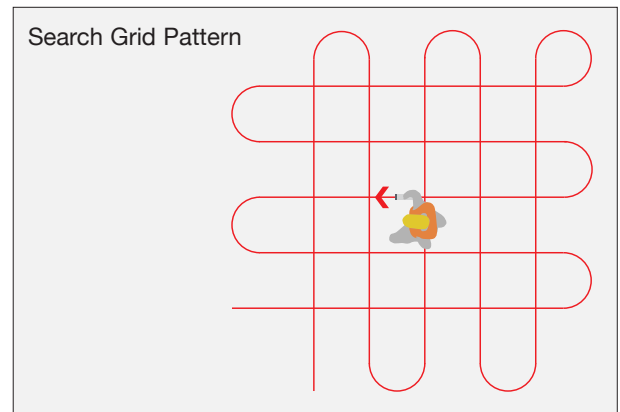

**NOTE** This search technique applies only to the Power and Radio Modes. See 'Using the Signal Generator' for the correct search pattern when using Generator Mode.

**NOTE** Sometimes the Locator will give an audible response and strong (full scale) visual response across the whole of the search area. In this case turn the sensitivity down slightly and repeat the search using the same grid pattern.

## Using the Locator: Pinpointing

Having found a signal the next step is to pinpoint the source. The closer the Locator is to the signal source the stronger the response.

### To Pinpoint a Signal

1. Keeping the Locator vertical, walk through the area of the signal response. If the visual response goes up off the scale then stop and reduce the sensitivity of the Locator slightly before continuing.
2. The width of the signal response will shrink as the sensitivity is reduced. Once it is reduced enough then a clear peak response will be seen on the display as the Locator traverses the service. The Locator is positioned directly above the buried service when the display is at its highest (peak) reading.
3. Carefully rotate the Locator over the peak reading until the visual response falls to a minimum. The Locator will now be roughly IN LINE with the direction of the buried service.

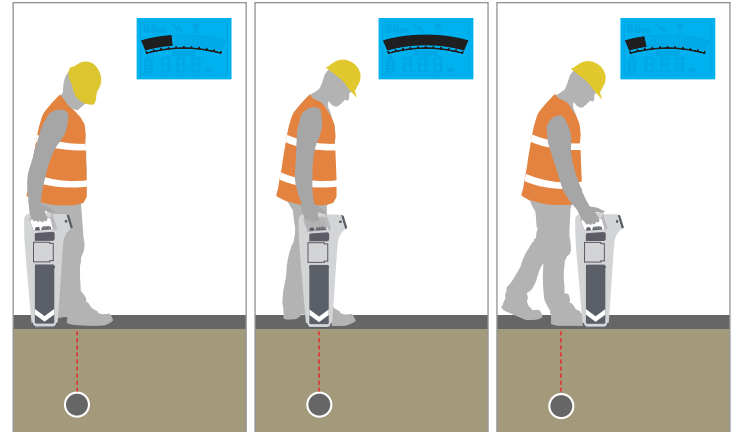

**NOTE** The presence of other signals in the immediate vicinity may result in the visual response not reducing to a minimum level when the Locator is rotated over the peak response.

4. Mark the position of the buried service.



**NOTE** The amount of sensitivity adjustment needed to pinpoint a service can vary depending on the mode being used, the signal strength and the service depth.

## Using the Locator: Tracing

Having pinpointed a service it should now be possible to trace its route.

1. Carefully follow the direction of the signal holding the Locator at right angles to the line of the signal. It is necessary to constantly 'slice' the Locator from side to side in order to be sure of still being over the peak signal response.
2. Stop and mark the position of the signal at regular intervals. As more marks are recorded the precise direction of the service will become more apparent.

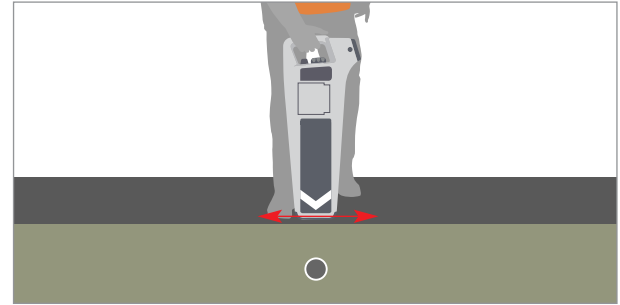

**NOTE** It may be necessary to readjust the sensitivity to maintain the optimum response.

**NOTE** After tracing, return to the original search grid to search for further buried services.



**WARNING** Never rush the tracing process. Small and unexpected changes in the service's route will be missed if care is not taken to follow the signal's path every step of the way.

### Lost Signals

This can be because of a curve, or bend in the route, change in depth of the service, a T connection or the end of the service.

### Finding Lost Signals

1. Locate in a circle at least 1 metre (3'3") around the point where the signal was lost. This should locate the service if it has simply changed direction sharply or T'd into another service.
2. If you find nothing then increase the sensitivity and repeat the circle. This should find the service if it has continued but at a greater depth.

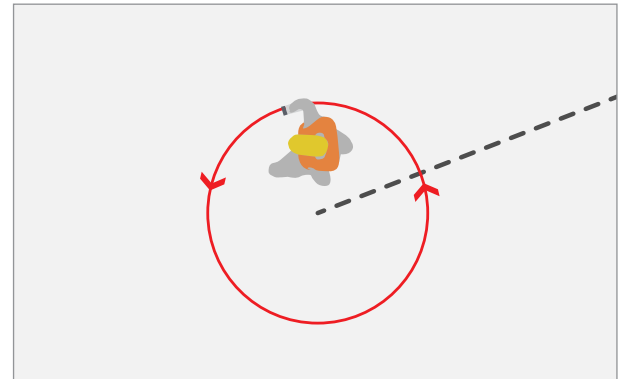

# Using the Signal Generator

Using the Locator in Power and Radio Modes will only allow you to locate and mark the position of buried services that are producing a Power signal or re-radiating a Radio signal.

Use of the Signal Generator should enable most, if not all, of the remaining buried metallic services to be detected and traced.

This section explains the various ways in which the Signal Generator can be used.

It also shows how to use those accessories that allow the Signal Generator to be directly connected to specific services.

**Direct Connection** - Physically connecting the Signal Generator to a service is the most effective way to transfer the signal onto that service and the best way to trace the route of that service.

**Signal Clamp** - The Signal Clamp is an accessory that allows the Signal Generator signal to be applied to a specific cable without having to make electrical contact with that cable. Although the Signal Clamp is not physically fixed to the cable we still consider it as a Connection method because it is using the Signal Generator in Connection Mode.

**Signal Injector** - The Signal Injector is an accessory that allows the Signal Generator signal to be safely applied to an electrical system via a conventional 3-pin power socket. This signal will then be detectable on the buried supply cable outside the building.

**Induction** - Induction is a method of applying a signal to a service to which there is no direct access.



**NOTE** The Locator should always be handled and operated according to the instructions shown in the 'Using the Locator' section unless specifically shown otherwise in this section.

## Using the Signal Generator: Batteries

C.Scope Signal Generators can be powered by either four standard alkaline or by four standard Nickel-Metal Hydride rechargeable (NiMH) D (LR20) size batteries.

### Signal Generator Battery Check

Switch the SGA3 Signal Generator on by pressing the On/Off Control.

The Signal Generator should emit a loud continuous tone.

If the batteries need replacing or recharging an interrupted tone will be heard.

During use, the Signal Generator will also warn the Locator user of low battery status by altering its normal continuous or pulsed signal output to a distinct interrupted signal output.

### Changing the Batteries

- Remove the Accessory Tray.
- Undo the two round knurled retaining screws situated on the underside of the Signal Generator holding the Battery Cover.
- Remove ALL FOUR used batteries and replace with new ones.
- Be careful to insert the new batteries the correct way round in the compartment as indicated on the case.
- Replace the Battery Cover being careful to not over tighten the retaining screws.
- Replace the Accessory Tray.



**NOTE** Only use alkaline or Nickel-Metal Hydride rechargeable (NiMH) D (LR20) size batteries.

**NOTE** Dispose of the used batteries safely in accordance with local regulations.



**WARNING** Do not change batteries in confined spaces where gas may be present.

**WARNING** Do not mix old and new or different types of batteries.



## Using the Signal Generator: Direct Connection



**WARNING** Never connect directly to electrical services.

**WARNING** You may need to seek permission from the service owners before connecting on to some buried services.

The Direct Connection Leads and Earth Stake that are supplied with the Signal Generator are used to apply a signal to any metal pipe at a suitable access point such as a valve, hydrant point, stop cock or exposed pipe length.

1. Plug the Direct Connection Leads into the Signal Generator Connection Socket.
2. Attach the red lead to the pipe at your point of access using the Crocodile Clip. Ensure that you have a secure and clean grip on the pipe with the Crocodile Clip.
3. Turn the Signal Generator on.
4. Place the Earth Stake in the ground (having first searched the area for buried cables with the Locator).

The ideal position for the Earth Stake is at right angles to the assumed line of the pipe and the full length of the Direct Connection Leads away from the pipe access point.

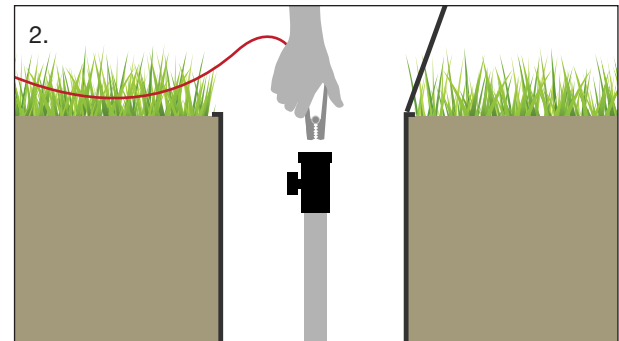
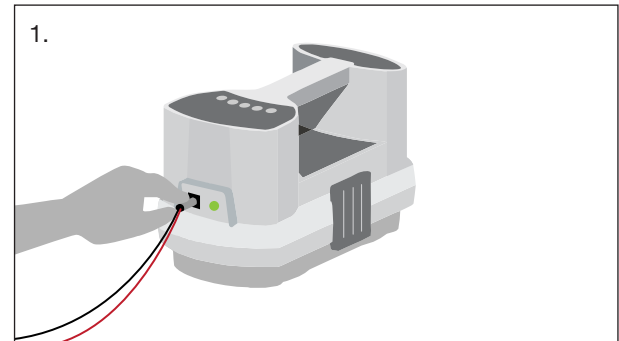

**NOTE** The type of metal that the pipe is constructed from or its use will have little effect on its traceability.

**NOTE** If it is not possible to get the Crocodile Clip to grip the pipe then use the Magnet on the back of the clip.

## Using the Signal Generator: Direct Connection

5. Connect the black Earth Lead to the Earth Stake (or an alternative earth point). If your earth point is too far away from the pipe access point for the black Earth Lead to reach then use the yellow 10 metre Auxiliary Earth Lead instead.

6. As the Earth Lead is connected to the Earth Stake the audible signal from the Signal Generator should change in pitch. The lower the pitch, then the better the signal will be on the metal pipe.

If there is no change in pitch it may be that some dirt, rust or paint on the pipe is preventing the Crocodile Clip or Magnet from making a good contact with the pipe. Alternatively it may be that your earth point is at fault. Change the position of the Earth Stake or use an alternative earth point.

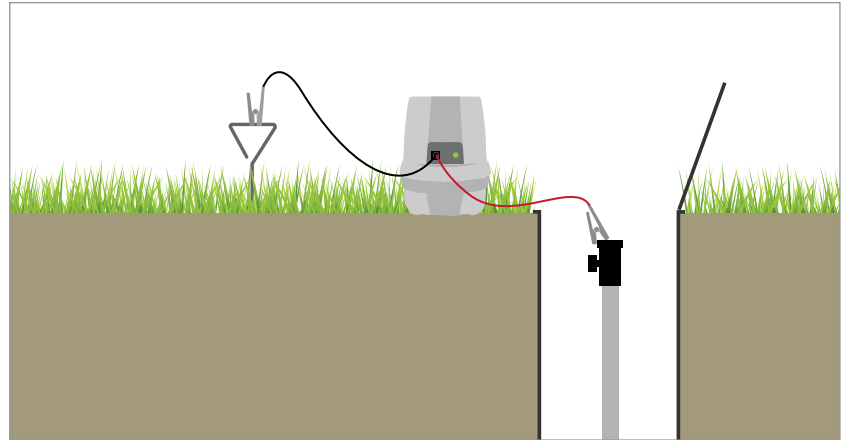

**NOTE** If it is not possible to use the Earth Stake use a nearby metal fence post, manhole cover or gully cover.

**NOTE** If the Earth Stake cannot be inserted into the ground then simply laying it flat on the ground can sometimes provide a successful earth connection (especially if the ground is wet).

**DO NOT** use something that may have another metallic service attached to it, such as a metal street lighting column.

**NOTE** If the Signal Generator pitch does not change then there is no signal being transferred onto the service.

## Using the Signal Generator: Direct Connection to street furniture

### Direct Connection to a Street Lighting Column or other street furniture

The best method to determine the position and route of street lighting, car park lighting cables or any other item of street furniture with a power supply is by using a Signal Generator and the pipe connection method.

Follow the same rules as for connecting the Signal Generator to a metal pipe except attach the red Direct Connection Lead to a metal part of the OUTSIDE of the lamp column/ street furniture.

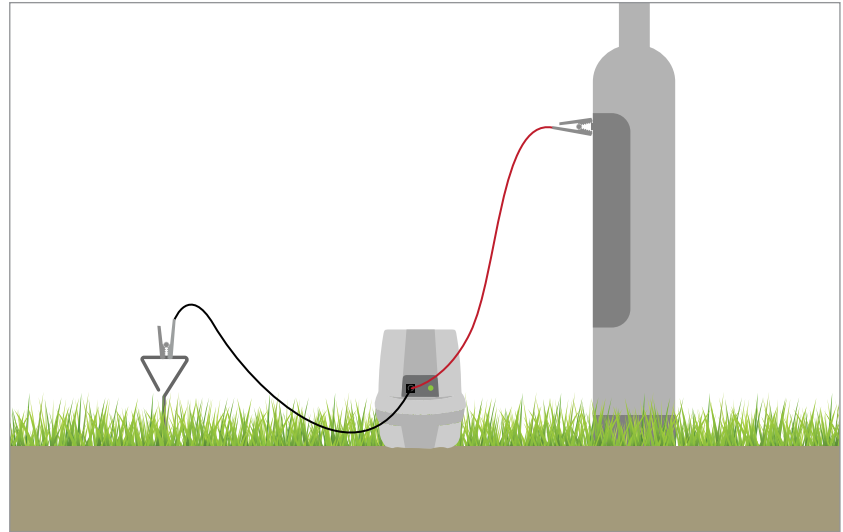

**WARNING** NEVER open the lamp column door to gain access to the cables, this is potentially dangerous and is not necessary.



**NOTE** Make sure that the Direct Connection Crocodile Clip or Magnet is not insulated from the metal of the column by paint.  
**NOTE** If the column is concrete attach the Crocodile Clip or Magnet to the metal surround of the access door.

## Using the Signal Generator: Signal Clamp

### Signal Clamp

1. Plug the Signal Clamp into the Connection Socket on the Signal Generator.
2. Turn the Signal Generator on.
3. Check that the jaws of the Signal Clamp are clean. Place the Signal Clamp AROUND the cable making sure that the jaws are able to fully close. The audible signal from the Signal Generator should drop in pitch indicating that the jaws have closed correctly.

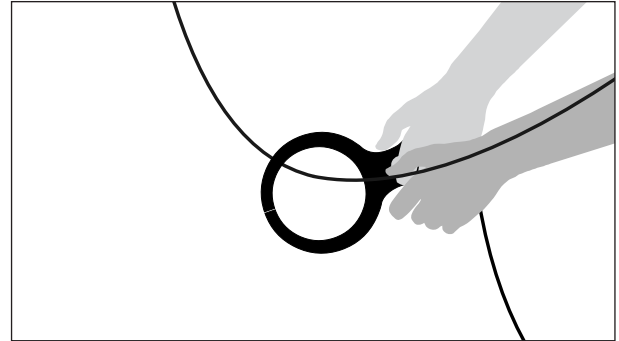

**WARNING** NEVER attempt to place the Signal Clamp around electricity cables that are deliberately suspended out of reach. They may be unsheathed or unprotected cables.



**NOTE** The Signal Clamp cannot apply a signal to a cable that is not earthed at both ends such as abandoned cables that have been cut off where they appear above ground or cables supplying unearthed equipment.

## Using the Signal Generator: Signal Injector

### Signal Injector

1. Plug the Signal Injector into the Connection Socket on the Signal Generator and an electric outlet.
2. Turn the Signal Generator on.
3. Turn the socket on. The audible tone from the Signal Generator will drop in pitch to indicate a successful connection.

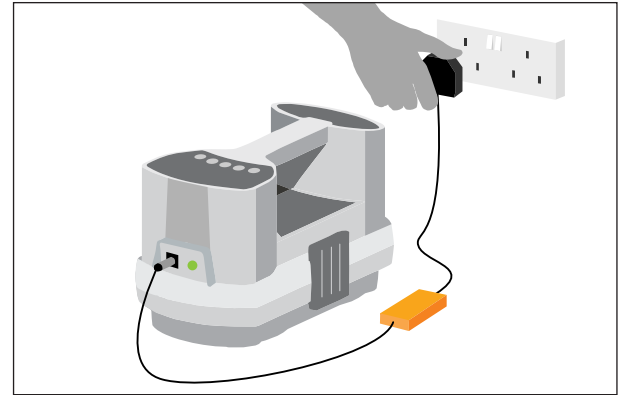

**NOTE** On two wire Protective Multiple Earth (PME) systems it may be necessary to also provide an external earth using the yellow 10 metre Auxiliary Earth Lead and Earth Stake.

**NOTE** Using the Signal Injector may cause the system protection to trip.

**NOTE** Always check with the owners that it is acceptable to interrupt the supply before connecting the Signal Injector.



**WARNING** DO NOT use the Signal Injector on systems with voltages in excess of 240 volts AC. Domestic systems will normally be below this voltage.

## Using the Signal Generator: Searching for the Direct Connected Signal

The search pattern used to find the Signal Generator signal when applied by a direct connection method (Direct Connection Leads, Signal Clamp or Signal Injector) is different to the normal search pattern used on Power or Radio Modes.

1. Move a few paces away from where the Signal Generator has been connected to the service. Turn the Mode Switch to Generator Mode. Hold the Locator so that the side of the Locator is facing towards the Signal Generator.
2. Adjust the sensitivity so that the Locator is just showing a visual response and just emitting an audible response.
3. If possible walk in a complete circle around the connection point trying to keep the same distance from this point at all times. When a signal is detected, 'pinpoint' that signal as shown in the 'Using the Locator' section.
4. Having pinpointed the first signal, do not readjust the Sensitivity Control but continue with the circle to see if any other signals are detected. If more signals are detected compare the strength of each signal by observing the bar display. The strongest signal will usually be coming from the service that the Signal Generator is connected to.

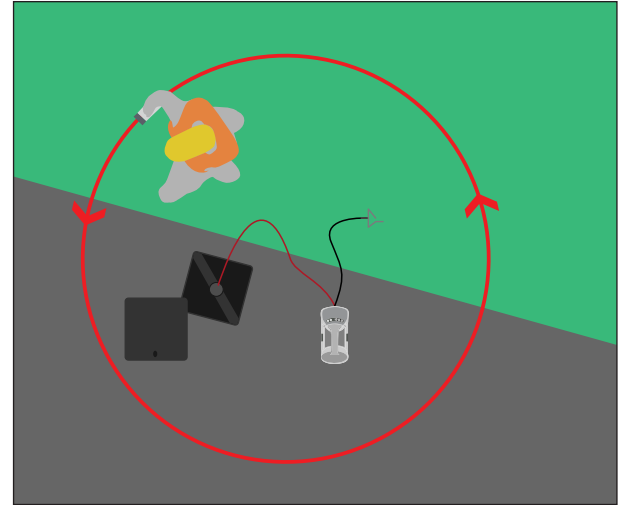

## Using the Signal Generator: Tracing the Direct Connected Signal

The tracing technique used to follow the Signal Generator signal when applied by a direct connection method (Direct Connection Leads, Signal Clamp or Signal Injector) is almost exactly the same as the normal tracing technique used on Power or Radio Modes except that the signal that the Locator is detecting will get weaker the further away from the Signal Generator that you go. It will be necessary to regularly adjust (increase) the Locator Sensitivity Control to compensate for this.

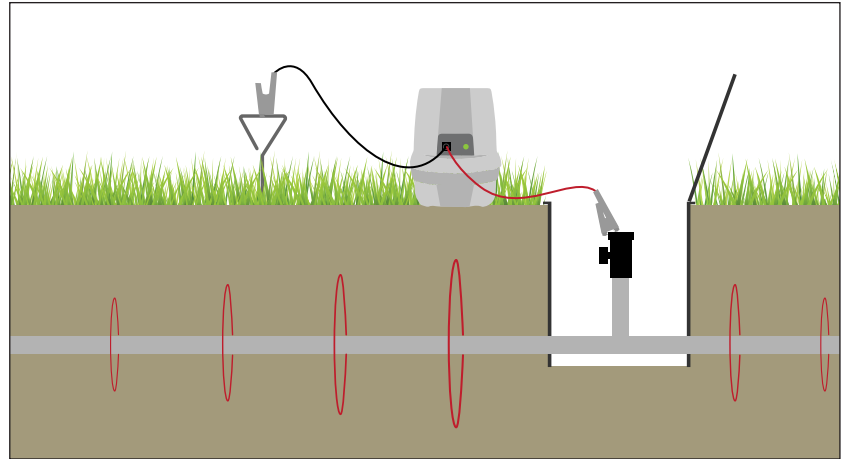

**NOTE** It is not possible to search for the signal above any leads connecting the Signal Generator to the service or above the Earth Lead connected to the Earth Stake.

## Using the Signal Generator: Induction

This is the standard method for inducing signals onto buried metallic services. It produces a strong signal directly below the Signal Generator but the signal strength drops off quite quickly either side of the Signal Generator.

1. Check that there are no accessories plugged into the Connection Socket. The Signal Generator switches automatically to Induction Mode when the socket is unused.
2. Place the Signal Generator upright on the ground where you suspect the services are buried. Make sure the Signal Generator is in line with the expected route of these services.
3. Turn the Signal Generator on and check that the batteries are OK.
4. The signal will be radiated into the ground immediately below and for approximately 3 metres (10') either side of the Signal Generator.

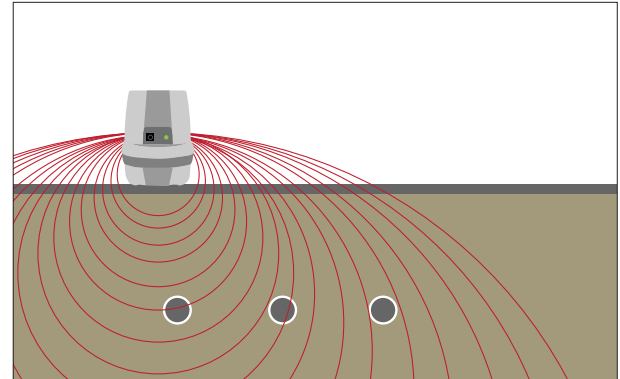

**NOTE** The closer the Signal Generator is to the position of the buried service then the stronger the signal will be on that service.

**NOTE** Only metallic services that are approximately in line with the Signal Generator orientation will be energised with a signal. Metallic services that are crossing the line of the Signal Generator will NOT be energised.



## Using the Signal Generator: Searching for an Induced Signal

The search pattern used to find the Signal Generator signal when applied by Induction Mode is slightly different to the search pattern used on other modes.

1. Move AT LEAST 10 metres (33') away from the Signal Generator position with your Locator. This is to avoid the Locator picking up the airborne signal rather than the signal induced onto the buried service.
2. Stand so that you are roughly in line with the end of the Signal Generator and hold the Locator so that the side of the Locator is facing towards the Signal Generator.
3. Select Generator Mode.
4. Adjust the sensitivity so that the Locator is JUST showing a visual response and emitting an audible response.

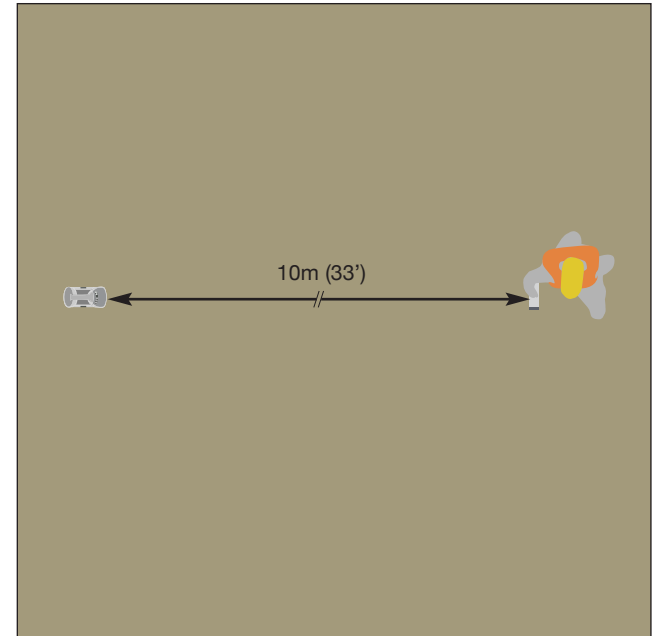

**NOTE** A Signal Generator will transmit a significant amount of signal into the air as well as into the ground.

**NOTE** Make sure you keep the Locator upright at all times to reduce the risk of picking up the airborne signal.

## Using the Signal Generator: Searching for an Induced Signal

5. Walk in a straight line across the end line of the Signal Generator. When a signal is detected 'pinpoint' that signal as shown in the 'Using the Locator' section.

If no signal is found move the Signal Generator 5 metres (16') and try again. Continue this procedure moving the Signal Generator in 5 metres (16') steps, following a grid pattern, until a signal can be found.

6. It may be possible to increase the strength of the induced signal on the buried service by improving the positioning of the Signal Generator. Once the buried service has been pinpointed, moving the position of the Signal Generator from side to side will give an increase or decrease in the Locator response. Remember, the closer the Signal Generator is to the position of the buried service then the stronger the signal will be on that service.

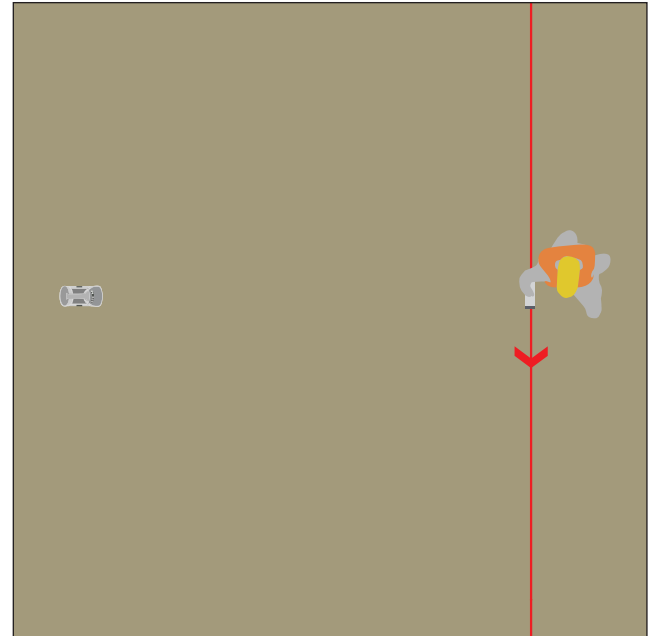

**NOTE** The Signal Generator signal that the Locator is detecting will get weaker the further away from the Signal Generator that you go. It will be necessary to regularly adjust (increase) the sensitivity to compensate for this.

## Using the Signal Generator: Induction: Multiple Services

It is important to check for the presence of adjacent services running close, or parallel, to the service that you have already located.

1. Check that there are no accessories plugged into the Connection Socket.
2. Turn the Signal Generator on and check that the batteries are OK.
3. Place the Signal Generator on the ground on one side over the previously located service. That service will not have a signal induced onto it.
4. Re-scan the area looking for another peak signal close to where the original signal was found. This operation should be repeated until you are satisfied that no further services can be located.

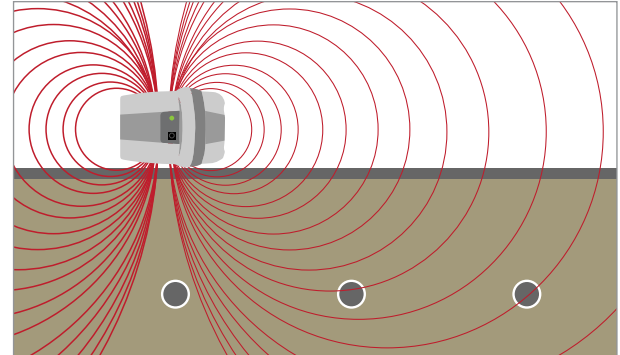

**NOTE** The signal will be radiated up to 3 metres (9'9") either side of the Signal Generator but NOT directly below when the Signal Generator is on its side.

**Limitations of Induction Method** - There are limitations concerning what can be achieved when using a Signal Generator on the Induction Mode compared to the Connected Mode. It is not normally possible to identify what the service is that has been detected with an induced signal. If the signal can be followed far enough, a visible feature such as a valve cover or cable pit cover may be found that can indicate the identity of the service.

Cables with a very small cross section may not have enough signal induced onto them to make them detectable. It is often not possible to apply an induced signal onto just ONE specific buried service, in order to trace it alone, when other services are positioned in a close proximity.



**NOTE** An induced signal cannot be applied to a buried service that lies beneath reinforced concrete. The reinforcing bars will re-radiate the induced signal masking any signal that has been induced onto the buried service below.

## Using the Signal Generator: Using an Inductive Sweep

If a large area needs to be searched for buried services then an 'Inductive Sweep' could be used. It is an ideal method for detecting the position of buried services as they cross the boundary of a large site.

An Inductive Sweep requires two people; one to operate the Locator and one to position the Signal Generator.

1. Stand about 10 metres (33') apart.
2. The first person holds the Signal Generator, switched to its lowest Output Power Level, close to the ground and 'end on' (see diagram) whilst the other holds the Locator switched to Generator Mode.
3. Adjust the sensitivity so that the Locator is just showing a visual response and emitting an audible response.
4. Together, slowly walk across the site, staying the same distance apart and being careful to keep in line with each other. When the Signal Generator gets close to a buried metallic service the signal will be induced onto it and you should see this in the increased response on the Locator.
5. Immediately tell your colleague to stop and place the Signal Generator on the ground at that point. Now you can pinpoint the service and trace out its route. Continue the sweep across the length and width of search area.

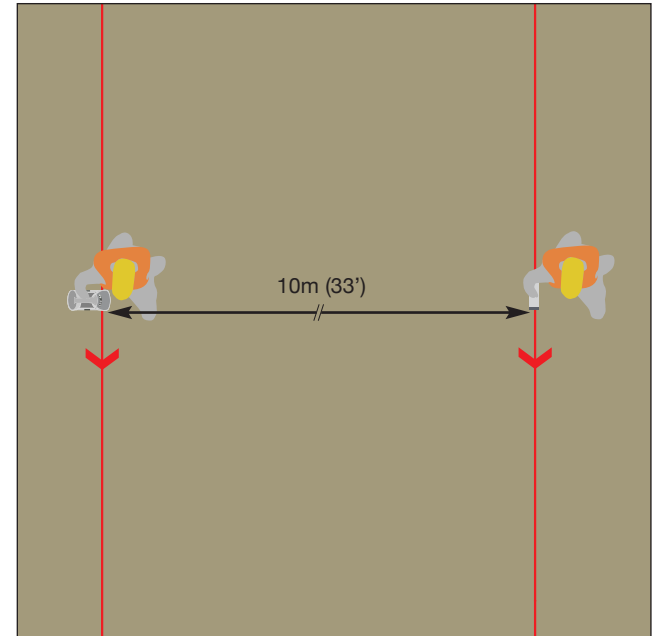

**NOTE** It is important to maintain the same distance and between the Locator and Signal Generator at all times.

**NOTE** Only metallic services that are approximately in line with the Signal Generator orientation will be energised with a signal. Metallic services that are crossing the line of the Signal Generator will NOT be energised.

# Non-Metallic Pipe Tracing using a Sonde

Non-metallic pipes such as sewers or drains, service ducts, plastic gas and water pipes are not electrically conductive and so will not be detectable using a Locator on Power or Radio Modes. It is also impossible to apply a detectable Signal Generator signal to the non-metallic pipe or, for that matter, to the water or gas within that pipe.

If access can be gained into these pipes then a C.Scope Sonde, Plastic Pipe Tracer or Flexible Tracer should make it possible to determine their position and route.

## Sondes

The C.Scope 33kHz General Purpose Sonde and Duct Sonde are small, battery powered, waterproof transmitters that can be inserted into a pipe, such as a sewer, drain or cable duct. The position of the Sonde (and therefore the location of the pipe) can be pinpointed by using the Locator switched to Generator Mode.

The Sonde is inserted into and then moved along the pipe to the point at which the pipe needs to be located. This is normally done by fitting the Sonde to drain rods. Alternatively, the Sonde can be attached to a continuous fibreglass duct rodder, jetter hose or camera inspection system.

- The 33kHz General Purpose Sonde can be used in pipes as small as 50mm (2") in diameter and up to 4.5 metres (14'9") deep.
- The 33kHz Duct Sonde can be used in pipes as small as 30mm (1.1") in diameter and up to 4.5 metres (14'9") deep.



**NOTE** Only the 33kHz General Purpose Sonde and 33kHz Duct Sonde can be used with the CXL3 and DXL3 Locators. Other frequency Sondes will not be detectable using the CXL3 and DXL3.

**NOTE** A 33kHz Sonde will NOT transmit a signal through a metal pipe.

# Non-Metallic Pipe Tracing using a Sonde: Batteries

## 33kHz General Purpose Sonde

The General Purpose Sonde is powered by a single standard alkaline or Nickel-Metal Hydride rechargeable (NiMH) AA (LR6) size battery.

1. To turn the Sonde on, separate the two halves of the Sonde casing. Insert a new battery into the battery compartment with the positive end down.
2. Screw the two halves of the Sonde together being careful not to over tighten them. The Sonde is now transmitting a signal.
3. To turn the Sonde off the battery must be removed or reversed.

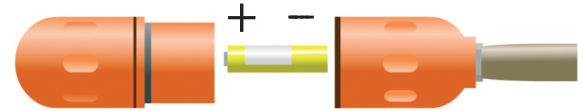

**NOTE** Only use an alkaline or Nickel-Metal Hydride rechargeable (NiMH) AA (LR6) size battery.

**NOTE** Dispose of the used battery safely in accordance with local regulations.

**NOTE** Always use a new battery in a Sonde if you expect to take a long time to trace the pipe or duct route.



**WARNING** The Locator must always be set to Generator Mode when using the Sonde.

# Non-Metallic Pipe Tracing using a Sonde: Batteries

## 33kHz Duct Sonde

The Duct Sonde is powered by a single AAA (LR03) size alkaline battery. Rechargeable batteries are not recommended for this product.

1. To turn the Duct Sonde on, use a large flat bladed screwdriver to unscrew the battery cover located within the hollow end of the Sonde casing. Insert a new battery into the battery compartment with the positive end down.
2. Replace the battery cover fully using the screwdriver to secure. The Duct Sonde is now transmitting a signal.
3. To turn the Sonde off the battery must be removed.



**NOTE** Only use an alkaline battery.

**NOTE** Dispose of the used battery safely in accordance with local regulations.

**NOTE** Always use a new battery in a Sonde if you expect to take a long time to trace the pipe or duct route.



**WARNING** The Locator must always be set to Generator Mode when using the Sonde.

# Non-Metallic Pipe Tracing using a Sonde: Tracing a Sonde

The technique used to determine the position of a Sonde is always the same irrespective of which Sonde is being used.

Before inserting the Sonde into the pipe it is best to set up the Locator so that the Sensitivity is correctly adjusted to suit the pipe depth. This is much easier to do when the Sonde is visible at the bottom of the manhole rather than already some distance up the pipe.

The blade of the Locator must be held **IN LINE** with the Sonde at all times.

1. Turn the Locator to Generator Mode. Check the Battery Level Indicator to confirm the Locator batteries are usable. Replace if necessary.

2. Keeping the blade of the Locator in line with the Sonde, move the Locator **backwards and forwards** over the length of the Sonde. Adjust the Sensitivity until a clear peak response is shown on the display as the Locator passes directly over the position of the Sonde.

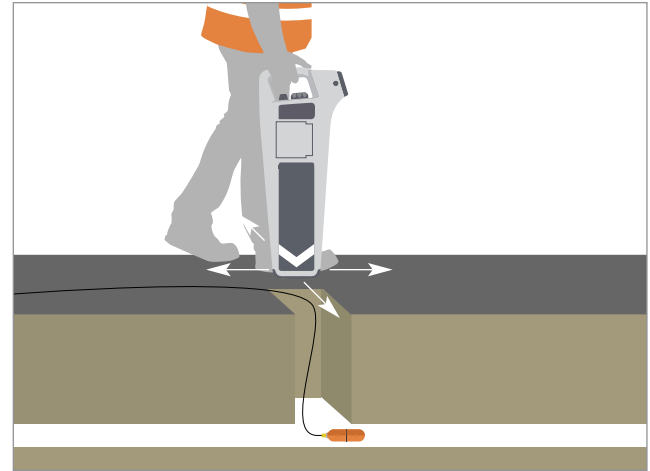

**NOTE** This is at 90 degrees to the way in which the Locator is held for most other locating tasks.

Still keeping the blade of the Locator in line with the Sonde, now move the Locator from **side to side** over the position of the Sonde. A similar peak response should be seen on the display as the Locator passes directly over the position of the Sonde. The Locator is now set up ready for tracing the Sonde.

3. Push the Sonde up the pipe.



## Non-Metallic Pipe Tracing using a Sonde: Tracing a Sonde

4. With the Locator turned on, walk from the pipe access point in the direction that the Sonde was pushed. A strong peak signal directly over the Sonde should be detected with two lesser 'ghost' signals found, one in front of and one behind the Sonde's true position. These ghost signals are always weaker than the main signal and should not be mistaken for the true Sonde signal.

5. Pinpoint the Sonde's exact position by moving the Locator first backwards and forwards and then from side to side to get the peak response on both occasions.

6. Push the Sonde further up the pipe and repeat the pinpointing process.

See Page 37 for depth measurement using a Sonde.

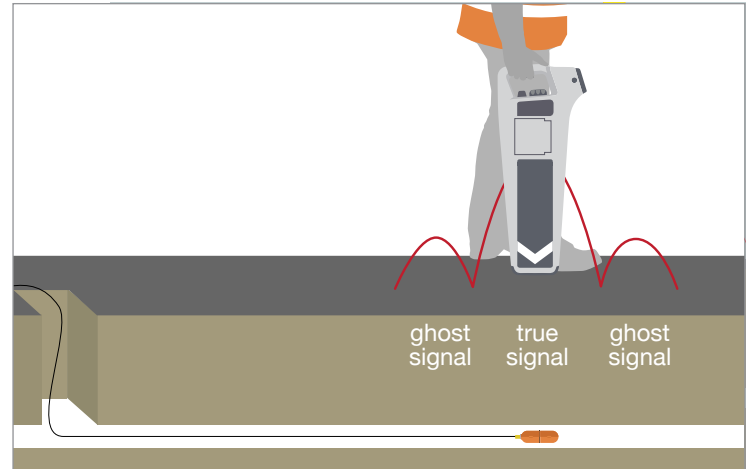

## Non-Metallic Pipe Tracing: Plastic Pipe Tracers/Flexible Tracer

The Plastic Pipe Tracers and Flexible Tracer can be used in small diameter non-metallic pipes that normal Sondes cannot fit into. Two methods of detecting and tracing can be used: line tracing and end tracing.

For **Line Tracing**, the Plastic Pipe Tracer needs to be inserted into the pipe before a signal from the Signal Generator is applied to the length of the Tracer. The slip-ring mechanism of the Flexible Tracer allows the Signal Generator to be connected before it is inserted into the pipe.

The Signal Generator signal is applied using the 'Direct Connection to a metal pipe' method. Connect the red Direct Connection Lead to the red terminal of the Plastic Pipe Tracer/ Flexible Tracer. Connect the black lead to the Earth Stake. Leave the other terminal of the Plastic Pipe Tracer/ Flexible Tracer unconnected.

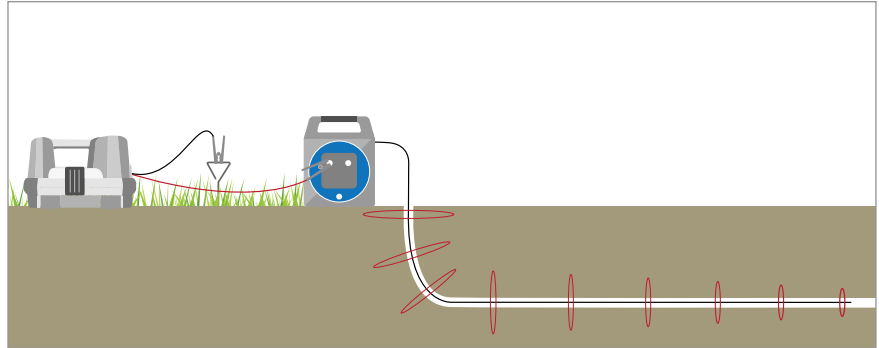

**WARNING** Authorisation may be required before using the Plastic Pipe Tracer/ Flexible Tracer on some pipes or ducts.



**NOTE** It is important that a change of pitch is heard when making the connections to ensure that there is a detectable signal present on the Tracer.

**NOTE** The Signal Generator signal is unlikely to travel the entire length of the Tracer within the pipe.

Never assume that you have located the end of the Tracer on Line Tracing Mode. Use End Tracing if required.

**NOTE** The Plastic Pipe Tracer and Flexible Tracer can be used inside a metal pipe or duct but the signal will transfer onto the pipe or duct itself.

# Non-Metallic Pipe Tracing: Plastic Pipe Tracers/Flexible Tracer

## End Tracing

The very tip of the Plastic Pipe Tracer/ Flexible Tracer can be energised with the signal from a Signal Generator. It is acting much like a Sonde and offers a very reliable way of pinpointing the position of the tip. Pipes and ducts up to 4 metres (13') deep can be traced.

The Signal Generator signal is applied by connecting the red Direct Connection Lead to the red terminal on the Tracer and the black Earth Lead to the other terminal. As the second connection is made a change of pitch should be heard from the Signal Generator signal indicating successful connection.

The tip of the Plastic Pipe Tracer/ Flexible Tracer is then pinpointed using the same technique as for Sonde tracing with the Locator blade always in line with the Tracer.

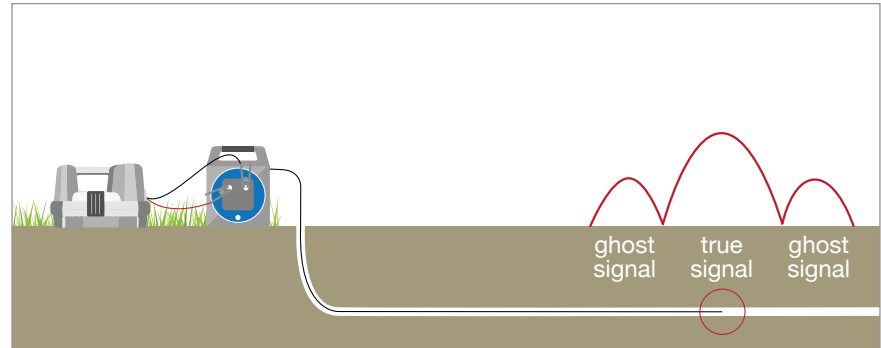

**WARNING** Authorisation may be required before using the Plastic Pipe Tracer/ Flexible Tracer on some services.



**NOTE** It is important that a change of pitch is heard when making the connections to ensure that there is a detectable signal present on the Tracer.

**NOTE** End Tracing is the ideal method to use to determine where the end of the pipe is but does not give the route of the pipe.

**NOTE** The Plastic Pipe Tracers and Flexible Tracer do not work on End Tracing mode when inside a metal pipe or duct.

## Depth Measurement of Metallic Services (DXL3 only)

The DXL3 can be used in conjunction with the Signal Generator, Sonde, Plastic Pipe Tracer or Flexible Tracer to indicate the depth of a buried service.

Depth cannot be measured on the Power or Radio Modes.



**WARNING** The depth indication **MUST NOT** be used to decide if mechanical digging over the buried service is appropriate.

**WARNING** If the following procedure for Depth Measurement is not followed then an inaccurate depth may be indicated. This is worse than having no depth information at all.

1. The Signal Generator must be set to 'Continuous' signal output, not 'Pulsed' output.
2. It is vital that the signal being measured is a good quality signal. This is best achieved by using the Signal Generator in Connected Mode rather than Induced Mode.
3. Set the Locator to Generator Mode and pinpoint the position of the buried service. Make sure the Locator is directly over the buried service and at right angles to it's route. Rest the Locator on the ground with the body vertical.

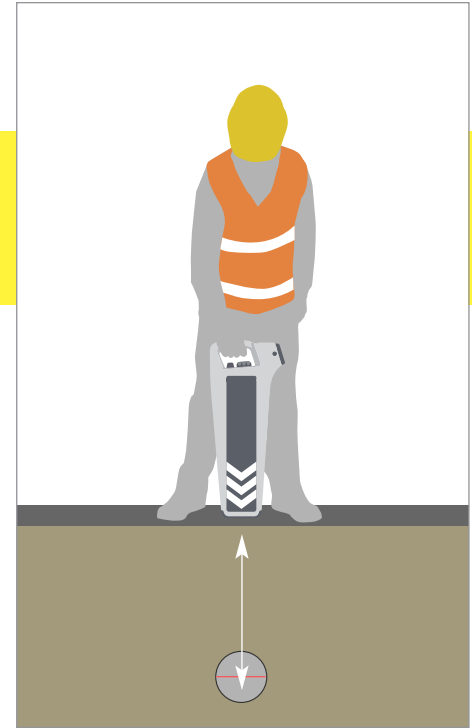

**WARNING** If the pinpointing of the service is inaccurate then the Depth Measurement will be inaccurate.



**NOTE** A poor quality signal is indicated by an unstable visual response on the Locator. Depth Measurement may be inaccurate in these circumstances.

## Depth Measurement of Metallic Services (DXL3 only)

4. Press and hold down the depth button. The depth will be shown on the display, measured in metres.

5. The depth can be verified by lifting up the Locator whilst keeping the depth button depressed. The depth indication should increase by the same amount that the Locator has been raised.

### Limitations of Depth Measurement

There are some situations where it is not possible to gain accurate depth information:

- A curve or bend in the route of the service.
- Close to where the service changes in depth.
- Near to a 'T' junction in the service.
- At the very end point of a service.
- At any point where the signal has coupled onto an adjacent service.
- Close to any large metallic objects such as metal fences or vehicles.
- Within 25 metres (82') of the position of the Signal Generator if used on Induction Mode.
- Under reinforced concrete.
- The signal is of poor quality.
- Too close to the Signal Generator or leads if used in Connected Mode.



### Depth Measurement: Error Readings of Metallic Services

The Locator may show the following error codes when attempting a Depth Measurement:

1. 000 - The metallic service is too shallow for the Locator to obtain an accurate depth, less than 0.2m (8 inches). It should be possible to calculate the depth by raising the Locator a set amount and then carrying out the Depth Measurement again.
2. 888 - The metallic service is too deep for the Locator to measure its depth or there is no signal at all present.
3. LO - The signal is not strong enough for the Locator to give a reliable depth measurement.
4. OL - Overload. The signal is too strong for the Locator to give a reliable depth measurement.



**NOTE** The depth shown will be to the centre of the service and is not the depth of cover. This is of greater significance on large diameter pipes. Reading is to the nearest 0.05m. Range is 0.2m to 3.0m (8" to 10').

## Depth Measurement of Non-Metallic Pipes using Sondes/Plastic Pipe Tracers/Flexible Tracer (DXL3 only)

**i** NOTE The following instructions apply equally to all Sondes, Plastic Pipe Tracers and the Flexible Tracer in End Tracing Mode.

1. Pinpoint the exact position of the Sonde or Plastic Pipe Tracer/Flexible Tracer tip. Take care to ensure that you are not over one of the two 'ghost' signals in front of and behind the true position.
2. Rest the DXL3 on the ground, keeping it vertical and IN LINE with the Sonde or Tracer tip.
3. **IMPORTANT. Push the depth button TWICE and hold on the second push, to select Sonde Depth Mode.** The word 'SONDE' will flash on the display and the depth will then be displayed (see picture). If the word 'SONDE' is not displayed then the depth reading will not be accurate.

**i** NOTE The depth shown is that of the Sonde and NOT of the pipe.

### Depth Measurement: Error Readings of Non-Metallic Pipes using Sondes/Plastic Pipe Tracers/Flexible Tracer

The Locator may show the following error codes when attempting a Depth Measurement to a Sonde or the tip of a Plastic Pipe Tracer or Flexible Tracer:

1. 000 - The Sonde/Plastic Pipe Tracer/ Flexible Tracer is too shallow for the Locator to obtain an accurate depth, less than 0.8m (31 inches). It should be possible to calculate the depth by raising the Locator a set amount and then carrying out the Depth Measurement again.
2. 888 - The Sonde/Plastic Pipe Tracer/ Flexible Tracer is too deep for the Locator to measure its depth or there is no signal at all present.
3. LO - The signal from the Sonde/Plastic Pipe Tracer/ Flexible Tracer is not strong enough for the Locator to give a reliable depth measurement.
4. OL - Overload. The signal from the Sonde/Plastic Pipe Tracer/ Flexible Tracer is too strong for the Locator to give a reliable depth measurement.



# CXL3 and DXL3 Locator Function Checks

It is recommended the following checks are carried out regularly:

## Battery Condition

Check the Locator battery condition by depressing the On/Off Switch beneath the handle. The display will show at least two solid segments if the batteries are OK. Ensure power on tone is heard.

## Power Mode

Select Power Mode. Set sensitivity fully clockwise and point the base of the Locator at a fluorescent light from a distance of 1 metre (3'). Switch the light on. A loud tone should be heard and the display should read greater than 50% full scale. Reducing the sensitivity should cause the displayed reading to reduce and the tone to cut out.

## Radio Mode

Select Radio Mode. Set the sensitivity fully clockwise and, from a distance of less than 0.25 metres (10"), point the base of the Locator at a metal conductor of length greater than 100 metres (330'), for example a metal pipe or cable. A warbling tone should be heard. The display should read greater than 50% full scale.

## Generator Mode

Locate an outdoor test area that is free from overhead and underground cables and metal pipes. The area should also not be near fences, steel framed buildings, or on reinforced concrete. Place the Signal Generator on the ground and switch on - a tone should be heard. Set to Continuous and ensure lowest Output Power is selected.

With the Locator in the orientation shown, select Generator Mode. Rotate sensitivity fully clockwise. The results in the table below should be indicated. Reducing the sensitivity should cause the displayed reading to reduce and the tone to cut out.

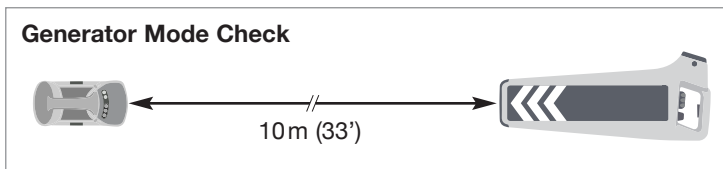

| DISTANCE  | MODE      | AUDIO                 | METER                |
|-----------|-----------|-----------------------|----------------------|
| 6m (20')  | Generator | Present               | Full scale           |
| 12m (40') | Generator | Less than at 6m (20') | Less than Full scale |



**NOTE** These Function Checks are approximate only. If a deterioration in performance is suspected for any reason, the equipment should not be used. It should be returned to C.Scope or a C.Scope Authorised Service Centre for more thorough investigation.

# SGA3 Signal Generator Function Checks

## **Battery Condition**

Turn the Signal Generator on. Good batteries will be indicated by a loud, clear audio tone. Bad batteries give an interrupted audio tone.

## **Induced Mode**

This can only be checked in conjunction with a Locator as described on the previous page. If the unit does not meet the performance expected, repeat the test with another Locator to determine whether the Signal Generator is at fault.

## **Connected Mode**

Set the minimum Output Power Level, insert the Direct Connection Lead and the 10 metre Auxiliary Earth Lead and then connect the red lead Crocodile Clip to the Auxiliary Earth Lead Crocodile Clip. The pitch should change to a low tone.

The leads should be arranged to create an open loop on the ground of approximately 1 metre (3') in diameter. Check that a signal can be detected by the Locator in Generator Mode when pointed closely at the loop.



**NOTE** These Function Checks are approximate only. If a deterioration in performance is suspected for any reason, the equipment should not be used. It should be returned to C.Scope or a C.Scope Authorised Service Centre for more thorough investigation.



# Depth Measurement Locator Function Checks (DXL3 only)

## Depth Measurement

An area clear of services and metal structures should be chosen (beware of reinforced concrete car parks). A search with the DXL3 in all modes will help confirm the absence of other services. An insulated cable or wire (not supplied) over 20 metres (70') is laid out on the ground and the far end connected to a ground stake and earthed. The near end is connected to the red Direct Connection Lead.

The black Earth Lead should be laid at right angles to the 20 metre (70') cable and earthed at the far end with the Earth Stake. The plug should be inserted in the Direct Connection Socket of the Signal Generator.

The Signal Generator is turned on to the lowest Output Power Level and Continuous Mode. The Locator should then be held vertically above the longer cable, approximately midway along it and the depth can then be measured. It is best to make a few readings at different depths.

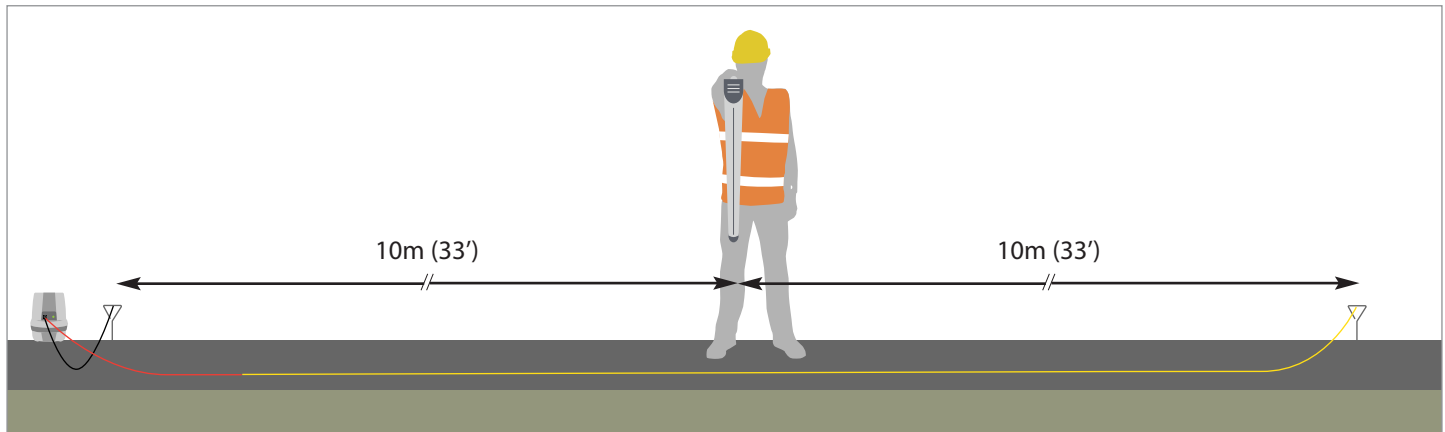

**NOTE** These Function Checks are approximate only. If a deterioration in performance is suspected for any reason, the equipment should not be used. It should be returned to C.Scope or a C.Scope Authorised Service Centre for more thorough investigation.

# General Symbols

**Warning** - Refer to manual.



---

Waste electrical products should not be disposed of with household waste. Please recycle where facilities exist. Check with your local authority or retailer for recycling advice.  
(In the UK visit [www.recycle-more.co.uk](http://www.recycle-more.co.uk))



---

Conforms to EC safety requirements.



---

Tested to harmonised standards.  
Some restrictions on use in some EC countries.  
Contact Local Authorities.



---

Double Insulated.



# CXL3 and DXL3 Locators Technical Specifications

|                              |   |
|------------------------------|---|
| Controls                     | On/Off Switch: Spring loaded trigger switch under handle<br>Function Select Switch (Three position): P – Power Mode; R – Radio Mode; G - Generator Mode<br>Sensitivity Control<br>Depth Button: Push button for live display of depth - DXL3 only   |
| Audio Indication             | Removable and user replaceable loudspeaker module   |
| Visual Indication            | Multi-segment Liquid Crystal Display indicating:<br>Signal Strength; Mode selected; Battery Condition;<br>Depth Measurement (in Generator Mode) - DXL3 only   |
| Construction                 | Case moulded from high impact plastic. Designed to withstand 1m (3'3") drop onto a hard surface   |
| Weight (including batteries) | 2.9kg (6 pounds 6 ounces)   |
| Dimensions                   | 720mm x 270mm x 63mm (28.3" x 10.6" x 2.4")   |
| Performance                  | Locate Accuracy: better than 10% of depth<br>Depth Accuracy: $\pm 5\%$ @ 1m (3'3") - DXL3 only<br>Depth Measurement Range: Line 0.2m to 3m (8" to 10')<br>Depth Resolution: Line 0.05m<br>Depth Measurement Range: Sonde 0.85m to 4.5m (2'9" to 15') - depending on Sonde type<br>Depth Resolution: Sonde 0.15m |
| Battery Type                 | Internal 8 x 'AA' (LR6) cells (either alkaline non-rechargeable or NiMH rechargeable)   |
| Battery Life                 | 40 hours intermittent use at 20°C (68°F) using alkaline cells   |
| IP Rating                    | 65  |

## Note

Performance figures stated can be affected by site parameters such as ground conditions, temperature, and strong electromagnetic fields.

Specification may be subject to change.

All C.Scope Locators are in compliance with the essential requirements and other relevant provisions of Council Directive 2014/30/EU.

Compliance has been demonstrated by testing representative samples to the relevant harmonised standards.

All C.Scope Locators comply with the RoHS directive, 2011/65/EU.

# SGA3 Signal Generator Technical Specifications

|  |  |
|--|--|
| Controls   | All operation is by push button control as follows:<br>On/Off<br>Power Level: 2 available power levels via High and Low Power buttons<br>Pulse/Continuous Output: toggles between pulse or continuous output using one push button<br>Audio/Mute: toggles between high or low level audio output using one push button |
| Audio Indications  | Audio Feedback on button push<br>Audio pitch drops with increasing load current in Connected Mode<br>Audio pitch changes with power level in Induced Mode<br>Audio output pulses to indicate Pulsed Mode<br>Low battery indicated by interrupted Audio and output signal   |
| Output   | Induced = 32,768Hz<br>Connected = 32,768Hz<br>Carrier Pulse Frequency: 7.5Hz (pulsed mode)<br>Audio Pulse frequency: 3.75Hz (pulsed mode)  |
| Connected Mode   | Connection Mode automatically selected when lead is plugged into socket<br>Maximum Output Voltage (open circuit): 20V rms<br>Maximum Output Current (short circuit): 18mA rms<br>Maximum Power: 320mW into 1000Ω load  |
| Construction   | Case moulded from high impact plastic. Designed to withstand 1m (3'3") drop onto a hard surface<br>Incorporates clip on Accessory storage compartment  |
| Weight (including batteries, Connection Leads and Earth Stake) | 3.4kg (7 pounds 7 ounces)  |
| Dimensions (with Accessory storage compartment)                | 360mm x 180mm x 230mm (14.1" x 7" x 9")  |
| Battery Type   | Internal 4 x 'D' (LR20) cells (either alkaline non-rechargeable or NiMH rechargeable)  |
| Battery Life   | up to 40 hours intermittent use at 20°C (68°F) using alkaline cells  |

## Note

Performance figures stated can be affected by site parameters such as ground conditions, temperature, and strong electromagnetic fields.

Specification may be subject to change.

All C.Scope Signal Generators are in compliance with the essential requirements and other relevant provisions of Council Directive 2014/53/EU.

Compliance has been demonstrated by testing representative samples to the harmonised standards EN300-330 and EN301-489.

The essential radio test suites have been carried out and the equipment is in conformity with all applicable directives.

All C.Scope Signal Generators comply with the RoHS directive, 2011/65/EU.

# Maintenance

## Handling

C.Scope Locators and Signal Generators are rugged instruments designed for the rigours of every day use. However, to ensure that the specified accuracy is maintained, it is essential to treat the instruments with care by avoiding shocks, vibration and excesses of temperature.

The construction of C.Scope Locators and Signal Generators incorporate weather proof seals, however, they are not guaranteed to prevent water ingress if the equipment is immersed.

## Cleaning

The equipment can be cleaned with a sponge dampened with warm water. A mild soap may be used if required. The use of solvents should be avoided.

Do not allow moisture in the battery compartments or near the connectors.

## Storage

The equipment should be stored in a clean and dry environment. The temperature should not exceed the range -10°C to +50°C (14°F to 122°F). If stored for long periods the batteries should be removed.

## Support Services: Training/ Servicing/ Repairs

### **Training**

This Instruction Manual is comprehensive but cannot fully replace expert tuition. Excellent training is available directly from C.Scope and via authorised C.Scope agents, cost effectively, at your chosen location. C.Scope recommend operators are trained before using the equipment.

### **Servicing**

It is strongly recommended that the CXL3 and DXL3 Locators and the SGA3 Signal Generator are serviced at least once a year by an Authorised Service Centre to ensure performance to specification. Contact your supplier for information.

### **Repairs**

Before returning equipment suspected of being faulty, please check the machine carefully with a fresh set of batteries. Check the battery connections and rotate the batteries in the holder. Refer to the section in this manual on Function Checks and if possible substitute known good equipment as a confirmation. If the problem persists then contact the company from whom you purchased the equipment, or contact C.Scope indicating the nature of the fault. Advice on the best course of action can then be given.



**C.Scope International Ltd**

Kingsnorth Technology Park  
Wotton Road  
Ashford  
Kent TN23 6LN  
United Kingdom

Telephone. +44(0)1233 629181

Fax. +44(0)1233 645897

email. [info@cscope.co.uk](mailto:info@cscope.co.uk)

website. [www.cscopelocators.com](http://www.cscopelocators.com)