

# Technical Data Sheet

# WEISS™

## FV107 Elite

Inline Extractor fan with timer and 150mm Ducting

### Dimensions

Cut-out size for inlet fascia	155mm
Cut out size for outlet vent	155mm

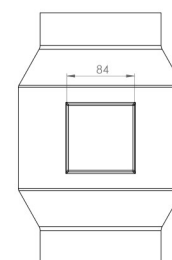
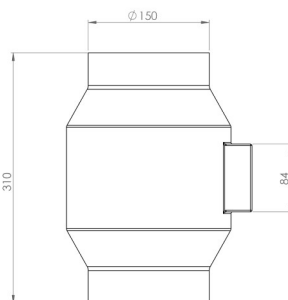
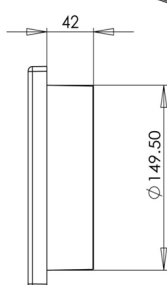
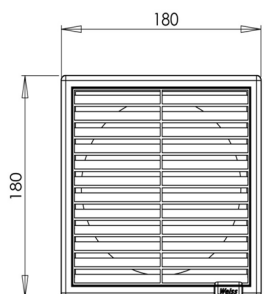
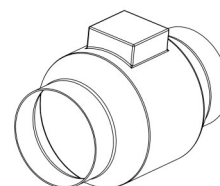
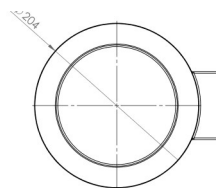
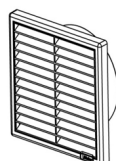
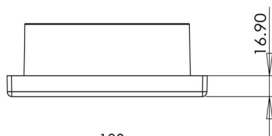
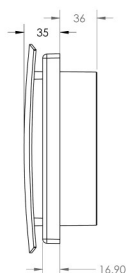
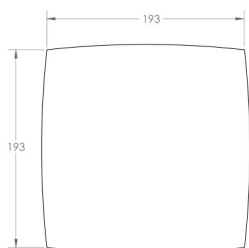
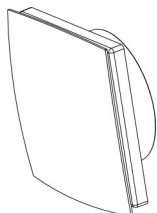
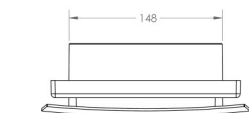

### Specifications

Weight	2.5kg
Colour of front fascia	White
Housing material	ABS

### Approval

AS/NZS 603350.2.80:2004 Amdt 1.2009  
AS/NZS 60335.1.2011 incl Amdt.1.2012

### Features

- Easy to install
- 6 metres of 150mm ducting supplied
- Quiet powerful 2 speed fan motor
- Allows moisture to be removed to the outside of your home
- All parts are included
- 3 year extended warranty

# Technical Data Sheet

## Product Use

The FV107 Elite is used for the extraction of mist and steam

Typical applications:

- Bathrooms
- Toilets
- Laundries

## Environmental Conditions

Operation	to IEC 721-3-3
Climatic conditions	class 3K5
Temperature	0...+50°C
Humidity	<95% r.h.

## Standards

Test standards	AS/NZS 603350.2.80: 2004 Amdts 1 and 1:2011 Amdt.1
Test Report no EMC Compliance	NTEK 2014NT1106758W This is a Level One product with an C frame motor that has a very low risk of causing EMC Interference

## General

Free Air Fan Performance	530m <sup>3</sup> / hr 147.2L/sec
Installed decibel rating	44DB

## Ordering

When ordering please give name and type,  
Reference FV107 Elite  
Barcode

## Technical Data

Power Supply	230 VAC
Power consumption	max. 0.22Amps
Supply Line fusing	max. 10A
For solid wires	2 x 1.5mm <sup>2</sup>
Motor	230-240VAC 50Hz 0.22Amp
Motor insulation class	B1
Total motor wattage	54 Watts
Motor protection	Thermally protected
Total product wattage	54 watts

# Technical Data Sheet

## HSFA175

# WEISS™

Run-on Timer

Hangsell

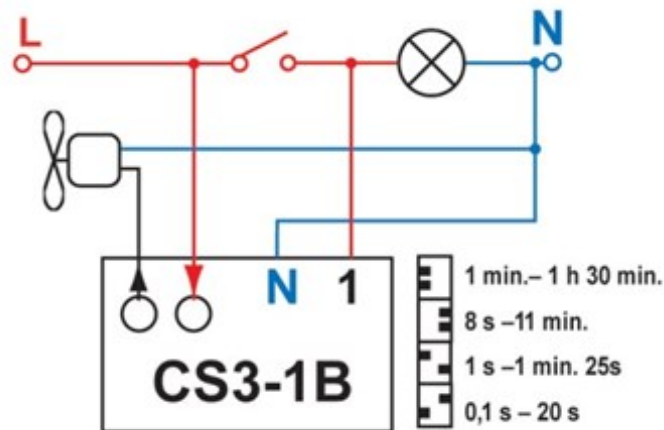

Activates the fan "DELAY" start (1s to 5 min) after switching the lighting on and deactivates it at a pre-set time (1s to 90 min. "TIMING") after switching the lighting off.

### Specifications

N/A

### Approval

740-145/01

### Features

Fully Adjustable Timer

- Easy to install
- Start timer adjustable
- Run timer adjustable
- 1 year warranty

