

Glass Panel Silicone Detail

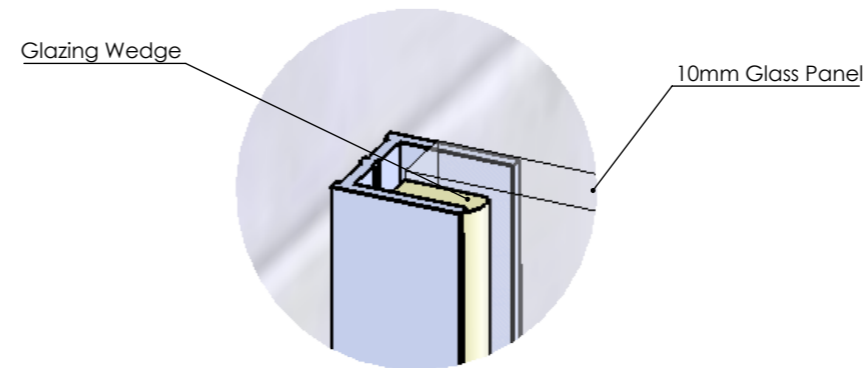

DETAIL A  
SCALE 1 : 1

I \_\_\_\_\_ confirm that all dimensions are correct.

Signature: \_\_\_\_\_



SH4412-12  
DIMENSION SHEET  
DIMENSIONS: 1200

**S E R E N O  
W A L K I N  
I N S T A L L A T I O N  
I N S T R U C T I O N S**

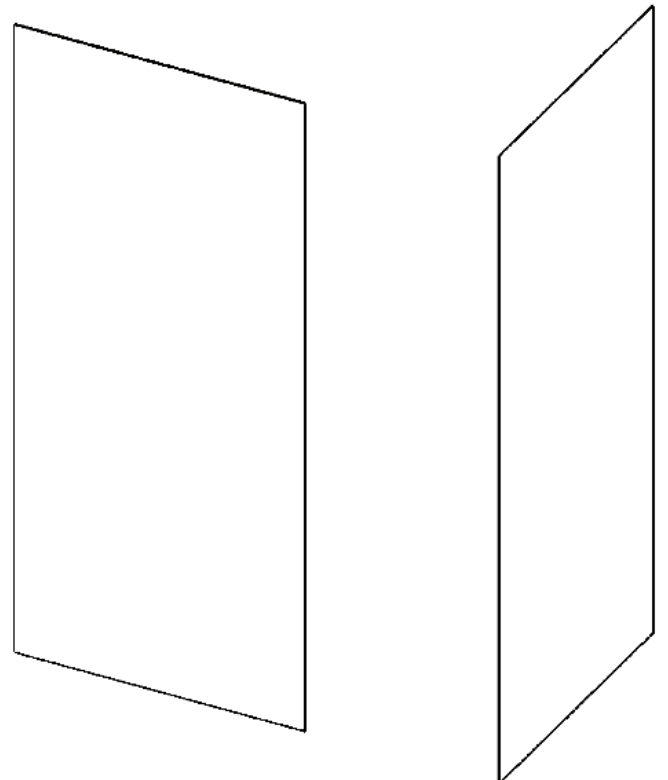

# SERENO WALK IN INSTALLATION INSTRUCTIONS

**NOTE:** Read and understand all instructions before installing shower.

## GENERAL SHOWER INFORMATION

- Due to weight of panels, 2 people may be needed to install shower.
- Walls must be plumb to a 2-3mm tolerance where shower is to be installed.
- Floor must be square to wall.

## GLASS SAFETY

- Keep glass standing upright.
- Always sit glass on a padded surface i.e. polystyrene.
- Take extra precautions with edges of glass panels.
- If toughened safety glass hits a hard surface or is hit by a hard object, it may shatter or compromise the integrity of the glass.
- It is recommended that safety gloves and glasses are worn during installation.

## SERENO WALK IN / /



## PARTS LIST

### INCLUDED

1. Glass Panels
2. Channel Extrusion Kits
3. Installation Kit
4. Silicone & Adhesive

### NEEDED

1. Caulking Gun
2. Level
3. Drill
4. Screw Driver
5. Spray Bottle with Soapy Water
6. Paper Towels
7. Tape Measure

# SERENO WALK IN INSTALLATION INSTRUCTIONS

## IMPORTANT INFORMATION

Please read all instructions and warranty information before beginning installation.

It is assumed that this instruction is being carried out by qualified trades-people.

## SERENO ORDER OF SHOWER INSTALLATION WITH TILED WALLS

1. Gib Lining
2. Water Proofing
3. Tiles
4. Channels
5. Glass

## SERENO ORDER OF SHOWER INSTALLATION WITH ACRYLIC LINER

1. Gib Lining
2. Acrylic Liner
3. Channels
4. Glass

# SERENEO WALK IN INSTALLATION INSTRUCTIONS

crest  
showers

## 1. TILING

Ensure tiling is done before the channels are installed.

## 2. INSTALLING GLAZING CHANNELS

- Use a 2 meter level to check walls are within 2-3mm of plumb.
- Using measurements on dimension sheet, mark out channel positions on floor tiles. Set out floor channels and check shower entry space dimensions are correct.
- Clean tiled floor and underside of channel with a dry rag. Run a thick bead of silicone along underside of floor channel (FIG 1).
- Place floor channel in position and press downwards. Remove plastic from stabilizer blocks and stick to base either side of channel to keep in place (FIG 2).
- Slide wall channel on top of floor channel, making sure they butt up to each other and insert channel connector inside 'wall to floor' join to help line up the wall channel (FIG 3).
- When plumb, drill 2 holes (3.5mmD) in wall channel, lining up with framing locations. (FIG 4). The top hole should be within 100mm of top of channel and the second hole within 1000mm of top of channel. No screws will be required lower than 1000mm up from the floor.
- Remove dust from holes and from inside floor channel. Clean underside of wall channel with a dry rag before running a thick bead (be very liberal to allow overflow and proper adhesion) of silicone in a continuous line down the entire length of the back of the wall channel (FIG 1) and place on wall.
- Inject silicone into and around screw holes (FIG 4). Ensure wall channel is plumb, then screw in place.
- Pop out channel connector and apply silicon into the floor to wall junction, placing the channel connector back in once done.

**IMPORTANT:**  
**PLEASE MEASURE WALL CHANNELS**

For walk in showers, wall channels will measure 1940mm.  
If custom panels, your wall channels will measure 10mm less than your glass height.

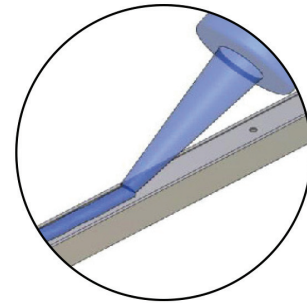

FIG 1.



FIG 2.



FIG 3.

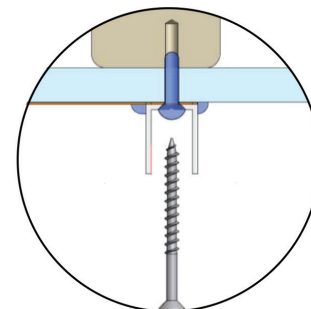

FIG 4.

GLAZING CHANNELS

## IMPORTANT

As an added waterproofing precaution, you can apply a continuous bead of silicon down the whole length of wall channel either on the interior or exterior of the wall channel as at your discretion.

# SERENO WALK IN INSTALLATION INSTRUCTIONS

## 3. TILING

If tiling, ensure this is done after the wall channels are installed, and before the glass panels are fitted.

**IMPORTANT:** We highly recommend dry fitting fixed panels prior to installation to ensure exact measurements of required walk in gap is achieved as pictured in supplied dimension sheet. Ensure all fixed panels are plumb and level. Use setting blocks as required to achieve this.

## 4. INSTALLING PANELS

- When panels are correctly aligned, remove panel and run a thick continuous line of silicone down the inside of the wall channel (FIG 6) and apply liberally in the base to channel join and along floor channel up to length of panel.
- Slide glass panel into position (FIG 7) and use small wedges (FIG 8) or a flat plastering blade to slide glass panel back to inside edge of channel and against silicone.

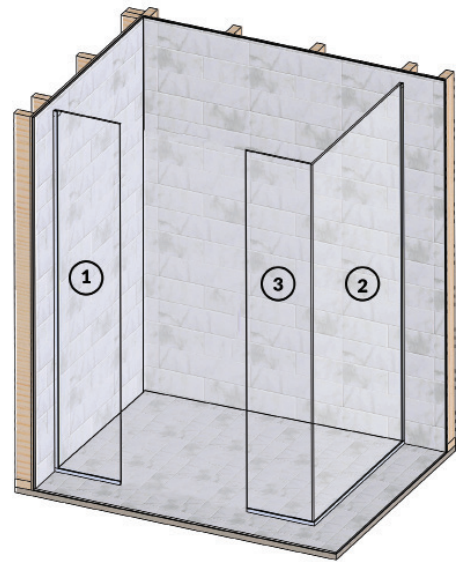

FIG 5.



FIG 6.

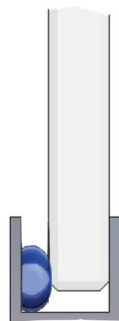

FIG 7.

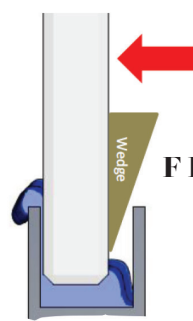

FIG 8.

# SERENO WALK IN INSTALLATION INSTRUCTIONS

## FOR WET SEAL ONLY 25x15mm COLORED CHANNELS:

Glazing wedge is not used instead you now need your caulking gun with desired silicone color, black N60 for black channels, clear N60 for everything else, you want the nozzle tip as small as possible, starting at the top of the wall channel on the inside of the shower, you now need to pump the silicone into the channel, you need to press hard. The process will fill up the void, eliminate visual bubbles and complete the seal. Work your way down the wall channel and along the floor channel. Repeat the process on the other side. Then spray with soapy water and tool off excess silicone 100%. Inspect and ensure you have a nice tidy finish.

## 5. FINISHING GLAZING CHANNEL TO GLASS PANEL JOIN

- Starting at the top of the wall channel, from outside shower, spray with warm soapy water then insert rubber wedge seal into gap (removing plastic wedges if used). (FIG 9) Leave rubber wedge protruding 40mm at top to cut off later.

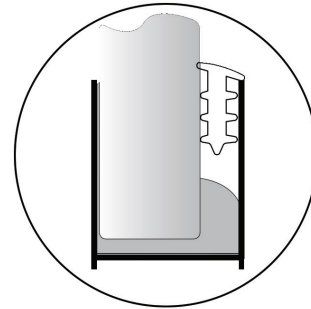

FIG 9.

**IMPORTANT:** Rubber wedge must be pressed into channel lightly from top to bottom before pushing right in. This method ensures rubber wedge does not set stretched and then shrink later.

- Repeat steps 3 and 4 with applicable panels.

## FOR GLASS TO GLASS JOINS:

- Apply masking tape down the length of the panel, allowing a 10mm gap for the glass to butt into for the glass to glass join (FIG 10).
- Run a continuous bead of silicon down entire length of 10mm face of installed wall to glass panel and across floor channel to the width of the glass to glass panel (FIG 11).
- Gently place glass to glass panel into siliconed floor channel and tilt gently upwards until it joins to glass to wall panel (FIG 12). Ensure there is no side to side movement while placing panel as this will smear silicone.
- Hold glass to glass join in place with masking tape.

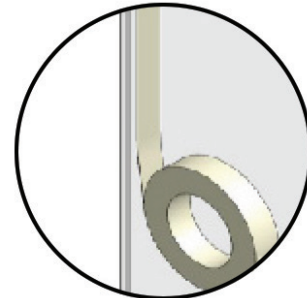

FIG 10.

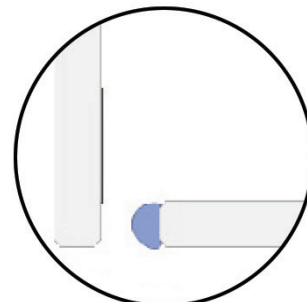

FIG 11.

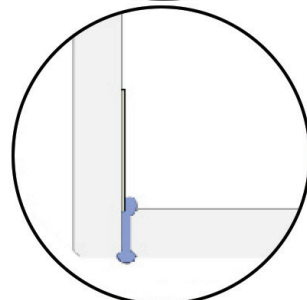

FIG 12.

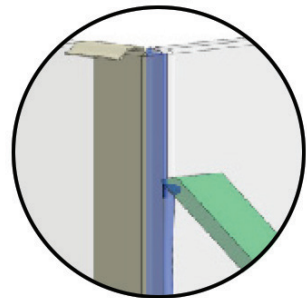

FIG 13.

- Cut off excess rubber wedge.
- Spray channels and glass with slightly soapy water then use spatula provided to clean off excess silicone (FIG 13). Repeat this process 3 times. Use minimal water then wipe off with paper towels.

## 6. INSTALLING SHELVES

Crest Showers Floating Glass Shower Shelf can be installed in any corner of a glass or tile wall. If two shelves are installed in the same corner, ideal shelf heights off the floor are 1200 & 1600mm. When installed in different corners, an ideal height is 1400mm off the floor.

When installing onto Seratone or Hardiglaze, apply masking tape to the liner then stick the stabiliser block to the masking tape. This makes the blocks easier to remove and protects the wall board surface.

We **DO NOT** recommend installing these on acrylic liners, due to adhesion difficulties.

**IMPORTANT:** Protect floor until adhesive has cured in case of the unlikely event that shelf/shower is disturbed and shelf falls off.

- Clean area shelf is being adhered, to ensuring it is free of any dust, soap scum, cleaners or any other substance.
- Remove backing from stabiliser blocks and press firmly onto wall (FIG 14).
- Place shelf in position and check for level. Optional - apply masking tape to shelf/wall (FIG 15).
- Remove shelf and put a thin bead of adhesive down both edges of shelf (FIG 16).
- Carefully place shelf on stabiliser blocks and gently push into corner. Check for level (FIG 17).
- Clean up adhesive with spatula. Remove masking tape.
- After 24-48 hours remove stabiliser blocks (FIG 18).

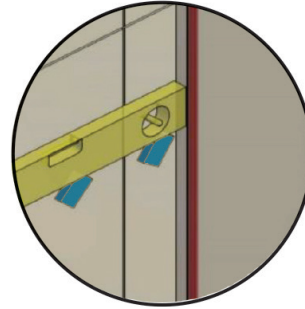

FIG 14.

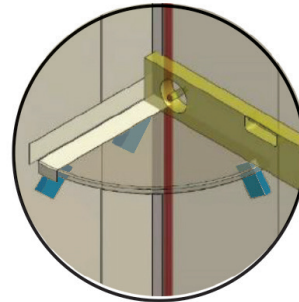

FIG 15.

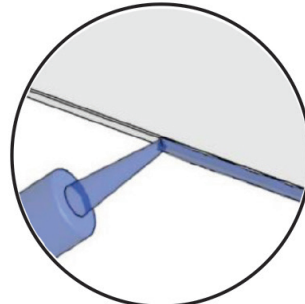

FIG 16.

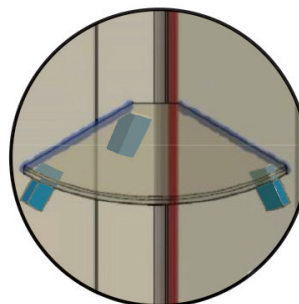

FIG 17.

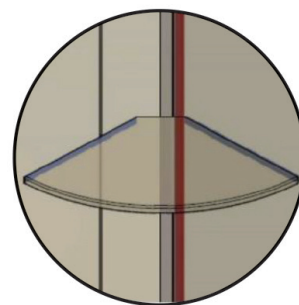

FIG 18.



# SERENO WALK IN INSTALLATION INSTRUCTIONS

crest  
showers

## 7. COMMISSIONING SHOWER

- Clean glass end ensure no silicone residue remains on glass, channel or surrounding area.

## 8. CARE AND MAINTENANCE

You can keep your Sereno shower looking it's very best by following a few simple guidelines:

- Clean shower twice weekly using a mild detergent in warm water and a soft lint free cloth. Ensure channels, hinges and handle are properly cleaned.
- A quick wipe down with a shower squeegee after each use will prohibit water staining the glass.
- Do not use abrasive cleaners or high strength chemicals on your shower.

COMMISSIONING

# SERENO WALK IN INSTALLATION INSTRUCTIONS

## 9. SERENO WARRANTY

Crest Shower Systems warrants that when installed as per the supplied instructions, the Sereno Shower System will be free from manufacturing defects for a period of 10 years from the date of sale. This means that apart from the typical surface splash, no water will be allowed to leak into the building structure for a minimum of 10 years.

All products supplied by Crest Shower Systems exceed the requirements of the New Zealand Building Code and all glass is manufactured to meet AS/NZS2208 1996 Grade A Safety Glass and is permanently marked as such in accordance with the code.

Crest Shower Systems will supply replacement parts or product at its discretion, free of charge where product is covered by this warranty and proof of defect has been received within 100 days of first appearance. To ensure warranty remains valid, the supplied care and maintenance instructions must be adhered to and the Crest Warranty form supplied with the product must be complete and returned at time of purchase (hard copy or Online). Warranty is non-transferable.

Crest will be liable for the replacement of products or components including their installation, or for an equivalent product including its installation, should the supplied product or component be declared defective by an authorised Crest Shower Systems representative. Beyond this, Crest will not be liable for any damages including incidental or consequential damages related to the use of this product.

Warranty does not apply to the following situations:

- Shower has been improperly installed.
- Shower has been misused or damaged.
- Shower damaged or defective prior to installation.
- Supplied instructions were not adhered to during installation. Note: Discretion must have been used at all times by installer as each situation may vary.

## INSTALLATION WARRANTY

Your approved Crest shower installer should provide you with a written 5 year minimum installation workmanship warranty. Product warranty applies regardless of who has installed the shower.

# WARNING

**This Sereno Shower has just been installed.**

**PLEASE DO NOT WORK IN OR AROUND THE SHOWER UNTIL**



**Any queries feel free to ring me on:**



**Best Regards  
Your Shower Installer**

**crest**  
showers

**CREST SHOWER SYSTEMS**

**W:** [www.crestshowers.co.nz](http://www.crestshowers.co.nz)

**E:** [sales@crestshowers.co.nz](mailto:sales@crestshowers.co.nz)

**P:** 0800 40 40 42