



BUILD YOUR OWN UNIT

FOX T



TOOLS NEEDED

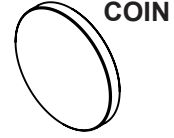
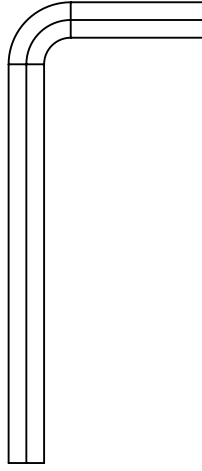
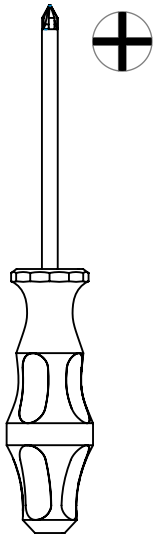

SCREWS, BOLTS AND PARTS

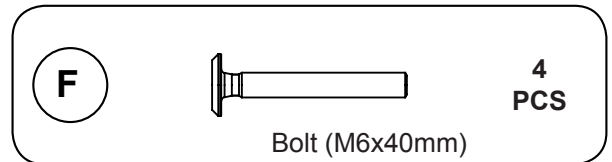
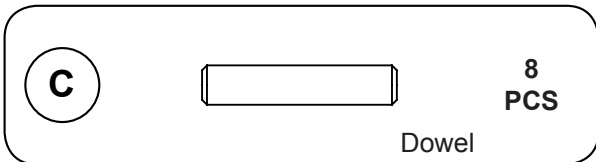
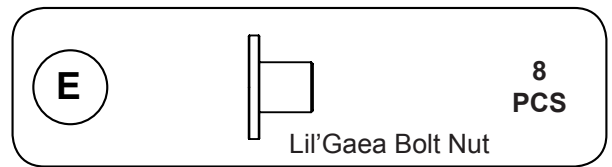
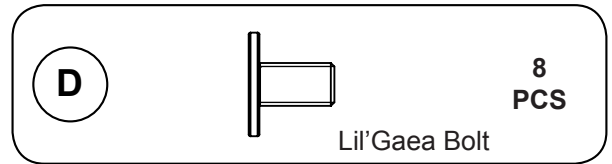
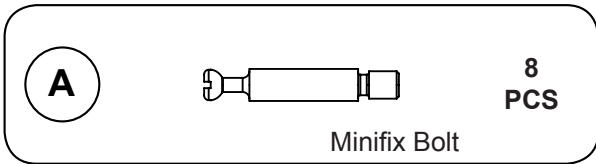

PARTS

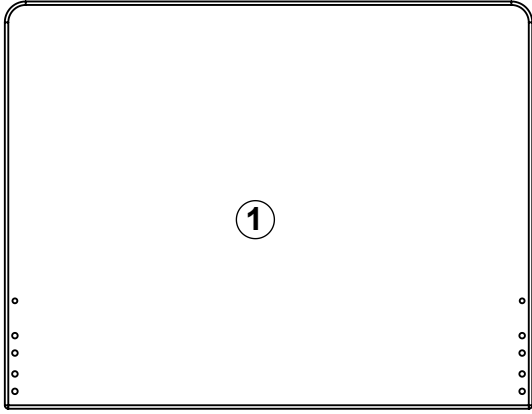

PARÇA 2
EKSİK

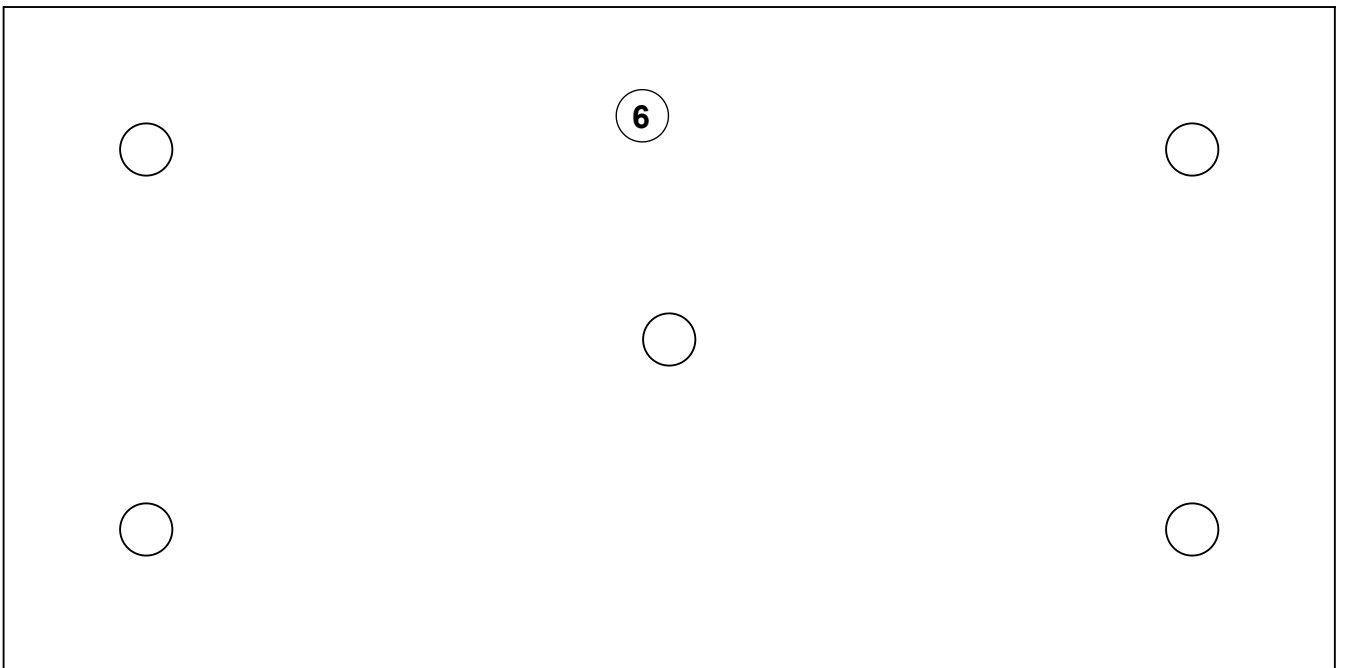
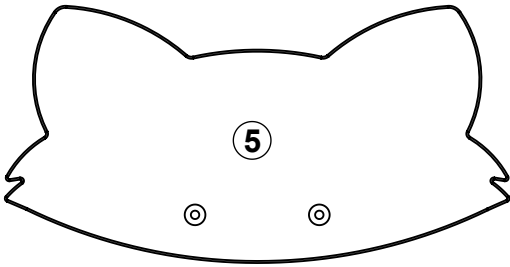
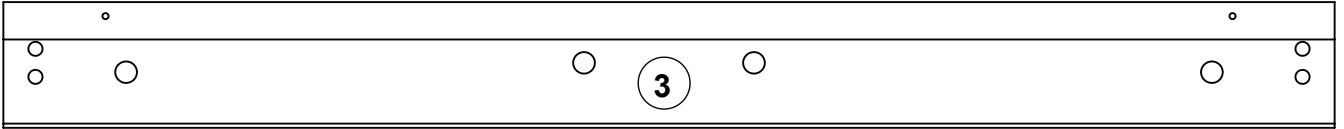

EXPLODED VIEW

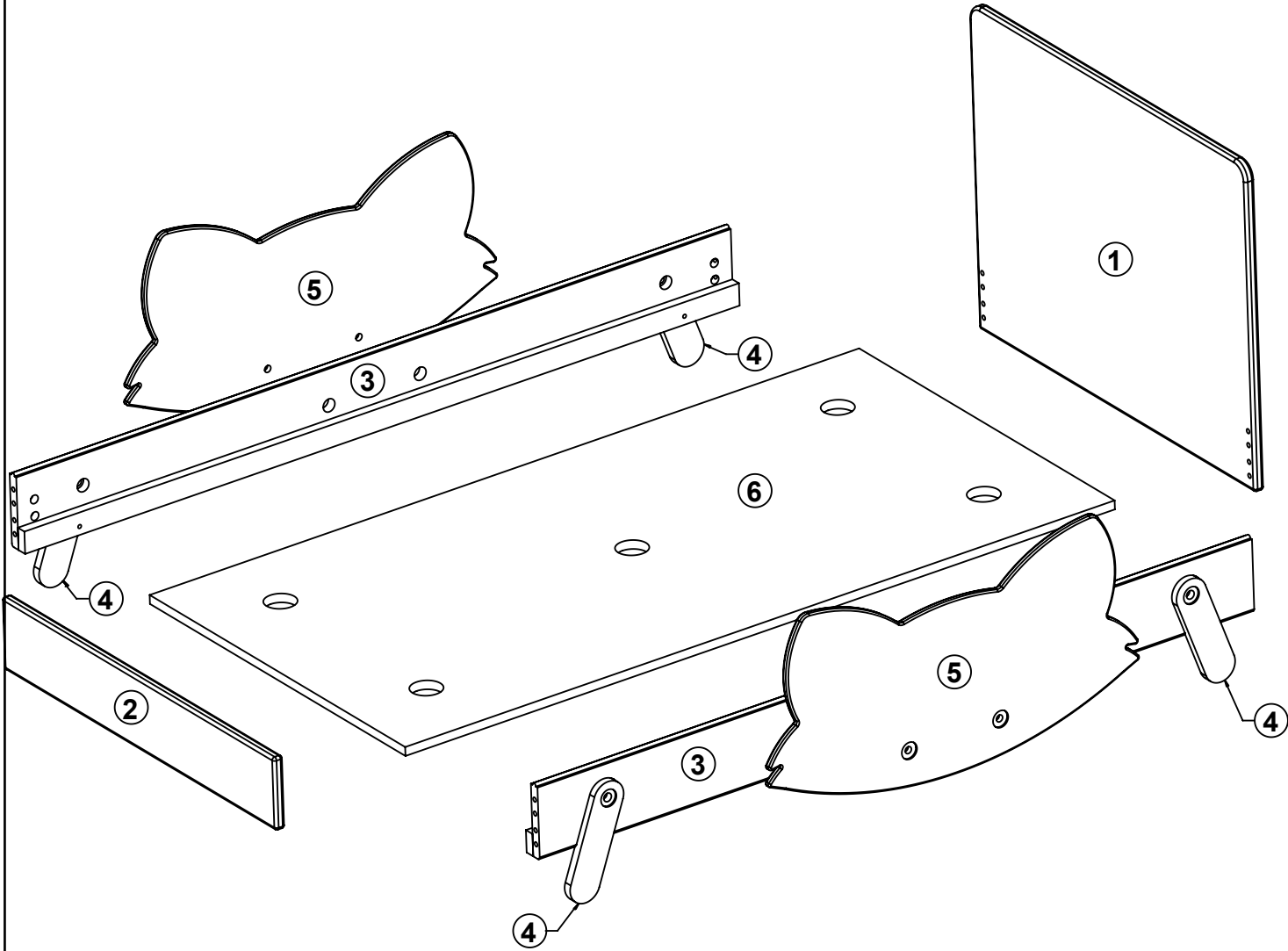

STEP 1

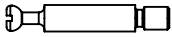
A  **8 PCS**
Minifix Bolt

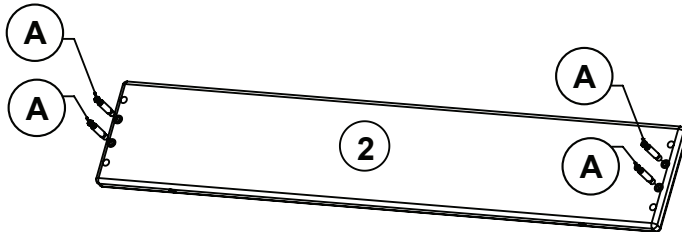
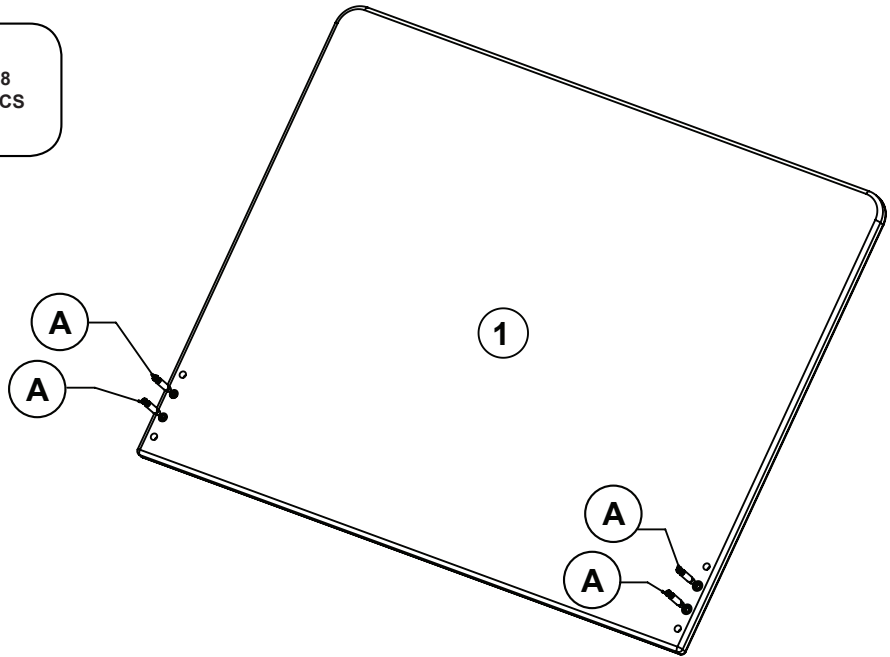

STEP 2

B  **8 pcs**
Minifix Body

C  **8 PCS**
Dowel

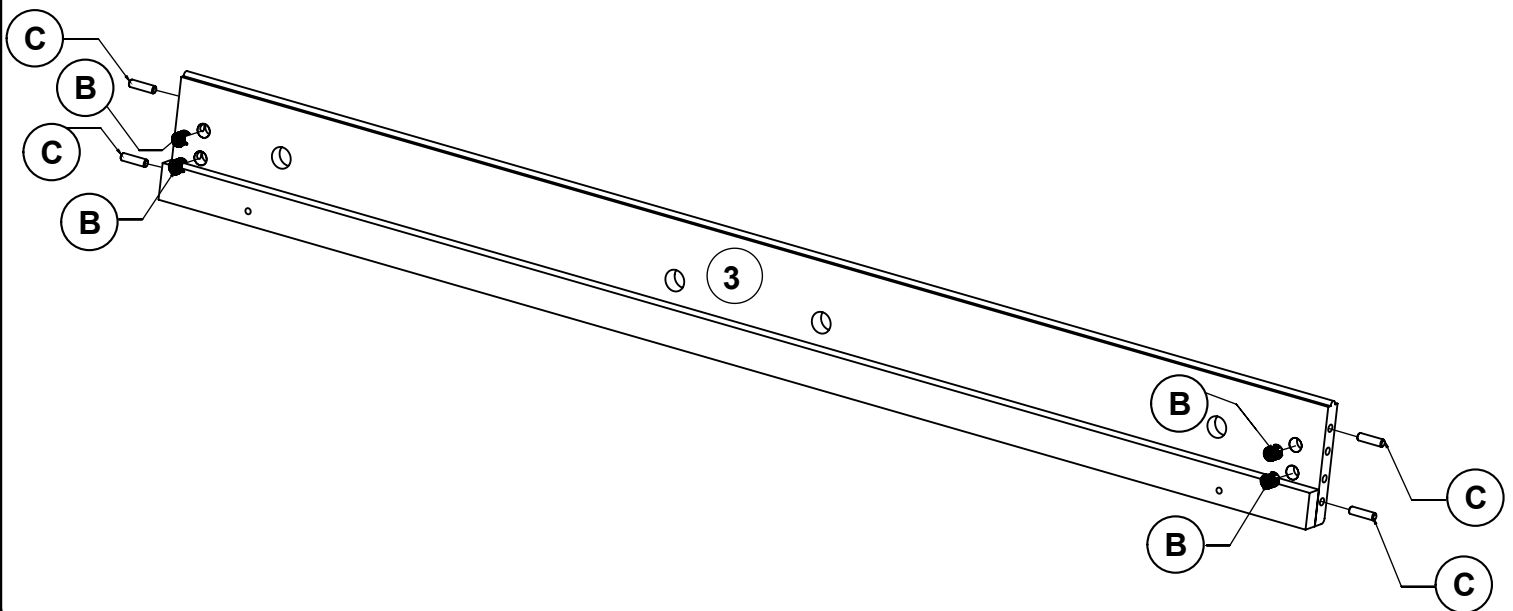

STEP 3

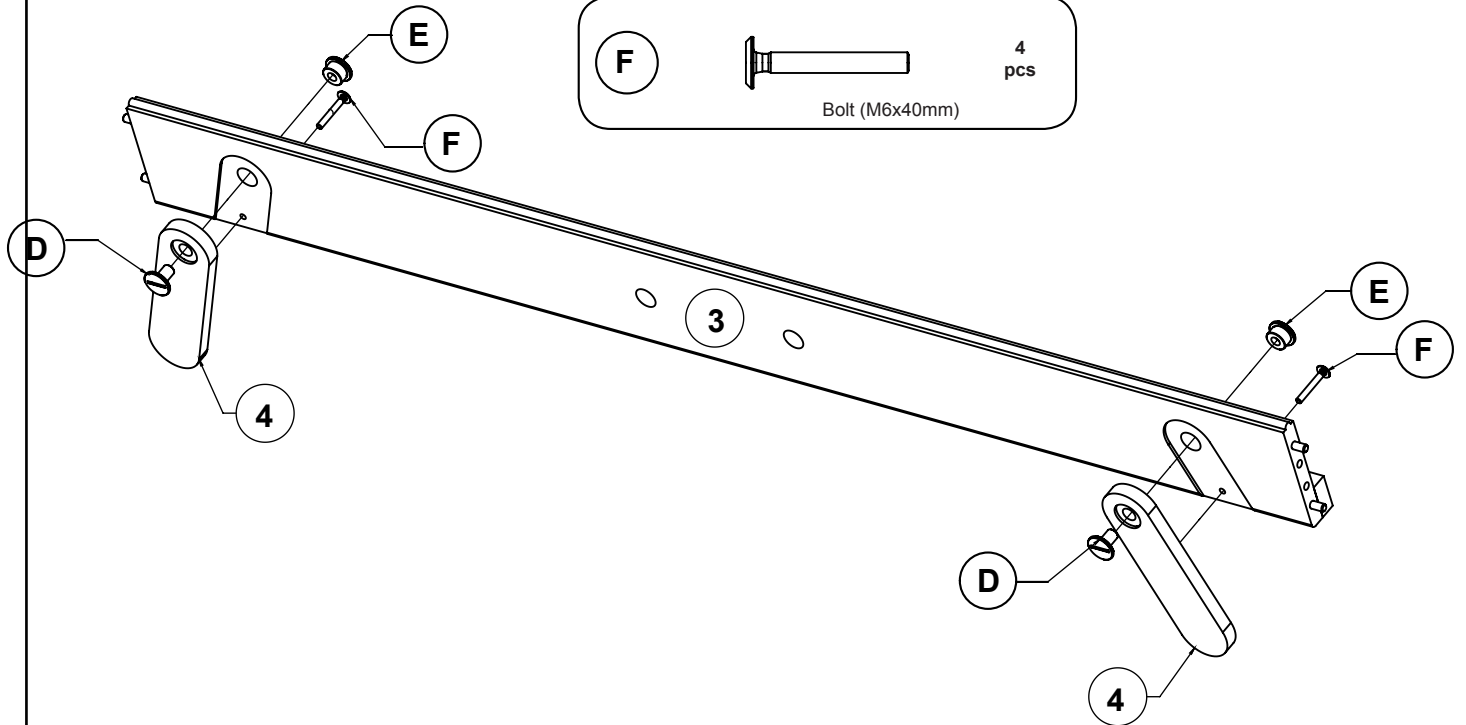
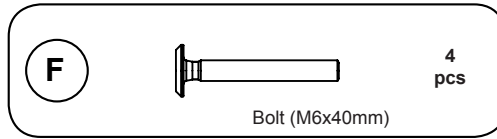
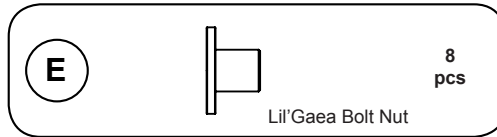
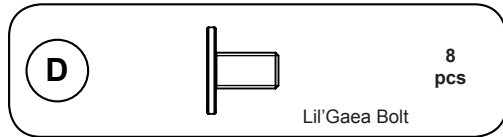

STEP 4

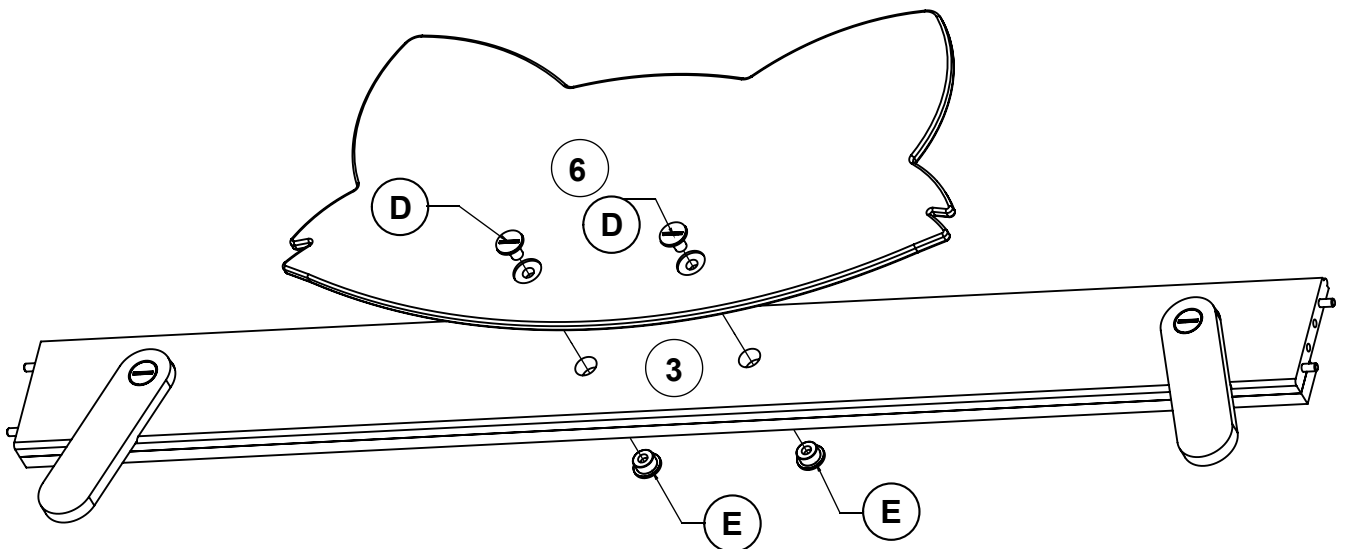
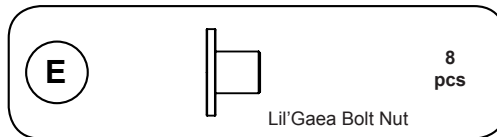
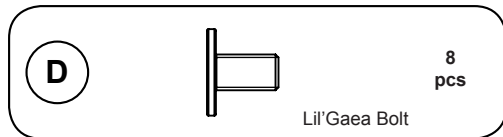

STEP 5

