

**KOOL  
KARZ**  
PLAYGROUND

# ELECTRIC CAR

Installation and User Manual

Manual has important information, read,  
please keep for future reference.

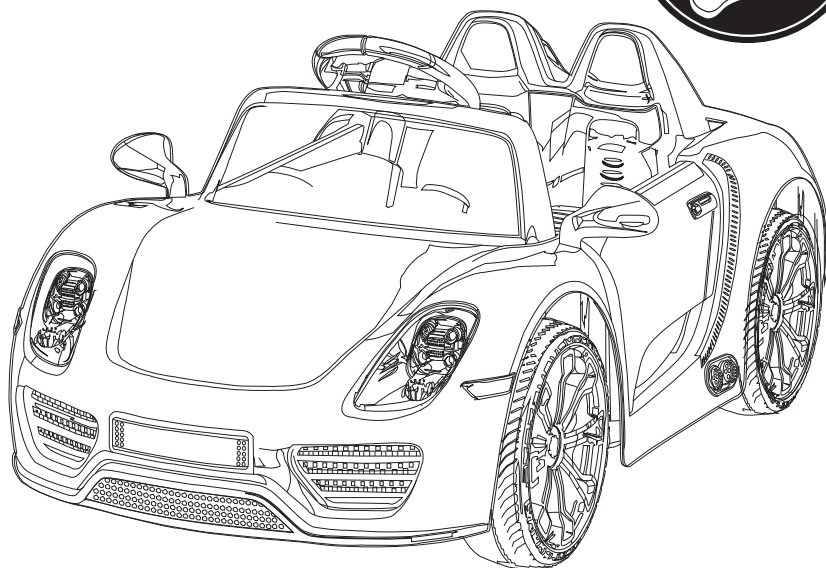

STANDARDS:EN71、 EN62115

Before using the product first read the instructions to understand the correct methods of operation and installation, and avoid damage or injury.

Manual should be kept safe for future reference.

STANDARD NO.:EN71 EN62115

## Specifications

Battery	2*6V4. 5AH / 2*6V7AH
Motor	12V25W、 12V15W
Charger	Input:AC220V-240V、 50HZ-60HZ,Output:DC12V1A
Maxmium load	30 KG
Work Time	Recharge 8-12h,Use for 1-2h
Speed	3-6. 5 KM/H
Age	37 months - 96months
R/C Battery	AA 1.5V
R/C Distance	20±5m

## SAFETY RULES

 <b>Warning</b>	<b>Not a transportation device. Toy must always be used under adult supervision.</b>
----------------------------------------------------------------------------------------------------	--------------------------------------------------------------------------------------

1. Must always be charged by an adult
2. Must always be used under adult supervision.
3. Not to be used on public roads or streets.
4. Suitable for children ages 37 – 96 months
5. Seat belt should always be worn and child should remain seated
6. Never try to ride vehicle over large obstacles or through rough terrain
7. Never Operate in wet conditions
8. Store in dry place

## Charging Method

1. To use first connect the battery terminals beneath the seat. red to positive, black to negative.
2. The charging port is located at the base of the seat.
3. Before first use charge battery for 10 hours to get the maximum life out of your battery.
4. Further charges should be 8-10 hours, never charge for more than 10 hours as this can cause damage to the battery.
5. Battery and charger may feel warm to the touch.
6. Only use the charger provided with the toy car, do not attempt to use any other charger.
7. Only use the battery provided with the toy car, do not attempt to use any aftermarket battery.
8. Always discontinue use and recharge battery when noticing a significant reduction in speed of the car.
9. Always put the charging cord away after use and do not allow children to use.
10. Always charge car at least once per month when not in use to maintain battery health.
11. Car cannot be turned on while charging.

## Package Contents

⦿ Car body	x 1	⦿ Wheels (2 front, and 2 rear)	x 4
⦿ Steering wheel	x 1	⦿ Aux cord	x 1
⦿ Seat	x 1	⦿ Instruction manual	x 1
⦿ Charger	x 1	⦿ Remote control	x 1

# Installation

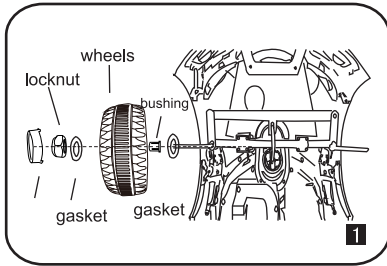

## Front Wheel Installation

To install front wheels begin by inserting small black plastic inserts into all 4 wheels and attach rims to outside of each wheel. Install a washer onto the axle followed by a finished front wheel another washer and finish with the lock nut then the center cover. Repeat for other side. (see figure 1)

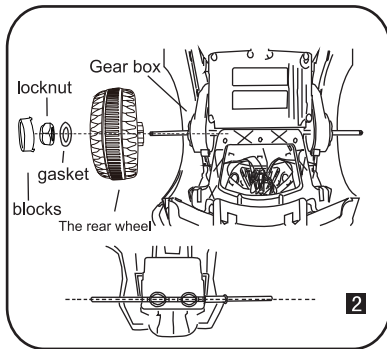

## Rear Wheel Installation

Install finished rear wheel on axle aligning gear on the back of the wheel with the white gear on the motor, add washer and lock nut then tighten. Repeat for other side then tighten locknuts on both sides together. Finish off with center cover on each wheel. (see figure 2)

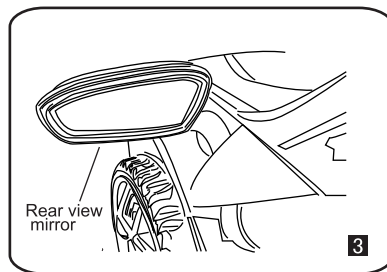

## Mirror / Windshield Installation

To install mirrors place in holes on either side of car above front wheels and press down gently until clips snap in place. To install windshield remove screws from base of windshield if already installed. Align windshield with gap behind dashboard and line up screw holes on either side of dashboard. Press gently along windshield to click in to place. Secure with screws on either side of dashboard. (see figure 3)

# Installation

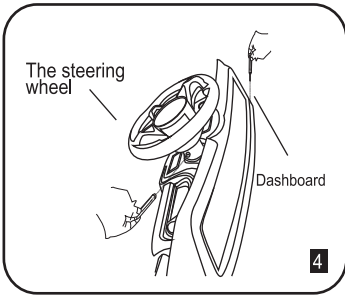

## Steering Wheel Installation

Begin by removing the pre-installed from loose steering wheel, connect the steering wheel wires to connector coming from the steering column. Align and place steering wheel on to steering column and line holes through steering wheel and rod. Finish by replacing screw through steering wheel and securing nut on other side. (see figure 4)

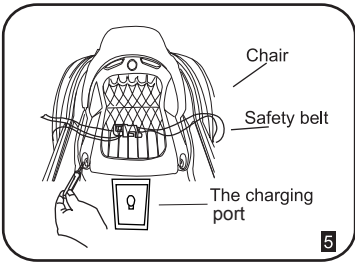

## Seat & Battery Installation

If there is a clear plastic cap remove from battery terminal without wire. Install loose battery cable on to exposed terminal. Turn the car on and ensure that reverse and forward gears function. Follow by installing rear spoiler / cover by aligning clips and pressing firmly along all sides until clips snap in place. Install seat with screws on left and right bottom, and center top in to plastic spoiler / cover. (see figure 5)

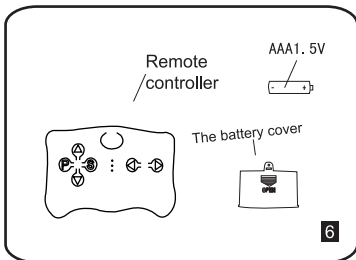

## Remote Pairing

Begin by installing AAA batteries into remote with car in off position. Hold the middle sync button for 3-5 seconds or until red lights flash. Turn on car and watch for the for lights to stop flashing on remote. Remote should be paired. "S" button will control 3 speed levels. "P" button will lock car and make lights on remote flash press again to unlock car. (see figure 6)

# Installation Information

---

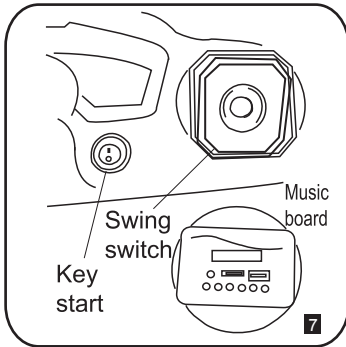

## Steering Wheel Installation

1. Turn on care using key switch, car should light up and start up sound should be heard
2. Test each steering wheel button to ensure sound plays.
3. To change volume press and hold the V- or V+ buttons until desired volume is reached.
4. The Music board features connections for USB, memory card, or AUX cable for MP3 playback
5. Press each button on the Music board to play different types of music, from left to right the buttons play Story, Song, Poetry, and Early Education.
6. Features a forward and backward switch, when forward is engaged press on the pedal to move forward. When backward is engaged press the pedal to go backwards.
7. Features key switch to start car.  
(See figure 7)

# Troubleshooting

<b>PROBLEM</b>	<b>CAUSE</b>	<b>SOLUTION</b>
Car doesn't work	Low power	Recharge the battery
	Damage to thermal fuse	Change to a new thermal fuse
	Loose wheel nut	Use new nut
	Loose battery connector	Tighten and re-connect battery
	Drained & bad battery	Replace battery
	Damage to electrical parts	Contact support
	Damage to motor	Contact Support
Car doesn't work	Loose battery connector	Tighten and re-connect battery
	Damage to charger	Change to a new charger
Short runtime	Battery with low power	Recharge the battery fully
	Battery is old	Replace battery
Noise or heat during charging	Normal Chemical process	Normal and safe chemical process
Low Speed	Old battery	Replace battery
	Low power	Recharge the battery fully
	Over burden	Reduce weight on car to under 25 KG
	Use on rough terrain or hills	Use on flat ground
Noise from gear box	Damage to gear box	Contact support
	Damage to motor	Contact support
Car shake when running	Loose motor connector	Tighten and re-connect motors
	Motor damaged	Contact support
No sound or lights when running	Loose wire	Connect wire securely
	Damage to electrical parts	Contact support
Car won't stop while running	Damage to electrical parts	Contact support
Unusual working condition	Remote battery drained	Replace batteries
	Remote control out of range	Reduce distance to 20-30m
	Damage to remote	Contact support
	Damage to receiver board	Contact support
	Interference	Move away from similar 2.4ghz devices

# Use Caution

1. Do not use on streets, slopes, ditches, and dangerous areas.
2. Avoid use on polished surfaces such as marble or tile.
3. Weight capacity is maximum 30 KG to operate properly
4. Do not alter any of the car circuits or electronics.
5. Keep away from sources of water or heat to avoid damage.
6. Do not attempt to ride over large obstacles or obstructions.
7. Do not use water or other liquids near electronic devices
8. Use caution when operating this car near other people or children.
9. If remote control battery is low please replace to ensure safe operation of vehicle.
10. When not in use please turn off the switch instead of disconnecting the battery.
11. Do not mix different types of batteries or new and old batteries.
12. Ensure the proper connections are made on all batteries, ex. positive and negative.
13. Batteries are only to be recharged by an adult.
14. Remove exhausted batteries from the toy.
15. Do not cause short circuit across the terminals.
16. Product must be assembled by an adult.
17. Always operate vehicle with adult supervision.



# Declaration

1. Manual is meant as a reference and some illustrations may not match exactly
2. In order to improve product quality, we may change the structure of the product, you may notice differences, please forgive any changes.
3. This package contains important information that must be kept.
4. Cannot be used in rainy days.
5. Do not use water to clean. To clean carefully use damp cloth away from electronics
6. Must be assembled by an adult.
7. Warning Protective equipment should be worn. Not to be used in traffic.
8. Toy operation requires skill, users should be careful when operating to avoid collision which could lead to injury and injury to others.

## Rules for Safe Use

- Must be assembled by an adult, please check for correct assembly.
- Do not use on streets, highways, and other dangerous locations.
- Children must be under adult supervision while using vehicle.
- When driving please do not quickly switch direction from forward to backward.
- Please check battery, charger, and wires for damage.
- If damage is found please stop using until the toy can be repaired.
- Battery must be connected to correct terminal.
- Exhausted batteries should be removed from the toy.
- Do not short connect the battery terminals.

## Safe Charging Rules

1. For first use of the car charge the battery for 10 hours to ensure full charge.
2. Recharge immediately if driving speed slows significantly. Charge for 8-10 hours. Never charge longer than 10 hours to avoid damage.
3. The charger and battery may get warm while in use. Up to 60°C is normal.
4. Use only the battery and charger provided with electric car to avoid damage to battery or circuits.
5. The car will not operate while charging. Do not move car while charging.
6. Please do not mix old and new batteries, or different battery types.
7. Before use please ensure the circuit connections are correct.
8. When not in use please charge at least once a month to keep battery cells active.

Warning: Electric cars used in non-private places may lead to drowning, burns, falls, or other hazards.



## Matters Needing Attention

Products should be assembled by adult before use.

Battery charging should be carried out by adults.

The first use of electric vehicle, charge the battery full for 10 hours, otherwise it could cause permanent damage.

Please don't use in the street, the road, and other dangerous places, and be sure to use under adult supervision.

This product is limited to one person, do not overload, the maximum capacity is 30 kg.

Please fasten the seat belt, and make sure that the rider is always sat in the seat while in the car.

Please don't suddenly change direction from forward to backward to avoid harm.

To prevent collisions please do not use in narrow space to avoid damage.

Please check the product and the charger, check the wires, plugs, packaging and components.

If damage is found stop use until repairs can be completed.

When not in use for a long time please turn the power off and remove the battery connector.

Children must use under adult supervision.

Safe use period: three years.