

WARMING TRENDS®

Owner's Guide and Instruction Manual



Thank you for your purchase!



Warming Trends V1.R2_5.3.2019

IMPORTANT PRODUCT WARNINGS



DANGER FIRE OR EXPLOSION HAZARD

If you smell gas:

- Shut off gas to the appliance.
- Extinguish any open flame.
- If odor continues, leave the area immediately.
- After leaving the area, call your gas supplier or fire department.
- Failure to follow these instructions could result in fire or explosion, which could cause property damage, personal injury, or death.



WARNING

Do not store or use gasoline, or other flammable vapors and liquids, in the vicinity of this or any other appliances.

An LP-cylinder not connected for use shall not be stored in the vicinity of this or any other appliance.



WARNING: For Outdoor Use Only.

Installation and service must be performed by a qualified installer, service agency, or the gas supplier.



WARNING: If the information in this manual is not followed exactly, a fire or explosion may result causing property damage, personal injury or loss of life.



DANGER!



CARBON MONOXIDE HAZARD

This appliance can produce carbon monoxide which has no odor.

Using it in an enclosed space can kill you.

Never use this appliance in an enclosed space such as a camper, tent, car or home.

INSTALLER: Leave this manual with the appliance.
CONSUMER: Retain this manual for future reference.

The installer is responsible for using the correct fuel line sizing and/or regulation to provide gas within the specified minimum and maximum gas inlet pressures of the fire feature.

AVERTISSEMENTS IMPORTANTS CONCERNANT LES PRODUITS

 **DANGER**
RISQUE D'INCENDIE OU D'EXPLOSION

S'il y a une odeur de gaz :

- Coupez l'admission de gaz de l'appareil.
- Éteindre toute flamme nue.
- Si l'odeur persiste, éloignez-vous de l'appareil et appelez immédiatement le fournisseur de gaz ou le service d'incendie.
- Si ces précautions ne sont pas respectées, cela pourrait provoquer un incendie ou une explosion, pouvant causer des dommages matériels, des blessures ou la mort.

 **AVERTISSEMENT**

Ne pas entreposer ni utiliser de l'essence ni d'autres vapeurs ou liquides inflammables dans le voisinage de l'appareil, ni de tout autre appareil.

Une bouteille de propane qui n'est pas raccordée en vue de son utilisation, ne doit pas être entreposée dans le voisinage de cet appareil ou de tout autre appareil.



AVERTISSEMENT: Pour utilisation à l'extérieur seulement.

L'installation et l'entretien doivent être effectués par un installateur qualifié, une agence de service ou le fournisseur de gaz.



AVERTISSEMENT: Si les informations de ce manuel ne sont pas suivies à la lettre, un incendie ou une explosion peut en résulter et causer des dommages matériels, des blessures corporelles ou la mort.

DANGER!

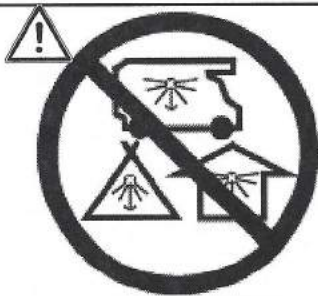

MONOXYDE DE CARBONE

Cette appareil peut produire du monoxyde de carbone, un gaz inodore.

L'utilisation de cet appareil dans des espaces clos peut entraîner la mort.

Ne jamais utiliser cet appareil dans un espace clos comme un véhicule de camping, une tente, une automobile ou une maison.

Ne pas utiliser cet appareil s'il a été plongé, même partiellement, dans l'eau. Appeler un technicien qualifié pour inspecter l'appareil et remplacer toute partie du système de commande et toute commande qui a été plongée dans l'eau.

INSTALLATEUR: Laissez ce manuel avec l'apppliance
CONSOMMATEUR:
Conservez ce manuel pour référence ultérieure.

Il incombe à l'installateur d'utiliser le dimensionnement et / ou la régulation corrects de la conduite de carburant pour fournir du gaz dans les pressions d'entrée minimum et maximum spécifiées pour la fonction incendie.

General Warnings and Information	5
Code Requirements	6
Minimum and Maximum Gas Inlet Pressures	6
Location Considerations	6
Construction of Enclosure	7
Clearances Diagram	8
General Burner System Installation	8
Match Lit System Connection Diagrams.....	10
(60K - 120K w/ FLKV12 and 121K - 249K w/ FLKV34FIT180)	
Match Lit System Connection Diagrams.....	12
(250K - 299K w/ DFLKV34FIT250 and 250K - 299K w/ DFLKV34FIT300)	
24 Volt Electronic Ignition System Connection Diagrams.....	14
(60K - 120K w/ FLKV12 and 121K - 249K w/ FLKV34FIT180)	
24 Volt Electronic Ignition System Connection Diagrams.....	16
(250K - 299K w/ DFLKV34FIT250 and 250K - 299K w/ DFLKV34FIT300)	
Push Button Ignition System Connection Diagrams.....	19
Media Installation	20
Operating Instructions	20
FireStorm Steel Gas Log Owner Information and Installation.....	21
General Maintenance.....	22
Troubleshooting.....	23
Warranty.....	24
Prop 65 Warning	25
Replacement Parts	26

CERTIFIED UNITS

Compliance with the following codes:

1. 2018, 2015, 2012, and 2009 *International Fire Code*® (IFC)
2. 2018, 2015, 2012, and 2009 *International Fuel Gas Code*® (IFGC)
3. 2015, 2012 and 2009 *Uniform Mechanical Code*® (UMC)*
4. 2015 and 2010 *Natural Gas and Propane Installation Code***

*Uniform Plumbing Code is a copyrighted publication of the International Association of Plumbing and Mechanical Officials

**Copyrighted publication of Canadian Standard Association



ICC-ES Report PMG-1213

Compliance with the following standards:

1. ANSI Z21.97/CSA 2.41-2017 Outdoor Decorative Gas Appliances

CERTIFIED MODELS

MATCH LIT:

- Model # CFB60 NG/LP as match lit
- Model # CFB120 NG/LP as match lit
- Model # CFB180 NG/LP as match lit
- Model # CFB290 NG/LP as match lit
- Model # CFBL90 NG/LP as match lit
- Model # CFBL110 NG/LP as match lit
- Model # CFBL130 NG/LP as match lit
- Model # CFBL150 NG/LP as match lit
- Model # CFBL190 NG/LP as match lit
- Model # CFBL210 NG/LP as match lit
- Model # CFBL250 NG/LP as match lit
- Model # CFBL270 NG/LP as match lit
- Model # CFBL320 NG/LP as matchlit
- Model # CFB60 2XL NG/LP as match lit
- Model # CFBH120 NG/LP as match lit
- Model # CFBH160 NG/LP as match lit
- Model # CFBH200 NG/LP as match lit
- Model # CFBH240 NG/LP as match lit
- Model # CFBH260 NG/LP as match lit
- Model # CFBH300 NG/LP as match lit
- Model # CFBH340 NG/LP as match lit
- Model # CFBH420 NG/LP as match lit
- Model # CFBT110 NG/LP as match lit
- Model # CFBT170 NG/LP as match lit
- Model # CFBT230 NG/LP as match lit

- Model # CFBT290 NG/LP as match lit
- Model # CFBT350 NG/LP as match lit
- Model # CFBT410 NG/LP as match lit
- Model # CFBT470 NG/LP as match lit

3V BATTERY OPERATED UNITS

- Model # CFB60 NG/LP with 3VIK
- Model # CFB120 NG/LP with 3VIK
- Model # CFB90LP NG/LP with 3VIK
- Model # CFBL110LP NG/LP with 3VIK
- Model # CFBL130LP NG/LP with 3VIK
- Model # CFBL190LP NG/LP with 3VIK
- Model # CFB60 2XL NG/LP with 3VIK
- Model # CFBH120LP NG/LP with 3VIK
- Model # CFBT110LP NG/LP with 3VIK

24 VOLT STANDARD ELECTRONIC IGNITION SYSTEMS - Standard Capacity

- Model # CFB60 NG/LP with 24VIKSC
- Model # CFB120 NG/LP with 24VIKSC
- Model # CFB180 NG/LP with 24VIKSC
- Model # CFBL90 NG/LP with 24VIKSC
- Model # CFBL110 NG/LP with 24VIKSC
- Model # CFBL130 NG/LP with 24VIKSC
- Model # CFBL150 NG/LP with 24VIKSC
- Model # CFBL190 NG/LP with 24VIKSC
- Model # CFB60 2XL NG/LP with 24VIKSC
- Model # CFBH120 NG/LP with 24VIKSC

- Model # CFBH160 NG/LP with 24VIKSC
- Model # CFBH200 NG/LP with 24VIKSC
- Model # CFBT110 NG/LP with 24VIKSC
- Model # CFBT170 NG/LP with 24VIKSC

24 VOLT STANDARD ELECTRONIC IGNITION SYSTEMS - High Capacity

- Model # CFB290 NG/LP with 24VIKHC
- Model # CFB300 NG/LP with 24VIKHC
- Model # CFBL210 NG/LP with 24VIKHC
- Model # CFBL250 NG/LP with 24VIKHC
- Model # CFBL270 NG/LP with 24VIKHC
- Model # CFBL320 NG/LP with 24VIKHC
- Model # CFBH240 NG/LP with 24VIKHC
- Model # CFBH260 NG/LP with 24VIKHC
- Model # CFBH300 NG/LP with 24VIKHC
- Model # CFBH340 NG/LP with 24VIKHC
- Model # CFBH420 NG/LP with 24VIKHC
- Model # CFBT230 NG/LP with 24VIKHC
- Model # CFBT290 NG/LP with 24VIKHC
- Model # CFBT350 NG/LP with 24VIKHC

24 VOLT PREMIUM ELECTRONIC IGNITION SYSTEMS - Standard Capacity

- Model # CFB60 NG/LP with P24VIKSCCG
- Model # CFB120 NG/LP with P24VIKSCCG
- Model # CFB180 NG/LP with P24VIKSCCG

Model # CFB290 NG/LP with P24VIKSCCG
Model # CFBL90 NG/LP with P24VIKSCCG
Model # CFBL110 NG/LP with P24VIKSCCG
Model # CFBL130 NG/LP with P24VIKSCCG
Model # CFBL150 NG/LP with P24VIKSCCG
Model # CFBL190 NG/LP with P24VIKSCCG
Model # CFBL210 NG/LP with P24VIKSCCG
Model # CFBL250 NG/LP with P24VIKSCCG
Model # CFBL270 NG/LP with P24VIKSCCG
Model # CFB60 2XL NG/LP with P24VIKSCCG

Model # CFBH120 NG/LP with P24VIKSCCG
Model # CFBH160 NG/LP with P24VIKSCCG
Model # CFBH200 NG/LP with P24VIKSCCG
Model # CFBH240 NG/LP with P24VIKSCCG
Model # CFBH260 NG/LP with P24VIKSCCG
Model # CFBT110 NG/LP with P24VIKSCCG
Model # CFBT170 NG/LP with P24VIKSCCG
Model # CFBT230 NG/LP with P24VIKSCCG
Model # CFBT290 NG/LP with P24VIKSCCG

24 VOLT PREMIUM ELECTRONIC
IGNITION SYSTEMS - High Capacity
Model # CFB300 NG/LP with P24VIKHCCG
Model # CFBL320 NG/LP with P24VIKHCCG
Model # CFBH300 NG/LP with P24VIKHCCG
Model # CFBH340 NG/LP with P24VIKHCCG
Model # CFBH420 NG/LP with P24VIKHCCG
Model # CFBT350 NG/LP with P24VIKHCCG
Model # CFBT410 NG/LP with P24VIKHCCG
Model # CFBT470 NG/LP with P24VIKHCCG

GENERAL INFORMATION

This Owner's Guide and Instruction Manual contains critical information for the safe installation and operation of your Warming Trends™ fire feature. **You must read this manual in its entirety prior to installation and/or operation.**

Failure to follow these instructions may result in property damage, personal injury, or death.

WARNING:

HOT! DO NOT TOUCH.

SEVERE BURNS MAY RESULT.

CLOTHING IGNITION MAY RESULT.

- **Young children should be carefully supervised when they are in the area of the appliance.**
- **Clothing or other flammable materials should not be hung from the appliance or placed on or near the appliance.**
- **Children and adults should be alerted to the hazards of high surface temperatures and should stay away to avoid burns or clothing ignition.**

WARRANTY REQUIREMENT:

When not in use, appliance must be covered at all times. Failure to cover the fire feature will void the warranty.

We strongly recommend our products be installed and serviced by locally licensed professionals. It is the installer's responsibility to read the Installation Manual thoroughly before installing or servicing this equipment to ensure a safe installation and to educate the end user as to proper operation. Warming Trends™ is not responsible for damage due to improperly installed or operated units. Installers must leave this manual with the end user. Instructions are updated as needed, and it is the installer or owners' responsibility to periodically review Warming Trends® website for applicable updates (www.Warming-Trends.com.) Please keep this manual with your important papers.

WARNING:

Do not use appliance if any part has been under water. Immediately call a qualified service technician to inspect the appliance and to replace any part of the control system and any gas control that has been under water.

WARNING:

DO NOT USE OXYGEN MIXERS WITH YOUR WARMING TRENDS® APPLIANCE. Mixers may create leakage in the cavity of the pit and could cause fire or explosion which could cause property damage, personal injury, or death.

WARNING:

Product is not intended to be used to burn wood or other combustibles. Solid fuels shall not be burned in the appliance. Do not put any combustible materials into the fire pit.

WARNING:

Only use Liquid Propane or Natural Gas as specified for your Warming Trends® appliance or burner. Do not use an alternative fuel.

CODE REQUIREMENTS

It is the responsibility of the installer to consult with the local municipality and to **FOLLOW ALL LOCAL CODES** concerning the installation and operation of the fire feature.

When the appliance is for connection to a fixed piping system, the installation must conform with local codes, or in the absence of local codes with the *National Fuel Gas Code, ANSI Z223.1-NFPA54; National Fuel Gas and Propane Installation Code, CSA B149.1; or Propane Storage and Handling Code, CSAB149.2, as applicable.*

For systems with electronic ignitions:

The appliance when installed, must be electrically grounded in accordance with local codes, or in the absence of local codes, with the *National Electrical Code, ANSI/NFPA 70; or the Canadian Electrical Code, CSA C22.1, if applicable.*

Minimum and Maximum Gas Inlet Pressures

The installer is responsible for using the correct fuel lines and/or regulation to provide gas to the fire feature within the specified minimum and maximum gas inlet pressures below:

Gas Inlet Pressures

MATCH LIGHT	Minimum	Maximum
Natural Gas	3.5" W.C. (.8718 Kpa)	7.0" W.C. (1.7436 Kpa)
Liquid Propane	11.0" W.C. (2.7399 Kpa)	13.0" W.C. (3.2381 Kpa)
STANDARD - 24VIKHC	Minimum	Maximum
Natural Gas	3.0" W.C. (.7472 Kpa)	5.0" W.C. (1.2454 Kpa)
Liquid Propane	8.0" W.C. (1.9927 Kpa)	12.0" W.C. (2.989 Kpa)
3V - 3VIK	Minimum	Maximum
Natural Gas	4.5" W.C. (1.1209 Kpa)	10.0" W.C. (2.4908 Kpa)
Liquid Propane	11.0" W.C. (2.7399 Kpa)	13.0" W.C. (3.2381 Kpa)
PREMIUM - P24VIKSC, P24VIKHC,	Minimum	Maximum
Natural Gas	3.5" W.C. (.8718 Kpa)	14.0" W.C. (3.4872 Kpa)
Liquid Propane	8.0" W.C. (1.9927 Kpa)	14.0" W.C. (3.4872 Kpa)

LOCATION CONSIDERATIONS

All appliances, match lit kits, spark ignition, and electronic ignition systems are designed and intended for outdoor use only.

For electronic ignition models, there must be an electrical shut off (wall switch or breaker) on the exterior of the appliance or on adjacent structure to allow for emergency shutdown and maintenance. Distance may be determined by local code.

All appliances must have a gas shutoff located outside of the appliance to allow for emergency shut off and maintenance.

Select a location where the appliance can be attended during operation. Never leave an operating appliance unattended or by someone not familiar with its operation or emergency shut off locations.

Appliances create very high temperatures - combustibles must be located far enough away that there is no risk of ignition.

IMPORTANT: It is recommended that material such as granite, marble or other dense stone be kept an appropriate distance away from flame due to risk of cracking. Manufacturer is not responsible for damage to any enclosure material for any reason.

FIRE PIT CLEARANCES

- 36" horizontally from any combustible structure or materials.
- Overhead clearance should be a minimum of 120" from combustible structures or materials.
- Choose a location that allows easy access for installation and maintenance of the fire feature.
- Pick a location that allows sufficient horizontal room to enjoy the appliance while allowing a safe distance from the heat and flame.
- Always consult with local municipality regarding any local code requirements.
- See Clearance Diagram on page 8.

The enclosure must be constructed on a stable surface. The weight of the burner system must be supported by the plate or pan and not by any control/valve box. For electronic ignition models, the control/valve box must be above grade with adequate drainage to prevent water damage to the controls inside the box. Installer is responsible for ensuring there is enough space for electronics - see technical drawings provided by manufacturer. Installer is responsible to ensure that the structure is level. **Blocks, bricks, L-brackets, or metal collars can be used to build a support ledge for the system plate or pan.**

CONSTRUCTION OF ENCLOSURE

WARNING:

All appliances must have a gas shutoff on the outside of the fire pit to allow for emergency shut off and maintenance.

WARNING:

For electronic ignition models, there must be an electrical shut off (wall switch or breaker) on the exterior of the appliance or on adjacent structure to allow for emergency shutdown and maintenance. Verify correct power supply.

Key valve should be mounted below the plate and through the side wall of the vessel.

Always use proper materials and construction for gas supply, power and enclosure. Materials must be non-combustible in both initial installations as well as over time.

For electronic ignition models requiring power supply - a qualified, licensed electrician must install power supply.

The unit may be hardwired or an outdoor NEMA rated GFCI Receptacle outlet can be installed on the interior of the enclosure above grade to supply power to system.

Minimum ventilation requirement: Incorporate 1 vent on at least two opposing sides (2 vents total) at a minimum size of 18 sq. inches each (Example: 3"x 6" or larger). Installation of the vents in the mid to lower area of the enclosure is recommended. Ventilation allows for heat and/or residual fuel to escape. Failure to properly vent enclosure may result in the appliance overheating or explosion. Overheating could lead to heat damage to internal components. Some enclosures may require more ventilation based on material, size, and extended use. Always consult with local municipality regarding any code requirements.

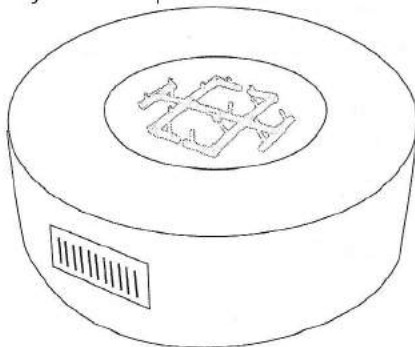

Ready-to-Finish Kits come with Fire Pit Vent Kit (FPVK). Vents do not come pre-installed on Ready-to-Finish Kit as placement and installation depends on veneer. Vents to be installed by contractor on site.

The interior space of the enclosure cannot be filled with any material (gravel, crushed rock, concrete, etc.).

The appliance assembly should be recessed 4" - 6" from the top of the enclosure to protect flame from excessive wind. Some conditions may require deeper recession.

It is the responsibility of the installer to provide proper installation to allow for easy accessibility for service and/or repairs. Installer must not build capstone inner ledge over outer lip of plates or pans (unless access panel door or alternate access is incorporated). Building capstone inner ledge over outer edge of plates or pans will impede access to system and result in the need to crack or remove capstones to gain access. Warming Trends is not responsible for damage to enclosure for any reason whatsoever.

WARNING: These instructions do not apply to vessels or appliances with self contained propane gas supply systems. Appliances or vessels with self contained propane gas supply systems have additional specific requirements which must be identified and met by the vessel installer or manufacturer. Please consult with a qualified installer for guidance and required installation procedures.

CLEARANCES DIAGRAM

Vertical clearance of 120" from burner to combustible structure or materials is required. Horizontal or lateral clearance of 36" between edge of burner and combustible structure or materials is required.

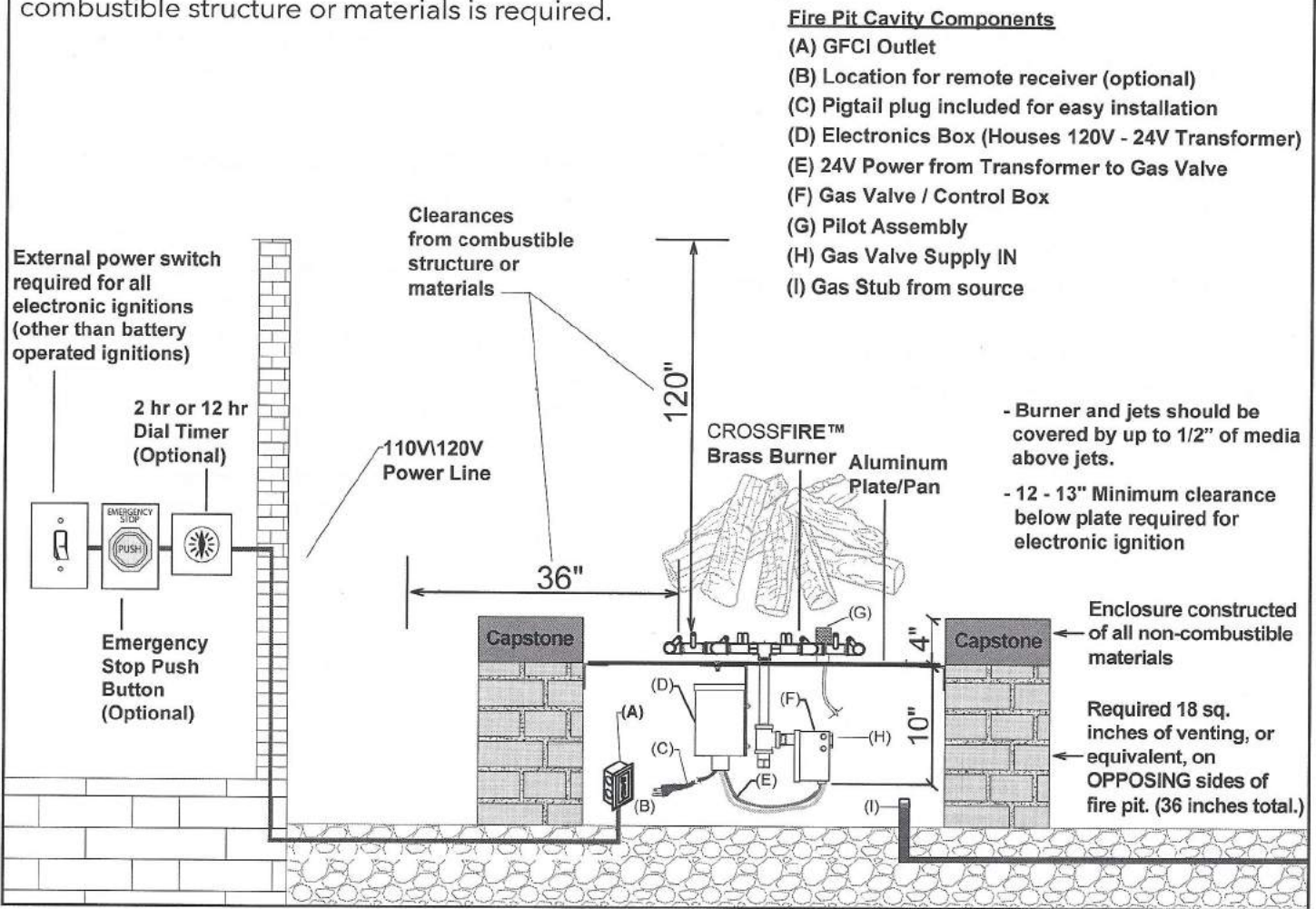

GENERAL INSTALLATION INSTRUCTIONS

Use only joint compound, thread sealant, or tape specific to gas use that is resistant to all gases. Apply joint compound, thread sealant or tape to all male pipe fittings only and **DO NOT USE ON FLARED FITTINGS**. Be sure to tighten every joint securely.

Ignition systems are recommended on any burner over 300K BTUs. If you are lighting manually be sure to maintain a minimum safe distance to avoid property damage, personal injury, or death. Please refer to match lit instructions.

1. Verify gas supply matches burner type.
2. Verify gas inlet pressure is within the specified minimum and maximum pressures. Consult Gas Inlet Pressures on page 6.
3. Purge gas lines of air, water and debris.
4. Perform all leak tests with leak detector or leak reactant on main gas supply and repair leaks as necessary. Turn off gas supply.
5. For models that include electronic ignitions, be sure to

have a qualified electrician install proper power supply following all local codes.

6. Inspect flex line(s) for punctures or breaks in line(s).
7. **Make sure the key turns in the key valve before installing.** Use only your hand to turn the gas key valve. Never use tools. If the key valve will not turn by hand, don't try to repair it. Force or attempted repair may cause a fire or explosion.
8. **Refer to Connection Diagrams starting on page 10 for applicable gas connections.**
9. Position burner safely with access to all gas connections for testing.
10. Turn on gas supply to preform repeat leak tests on main gas supply and all connections to appliance and repair as needed.
11. Do not use appliance if there is evidence of leaking gas. If leak is suspected, turn off main gas supply immediately. For appliances for use with a fixed fuel piping system and equipped with an appliance gas pressure regulator, the

appliance and its individual shutoff valve must be disconnected from the gas supply piping system during any pressure testing of that system at test pressure in excess of ½ psi (3.5kPa);

The appliance must be isolated from the gas supply piping system by closing its individual manual shutoff valve during any pressure testing of the gas supply piping system at test pressures equal to or less than ½ psi (3.5 kPa).

12. Ignite burner. See applicable ignition instructions within Operating Instructions, page 20.
13. Electronic ignitions can either be hard wired into main power supply or plugged into a location-specific outlet/receptacle per local codes. **The electrical supply must be connected to an ON/OFF switch that is external to the pit.** Remote controls, emergency stops, and dial timers are optional add-ons.
14. Once appliance is lit, perform leak test on all gas connections and repair as needed.
15. Turn off appliance and allow to cool.
16. Set appliance into properly constructed, level, non-combustible enclosure. The enclosure must be on a stable surface. The weight of the appliance must be supported by the plate or pan and not by any control box or gas valve. Blocks, bricks, metal collars or L-brackets can be used to build a support ledge for the system plate or pan. Control boxes and gas valves must be above grade with adequate drainage to prevent water damage. Installer is responsible for making sure there is enough space in the cavity for any electronics and piping. **The interior space of the enclosure cannot be filled with any material (i.e. gravel, crushed rock, concrete, etc).** The fire pit assembly should be recessed 4" to 6" from the top of the enclosure to protect flame from excessive wind and to allow coverage of burner. See Clearances Diagram for details.
17. To allow for regular maintenance, any capstone materials should not overhang the interior edge of the fire pit. See **Clearances Diagram** on page 8 for placement. Warming Trends® is not responsible for any damages to the capstone.
18. Venting is required to avoid heat damage to internal components and to allow airflow in case of gas pooling. Incorporate 1 vent on at least two opposing sides (2 vents total) at a minimum size of 18 sq. inches each for 36" total (example: 3"x 6"). Installation of the vents in the mid to lower area of the enclosure is recommended. Some enclosures may require more ventilation based on material, size, and extended use. Ready-to-Finish Kits come with Fire Pit Vent Kit (FPVK). Vents do not come pre-installed on Ready-to-Finish. Fire Pit Vent Kits must be installed on site.
19. Only use fire rated media (glass, lava rock, log sets, etc.) approved for use with high temperatures that have been manufactured for specific use in fire features. Never use any material for media that is non-porous and holds moisture such as gravel, pebbles, river rock, etc. Such material, when heated, may cause the trapped moisture to boil, fracture unexpectedly and/

or explode and which could cause personal injury, damage or death.

20. To avoid dust and clogs getting into the system, do not dump the media over the burner. Place the media onto the plate or pan. **Burner should be covered by approved media up to ½" above the jets. Media may be positioned so that jet tips or barrels are visible. Excessive media coverage may cause back pressure and dangerous pooling of gas which can result in explosion which could cause property damage, personal injury, or death.**
21. Do not cover the ignition pilot assembly or wind cage more than half way with any form of media. Do not place ceramic logs too close to the pilot assembly as this may cause excessive heat and system failure that is not covered by warranty.
22. **Ceramic log sets, must be pre-treated before use to avoid breaking or crumbling.** Burn logs for 15 minutes, then leave untouched to cool for at least one hour before moving them again, or they could break or crumble.
23. Complete final verification of correct operation and lighting.
24. Review instruction manual with end user and instruct end user not to change/ modify fire pit or media in any way.

The following label has been provided with the appliance. Affix the label in a conspicuous location adjacent to the appliance.



WARNING: Improper installation, adjustment alteration, service or maintenance can cause property damage, personal injury or loss of life. Refer to the owner's information manual provided with this appliance. Installation and service must be performed by a qualified installer, service agency, or the gas supplier.



WARNING: Do not store or use gasoline, or other flammable vapors and liquids, in the vicinity of this or any other appliances.

An LP-cylinder not connected for use shall not be stored in the vicinity of this or any other appliance.



AVERTISSEMENT: Une installation, un ajustement, une modification, une réparation ou un entretien inapproprié peuvent être la cause de blessures ou de dommages. Veuillez lire attentivement les instructions d'installation, d'utilisation et d'entretien avant d'installer ou de réparer ce matériel.



AVERTISSEMENT: Ne pas entreposer ni utiliser de l'essence ni d'autres vapeurs ou liquides inflammables dans le voisinage de l'appareil, ni de tout autre appareil.

Un bouteille de propane qui n'est pas raccordée en vue de son utilisation, ne doit pas être entreposée dans le voisinage de cet appareil ou de tout autre appareil.

Leave this Connection Diagram with end user.

MATCH LIT SYSTEM CONNECTION DIAGRAMS

60K - 249K BTU Systems

60K - 120K WITH FLKV12 (Follow steps 1 - 6)

121K - 249K WITH FLKV34FIT180 (Follow steps 1 - 6, including 3A)

1. Locate FLKV12 (or FLKV34FIT180)

Parts include Whistle-Free Flex Line, key valve, escutcheon plate, keys, and FIT180 (FLKV34FIT180 ONLY)

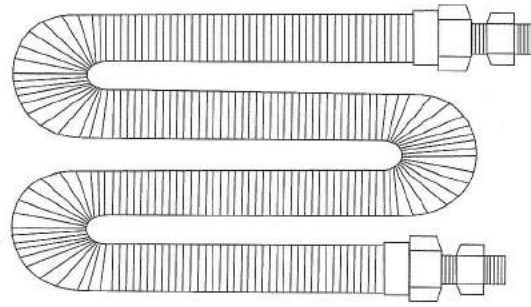
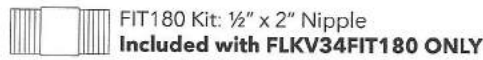
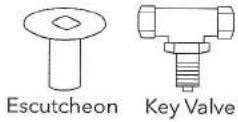
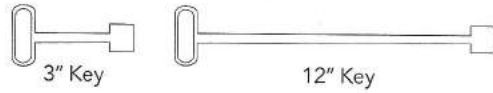

Whistle-Free Flex Line

2. Remove Flared Fittings from Whistle-Free Flex Line

(FLKV12 and FLKV34FIT180)

Removing flared fittings first makes installation easier.

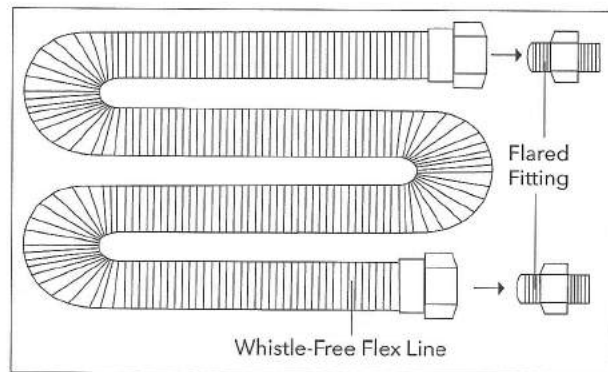
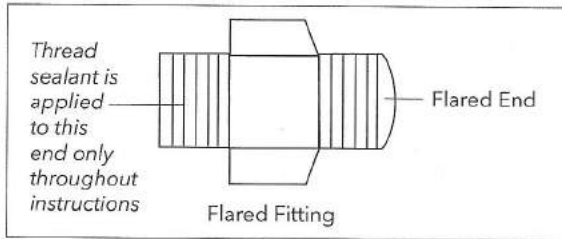

3. Connect to Coupling

(FLKV12) Connect one of your 1/2" Flared Fittings removed in Step 2 to the 1/2" coupling located on the bottom of the aluminum plate with flared end on bottom. Tighten.

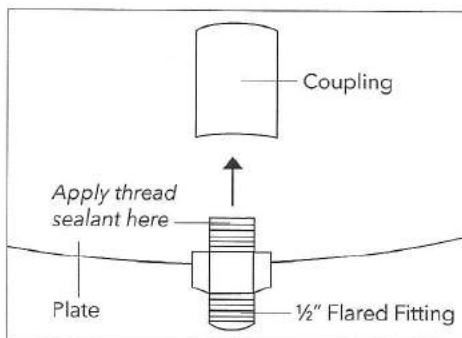

3A. Connect to FIT180, then to Coupling

(FLKV34FIT180) Connect one 3/4" Flared Fitting removed in Step 2 to FIT180 fitting provided by inserting FIT180 into interior threads of the Flared Fitting. Tighten.

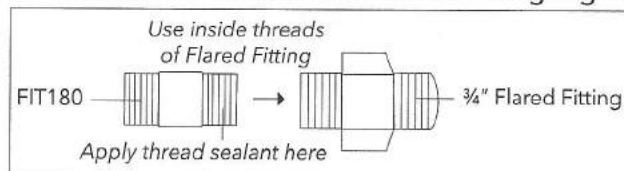

Then, connect the FIT180 fitting into the coupling located on the bottom of the aluminum plate. Tighten.

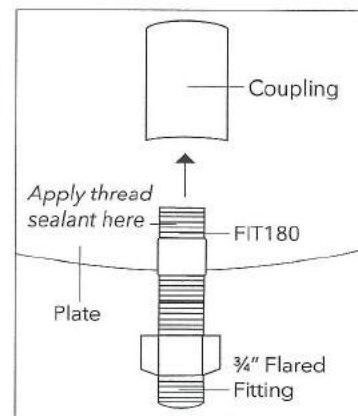

4. Connect Whistle-Free Flex Line

(FLKV12 and FLKV34FIT180) Connect the Whistle-Free Flex Line to the Flared Fitting previously attached to the coupling on the bottom of the aluminum plate.

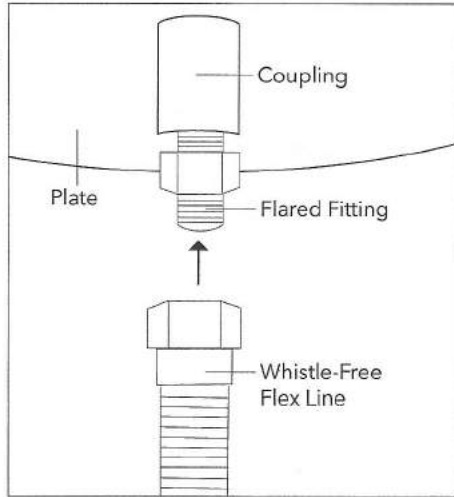

5. Locate 2nd Flared Fitting and Connect to Key Valve

(FLKV12 and FLKV34FIT180) Locate the second Flared Fitting removed in Step 2 and connect into the Key Valve, placing the non-flared end into the key valve. Tighten.

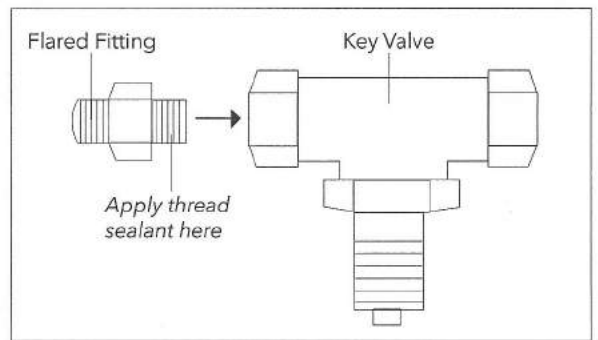

6. Connect Flex Line with Key Valve

(FLKV12 and FLKV34FIT180) Connect the Whistle-Free Flex Line to the Flared Fitting that is now connected to the Key Valve. Connect Escutcheon Plate to Key Valve through vessel wall. Tighten.

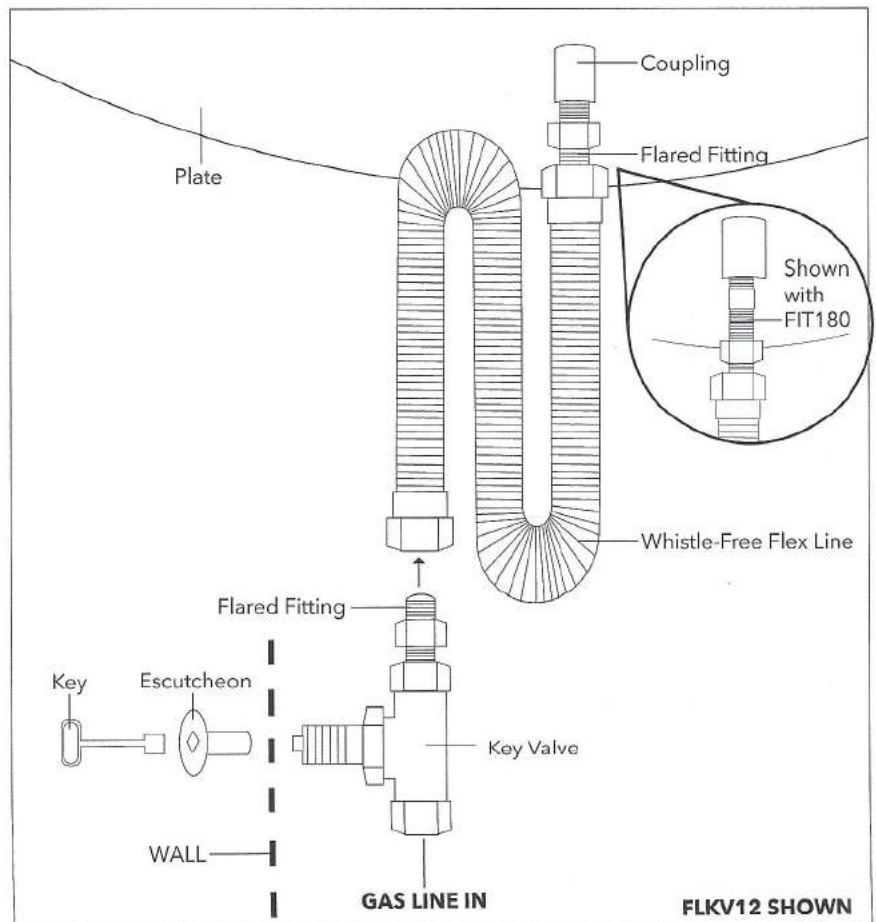

MATCH LIT SYSTEM CONNECTION DIAGRAMS

250K - 299K BTU Systems

250K - 299K WITH DFLKV34FIT250 (Follow steps 1 - 6)

250K - 299K WITH DFLKV34FIT300 (Follow steps 1 - 6, including 3A)

1. Locate DFLKV34 and FIT250 OR DFLKV34 and FIT300

Parts include two Whistle-Free Flex Lines, key valve, escutcheon plate, keys, and FIT250 Kit (DFLKV34FIT250 ONLY) or FIT300 Kit (DFLKV34FIT300 ONLY)

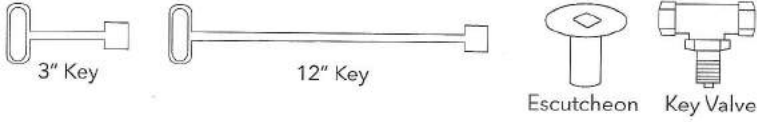

FIT250 Kit: (1) $\frac{3}{4}$ " x 3" Nipple,
(1) $\frac{3}{4}$ " x $\frac{1}{2}$ " MM Reducer Fitting,
(2) $\frac{3}{4}$ " Tees
Included with DFLKV34FIT250 ONLY

FIT300 Kit: (2) $\frac{3}{4}$ " x 3" Nipple,
(2) $\frac{3}{4}$ " Tees
Included with DFLKV34FIT300 ONLY

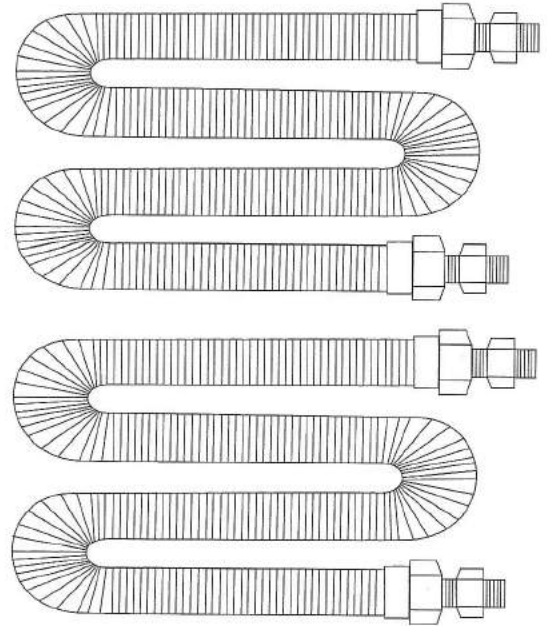

Whistle-Free Flex Lines

2. Remove Flared Fittings from Whistle-Free Flex Lines

(DFLKV34FIT250 and DFLKV34FIT300) Removing flared fittings first makes attaching to FIT250 or FIT300 easier.

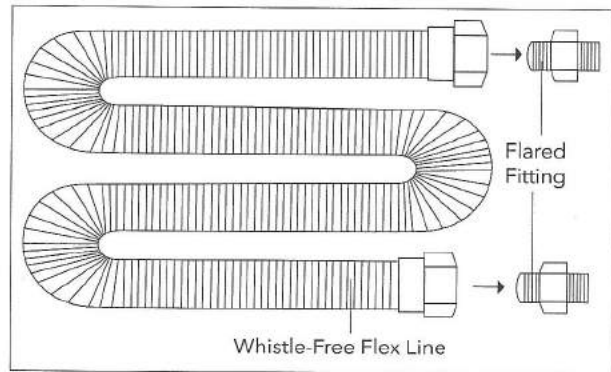
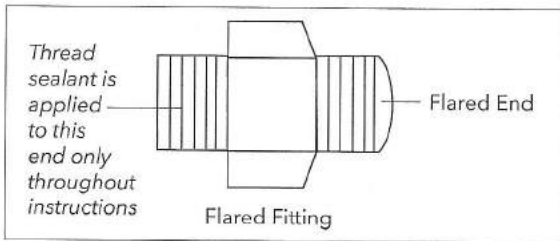

3. Connect FIT250 to Coupling

(DFLKV34FIT250)

Connect $\frac{1}{2}$ " x $\frac{3}{4}$ " Reducing Fitting to $\frac{1}{2}$ " Coupling located on the bottom of the aluminum plate. Then connect $\frac{3}{4}$ " Tee to $\frac{1}{2}$ " x $\frac{3}{4}$ " Reducing Fitting.

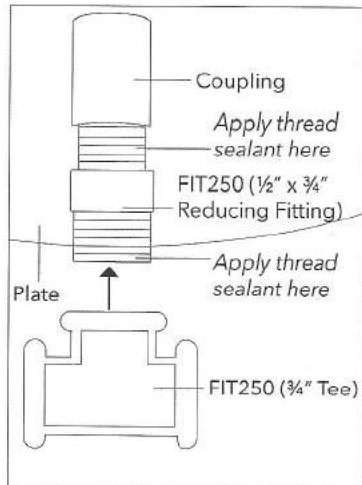

3A. Connect FIT300 to Coupling

(DFLKV34FIT300)

Connect $\frac{3}{4}$ " x 3" Nipple to $\frac{1}{2}$ " Coupling located on the bottom of the aluminum plate. Then connect $\frac{3}{4}$ " Tee to $\frac{3}{4}$ " x 3" Nipple.

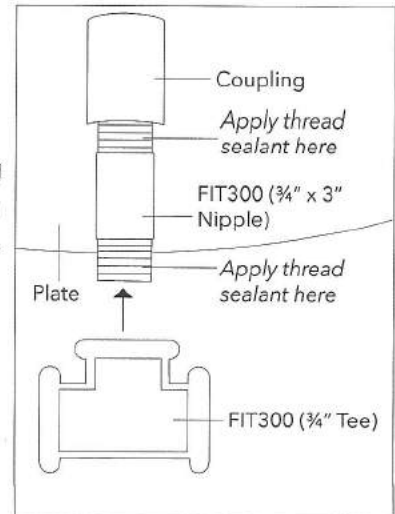

4. Connect Flared Fittings to 3/4" Tee
 (DFLKV34FIT250 and DFLKV34FIT300)
 Connect Flared Fittings to 3/4" Tee.

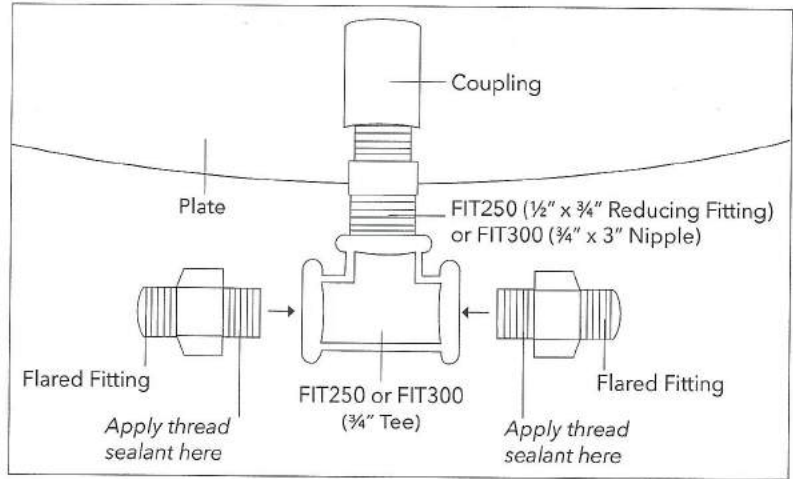

5. Connect FIT Kit to Key Valve and Flared Fittings
 (DFLKV34FIT250 and DFLKV34FIT300)
 Connect 3/4" x 3" Nipple (FIT250 and FIT300) to Key Valve.
 Then connect the 3/4" Tee (FIT250 and FIT300) to the connection just made.
 Connect 3/4" Flared Fittings to the 3/4" Tee.

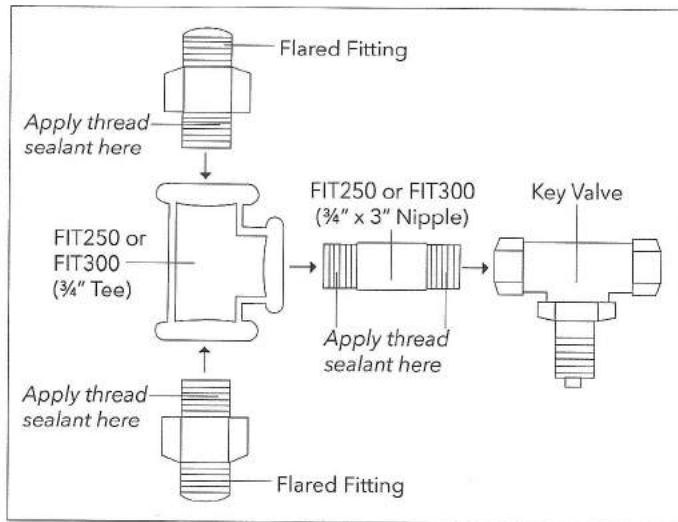

6. Connect Flex Lines to Coupling and Key Valve Connection
 (DFLKV34FIT250 and DFLKV34FIT300)
 Connect ends of 3/4" Whistle-Free Flex Lines to Flared Fittings connected to the aluminum plate and Coupling.
 Then connect available ends of the Whistle-Free Flex Lines to the Key Valve Connection.
 Connect Escutcheon Plate to Key Valve through vessel wall. Tighten.

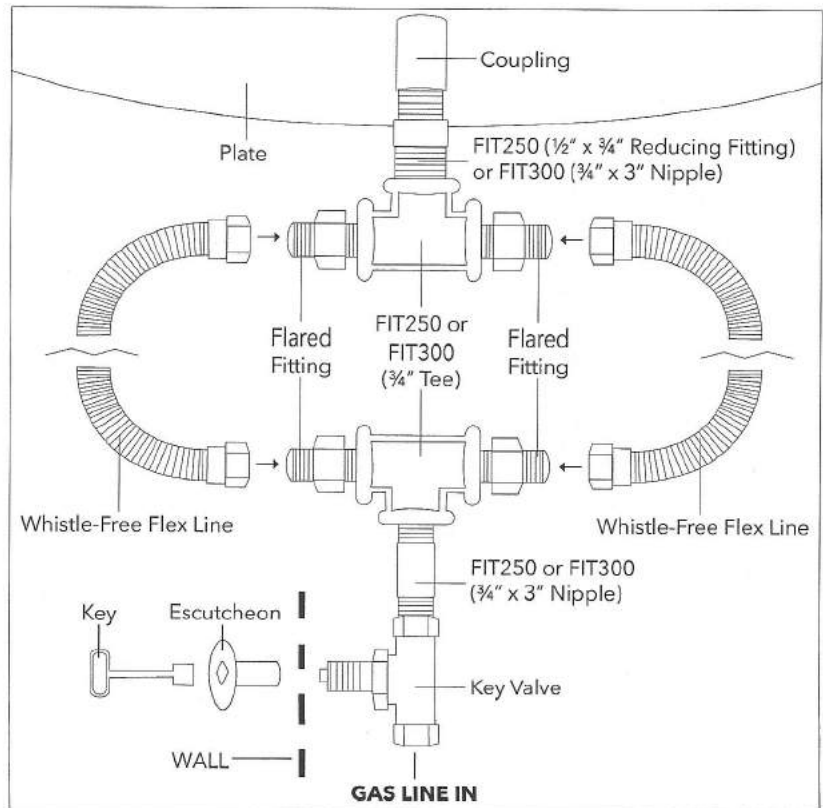

24 VOLT ELECTRONIC IGNITION SYSTEM CONNECTION DIAGRAMS

60K - 249K BTU Systems

60K - 120K WITH FLKV12 (Follow steps 1 - 6)

121K - 249K WITH FLKV34FIT180 (Follow steps 1 - 6, including 3A)

1. Locate FLKV12

Parts include Whistle-Free Flex Line, key valve, escutcheon plate, keys, and FIT180 (FLKV34FIT180 ONLY)

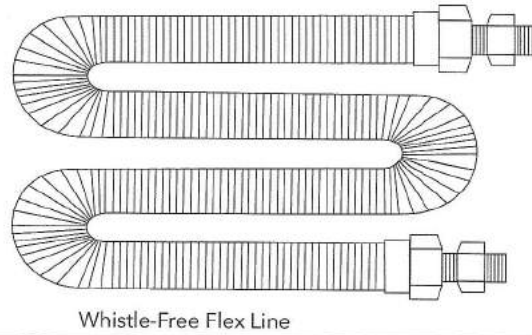
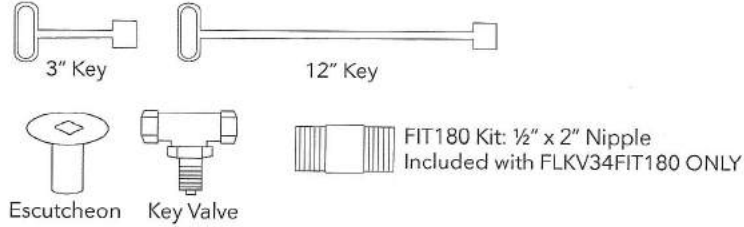

2. Remove Flared Fittings from Whistle-Free Flex Lines

(FLKV12 and FLKV34FIT180) Removing flared fittings first makes attaching to coupling (FLKV12) or FIT180 (FLKV34FIT180) easier.

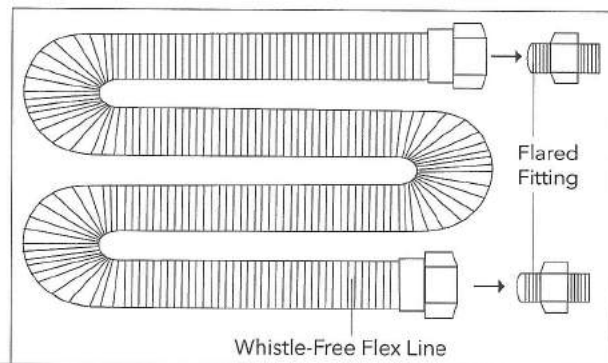
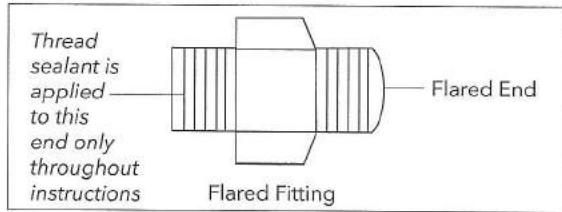

3. Connect to Coupling

(FLKV12) Connect one 1/2" Flared Fittings removed in Step 2 to Gas Valve.

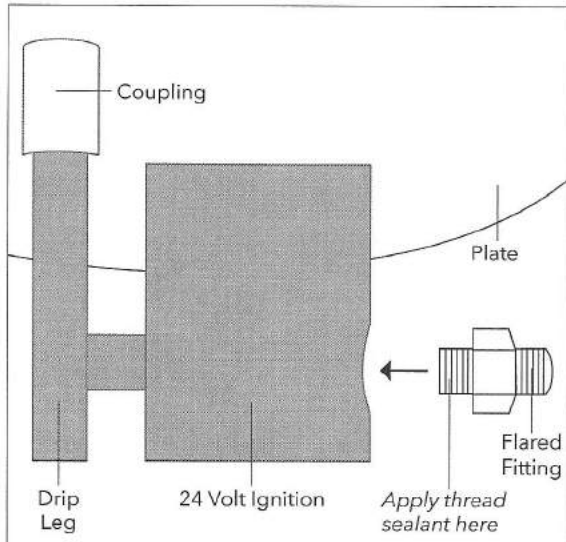

3A. Connect to FIT180, then to Coupling

(FLKV34FIT180) Connect one 1/2" Flared Fitting removed in Step 2 to FIT180 fitting provided by inserting FIT180 into interior threads of the Flared Fitting. Tighten.

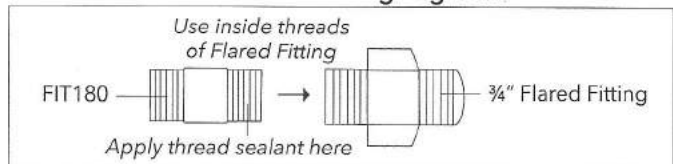

Then, connect the FIT180 fitting to Gas Valve.

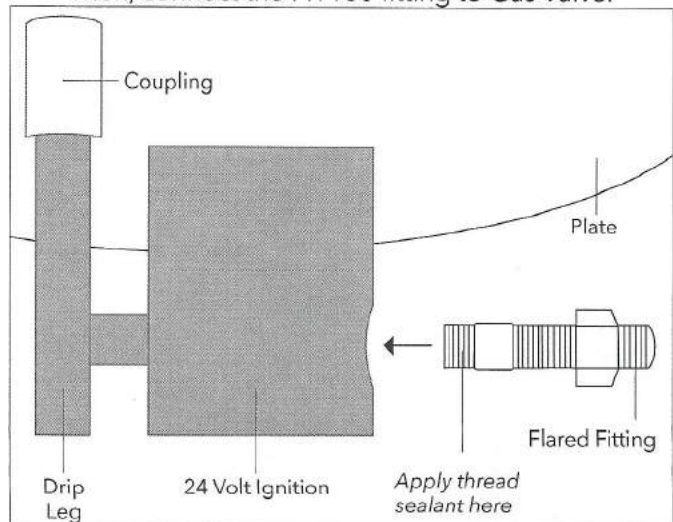

4. Locate 2nd Flared Fitting and Connect to Key Valve

(FLKV12 and FLKV34FIT180) Locate the other Flared Fitting removed in Step 2 and connect into the Key Valve, placing the non-flared end into the key valve. Tighten.

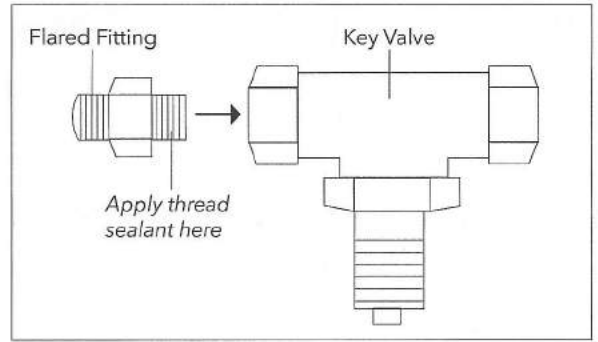

5. CONNECT FLEX LINE TO IGNITION AND KEY VALVE

(FLKV12 and FLKV34FIT180) Connect Whistle-Free Flex Line to Flared Fitting connection at ignition and then to Key Valve/ FIT180 connection in Step 5. Connect Escutcheon Plate to Key Valve through vessel wall. Tighten.

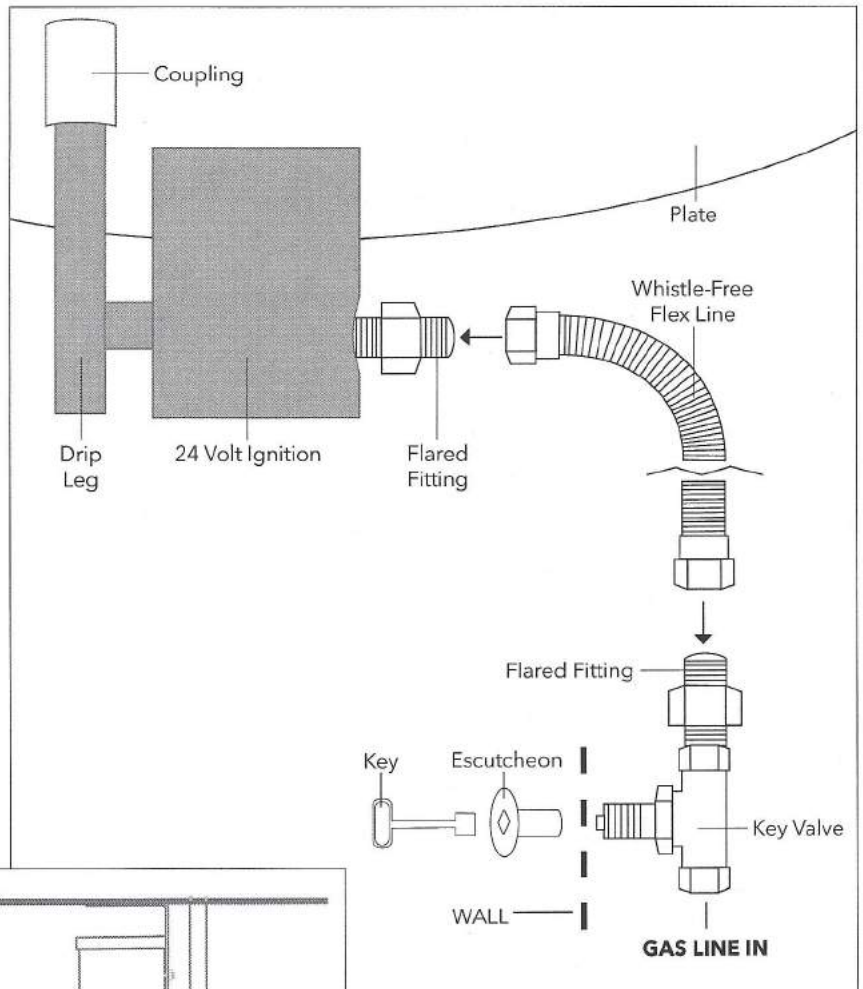

6. CONNECT ELECTRICITY

(FLKV12 and FLKV34FIT180) Plug ignition into three prong, above grade, NEMA Rated, outdoor specific GFCI electrical outlet or have electrician hardware ignition into transformer.

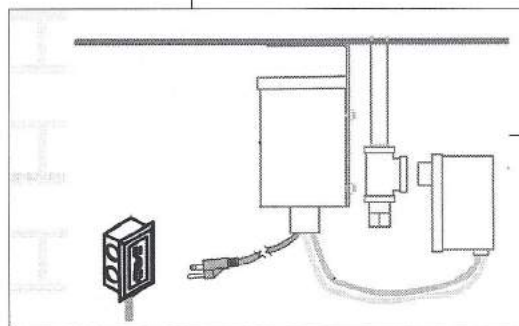

24 VOLT ELECTRONIC IGNITION SYSTEM CONNECTION DIAGRAMS

250K - 290K BTU Systems

250K - 299K WITH DFLKVFIT250 (Follow steps 1 - 8)

300K+ WITH DFLKVFIT300 (Follow steps 1 - 8, including 3A)

1. Locate DFLKV34 and FIT250 OR DFLKV34 and FIT300

Parts include two Whistle-Free Flex Lines, key valve, escutcheon plate, keys, and FIT250 Kit (DFLKV34FIT250 ONLY) or FIT300 Kit (DFLKV34FIT300 ONLY)

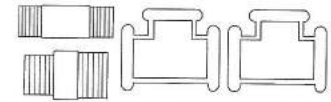
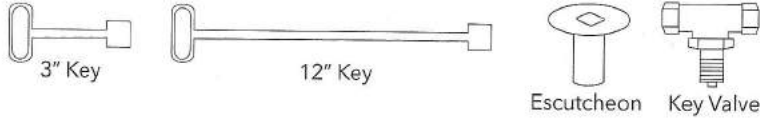

FIT250 Kit: (1) 3/4" x 3" Nipple,
(1) 3/4" x 1/2" MM Reducer Fitting,
(2) 3/4" Tees
Included with DFLKV34FIT250 ONLY

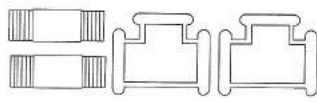

FIT300 Kit: (2) 3/4" x 3" Nipple,
(2) 3/4" Tees
Included with DFLKV34FIT300 ONLY

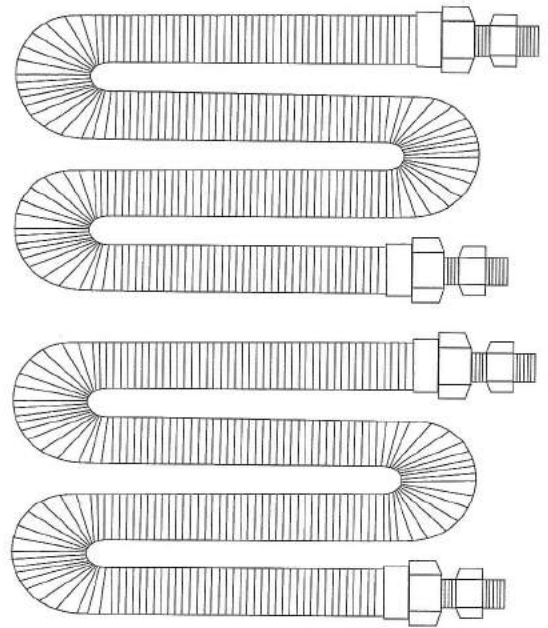

Whistle-Free Flex Lines

2. Remove Flared Fittings from Whistle-Free Flex Lines

(DFLKV34FIT250 and DFLKV34FIT300) Removing flared fittings first makes attaching to FIT250 or FIT300 easier.

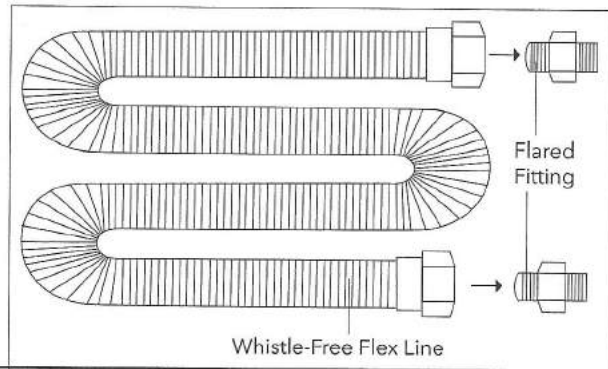
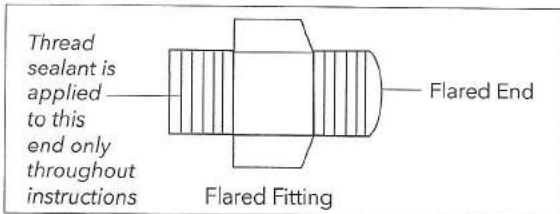

3. Connect to Coupling

(DFLKV34FIT250) Connect 1/2" x 3/4" Reducing Fitting to Gas Valve

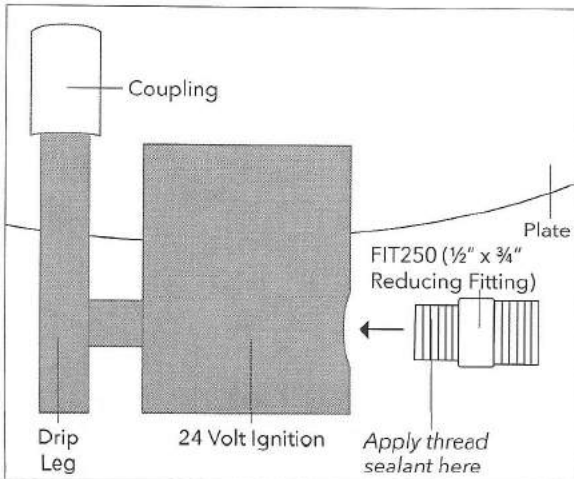

3A. Connect to Coupling

(DFLKV34FIT300) Connect 3/4" x 3" Nipple to Gas Valve

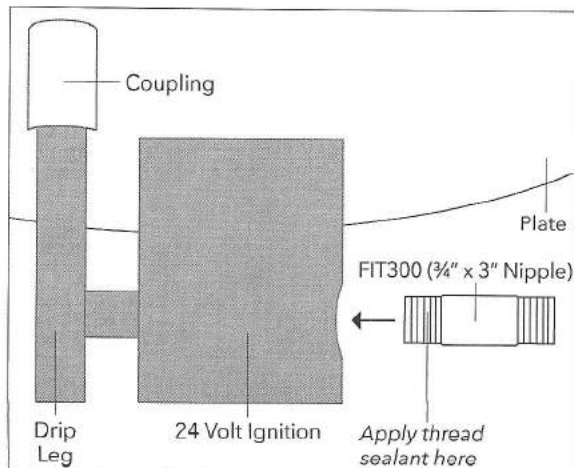

4. Connect Flared Fittings to 3/4" Tee

(DFLKV34FIT250 and DFLKV34FIT300) Connect 3/4" Tee to 1/2" x 3/4" Reducing Fitting (FIT250) or 3/4" x 3" Nipple (FIT300.) Then connect Flared Fittings to 3/4" Tee.

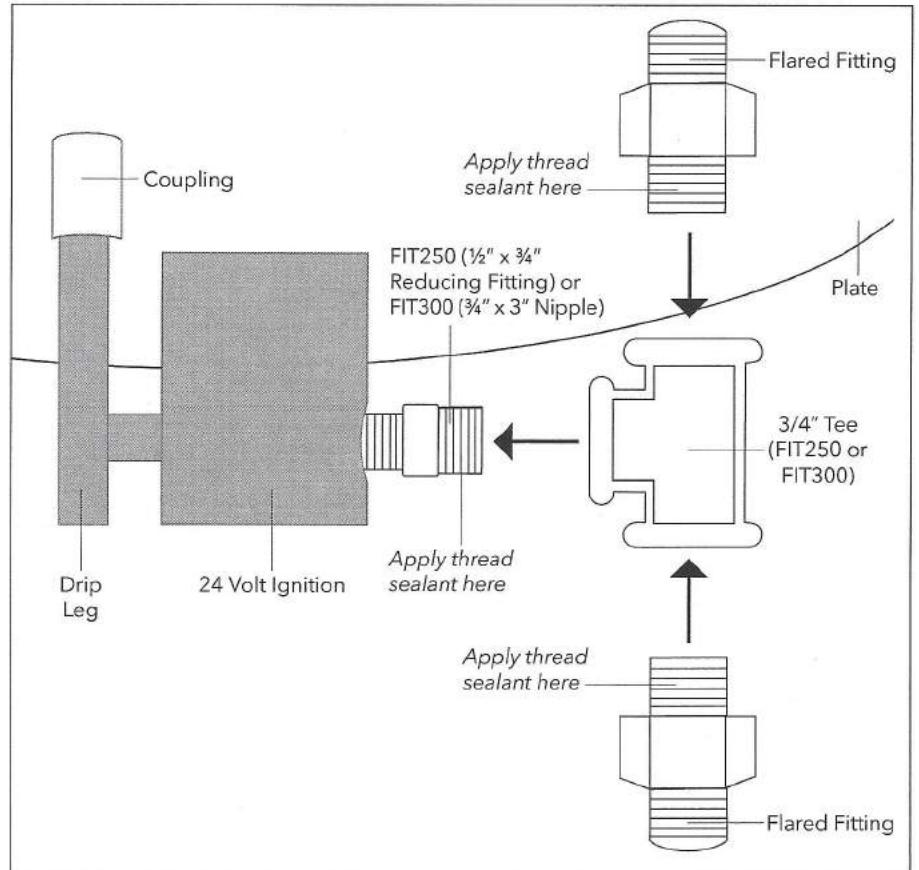

5. Connect Flex Lines to Tee

(DFLKV34FIT250 and DFLKV34FIT300)

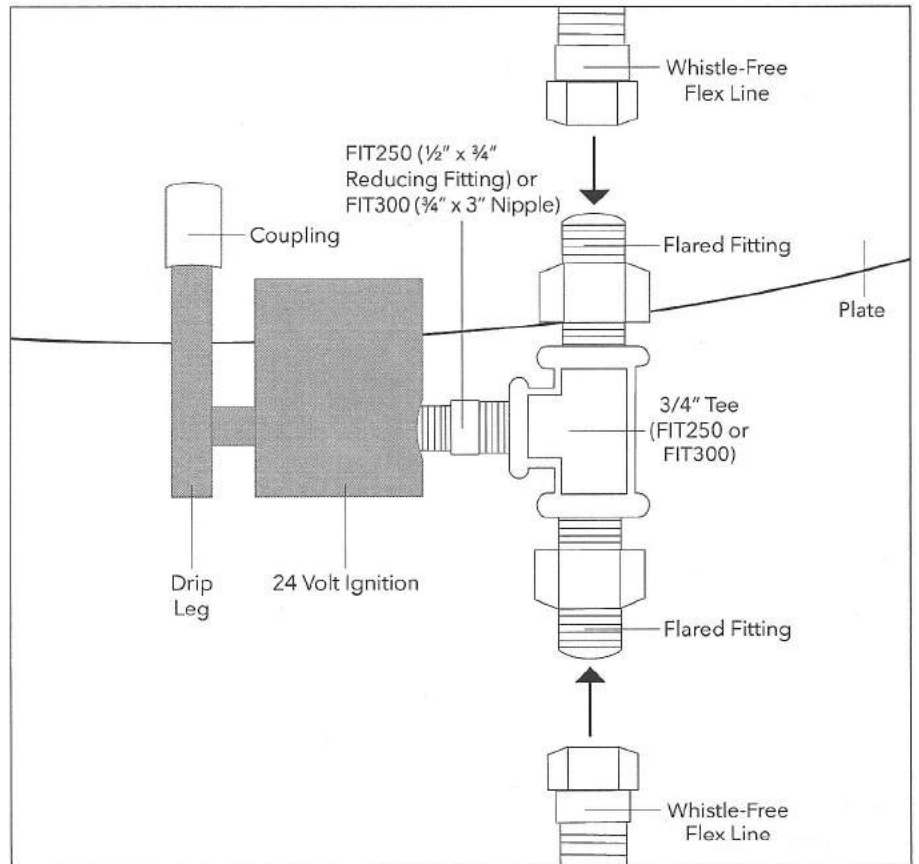

6. Connect FIT Kit to Key Valve and Flared Fittings

(DFLKV34FIT250 and DFLKV34FIT300)

Connect 3/4" x 3" Nipple (FIT250 and FIT300) to Key Valve.

Then connect the 3/4" Tee (FIT250 and FIT300) to the connection just made.

Connect 3/4" Flared Fittings to the 3/4" Tee.

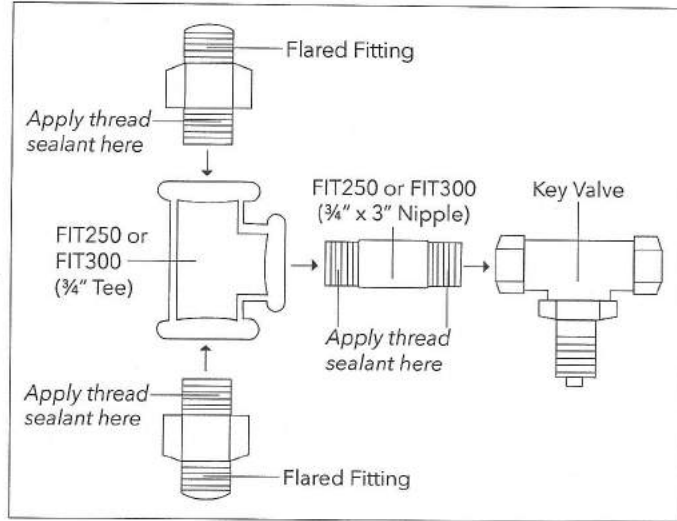

7. Connect Flex Lines to Coupling and Key Valve Connection

(DFLKV34FIT250 and DFLKV34FIT300)

Connect ends of 3/4" Whistle-Free Flex Lines to Flared Fittings connected to the 24 Volt Ignition. Then connect available ends of the Whistle-Free Flex Lines to the Key Valve Connection. Connect Escutcheon Plate to Key Valve through vessel wall. Tighten.

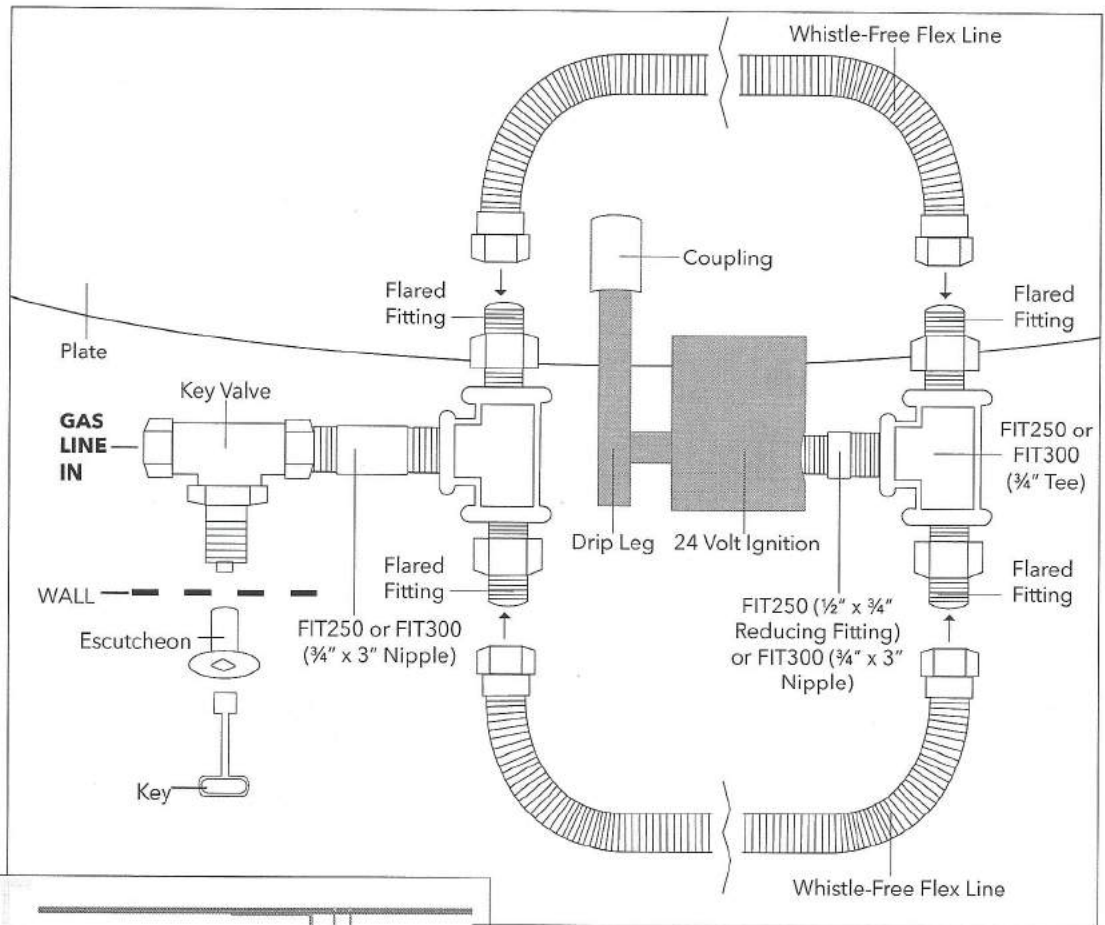

8. CONNECT ELECTRICITY

(FLKV12 and FLKV34FIT180)

Plug ignition into three prong, above grade, NEMA Rated, outdoor specific GFCI electrical outlet or have electrician hardware ignition into transformer.

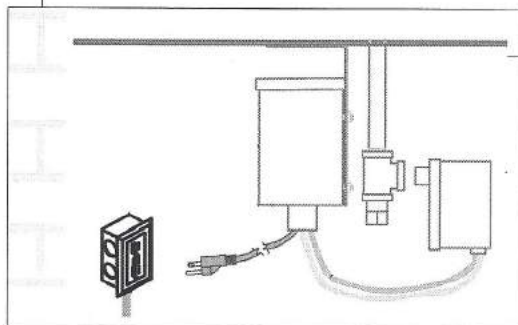

PUSH BUTTON IGNITION SYSTEM CONNECTION DIAGRAMS

Up to 300K BTU Systems

1. Install Push Button Module into Mountin Bracket

- Unscrew Button Cover.
- Remove plastic Nut.
- Insert Washer #1.
- Insert Washer #1 onto the button stem.
- Insert Push Button Stem

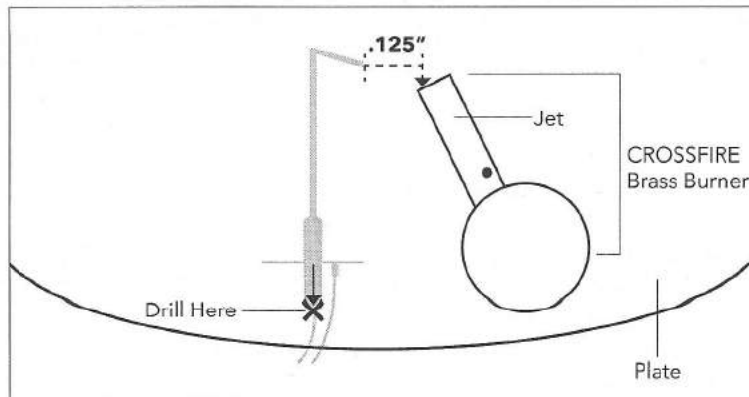

2. Install Push Button Module into Mountin Bracket

- Unscrew Button Cover.
- Remove plastic Nut.
- Insert Washer #1.
- Insert Washer #1 onto the button stem.
- Insert Push Button Stem through mounting bracket hole.
- Insert Washer #2.
- Put on plastic Nut and turn until Push Button Control has been secured to mountin bracket.
- Insert AA Battery into Button Stem.
- Screw on Button Cover.

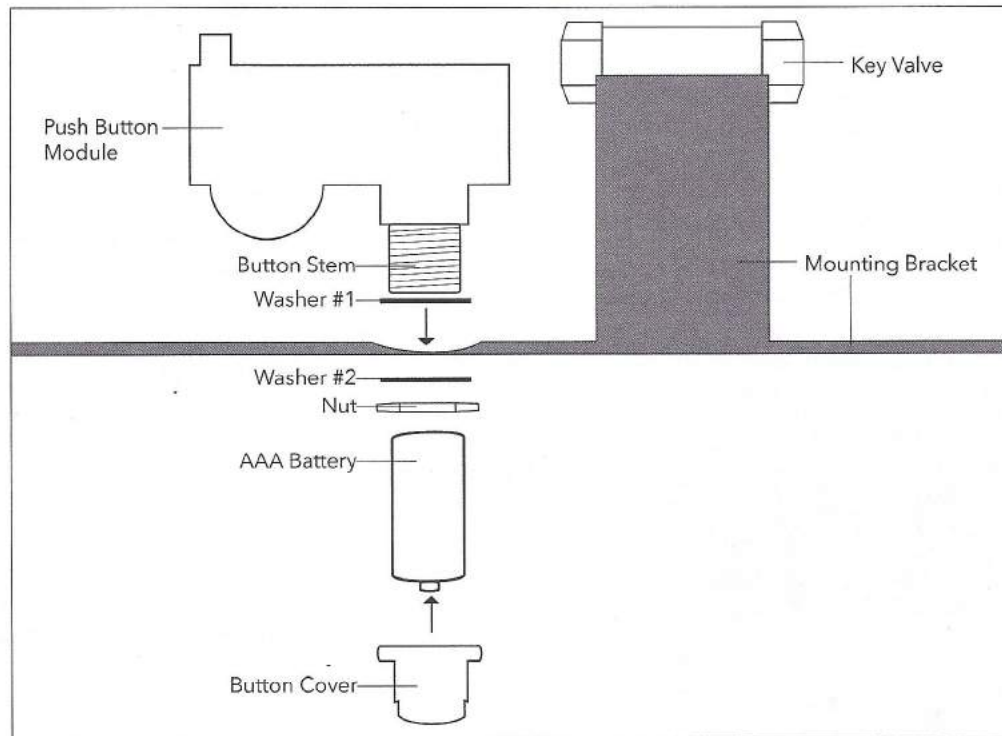

3. Connect Spark Igniter Wires

- Crimp Spark Igniter Wires, then slide crimped wires on to connections using needle nose pliers. Be careful not to break connectors. Wires can go in either connection.

4. Test without Gas

- Test Spark Igniter and Push Button Module WITHOUT gas, making sure spark arcs from electricity to jet.

5. Test with Gas

- Burner should light within 5 seconds or a few clicks.

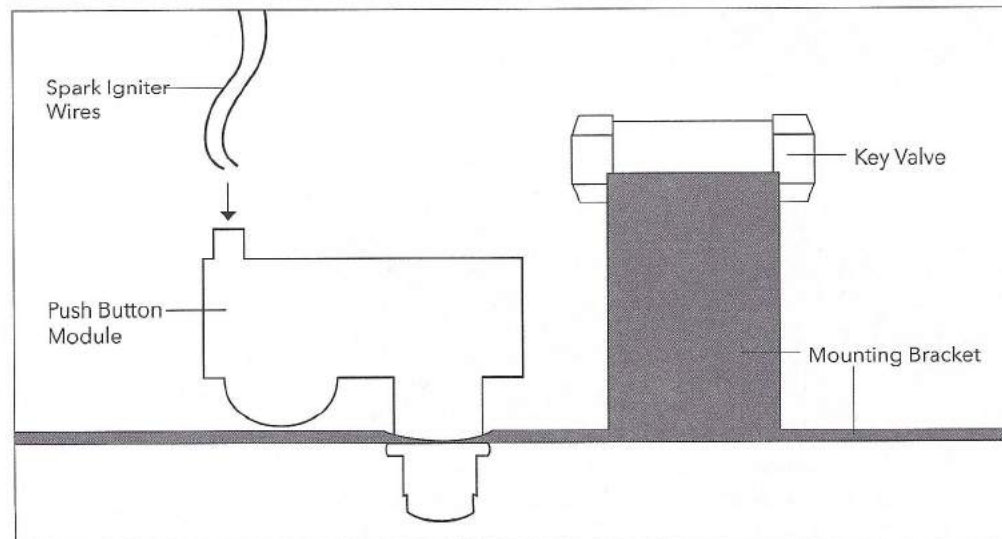

MEDIA INSTALLATION

Only use approved decorative media (glass, lava rock, ceramic log sets, etc.) that have been manufactured for specific use in fire features.

Media must be 1/2" or larger in size to prevent media from falling into gas orifices and blocking flow of gas out of jets. Use approved media only. To avoid dust and clogs getting into the system, do not dump the media over the burner. Place the media onto the plate or pan.

Burner should be covered by approved media up to 1/2" above the jets. Media may be positioned so that jet tips or barrels are visible. PLEASE NOTE - covering jets by more than 1/2" of media may create back pressure and gas leakage resulting in pooling of gas under the fire feature which can result in explosion which could cause property damage, personal injury, or death. Also note that flame pattern will be affected by any media coverage over gas orifice jets up to and including smothering of flames.

When using electronic ignition systems please pay particular attention to keeping media away from the pilot assembly area and/or away from wind screen of pilot assembly. Incorrect media installation that blocks pilot assembly will cause the pilot flame to stifle, blocking of thermal sensor and/or a delay in main burner ignition.

The appliance is designed to use approved media that is correctly installed over the burner to achieve proper combustion. Use of any media outside of the approved media may void warranty and affect proper operations.

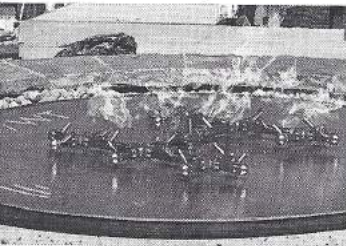

Install enclosure and fire feature per instructions provided by manufacturer.

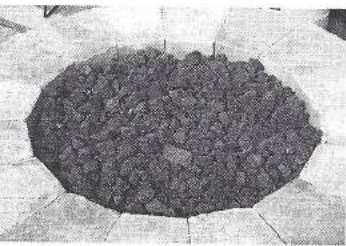

DO NOT DUMP MEDIA ON THE JETS. Apply media by pouring media around burner first, then pushing media towards the gas jet orifices making sure media does not fall into the gas jet orifices. Check each gas jet

orifice prior to lighting to be sure no media has fallen into gas jet orifices.

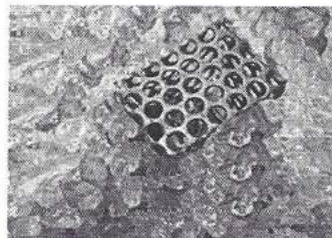
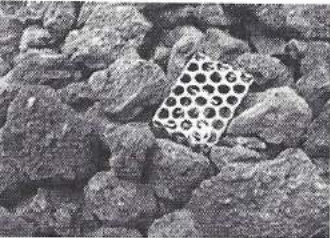

For All Electronic Ignition Systems: Keep pilot assembly screen free and clear of all media. Media should be piled no more than halfway up screen only (not over full amount of screen) so that pilot gas orifice opening is above media coverage allowing for pilot flame to easily reach gas jet orifice.



For Ceramic Log Sets: Place logs on top of lava rock base according to preference and desired flame pattern. For electronic ignition systems - do not block, cover or obstruct pilot assembly.

Blocking, covering or placing ceramic logs too close to pilot may cause excessive heat on pilot causing system to fail. This is not covered under warranty.

OPERATING INSTRUCTIONS

Keep the area clear and free from combustible materials, gasoline, and other flammable vapors and liquids.

Solid fuels shall not be burned in the fire pit. Leaves, sticks, wood, paper, clothing, food material, should be kept away from the fire pit. Make sure that there is no vegetation or other objects over the top or sides of the fire pit that could interfere with safe operation. If there are any questions as to clearances, refer to CLEARANCES DIAGRAM in your Installation Manual for specific clearance allowances.

Wind and gusty conditions may cause the flame to behave in an unpredictable manner. If conditions exist, turn off the fire feature.

All media (lava rock, volcanic stone, fire glass, etc.) has the potential of thermal spalling. This process may occur when media is wet and moisture gets trapped inside of the material due to rapid temperature differences. When this happens the media has the potential to crack or pop outside of the fireplace. Extra caution should be taken when lighting in high humidity or moisture. After igniting, allow 30 minutes to dry out the media, and monitor from a distance until all popping has ceased before fully enjoying the fire.

TURNING ON YOUR MATCH LIT SYSTEM

- 1. STOP!** Read all the safety information.
- Any cover must be removed prior to operation of burner or appliance and must remain off during operation. **Danger: Fire or Explosion Hazard. If you smell gas, shut off gas to the appliance, extinguish any open flame. If odor continues, leave the area immediately. After leaving the area, call your gas supplier or fire department. Failure to follow these instructions could result in fire or explosion, which could cause property damage, personal injury or death.**
- Confirm that your main Natural Gas or Liquid Propane supply to the appliance is open. **Do not open your key valve or gas control valve at this time.**
- Before lighting, visually inspect fire feature and remove any accumulated leaves or other combustible debris.
- Locate key valve or gas control valve controlling gas supply to your appliance.
- Locate the closest jet tip on the exterior of the burner that can be easily accessed while operating key valve or gas control valve without reaching across other jets

- or the burner.
7. Place a lit lighter or match flame on or slightly above the tip of the jet located in Step 6 while not reaching over it. A long reach lighter or match is recommended.
 8. While holding the flame on or slightly above the jet tip as described in Step 7 above, slowly turn the key valve or gas control knob to the left to allow a minimal flow of gas to the burner and light the selected jet. While attempting to light jet, do not substantially increase gas supply. Excessive flow of gas before jet is lit can cause pooling of gas and result in sudden flare up. **Failure to follow these instructions could result in fire or explosion, which could cause property damage, personal injury or death.**
 9. Once the selected jet (or other jets) is lit, continue to keep any body parts from above the pit or burner and slowly turn the key valve or gas control knob further to the left to increase the flow of gas to the burner. The other jets of the burner should ignite.
 10. You may follow the same procedure described above to light additional jets only if able to do so without reaching across the burner or other jets which may ignite.
 11. If the flame will not stay lit after several attempts, turn the key valve to the off position and call your local technician or gas supplier for service prior to re-attempting to operate your appliance.
 12. Once lit, use the key valve to adjust the flame to the desired height.

TURNING OFF YOUR MATCH LIT SYSTEM

1. Use key to turn valve to OFF position by turning key to the right.
2. Verify flame is OUT.
3. If using LP bottle/tank - turn bottle/tank to CLOSED position.
4. Allow to cool completely, then cover the fire feature with water proof/ weather proof cover.

TURNING ON YOUR ELECTRONIC IGNITION SYSTEMS

WARNING: For electronic ignition models requiring power supply - a qualified, licensed electrician must install power supply. An outdoor NEMA rated GFCI Receptacle outlet should be installed within the interior of the enclosure above grade to supply power to system.

1. **STOP!** Read all the safety information and warnings in the Installation Manual before attempting to light fire feature.
2. Any cover must be removed prior to operation of burner and must remain off during operation.
Danger: Fire or Explosion Hazard. If you smell gas, shut off gas to the appliance, extinguish any open flame. If odor continues, leave the area immediately. After leaving the area, call your gas supplier or fire department. Failure to follow these instructions could result in fire or explosion, which could cause property damage, personal injury or death.
3. Confirm that your Natural Gas or Liquid Propane supply to the appliance is open or on.
4. Before lighting, visually inspect fire feature and remove any accumulated leaves or other combustible debris.
5. If you do not smell gas, use the key to turn the key valve or gas control valve to the ON position by turning the key to the left.

6. Turn on power to the fire feature with switch, button, or remote. Within 10 seconds of power application Pilot Flame should be lit and visible. Once the pilot is lit, the main burner will ignite shortly after. For Push Button: Press push button ignition and listen for clicking noise which indicates electrode is firing. Gas should ignite after a few clicks.
7. Use key valve to adjust flame to desired height.

TURNING OFF YOUR ELECTRONIC IGNITION SYSTEMS

1. Turn off power to fire feature -with remote control or wall switch.
2. Turn key valve to OFF position by turning key to the right.
3. If using LP bottle/tank - turn bottle/tank to CLOSED position.
4. Verify flame is OUT.
5. After allowing for ample cooling time, cover the fire feature with water proof / weather proof cover.

WARNING: FOR REMOTE CONTROL USE: To prevent unwanted startup turn off power to the appliance when not in use.

WARNING: If fire feature fails to turn off completely (small flames still visible), turn off gas supply using the main valve by your meter, and contact your gas supplier or qualified technician.

WARNING: For electronic ignition systems, which have an extended or detached valve box, the area in which the valve box is installed must conform with all installation requirements, including but not limited to location, construction, venting and local codes. Failure to do so may result in property damage, personal injury, or death.

FIRESTORM® STEEL GAS LOG OWNER INFORMATION AND INSTALLATION

Thank you for your purchase of a FireStorm Steel Gas Log from Warming Trends. We appreciate your business and hope that you enjoy your FireStorm for many years to come!

Burner System Installation and Operating Instructions Please read and follow the entire Warming Trends Owner's Guide and Instruction Manual to install and operate your outdoor gas burner system. **During the installation of your burner system, for safe lighting, orient the burner so that one end of it is easily reachable while operating the key valve.**

Please follow all instructions of this Owner's Manual regarding the use of approved media coverage over the burner. The approved media will form a bed upon which to place the FireStorm Steel Gas Log. It is recommended that a flat bed of media two inches wider and longer than the FireStorm Steel Gas Log be formed.

INSTALLATION OF THE FIRESTORM STEEL GAS LOG

Once your approved media has been installed, place your FireStorm Steel Gas Log over the burner so that the burn-

er is centered underneath it. Your steel log has a "lighting opening" at each end to aid in lighting the burner. (See Figure 1 below). Orient the steel log so that one end of the log is near the key valve. Press down upon the log to seat the log in the media to create a level and stable foundation. Adjust media as necessary.

Adjust your media so that the tip of the jet nearest the end of the log to be used for lighting is exposed. Use this jet for lighting the burner pursuant to Steps 6 and 7 below.

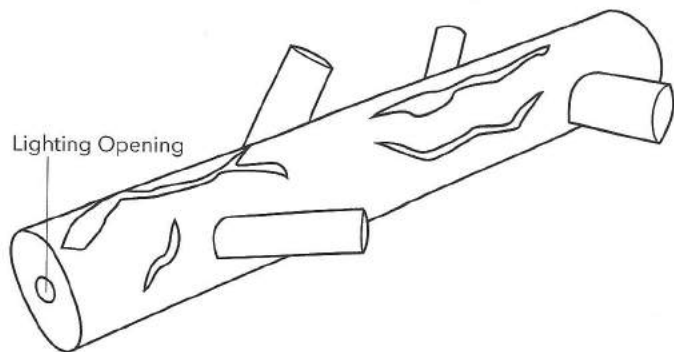

LIGHTING AND TURNING OFF YOUR MATCH LIT FIRESTORM STEEL GAS LOG SYSTEM

These instructions supplement the Lighting Instructions within your Owner's Manual related to Turning On Your Match Lit System. Light your FireStorm Steel Gas Log using a "lighting opening" to access your burner as described below.

TURNING ON YOUR MATCH LIT SYSTEM

1. **STOP!** Read all the safety information.
2. Any cover must be removed prior to operation of burner or appliance and must remain off during operation. **Danger: Fire or Explosion Hazard. If you smell gas, shut off gas to the appliance, extinguish any open flame. If odor continues, leave the area immediately. After leaving the area, call your gas supplier or fire department. Failure to follow these instructions could result in fire or explosion, which could cause property damage, personal injury or death.**
3. Confirm that your main Natural Gas or Liquid Propane supply to the appliance is open. **Do not open your key valve or gas control at this time.**
4. Before lighting, visually inspect fire feature and remove any accumulated leaves or other combustible debris.
5. Locate key valve or gas control valve controlling gas supply to your appliance.
6. **Locate the jet tip nearest the "lighting opening" described above** that can be easily accessed while operating key valve or gas control without reaching across other jets or the burner. Reorient burner if necessary to allow such access.
7. Place a long reach lighter through the "lighting opening" of the gas log slightly above or on the tip of the jet located in Step 6 above. (See Figure 1). Do not use a match or cigarette lighter.
8. While holding the flame on or slightly above the jet tip as described in Step 7 above, **slowly** turn the key valve or gas control knob **slightly** to the left to allow a minimal flow of gas to the burner and light the selected jet. While attempting to light jet, do not substantially increase gas supply. Excessive flow of gas before jet is lit can cause pooling of gas and result in

sudden flare up. **Failure to follow these instructions could result in fire or explosion, which could cause property damage, personal injury or death.**

9. Once the selected jet (or other jets) is lit, continue to keep any body parts from above the pit or burner and slowly turn the key valve or gas control knob further to the left to increase the flow of gas to the burner. The other jets of the burner should ignite.
10. If the flame will not stay lit after several attempts, turn the key valve or gas control to the off position and call your local technician or gas supplier for service prior to re-attempting to operate your appliance.
11. Once lit, use the key valve or gas control to adjust the flame to the desired height.

TURNING OFF YOUR MATCH LIT BURNER

1. Use key to turn valve to OFF position by turning the valve to the right.
2. Verify flame is OUT.
3. If using LP bottle/tank, turn bottle/tank to CLOSED position.
4. Allow to cool completely, then cover the fire feature with water proof/ weather proof cover.

APPEARANCE

Your steel log should patina over time by forming a layer of rust or oxidation. The coloring may change and the log will look more natural. Each log develops a unique patina pattern based upon use and weather conditions. Heat will also create distinctive color changes to your log's surface.

CLEANING STEEL LOG

Soot may build up along the openings in the log or on its surface in general. Annual cleaning is recommended. However, if soot restricts or reduces normal flame performance, clean openings immediately. **Prior to any cleaning, wait for log to cool completely and then remove the log from the system.** Soot is then easily removed by spraying the log with water or by lightly brushing with a plastic brush. Do not allow water or soot to fall into burner system.

GENERAL MAINTENANCE

WARNING:

Fire feature should be inspected by user prior to each use and inspected at least once annually by a qualified gas appliance service professional.

Any guard or protective device removed for servicing must be replaced prior to operating the appliance.

Installation and repair should be done by a qualified technician. Appliances should be inspected prior to each use and inspected at least once annually by a qualified gas appliance service professional.

Ensure gas and power (if applicable) are shut off and fire pit is cool before servicing.

Keep fire feature covered at all times when not in use.

Keep any debris out of appliance - clean as needed. If debris is found, remove before lighting system.

JET ORIFICE CLEANING

Annual inspection and cleaning of the fire feature is recommended. If at any time the flames exhibit any abnormal shapes or behavior, or if burner fails to ignite properly, then the burner holes located in bottom of gas jet orifices may require cleaning. The appliance can be cleaned by carefully removing the logs and media to allow access to burner. Use a brush to carefully remove dust, spider webs and loose particles. Periodical inspection by a qualified service technician of the air-intake is required to ensure your fire feature performs properly.

Use a wire or small puncture tool and carefully insert in jet. Tool should be size of a small paper clip. If evidence of damage, burner must be replaced with the appropriate CROSSFIRE™ burner specified by manufacturer.

PILOT ASSEMBLY/THERMOCOUPLE CLEANING OF SOOT

Every six months or as needed, remove media, lava rock, or glass from around the pilot assembly. Clean the thermocouple of any soot using soft brush. Be careful not to damage the igniter element. Be sure when returning your media to the pit to cover your orifices to avoid blocking the jets as mentioned on page 6.

Once pilot assembly is clean, inspect to see flame that covers 3/8" to 1/2" of the thermocouple. Cleaning of pilot gas orifice may be required by removing pilot hood and removing orifice and cleaning out orifices from debris, soot or anything that may be preventing gas flow from exiting the pilot gas orifice.

For Push Button only, visually inspect electrode and jet used for conductivity regularly to make sure it is free of debris and soot. Soot build up or obstructions of any kind can reduce effectiveness of spark. Without a strong spark, burner will not light. If spark is not strong enough, clean off / remove any soot from jet and, using fine grit sand paper, gently remove any rust from electrode. If spark is still not strong enough to light burner, check / replace batteries. If new batteries don't fix the problem, replace the spark electrode.

TROUBLESHOOTING

MATCH LIT / PUSH BUTTON

Below are some potential causes and countermeasures to the symptoms listed:

- No flame - Make sure the key valve is on. Turn key to the left to open valve and allow gas flow.
- Low or Weak Flame - Verify correct gas pressure using the Water Column Pressure Chart.
- One or more jets will not light - Clean the orifices and check jets for obstruction.
- Fire feature is making a whistling sound - Make sure that the flex line is the whistle-free, without sharp bends, and installed correctly. Check the pressure to be sure it is within recommended ranges.
- Contact a certified gas technician for service & repair if these suggestions do not solve the issue.

ELECTRONIC IGNITION SYSTEMS

Below are some potential causes and countermeasures to the symptoms below.

- No Pilot Flame - Pilot sparks or glow plug glows but pilot won't light.
 - Air in the gas line. If this is a new install it may take several attempts to purge the air.
 - Debris is in the gas line. Clear the gas line.
 - Water/Moisture is in the gas line. Clear the gas line.
 - Incorrect Gas pressure. Confirm proper gas pressure.
 - Pilot gas orifice is dirty. Remove the pilot head and clean.
 - Electrical current is not strong enough to support igniter - either spark on spark igniter isn't strong enough to ignite pilot flame (3V or Spark Igniter) or glow plug is not getting hot enough to ignite pilot flame (Hot Surface Igniter).
 - Improperly applied media.
 - Wind conditions might be too severe.
- No Main Burner - Pilot Lights but main burner will not light.
 - Gas pressure is incorrect. Confirm proper gas pressure.
 - Small pilot flame. Remove the pilot head and clean pilot gas orifice.
 - Dirty thermal sensor. Clean using soft brush.
 - CROSSFIRE™ BURNER has an obstruction. Confirm there is no debris blocking gas orifice jets in main burner, purge water and air from gas lines or in the burner, confirm there is no debris in gas lines.
- Main Burner Turning On and Off Intermittently
 - Small pilot flame. Remove the pilot head and clean as described in the maintenance section.
 - Improperly applied media - Make sure your media is not covering the pilot assembly and that your logs are not placed over or too near the wind cage.
 - Gas pressure is incorrect - Confirm proper gas pressure by checking at the gas stub to the pit and the Water Column Pressure Table
 - Thermal sensor is dirty or defective - Gently clean thermal sensor, or change the pilot assembly.
 - Wind conditions - Confirm the burner is properly located 4-6" inside the pit, and be sure the wind conditions are not too severe for safe use.
 - Fire Feature is Making a Whistling Sound - Make sure that the flex line is the correct size and that there are no kinks or tight bends in the line. If the whistling sound is coming from the jets, please check your pressure against the Water Column Pressure Table in this manual to make sure it is within recommended ranges. Adjust as needed.

Please contact your retailer or certified technician for service & repair if these suggestions do not solve the issue. If replacement parts are required - contact your retailer or licensed technician for authorized replacement parts. Warranty is null and void if unauthorized parts are used.

WARRANTY

ALL CROSSFIRE BRASS BURNERS HAVE A LIMITED LIFETIME WARRANTY.

ALL WARMING TRENDS STEEL LOG SETS PURCHASED ON OR AFTER JANUARY 1, 2019, HAVE A LIMITED TEN (10) YEAR WARRANTY. ALL WARMING TRENDS FIRESTORM STEEL LOG SYSTEMS HAVE A LIMITED SEVEN (7) YEAR WARRANTY.

ALL BURNERS AND ELECTRONICS (IF PRESENT) MUST BE COVERED WHEN NOT IN USE OR WARRANTY IS NULL AND VOID

Warming Trends™ warrants its products to be free from defective material and workmanship under normal service and use. This warranty covers manufacturing defects only and does not cover defects due to normal wear and tear; it does not warrant any product or part that has been altered, accidentally damaged, damaged in shipping, disassembled, modified, misused, neglected, failure to maintain, not installed, or not kept in continuous service after installation. Warming Trends™ liability shall be restricted to the purchase price of the product only and makes no other warranty, express or implied, but not limited to, the implied warranties of salability and appropriateness for a specified purpose, with respect to its products and parts, whether used along or in combination with others. Warming Trends™ is free of liability for any damages caused by the unit, as well as inconvenience expenses, material or labor charges incurred by any service call, repair, removal or re-installation of any unit. Incidental or consequential damages are not covered by this warranty. Warranty does not cover damage to systems due to debris in the gas lines or damage to system due to water. Owner is responsible for reading and understanding warranty for full terms and conditions

Warming Trends™, at its discretion, agrees to repair or replace defective product if returned to Warming Trends™ within the warranty period. The respective warranty time periods are effective from the original date of purchase. The warranty is non-transferable and applies only to the original purchaser. In addition, this warranty is automatically void if the unit's serial number has been removed or altered in any way.

IGNITION SYSTEMS WARRANTY

ALL BURNERS AND ELECTRONICS MUST BE COVERED WHEN NOT IN USE OR WARRANTY IS NULL AND VOID

Push Button Ignition Systems: There is no warranty offered on any push button ignition system.

Electronic Ignition Systems - Residential Installations: 24VIK and 3VIK systems are fully warranted for one (1) year with a limited warranty for two (2) years from date of purchase. In the event a system must be replaced due to a defect/malfunction of the system, Warming Trends™ will repair or replace the system at no cost for the first year. In the event a system fails after the first year from date of purchase and within two years from date of purchase, Warming Trends™ will repair or replace the system for a

cost of 50% of the current list price. This warranty does not cover labor costs.

P24VIK systems purchased ON OR BEFORE April 15, 2018 are fully warranted for one (1) year with a limited warranty for two (2) years from date of purchase. In the event a system must be replaced due to a defect/malfunction of the system, Warming Trends™ will repair or replace the system at no cost for the first year. In the event a system fails after the first year and within two years of date of purchase, the cost for a replacement system is at a discount rate of 50% of the current listed price. This warranty does not cover labor costs.

P24VIK Systems purchased AFTER April 15, 2018 are fully warranted for three (3) years from date of purchase. In the event a system must be replaced due to a defect/malfunction of the system, Warming Trends™ will repair or replace the system at no cost for the first three years. This warranty does not cover labor costs.

Electronic Ignition Systems - Commercial Installations:

24VIK and 3VIK systems are fully warranted for twelve months from date of purchase. In the event a system must be replaced due to a defect/malfunction of the system, Warming Trends™ will repair or replace the system at no cost. This warranty does not cover labor costs.

P24VIK Systems are fully warranted for one (1) year from date of purchase. In the event a system must be replaced due to a defect/malfunction of the system, Warming Trends™ will repair or replace the system at no cost for 12 months from the date of purchase. This warranty does not cover labor costs.

Problems in the functioning of the systems due to gas plumbing or electrical installed by others are not covered by any warranty offered by Warming Trends.

No dealer, distributor, or other person has the authority to represent or warrant a Warming Trends™ product beyond the terms contained within this warranty, and Warming Trends™ assumes no liability for such warranty representations. Any questions concerning this warranty should be directed to the Warming Trends™ corporate office.

Return Policy of Warranty Product

Any Warming Trends™ product deemed by Warming Trends™ as defective and covered by the warranty may be returned to Warming Trends™ for assessment to determine if repair or replacement is necessary. In order to return a product, you must have a Return Merchandise Authorization number (RMA#). Please contact a Warming Trends™ representative at the corporate office to obtain an RMA#. All returned merchandise must have the RMA# clearly printed on the outside of the package. Return shipping costs are the purchaser's responsibility. Warming Trends™ is not responsible for product damaged or lost in transit. It is recommended that return items are shipped via a delivery service that can be tracked and/or insured to confirm receipt.

PROP 65 WARNING

What is "Prop 65"?

Proposition 65 ("Prop 65") is a California law which requires businesses to provide warnings to Californians about significant exposures to chemicals that cause cancer, birth defects or other reproductive harm. These chemicals can be in the products that Californians purchase, in their homes or workplaces, or that are released into the environment. Prop 65 enables Californians to make informed decisions about their exposures to these chemicals.

Prop 65 also prohibits California businesses from knowingly discharging significant amounts of listed chemicals into sources of drinking water.

Prop 65 requires California to publish a list of chemicals known to cause cancer, birth defects or other reproductive harm. This list, which must be updated at least once a year, has grown to include approximately 900 chemicals since it was first published in 1987.

Prop 65 became law in November 1986, and is also known as the Safe Drinking Water and Toxic Enforcement Act of 1986. Prop 65 does not apply to products sold outside of the state of California. For more info on Prop 65, go to: www.p65warnings.ca.gov For a fully updated list of all the chemicals and compounds that are known to the State of California to cause cancer or reproductive toxicity, go to: <https://oehha.ca.gov/proposition-65/proposition-65-list>.

Warnings

Lead: Can cause birth defects or other reproductive harm. Lead can be found in brass fittings. View the fact sheet at www.p65warnings.ca.gov

Carbon Monoxide: Carbon monoxide is a colorless, odorless, and poisonous gas. It is formed during the combustion of various fuels. View the fact sheet at www.p65warnings.ca.gov

Bisphenol A: BPA is a widely used chemical that be found in linings, plastics, and other materials. It can cause harm to the female reproductive system. View the fact sheet at www.p65warnings.ca.gov

Furniture Product Exposure: Some furniture products can expose you to chemicals which are known to the State of California to cause cancer or birth defects or other reproductive harm. View the fact sheet at www.p65warnings.ca.gov

Want to see more? View all of the Prop 65 fact sheets at www.p65warnings.ca.gov

More Info on Prop 65

If you have specific questions on the administration or implementation of Proposition 65, you can contact OEHHA's Proposition 65 program at P65.Questions@oehha.ca.gov, or by phone at (916) 445-6900.

For enforcement information, contact the California Attorney General's Office at (510) 622-2160, or visit <https://oag.ca.gov/prop65>.

Note: The information provided is for informational purposes only and does not constitute legal advice. If you have any concerns about Prop 65 or how it may apply to our products, please consult your attorney.

REPLACEMENT PARTS

FLKV12	½" Flex Line and Key Valve. For use with any burner up to 120K BTU's. Kit Includes: (1) 36" L x ½" Diameter Flex Line + ½" Key Valve + 3" and 12" Key		
FLKV34	¾" Flex Line and Key Valve. For use with any 121K - 249K BTU Burner. Kit Includes: (1) 36" L x ¾" Diameter Flex Line + ¾" Key Valve + 3" and 12" Key		
FLKV34FIT180	¾" Flex Line, Key Valve, and FIT180. For use with any 121K - 249K BTU Burner. Kit Includes: (1) 36" L x ¾" Diameter Flex Line + ¾" Key Valve + 3" and 12" Key + ½" x 2" Nipple to connect threaded inside ¾" Flex Line Flare Connector to ½" Plate Coupling		
DFLKV34	2x ¾" Flex Lines and Key Valve. For use with any burner over 249K BTU's. Kit Includes: (2) 36" L x ¾" Diameter Flex Lines with + ¾" Key Valve + 3" and 12" Key		
DFLKV34FIT250	2x ¾" Flex Line, Key Valve, and FIT250. For use with any burner over 249K BTU's. Kit Includes: (2) 36" L x ¾" Diameter Flex Lines + ¾" Key Valve + 3" and 12" Key + (1) ¾" x ½" MM Reducer Fitting and (1) ¾" Tee for connection at ½" Plate Coupling + (1) ¾" x 3" Nipple and (1) ¾" Tee for Key Valve connection		
DFLKV34FIT300	2x ¾" Flex Line, Key Valve, and FIT300. For use with any 300K+ BTU Burner. Kit Includes: (2) 36" L x ¾" Diameter Flex Lines + ¾" Key Valve + 3" and 12" Key + (1) ¾" x 3" Nipple and (1) ¾" Tee for connection at ¾" Plate Coupling + (1) ¾" Tee for Key Valve connection		
FIT180	Flex Line & Key Valve Connection Fitting for use with any burner over 249K BTU's. Kit includes: (1) ½" x 2" Nipple. Connects ½" Plate Coupling to inside threaded ¾" Flex Line Flare Connector		
FIT250	Flex Line & Key Valve Connection Fittings for 250K - 299K BTU Burner. Kit includes: (1) ¾" x ½" MM Reducer Fitting and (1) ¾" Tee for connection at ½" Plate Coupling + (1) ¾" x 3" Nipple and (1) ¾" Tee for Key Valve connection. Connects ½" Plate Coupling to two ¾" Flex Lines + connection of two ¾" Flex Lines to ¾" Key Valve.		
FIT300	Flex Line & Key Valve Connection Fittings for 300K+ BTU Burner. Kit includes: (1) ¾" x 3" Nipple and (1) ¾" Tee for connection at ¾" Plate Coupling + (1) ¾" x 3" Nipple and (1) ¾" Tee for Key Valve connection. Connects ¾" Plate Coupling to two ¾" Flex Lines and two ¾" Flex Lines to ¾" Key Valve.		
FL3612	36" L x ½" Diameter Flex Line (MM)	FL3634	36" L x ¾" Diameter Flex Line (MM)
KV12	½" Key Valve + 3" Key	KV34	¾" Key Valve + 3" Key
KEY3	3" Key	KEY12	12" Key
KEY24			24" Key
DRIPLEG12	½" Drip Leg Kit	DRIPLEG34	¾" Drip Leg Kit
LPRH	LP Regulator mounted on ¾" 10' Hose with handwheel quick connect. For use up to 125k BTU's. For Use with a 20LB propane tank		
LPHOSE10	LP ¾" 10' Hose. For use with a 20LB Propane Tank		
REGNG125	Regulator: 1/2" FNPT Inlet x ½" FNPT Outlet + For use up to 125K BTU's - Natural Gas		
REGLP140	Regulator: 1/4" FNPT Inlet x ¾" FNPT Outlet + For use up to 70K BTU's - Liquid Propane		
FPVK	Fire Pit Vent Kit: (2) 5.75" x 11.5" Vents + 18 square inches of vent area per vent		
PBIK	Push Button Ignition Kit: spark igniter rod and wire + push button battery operated control module		
PB-SI	Spark igniter rod and wire		
PB-CM	Push button battery operated control module		
MBR	Mounting Bracket		
3VIK-NG / 3VIK-LP	3V Ignition System		
3VCM	3V Control Module		
3VPA-NG / 3VPA-LP	3V Pilot Assembly (pilot tube + igniter + spark wire + igniter bracket + wind cage)		
3VGV-NG / 3VGV-LP	3V 120K BTU Capacity Gas Valve		
3VBP	3V Battery Pack		
24VIKHC-NG / 24VIKHC-LP	Standard 24V Ignition System (High Capacity)		
24VGVHC-NG / 24VGVHC-LP	24V 400K BTU Capacity Gas Valve (High Capacity)		
24VCM	24V Control Module for use with Standard Ignition Systems (SC & HC)		
24VPA-NG / 24VPA-LP	24V Pilot Assembly (pilot tube + igniter + spark wire + igniter bracket + wind cage) for use with Standard Ignition Systems (SC & HC)		
24VT	24 Volt Transformer for use with all 24 Volt Ignition Systems (Spark & Hot Surface Ignitions)		
P24VIKSC-NG / P24VIKSC-LP	Premium 24V Ignition System (Standard Capacity)		
P24VCBSC	Premium 24V 290K BTU Capacity Control Box (Standard Capacity)		
P24VIKHC-NG / P24VIKHC-LP	Premium 24V Ignition System (High Capacity)		
P24VCBHC	Premium 24V 512K BTU Capacity Control Box (High Capacity)		
P24VIKPA-NG / P24VIKPA-LP	Premium 24V Pilot Assembly (pilot tube + igniter + spark wire + igniter bracket + wind cage) for use with Premium Ignition Systems (SC & HC)		
P24VIKWC	Wind Cage		
P24VIKCGPA-NG / P24VIKCGPA-LP	24 Volt Hot Surface Ignition Pilot Assembly (Dual Pilot Tubes + Igniter + Igniter Bracket + Wind Cage) for use with Hot Surface Ignition Systems (Standard & High Capacity)		
P24VCBSCCG	24 Volt Hot Surface Ignition 290K BTU Standard Capacity Control Box with Dual Pilot Connections		
P24VCBHCCG	Premium 24 Volt 512K BTU High Capacity Control Box with Dual Pilot Connections		