

Proto3 - Through-Hole 0.1" Prototyping Board

Through-Hole Expansion Solder Points

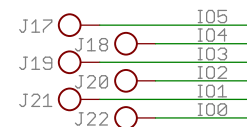

TinyShield Expansion - Bottom

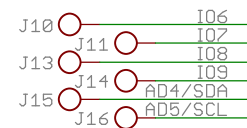
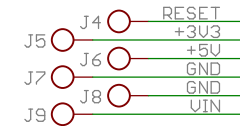
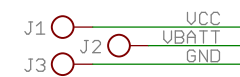
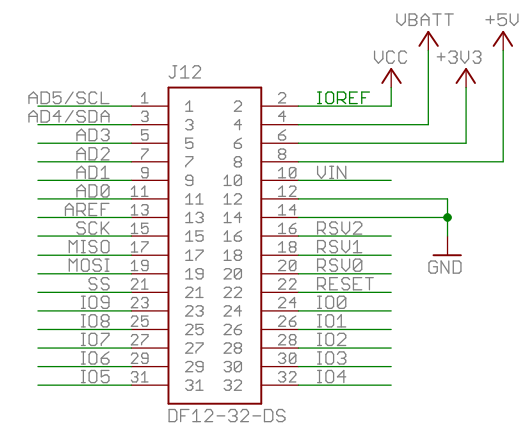

Released under the Creative Commons Attribution Share-Alike 3.0 License
<http://creativecommons.org/licenses/by-sa/3.0>

Original Arduino Uno Design by Team Arduino
 LilyPad Arduino Design by Leah Buechley and Sparkfun Electronics
 TinyDuino, TinyLily and TinyShield Designs by TinyCircuits

 http://www.Tiny-Circuits.com	
TITLE: TinyShield - Proto3	
Document Number: AS-SCH-ASD2004	REV: 2
Date: 7/7/2013 9:51:14 PM	Sheet: 1/1