



TRANSITIONAL

ELBA

AMERICAN CHERRY

Its essence is casual comfort made unique by wide framed wood doors with smoked glass inserts.

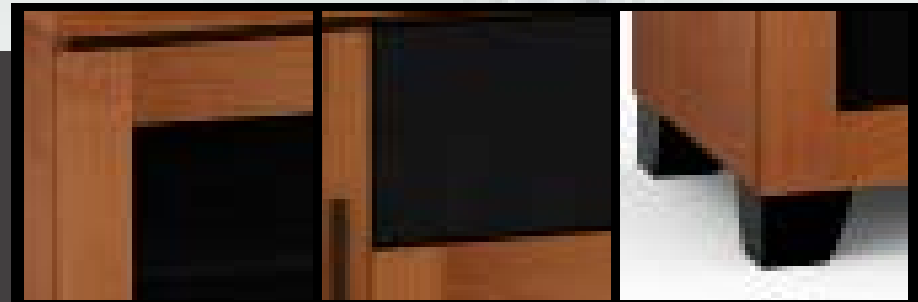

Solid Wood Framed
Smoke Glass Doors

Brown Speaker Grill

Black Tapered Solid Wood Feet
with Hidden Adjustable Leveler



ELBA

AMERICAN CHERRY

CONTEMPORARY

CHAMELEON COLLECTION



Elba 217 23.25"W x 24.5"H x 21.25"D
Single Cabinet | C/EL217/AC
Subwoofer Enclosure | C/EL217SE/AC



Elba 317 23.25"W x 33.75"H x 21.25"D
Single Cabinet | C/EL317/AC
Rack Mount Cabinet | C/EL317RM/AC



Elba 517 23.25"W x 53.625"H x 21.25"D
Single Cabinet | C/EL517/AC
Rack Mount Cabinet | C/EL517RM/AC



Elba 617 23.25"W x 63.25"H x 21.25"D
Single Cabinet | C/EL617/AC
Rack Mount Cabinet | C/EL617RM/AC



Elba 221 44"W x 24.5"H x 21.25"D
Twin Cabinet | C/EL221/AC



Elba 221 Corner 44"W x 24.5"H x 21.25"D
Twin Corner Cabinet | C/EL221CR/AC



Elba 329 44"W x 33.75"H x 21.25"D
Twin Cabinet | C/EL329/AC



Elba 329 Corner 44"W x 33.75"H x 21.25"D
Twin Corner Cabinet | C/EL329CR/AC



Elba 323 44"W x 33.75"H x 21.25"D
Twin Cabinet | C/EL323/AC
Rack Mount Cabinet | C/EL323RM/AC



Elba 323 Corner 44"W x 33.75"H x 21.25"D
Twin Corner Cabinet | C/EL323CR/AC



Elba 236 64.75"W x 24.5"H x 21.25"D
Triple Cabinet | C/EL236/AC9



Elba 237 64.75"W x 24.5"H x 21.25"D
Triple Cabinet | C/EL237/AC



Elba 336 64.75"W x 33.75"H x 21.25"D
Triple Cabinet | C/EL336/AC



Elba 337 64.75"W x 33.75"H x 21.25"D
Triple Cabinet | C/EL337CR/AC



Elba 339 64.75"W x 33.75"H x 21.25"D
Triple Cabinet | C/EL339/AC



Elba 245 88.5"W x 24.5"H x 21.25"D
Quad Cabinet | C/EL245/AC



Elba 247 85.5"W x 33.75"H x 21.25"D
Quad Cabinet | C/EL247/AC



Elba 345 85.5"W x 33.75"H x 21.25"D
Quad Cabinet | C/EL345/AC



Elba 347 85.5"W x 33.75"H x 21.25"D
Quad Cabinet | C/EL347/AC

CR - Corner
RM - Rack Mount, Pro Audio
SUB - Subwoofer Enclosure
W - Wall Mountable
Speaker Integration



INTERIOR SPECIFICATIONS

A - Single-Width Compartment

19.75"W x 19.5"D x 17.75"H

B - Single-Width Compartment

19.75"W x 19.5"D x 27.75"H

C - Media Drawer

18.625"W x 18"D x 7.75"H

holds 75 DVD's and or 111 CD's upright

D - Single-Width Center Speaker / Multi-Functional Compartment

19.75"W x 19.5"D x 9"H

G - Double-Width Center Speaker / Multi-Functional Compartment

40.5"W x 19.5"D x 9"H

F - Triple-Width Center Speaker / Multi-Functional Compartment

61.25"W x 19.5"D x 9"H

J - Double-Width Compartment

40"W* x 19"D* x 17.5"H

H - Double-Width Compartment

40"W* x 19"D* x 27.75"H



217
SUBWOOFER ENCLOSURE
Includes Rear Speaker Grill



217
Rec. TV Size: up to 32"
Top Holds: 350 lbs

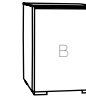

317
Rec. TV Size: up to 32"
Top Holds: 350 lbs

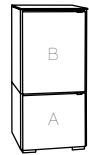

517
Rec. TV Size: up to 32"
Top Holds: 350 lbs

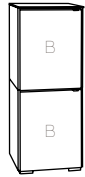

617
Rec. TV Size: up to 32"
Top Holds: 350 lbs

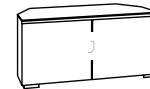

212 CORNER
Rec. TV Size: up to 46"
Top Holds: 350 lbs

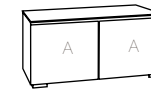

221
Rec. TV Size: up to 46"
Top Holds: 350 lbs

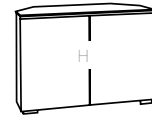

323 CORNER
Rec. TV Size: up to 46"
Top Holds: 350 lbs

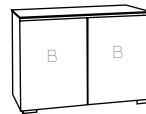

323
Rec. TV Size: up to 46"
Top Holds: 350 lbs

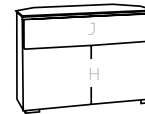

329 CORNER
Rec. TV Size: up to 46"
Top Holds: 200 lbs

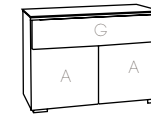

329
Rec. TV Size: up to 32"
Top Holds: 200 lbs

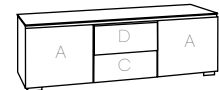

236
Rec. TV Size: up to 65"
Top Holds: 350 lbs

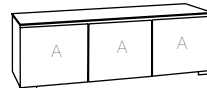

237
Rec. TV Size: up to 65"
Top Holds: 350 lbs

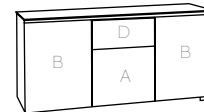

336
Rec. TV Size: up to 65"
Top Holds: 350 lbs

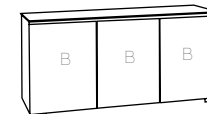

337
Rec. TV Size: up to 65"
Top Holds: 350 lbs

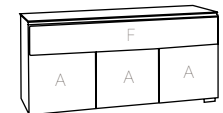

339
Rec. TV Size: up to 65"
Top Holds: 150 lbs

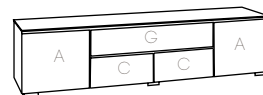

245
Rec. TV Size: up to 70"+
Top Holds: 350 lbs

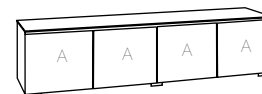

247
Rec. TV Size: up to 70"+
Top Holds: 350 lbs

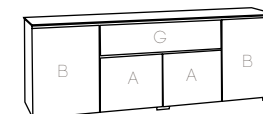

345
Rec. TV Size: up to 70"+
Top Holds: 350 lbs

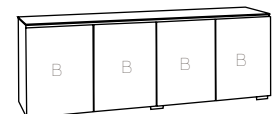

347
Rec. TV Size: up to 70"+
Top Holds: 350 lbs

INTERIOR SPECIFICATIONS

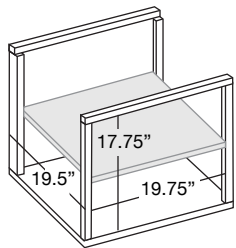

A

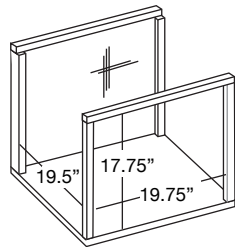

A1

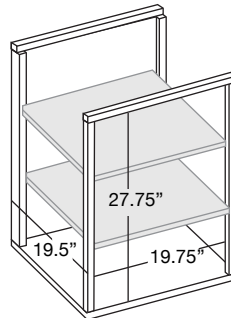

B

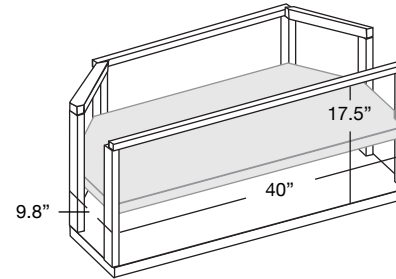

J

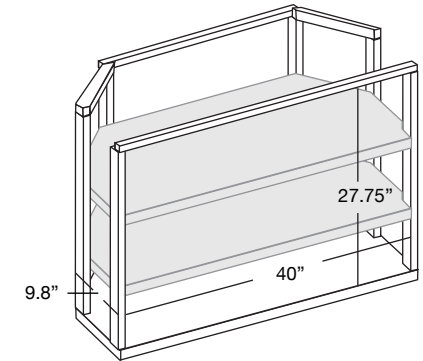

H

CORNER INTERIOR

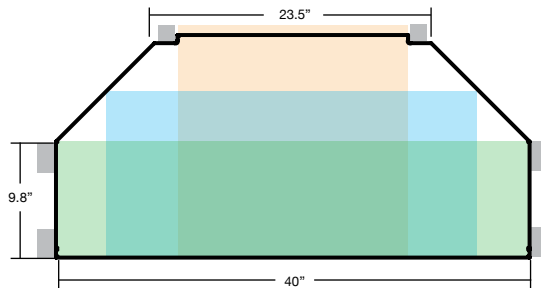

- 40" wide x 10" deep
- 32" wide x 14" deep
- 19" wide x 20" deep

CORNER EXTERIOR

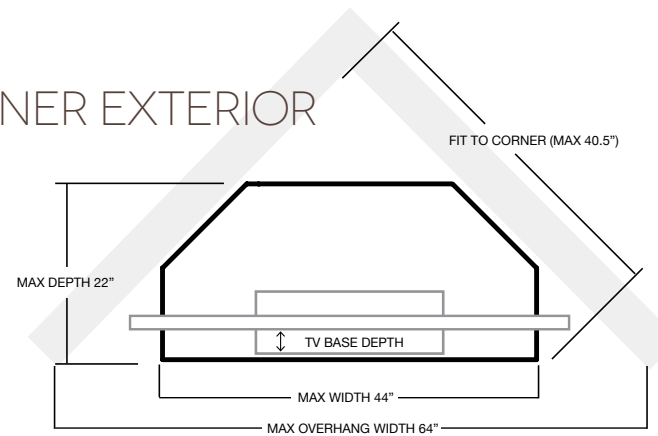

TV SIZING:

For every 1" of depth required by the TV base, subtract 1.8 from 64. This is the MAX TV width at the required depth. Note: Minor gains can be had by moving cabinet forward. This will cause a gap but will produce 1.8" in width per inch moved forward.